

---

# ADVANCED PATTERNS

Origamic Architecture Vol. II

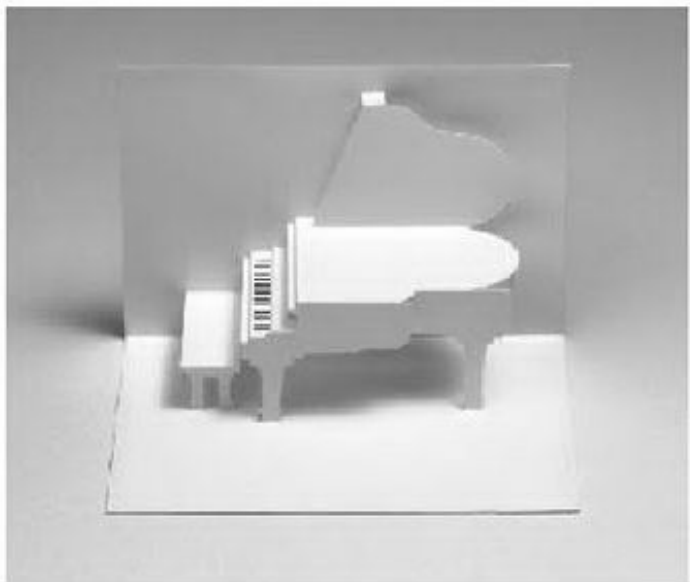

*Step by Step Instructions!*

# ADVANCED PATTERNS

## Origamic Architecture Vol. II

### TABLE OF CONTENTS

JUGGLER

PAGE 6

CIRCUS RIDER

PAGE 18

BUTTERFLY

PAGE 8

VIKING SHIP

PAGE 20

PALM TREES

PAGE 10

WEDDING CAKE

PAGE 22

GRAND PIANO

PAGE 12

BOUQUET OF FLOWERS

PAGE 24

SANTE FE HOME

PAGE 14

HOT AIR BALLOON

PAGE 26

LADY BUG

PAGE 16

SINGLE STEM ROSE

PAGE 28

# Tools you'll need

---

## Graphic knife or scalpel.

I use X-acto blades and knives, but some people prefer scalpels. Make sure the blades are SHARP. Dull blades cause accidents! I also prefer the "grip" handles.



## Burnisher or bone folder.

You will need some tool for making the crease scores. Bone folders work nicely (some letter openers work). I use a ball-pointed burnisher for my creases.



## Transparent or masking tape.



## A metal straightedge.

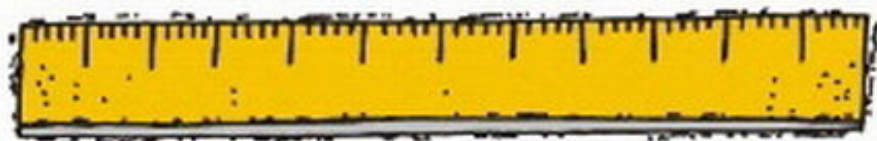

## Light table.

A portable light table is all that's necessary. If you don't have one, you can tape your sheets of paper to a window. Be sure to add an extra sheet or two to prevent the glass from getting scratched! I use a lap-style light table with a plexiglass top.

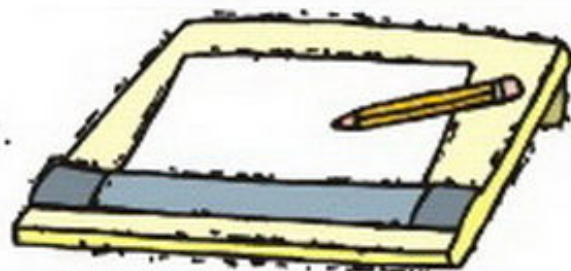

# Techniques

Blue lines indicate a  
CREASE or VALLEY FOLD.  
Use your burnisher/bone folder.

Red lines indicate a  
Cut score or MOUNTAIN FOLD.  
Cut halfway through the paper.

Black lines indicate a  
Full cut through the paper.

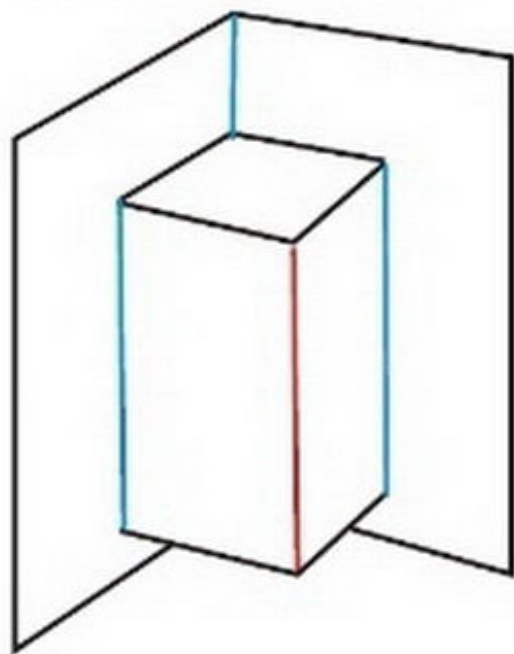

80 lb. Cover or Index  
is a good weight to use  
and is available at any  
office supply store.

When cutting a point, make two  
separate cuts, approaching the  
sharpest point from both directions.

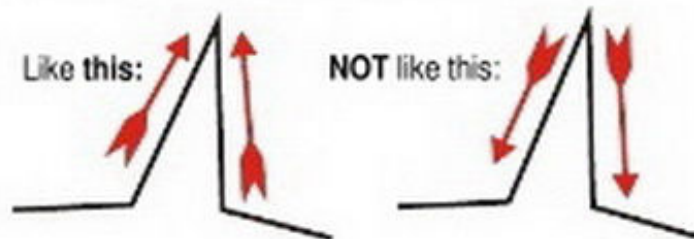

**To get the page ready for cutting:**

Go to the page of the design you want.  
Click print (current page). Tape the printed  
pattern to the back of the blank sheet you  
will be cutting/decorating. This is superior  
to taping all the sheets to the light table,  
as you can now rotate the paper instead  
of making you cut with an awkward  
arrangement of the hands and arms  
(another source of bad cutting and  
accidents!)

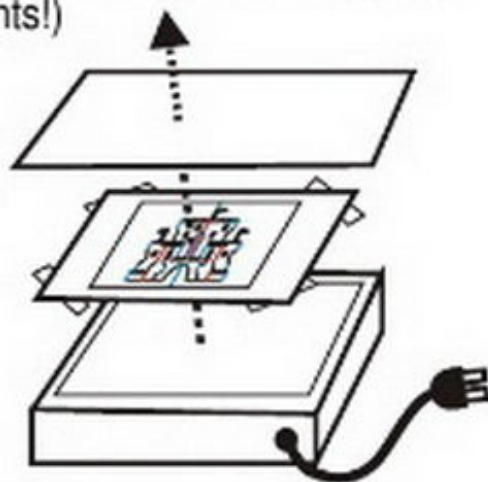

# Juggler

DIFFICULTY  
LEVEL



## tips&tricks

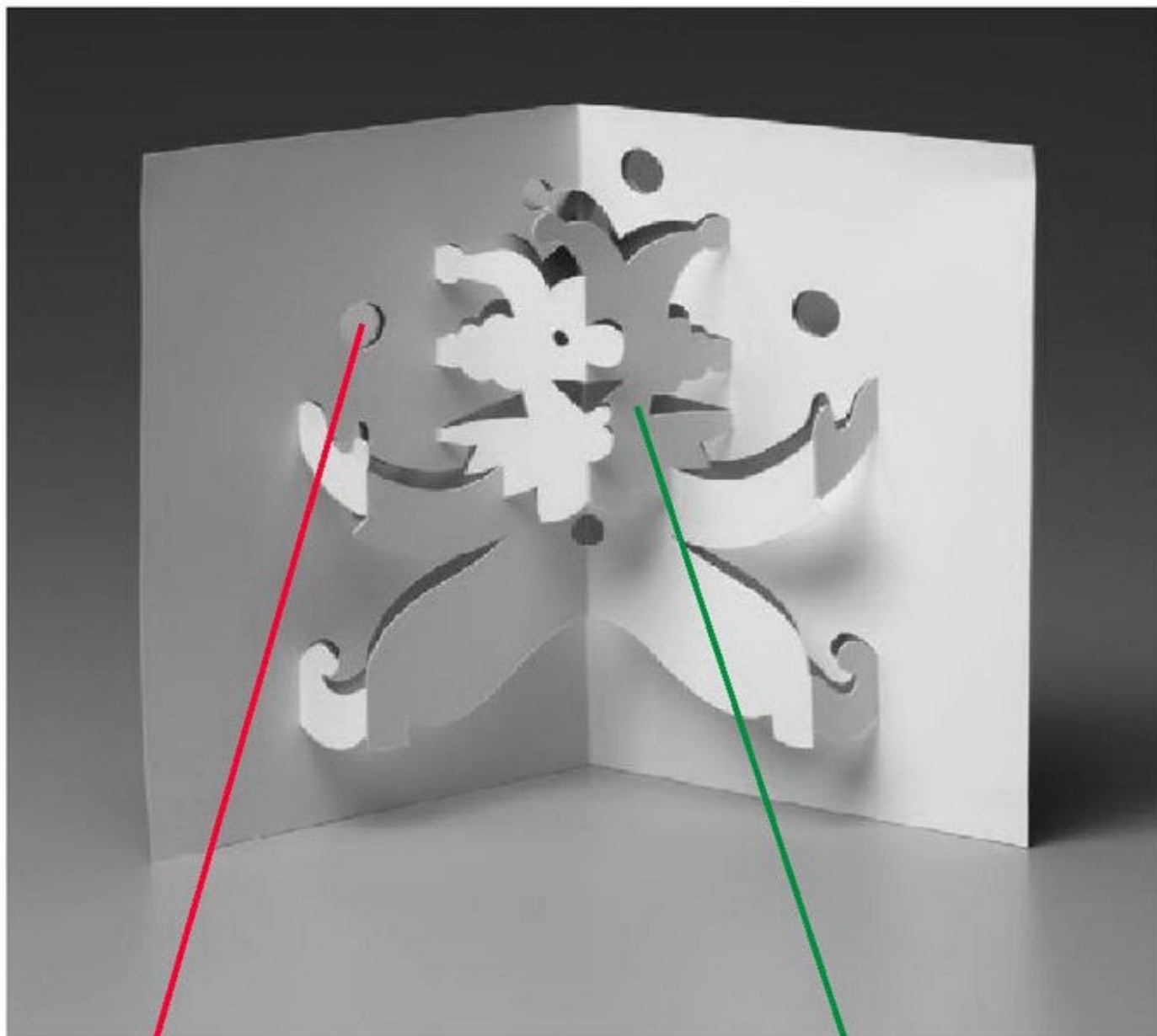

Use a punch or circle template to make the balls nice and round.

Have fun and make your own faces!

■ RED=cut halfway through ■ BLUE=score ■ BLACK=cut through

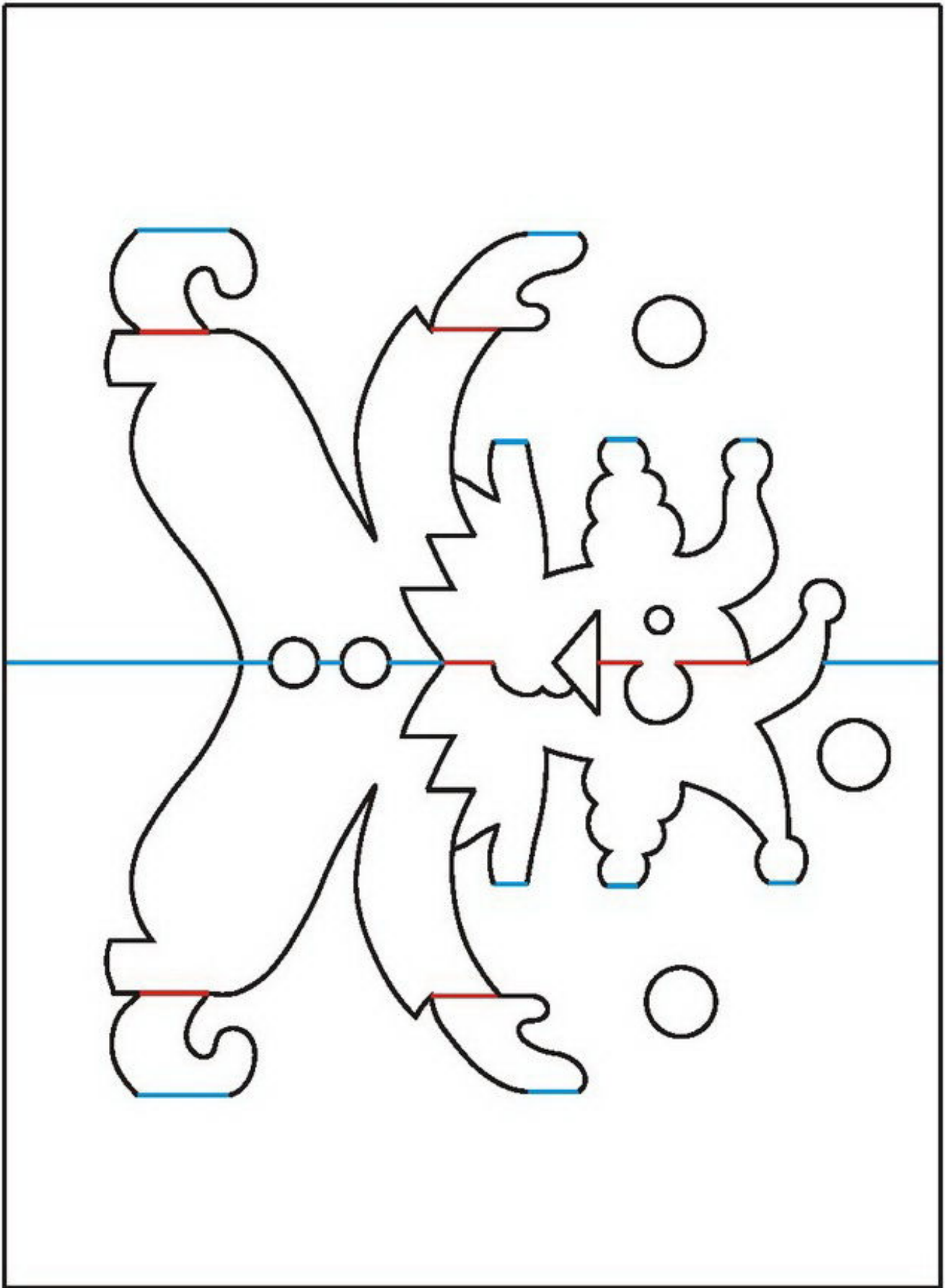

# Butterfly

DIFFICULTY  
LEVEL



## tips&tricks

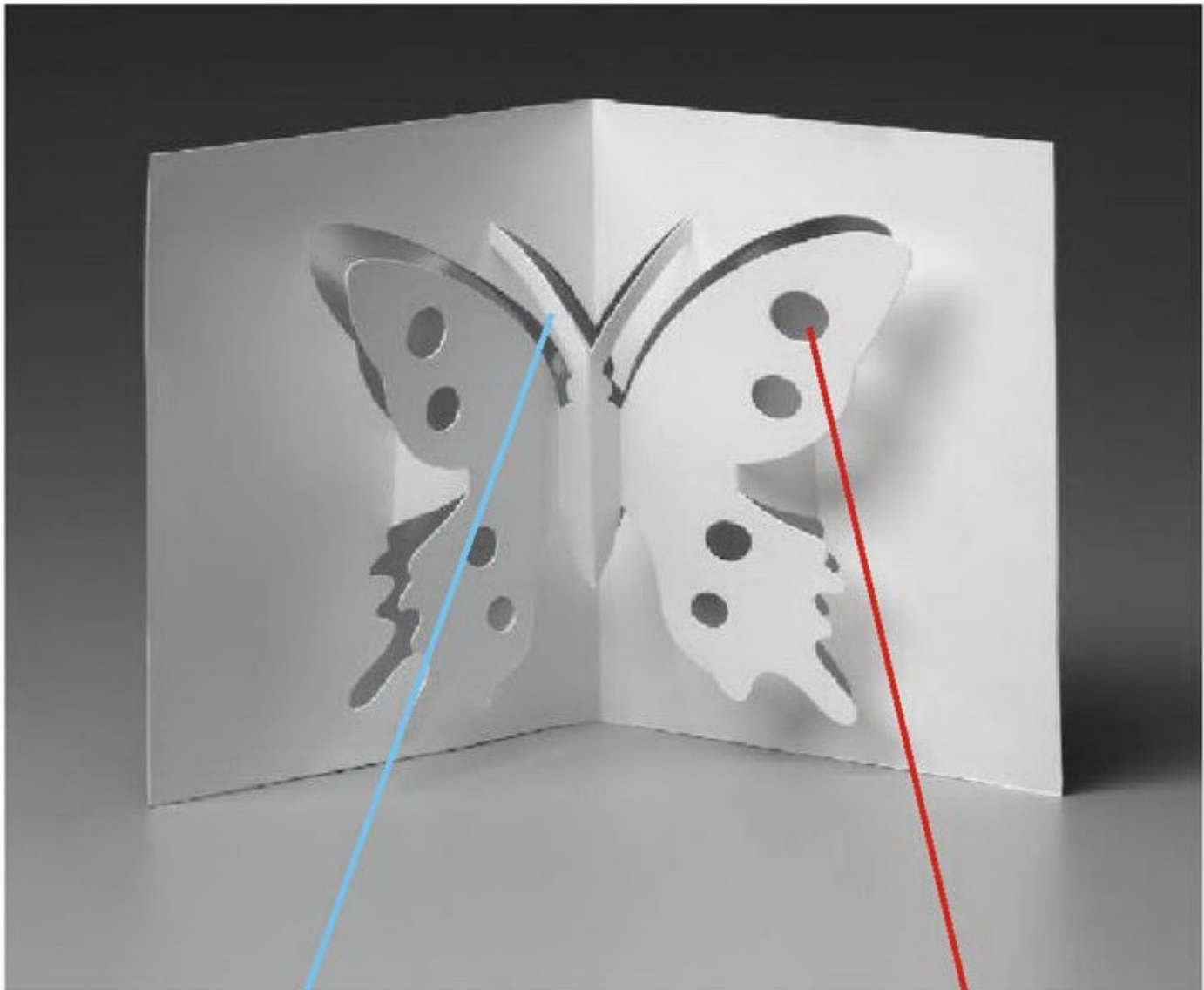

Be careful with the antennae. They are the weakest part of the structure. Use tweezers to make the folds if necessary.

Different sized punches make perfect circles.

■ RED=cut halfway through ■ BLUE=score ■ BLACK=cut through

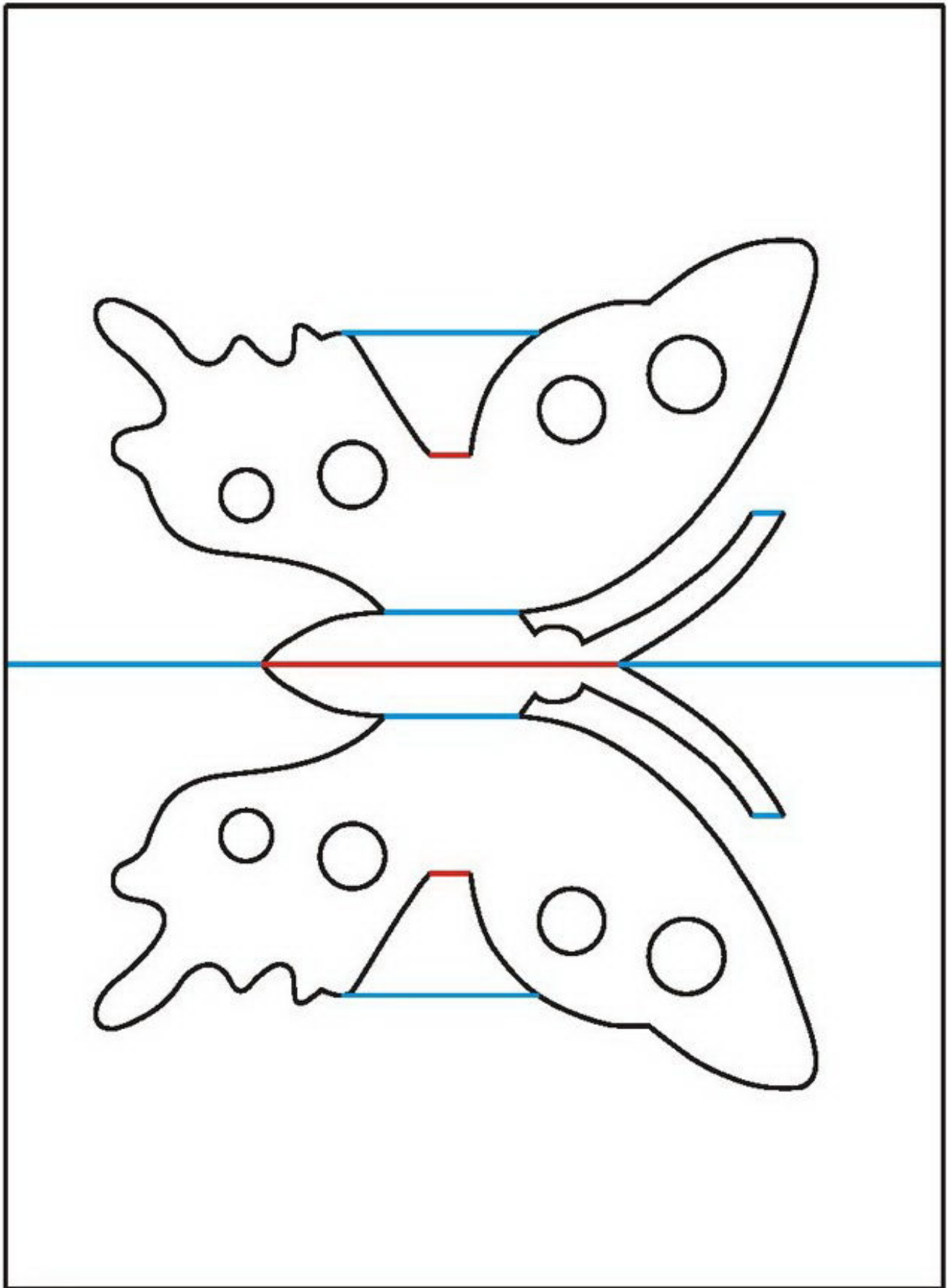



# Palm Trees

DIFFICULTY  
LEVEL



## tips&tricks

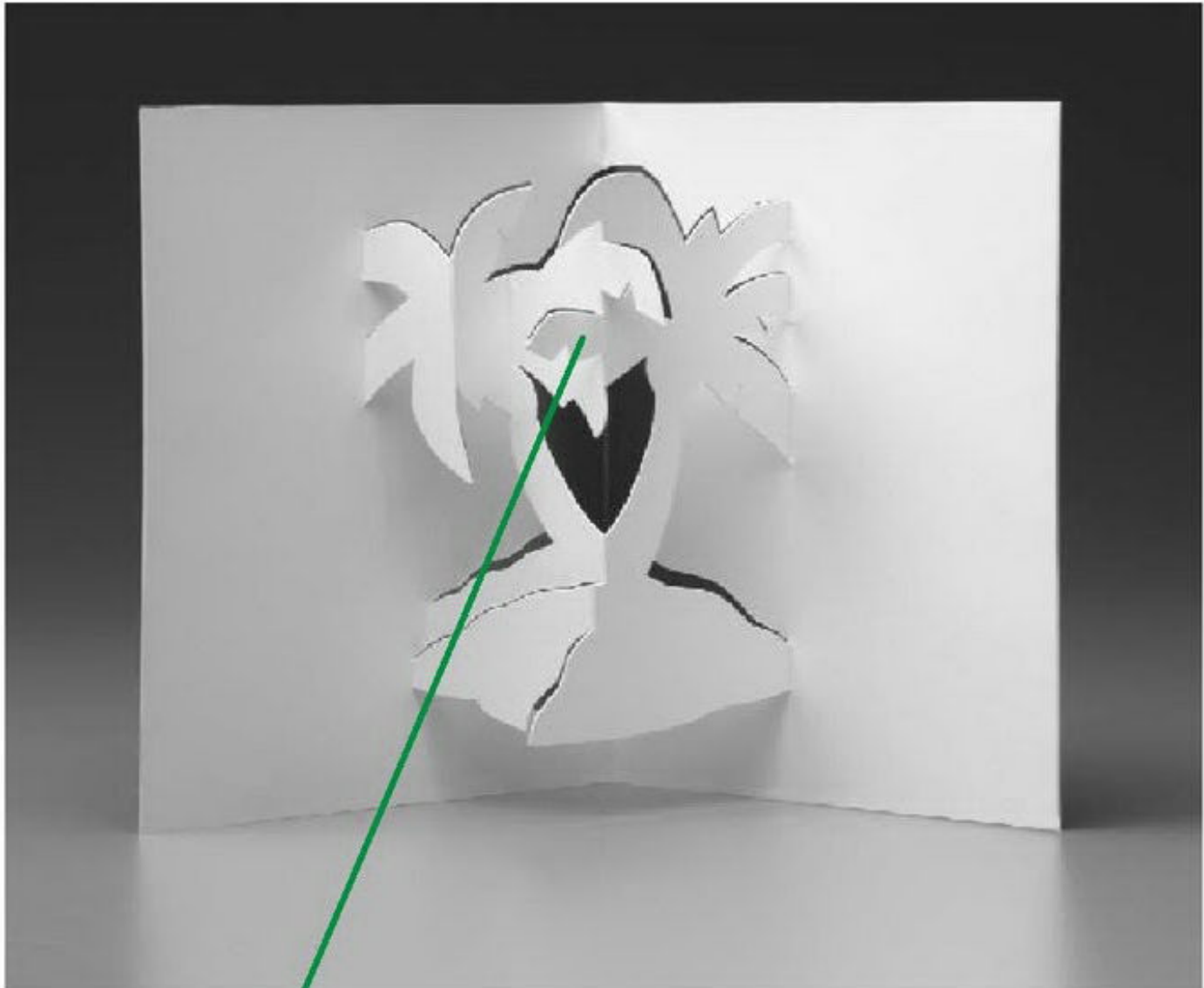

The two leaves facing front are the most fragile. Be careful when making the cuts not to cut all the way through.

■ RED=cut halfway through ■ BLUE=score ■ BLACK=cut through

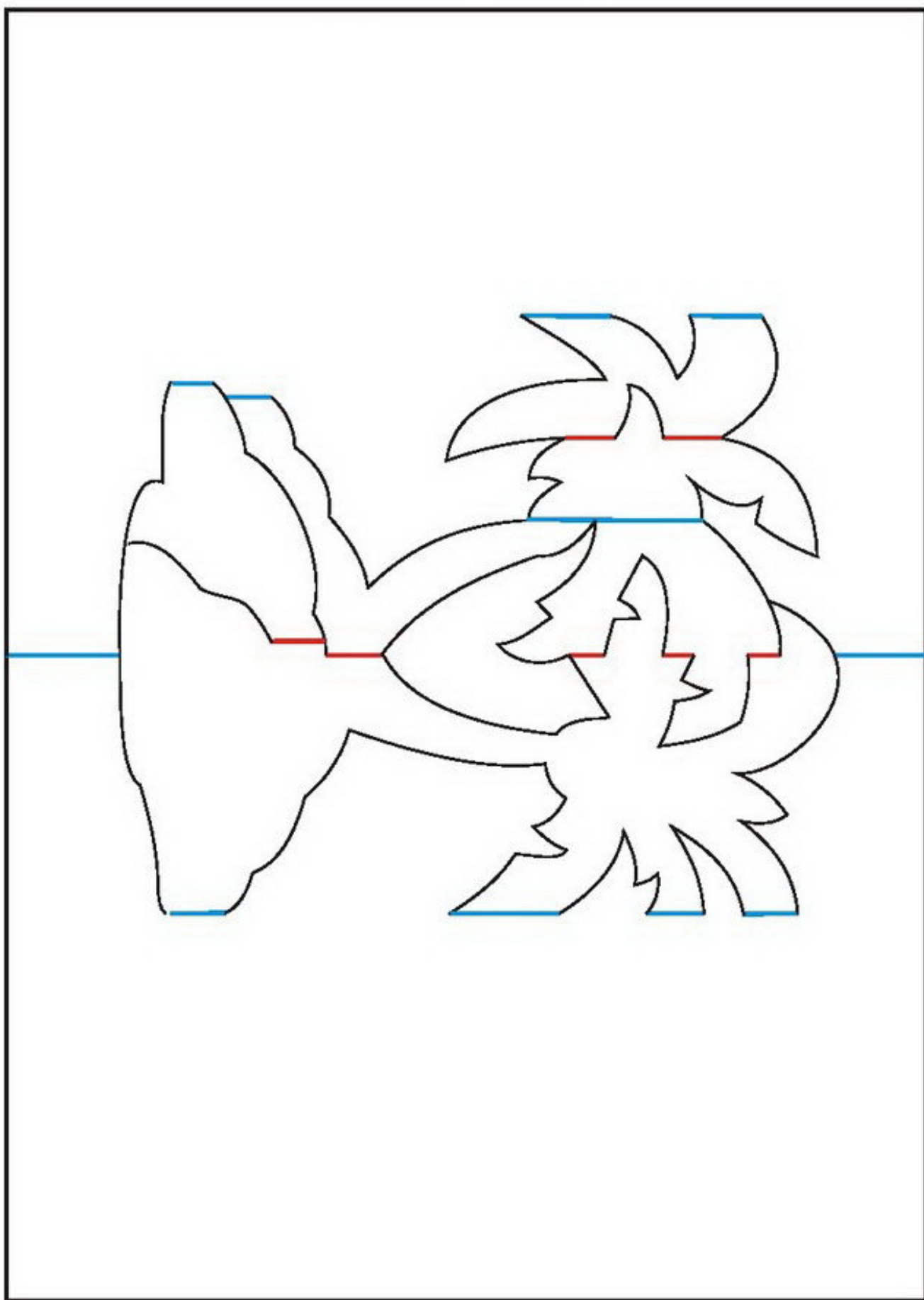

# Grand Piano

DIFFICULTY  
LEVEL



## tips&tricks

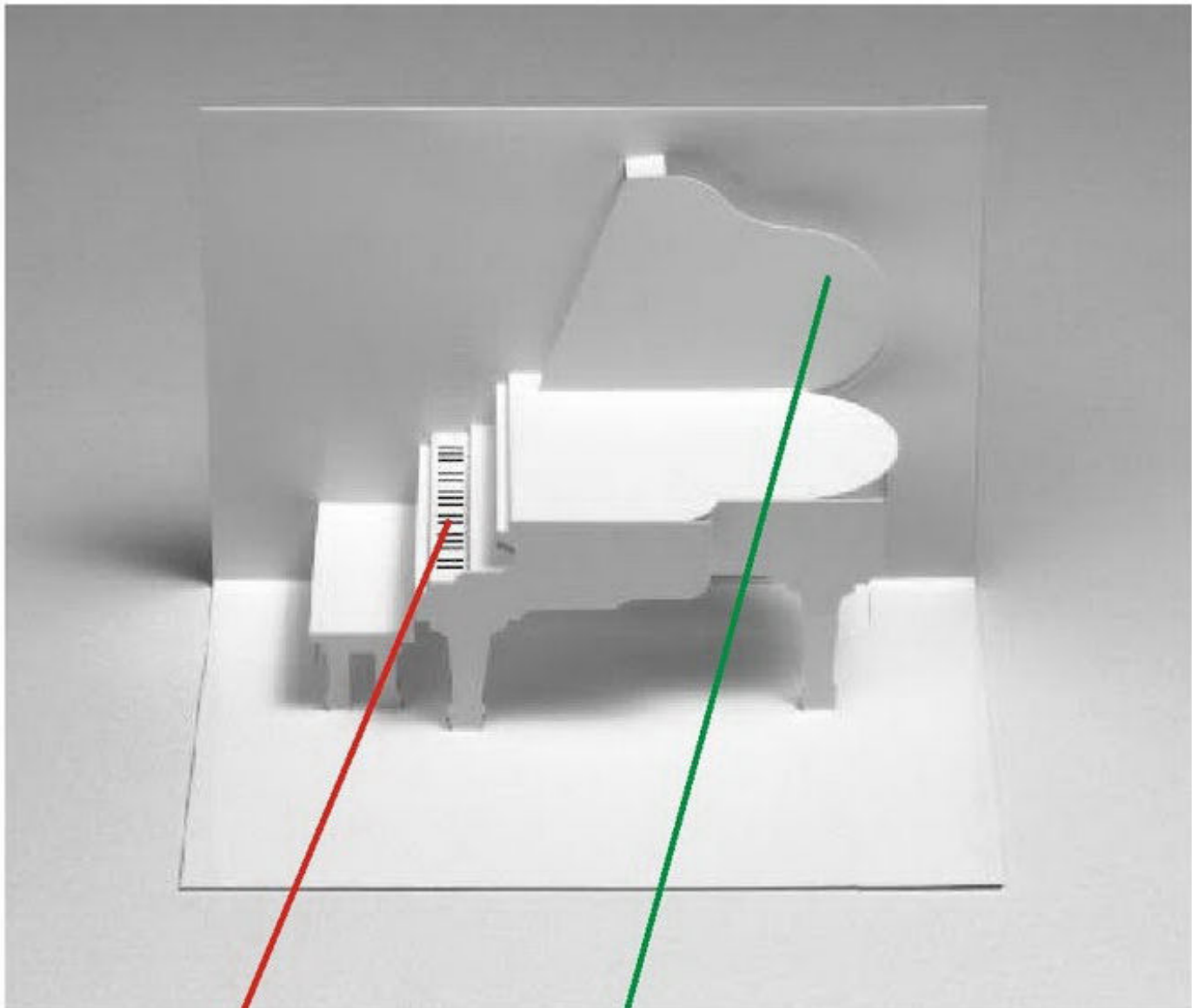

Draw the keys on with a straightedge. Only draw the black keys!

Cut the large curves using a fluid stroke. Turn the paper while cutting to avoid putting your hand in an awkward position.

■ RED=cut halfway through ■ BLUE=score ■ BLACK=cut through

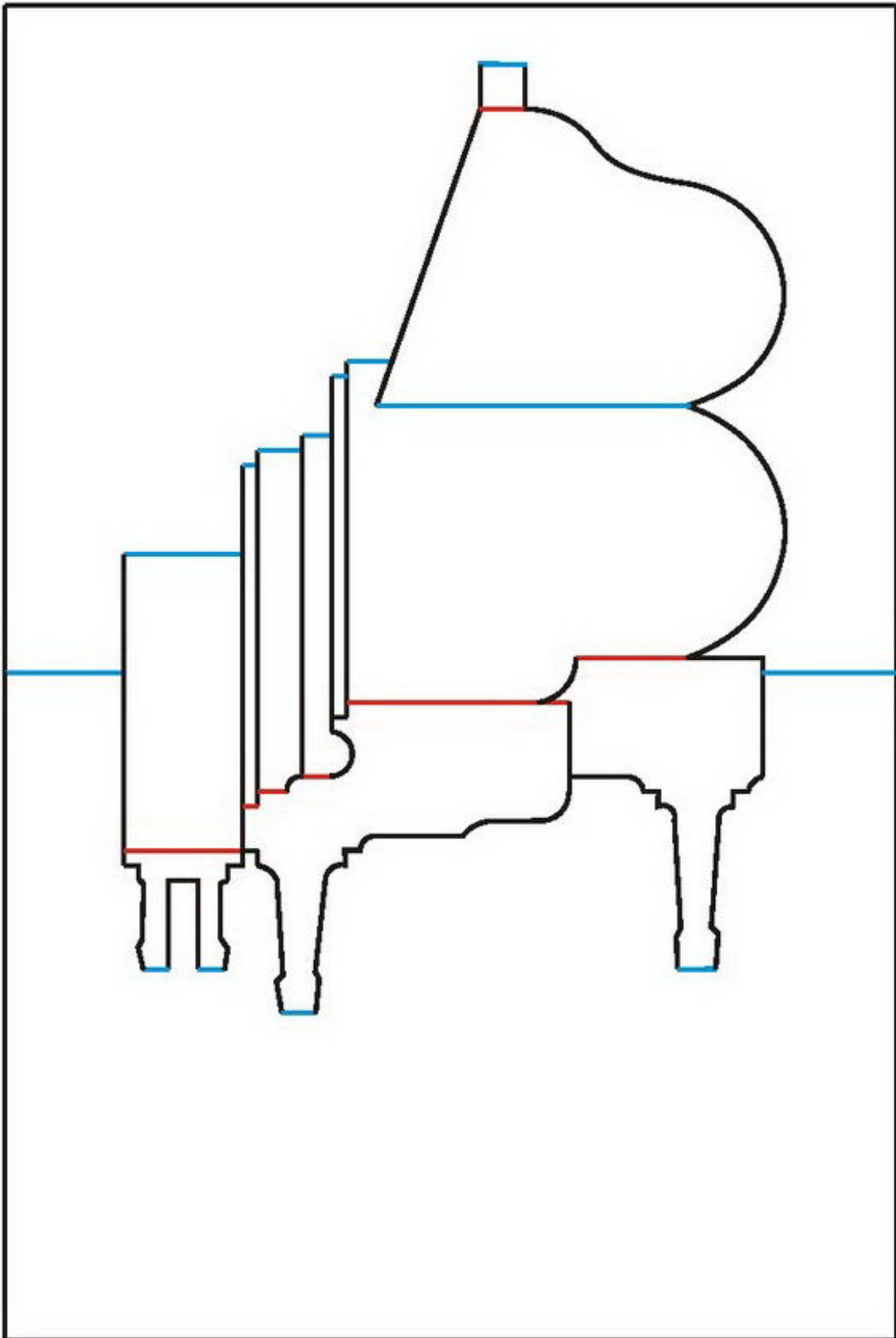

# Santa Fe Home

DIFFICULTY  
LEVEL



tips&tricks

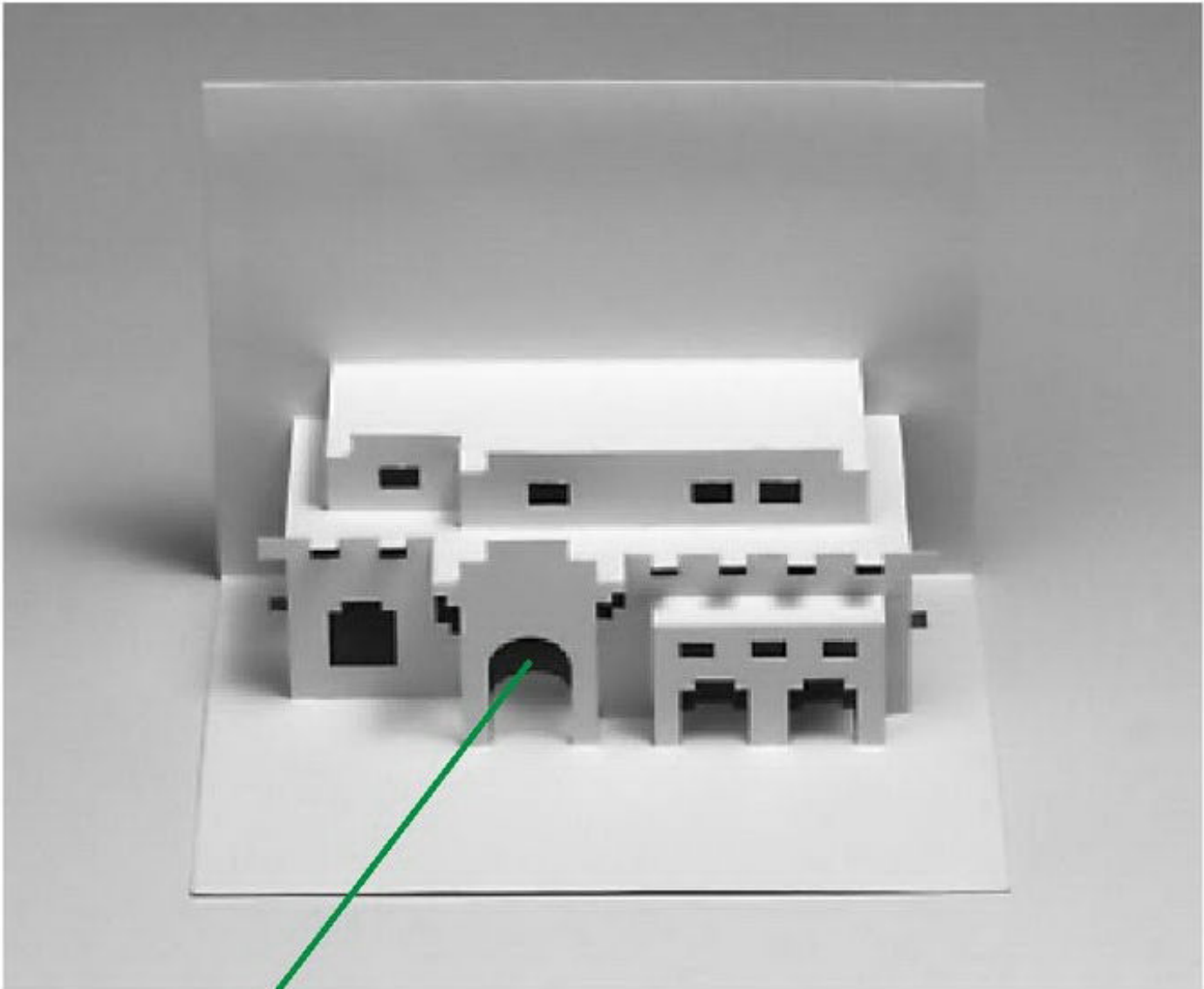

This is an easy design (only one curve!), But looks nice!

■ RED=cut halfway through ■ BLUE=score ■ BLACK=cut through

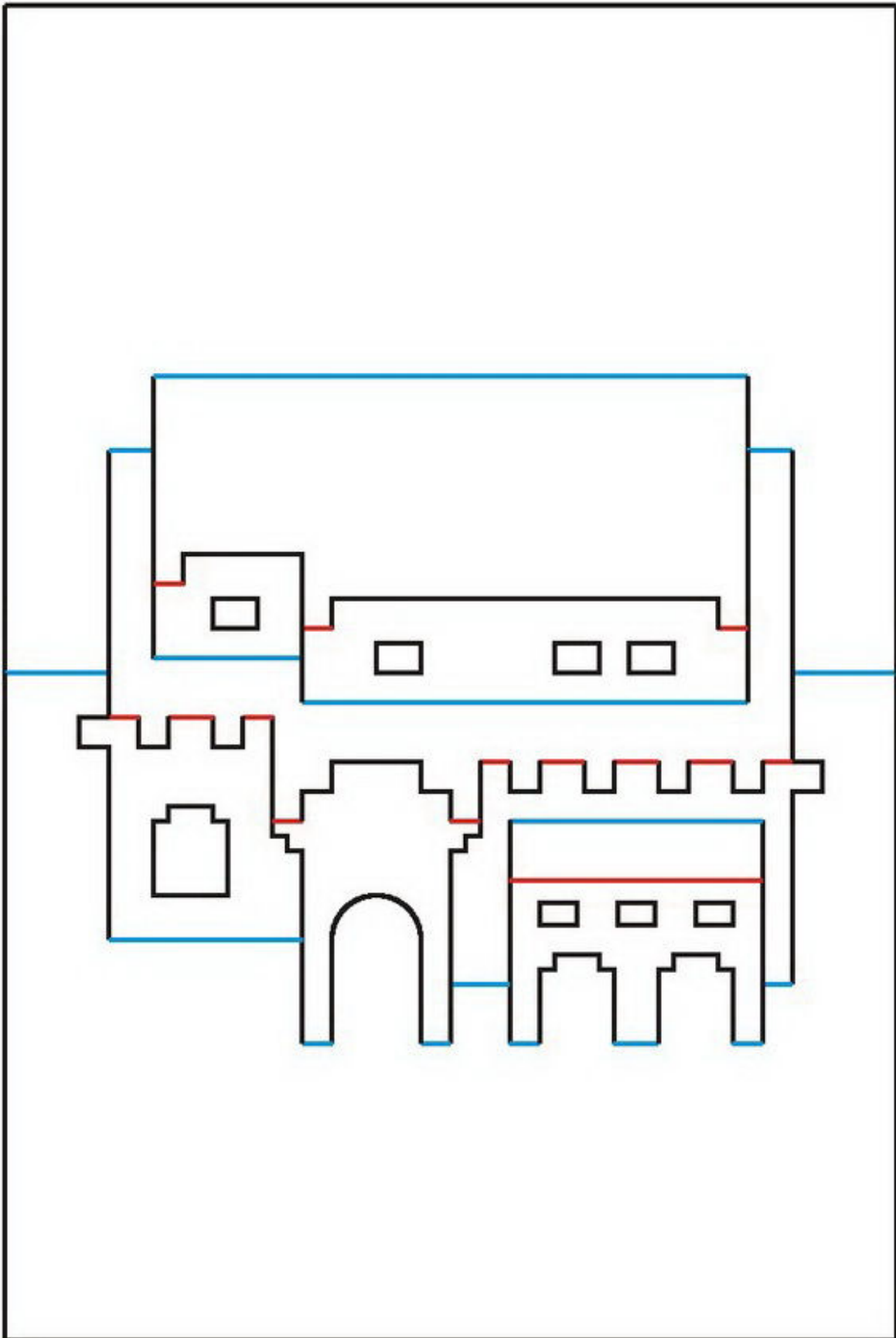

# Lady Bug

DIFFICULTY  
LEVEL



## tips&tricks

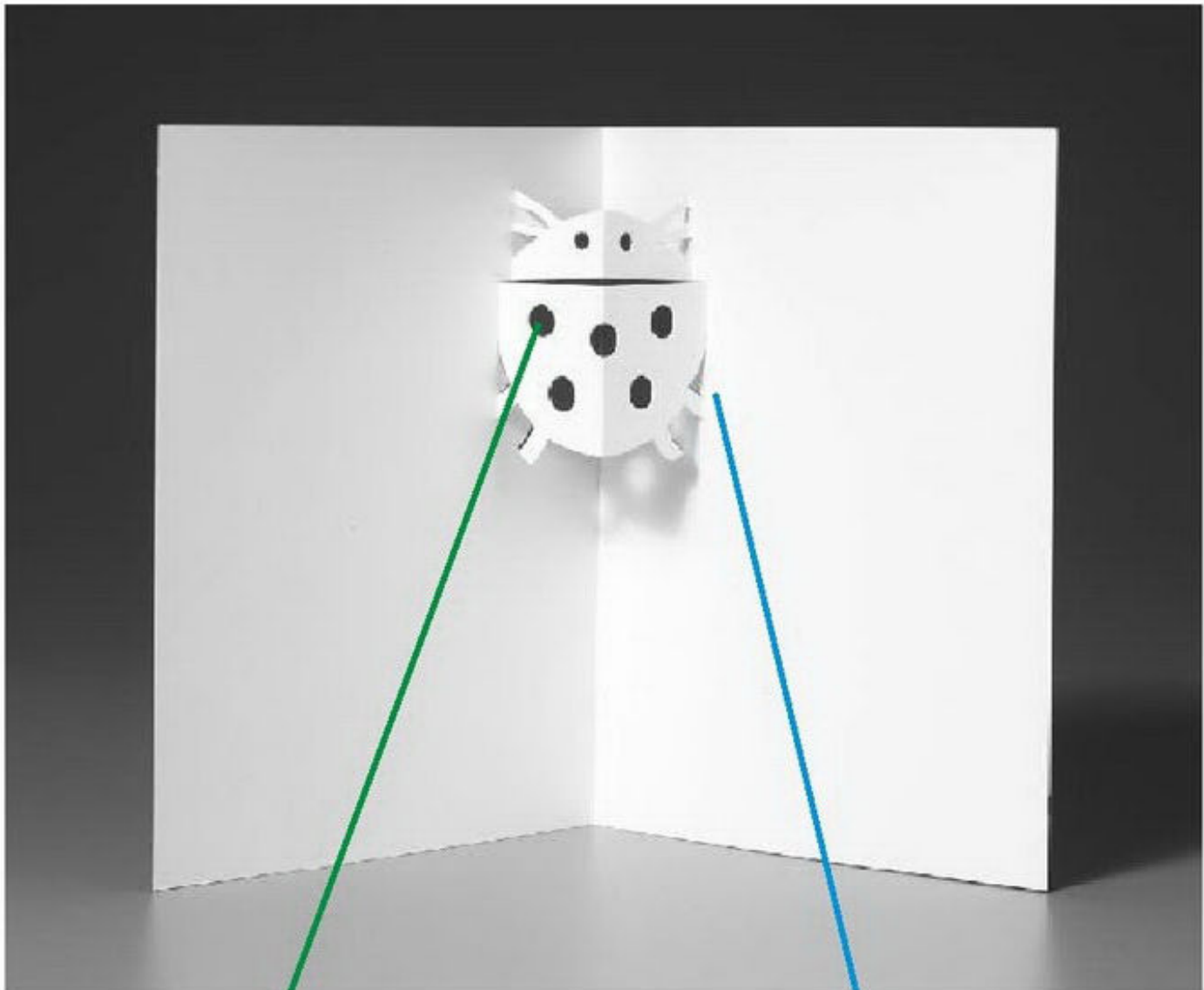

As always, use a punch for the circles.

When folding, push in this area in front of the back legs with the tip of a burnisher or toothpick.

■ RED=cut halfway through ■ BLUE=score ■ BLACK=cut through

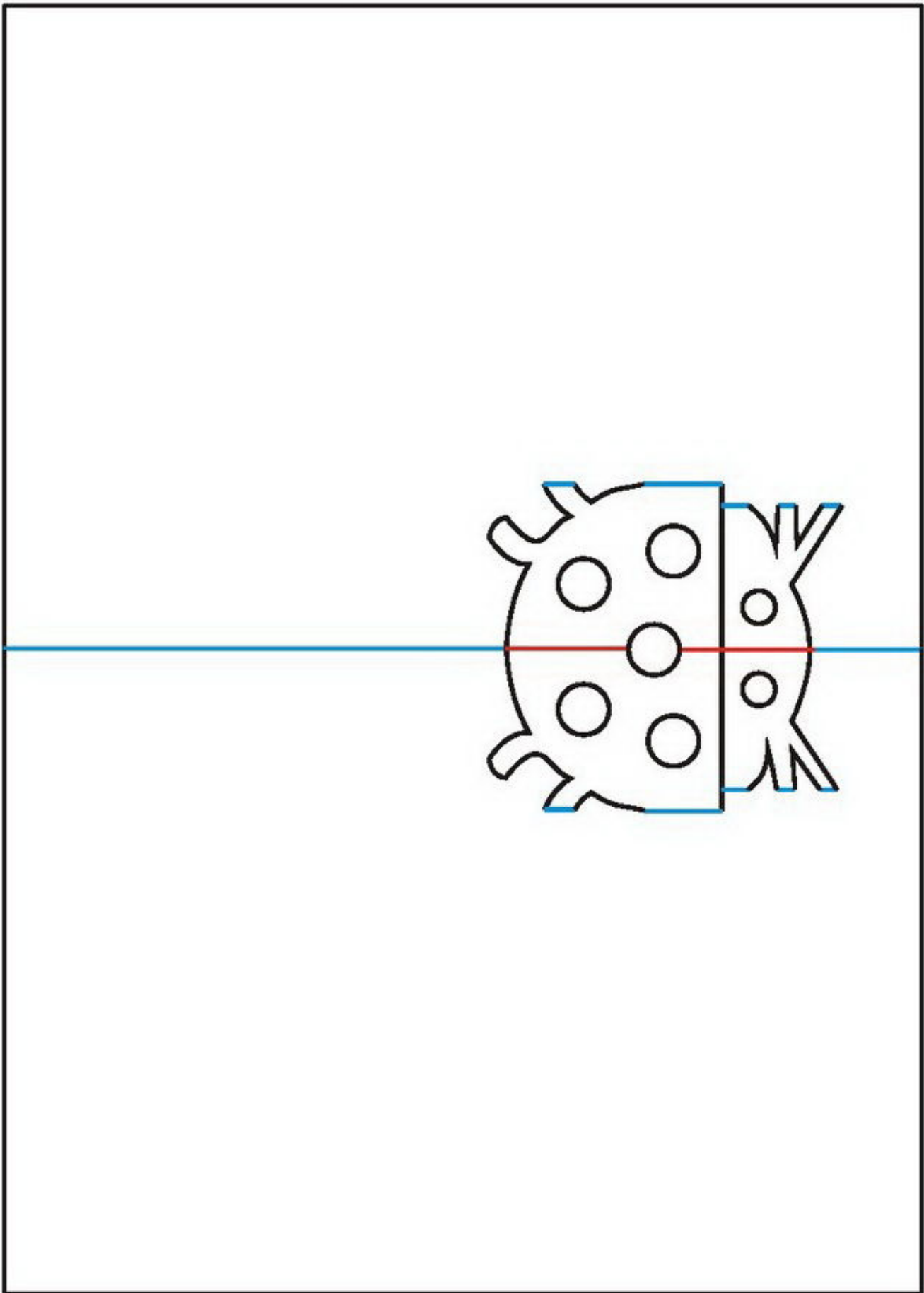



# Circus Rider

DIFFICULTY  
LEVEL



## tips&tricks

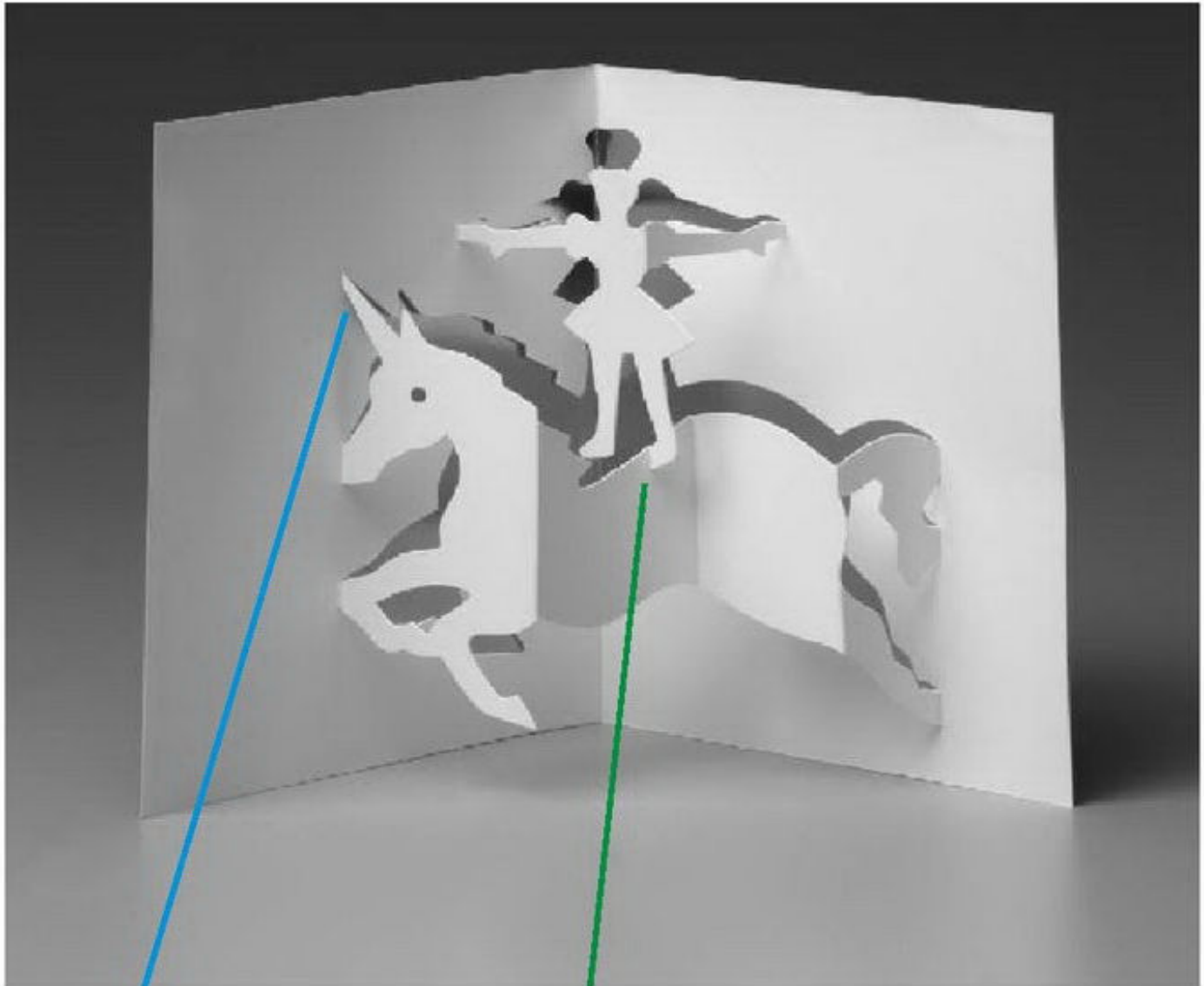

You can extend or eliminate this horn to turn the unicorn into a horse!

This foot is the only connection of horse and rider. Make sure it is straight or the rider will tip one way or another.

■ RED=cut halfway through ■ BLUE=score ■ BLACK=cut through

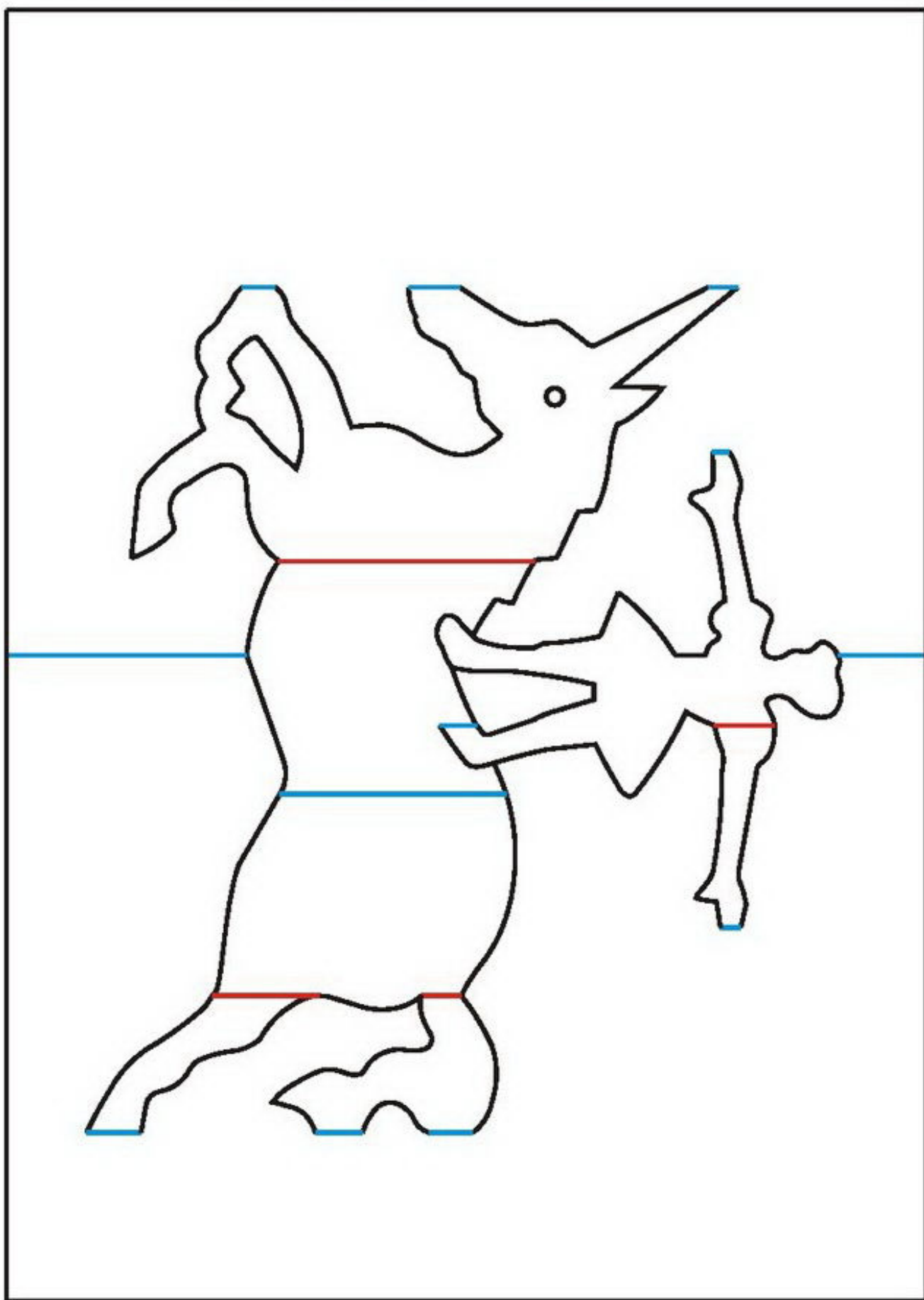

# Viking Ship

DIFFICULTY  
LEVEL



## tips&tricks

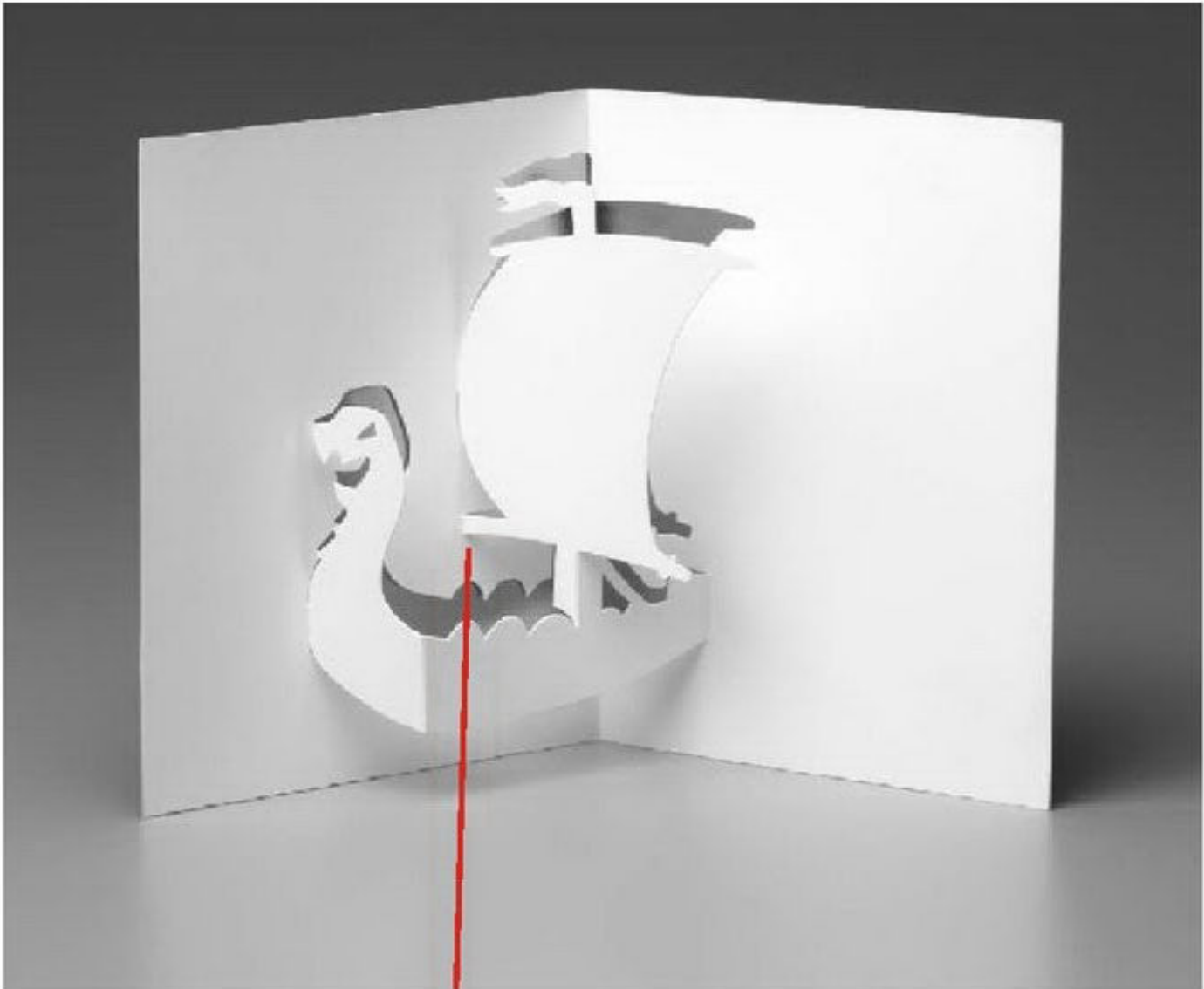

Don't cut through the bottom of this sail...  
It may be hard to see from the pattern,  
but this connects to the backing.

■ RED=cut halfway through ■ BLUE=score ■ BLACK=cut through

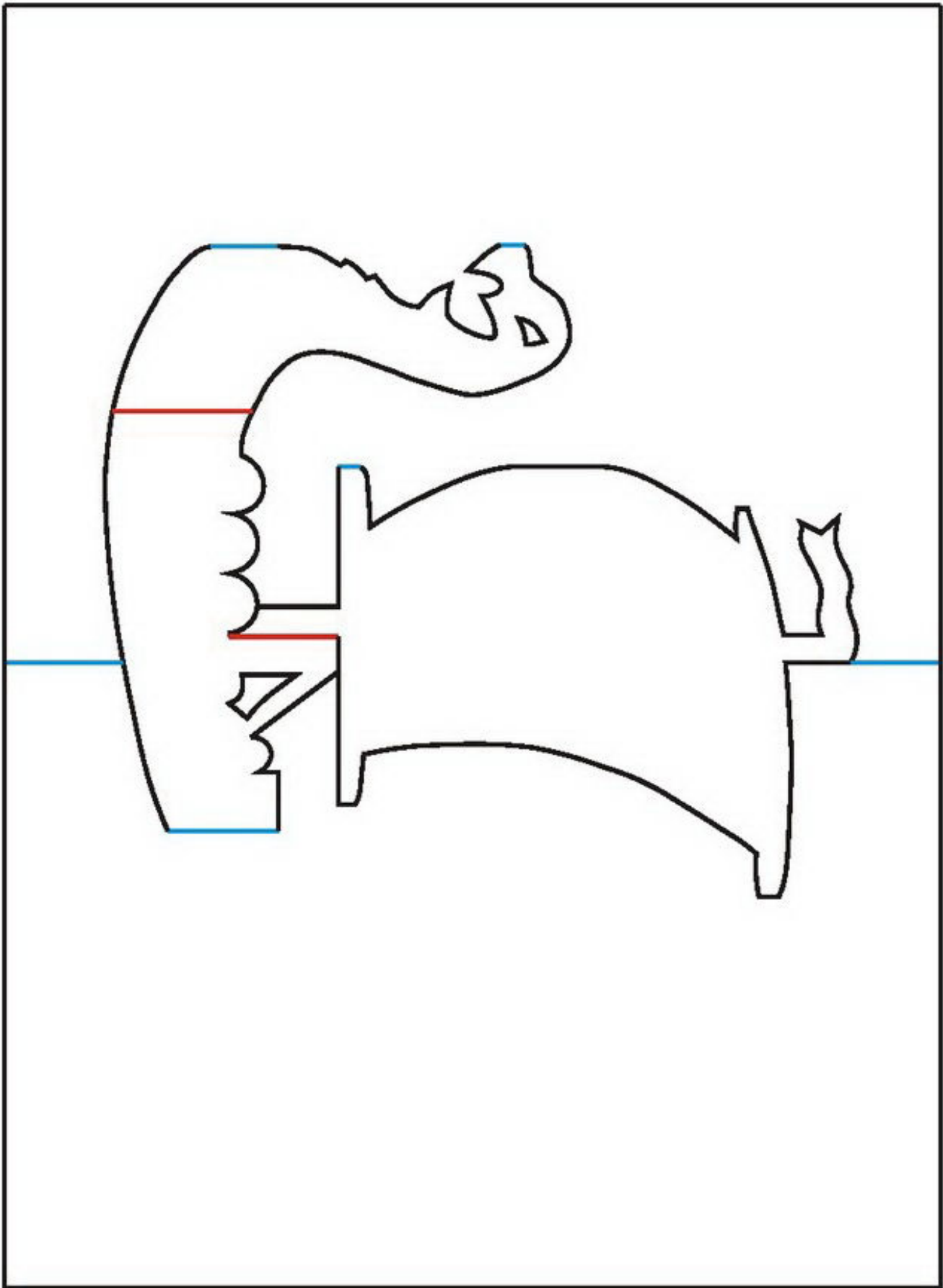

# Wedding Cake

DIFFICULTY  
LEVEL



## tips&tricks

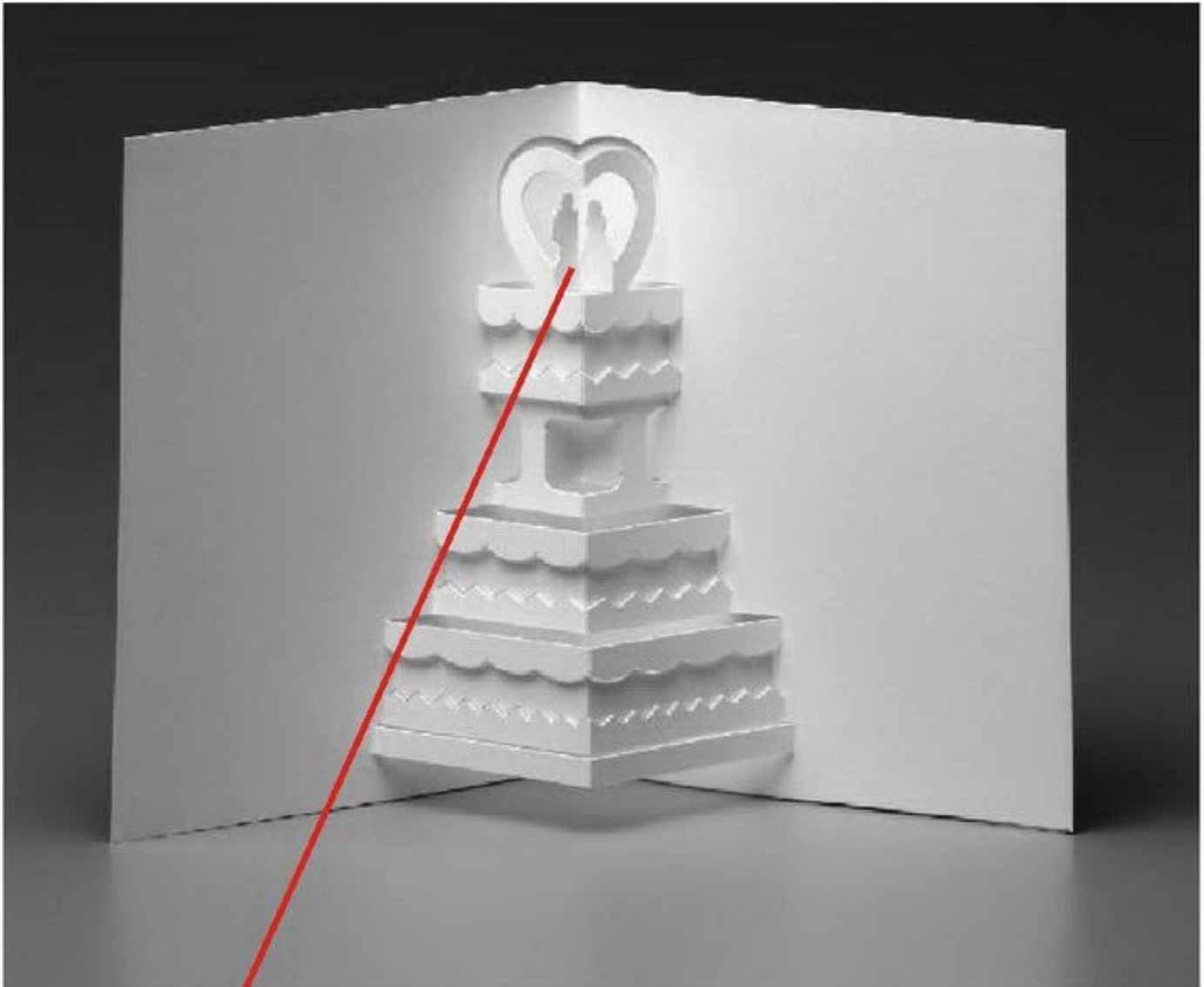

The figures on the top are the most difficult part of this design. Use a sharp x-acto and be careful!

■ RED=cut halfway through ■ BLUE=score ■ BLACK=cut through

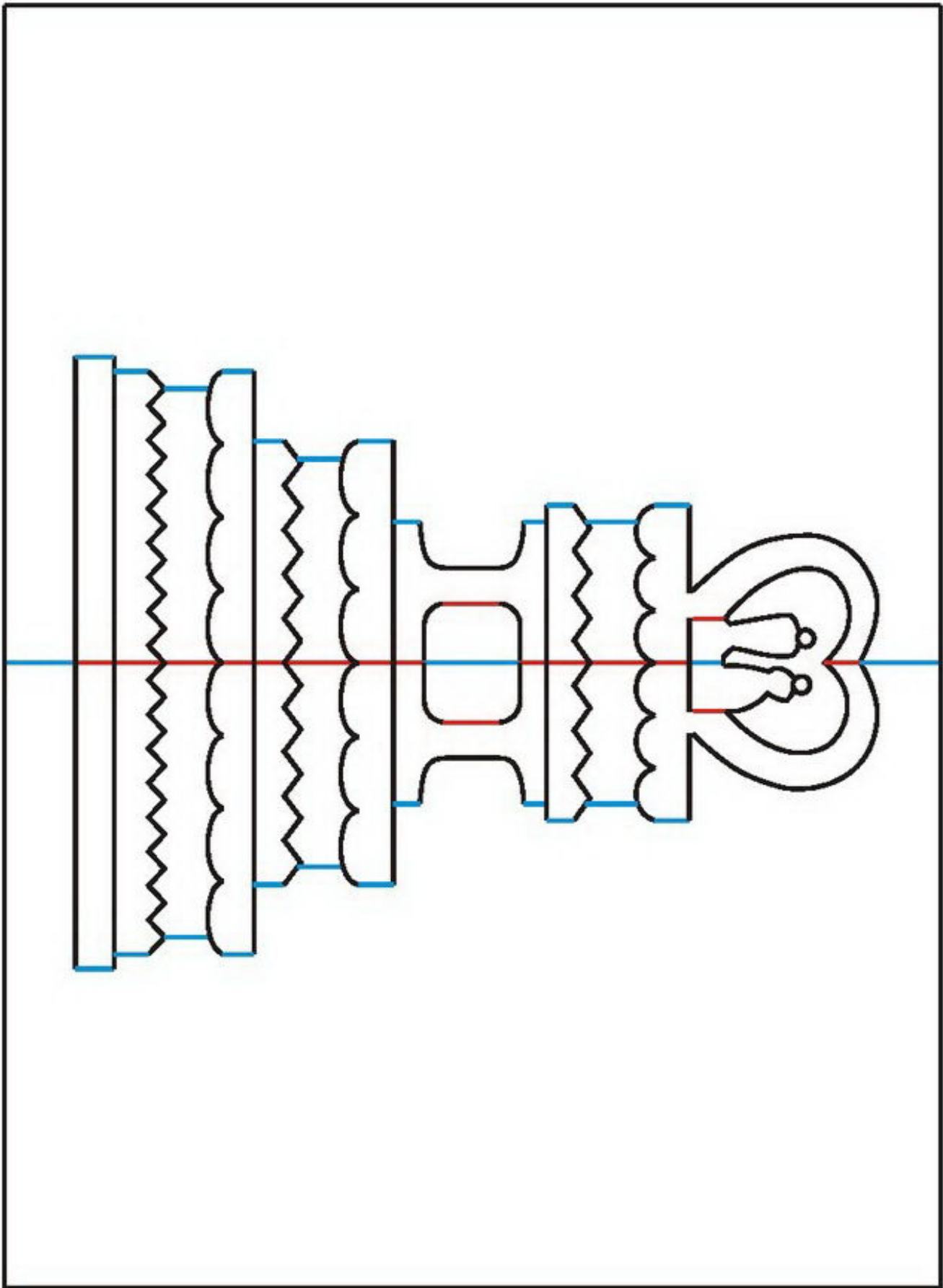

# Bouquet of Flowers

DIFFICULTY  
LEVEL



tips&tricks

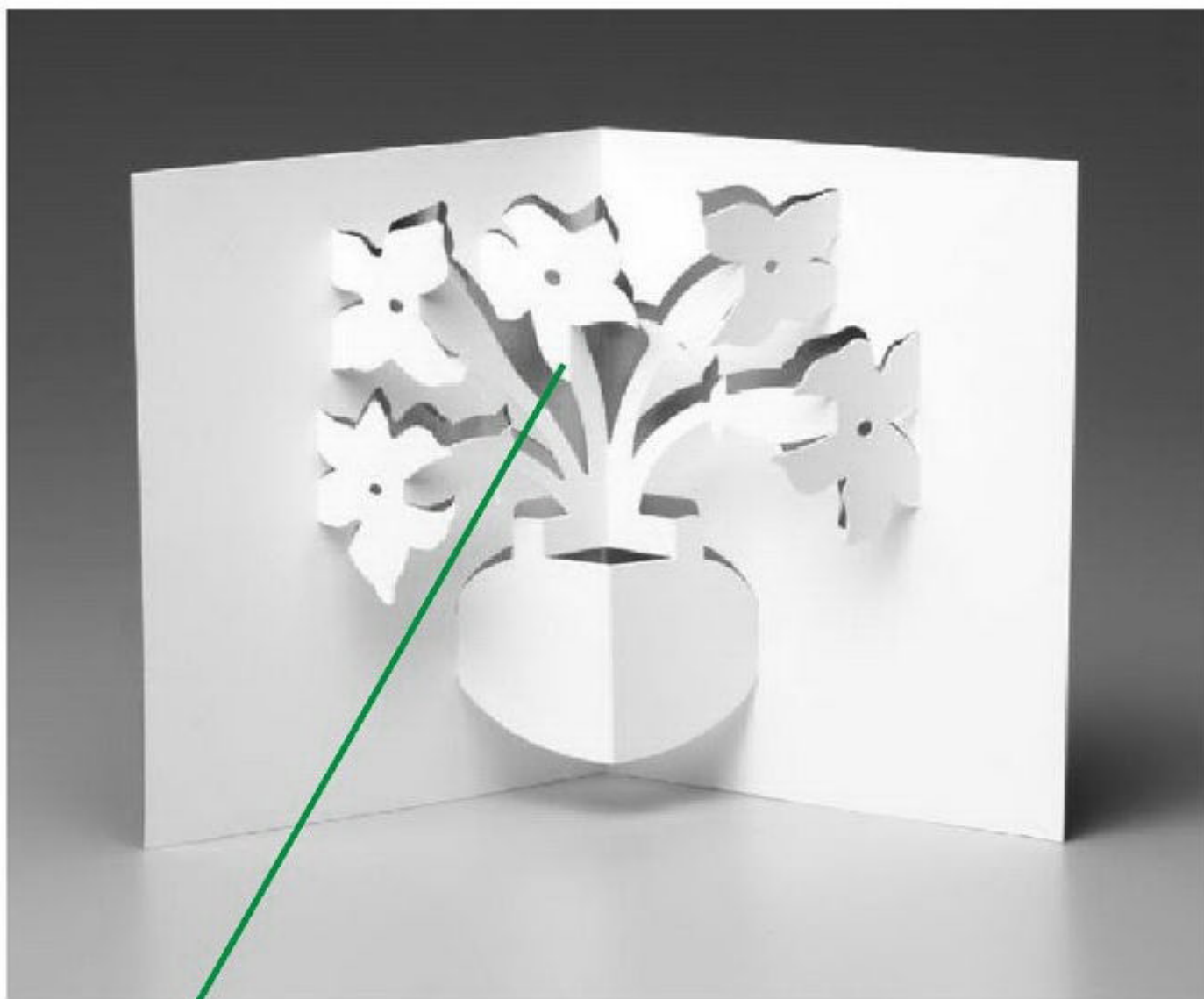

This short cut-score on the stem of the middle flower is the weakest point. Be very careful when folding it!

■ RED=cut halfway through ■ BLUE=score ■ BLACK=cut through

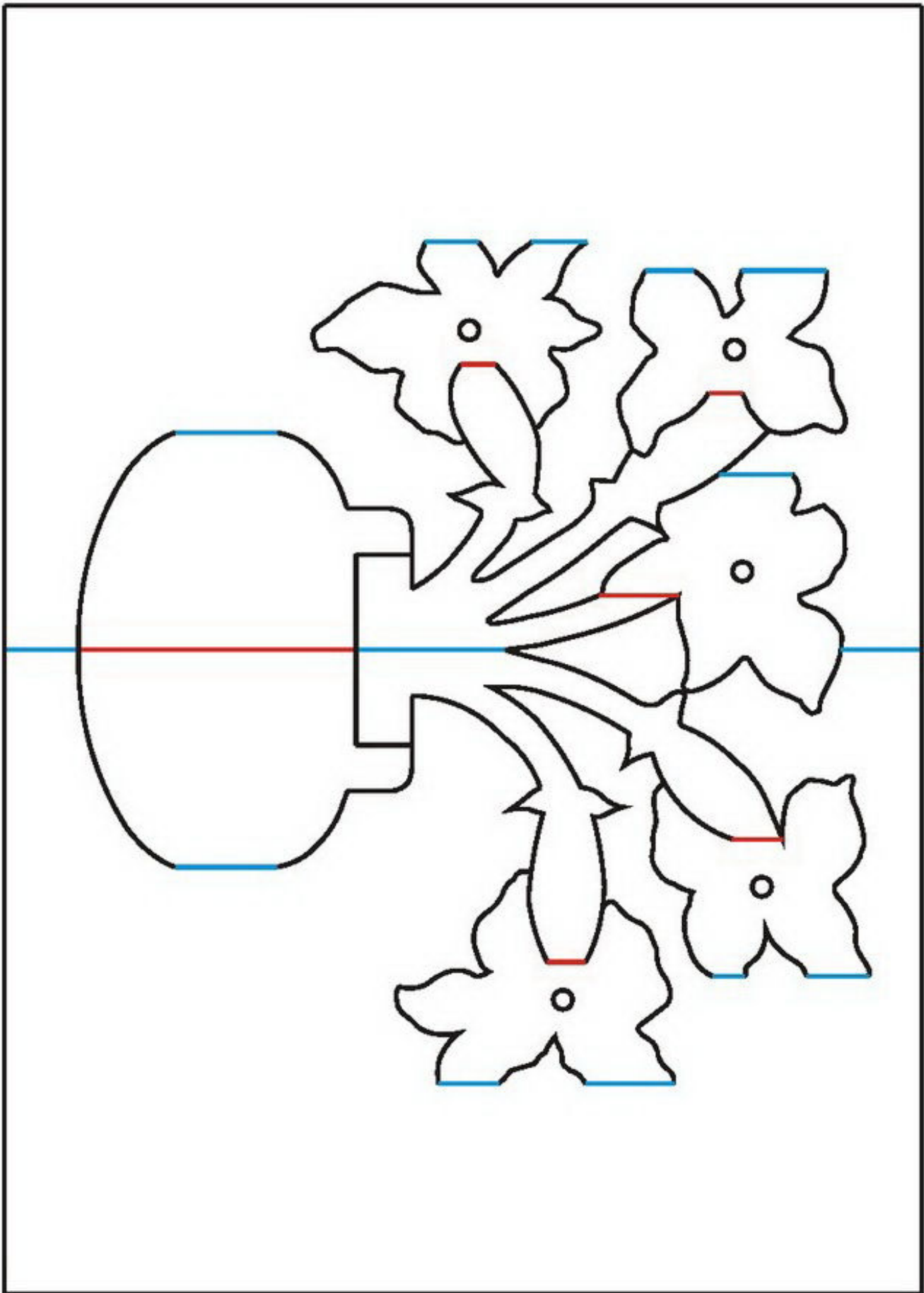



# Hot Air Balloon

DIFFICULTY  
LEVEL



## tips&tricks

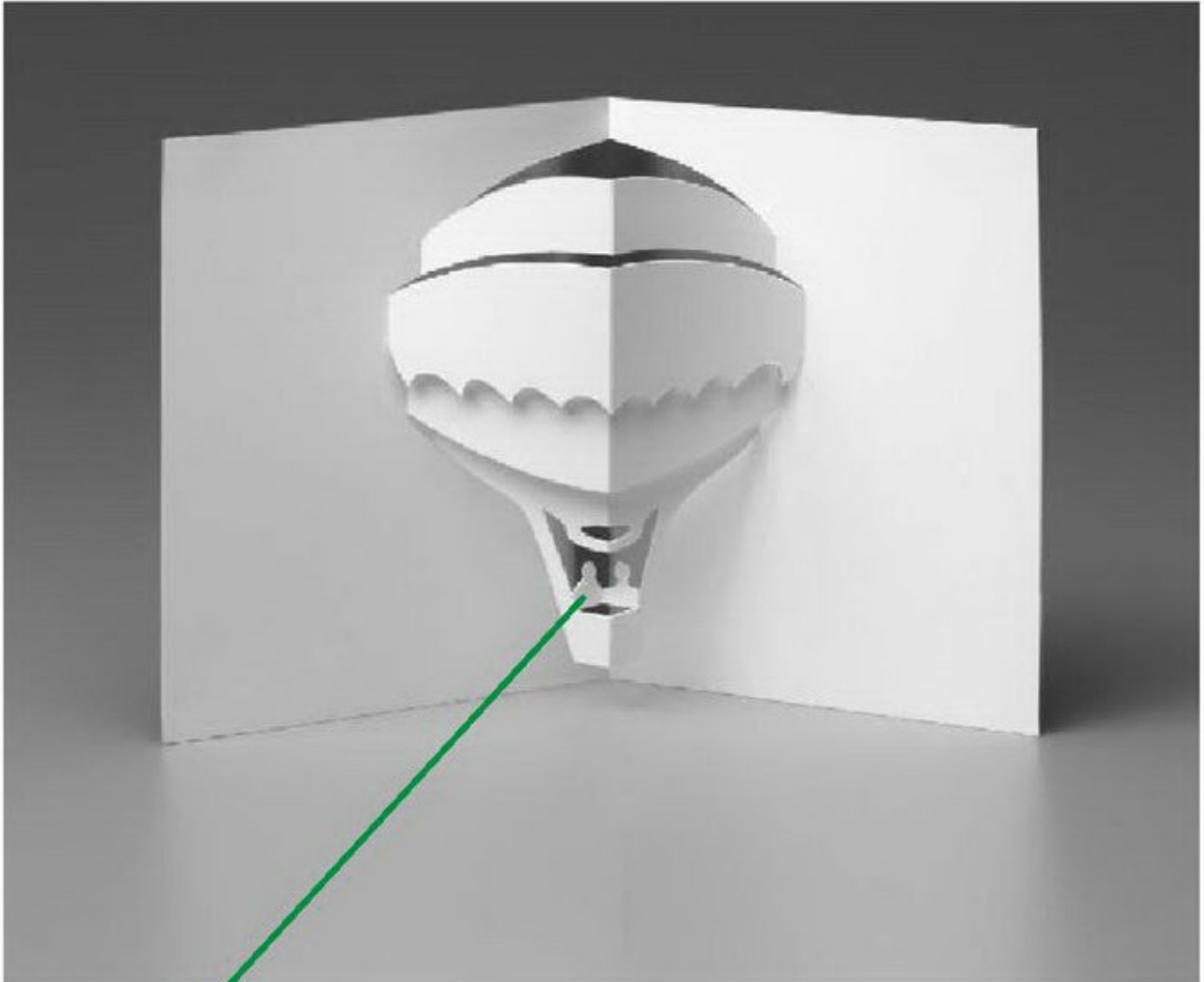

Make the people as detailed as you dare! The fun part of this design is the illusion of roundness.

■ RED=cut halfway through ■ BLUE=score ■ BLACK=cut through

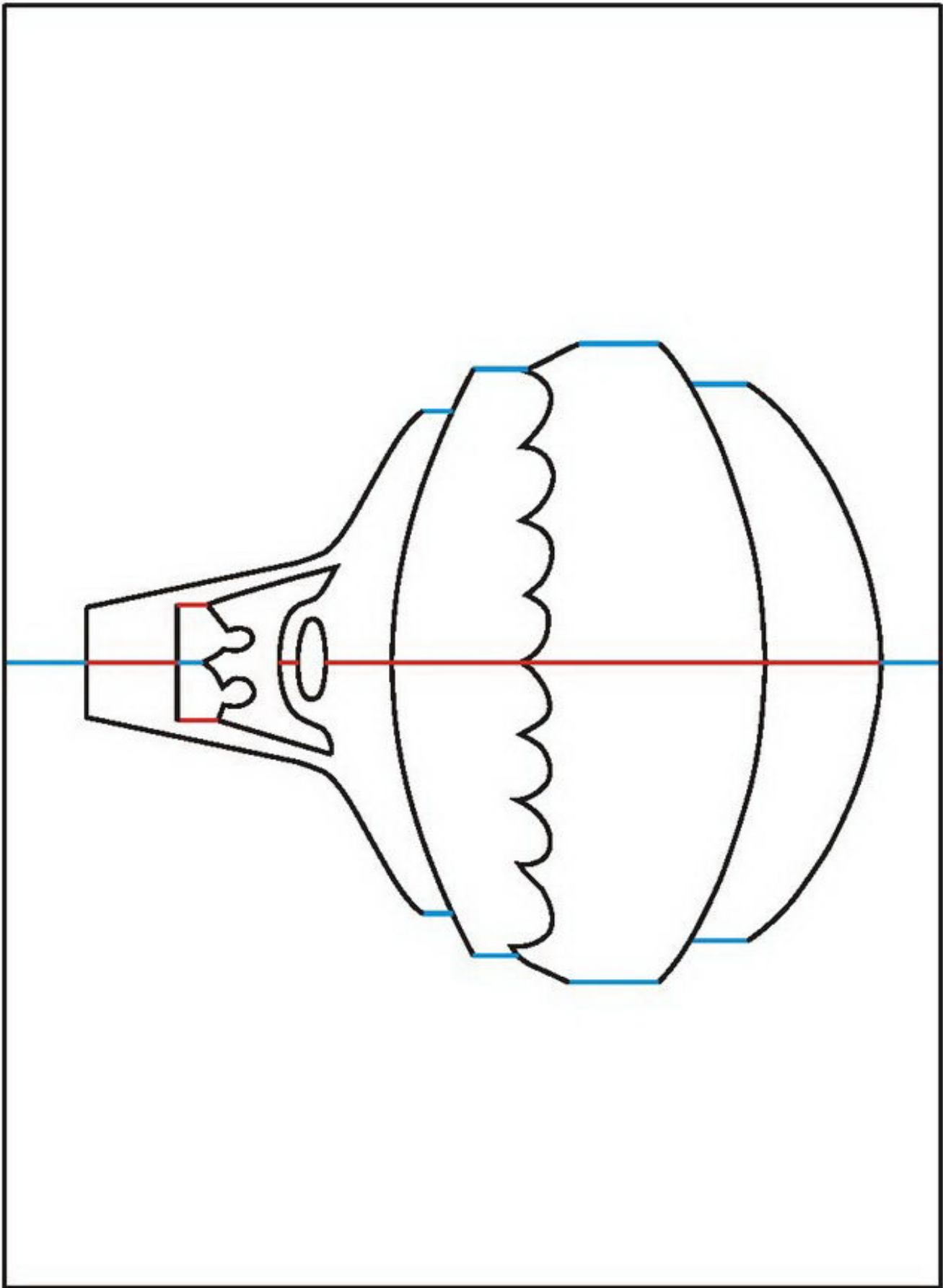

# Single Stem Rose

DIFFICULTY  
LEVEL



tips&tricks

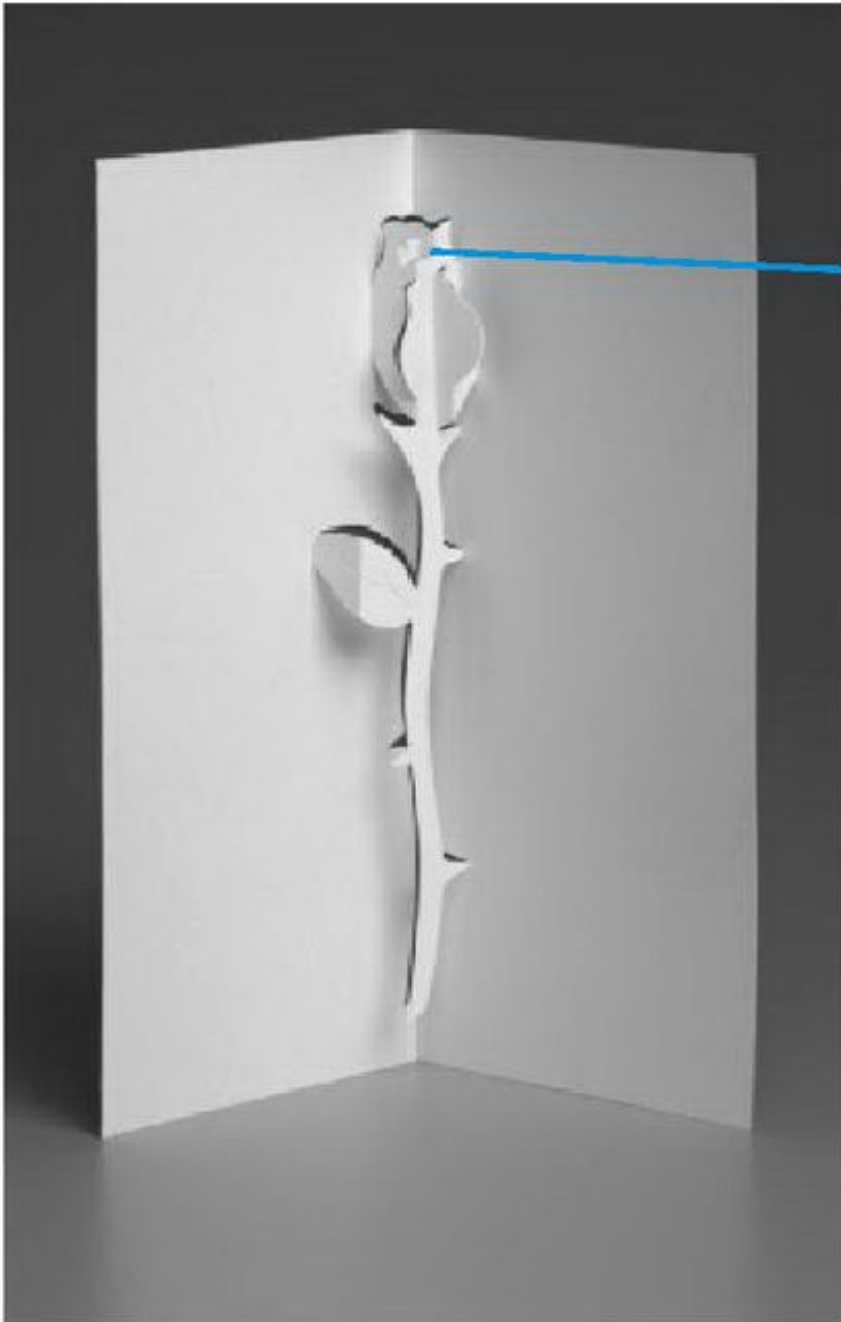

Push this part in with a toothpick or burnisher.

■ RED=cut halfway through ■ BLUE=score ■ BLACK=cut through

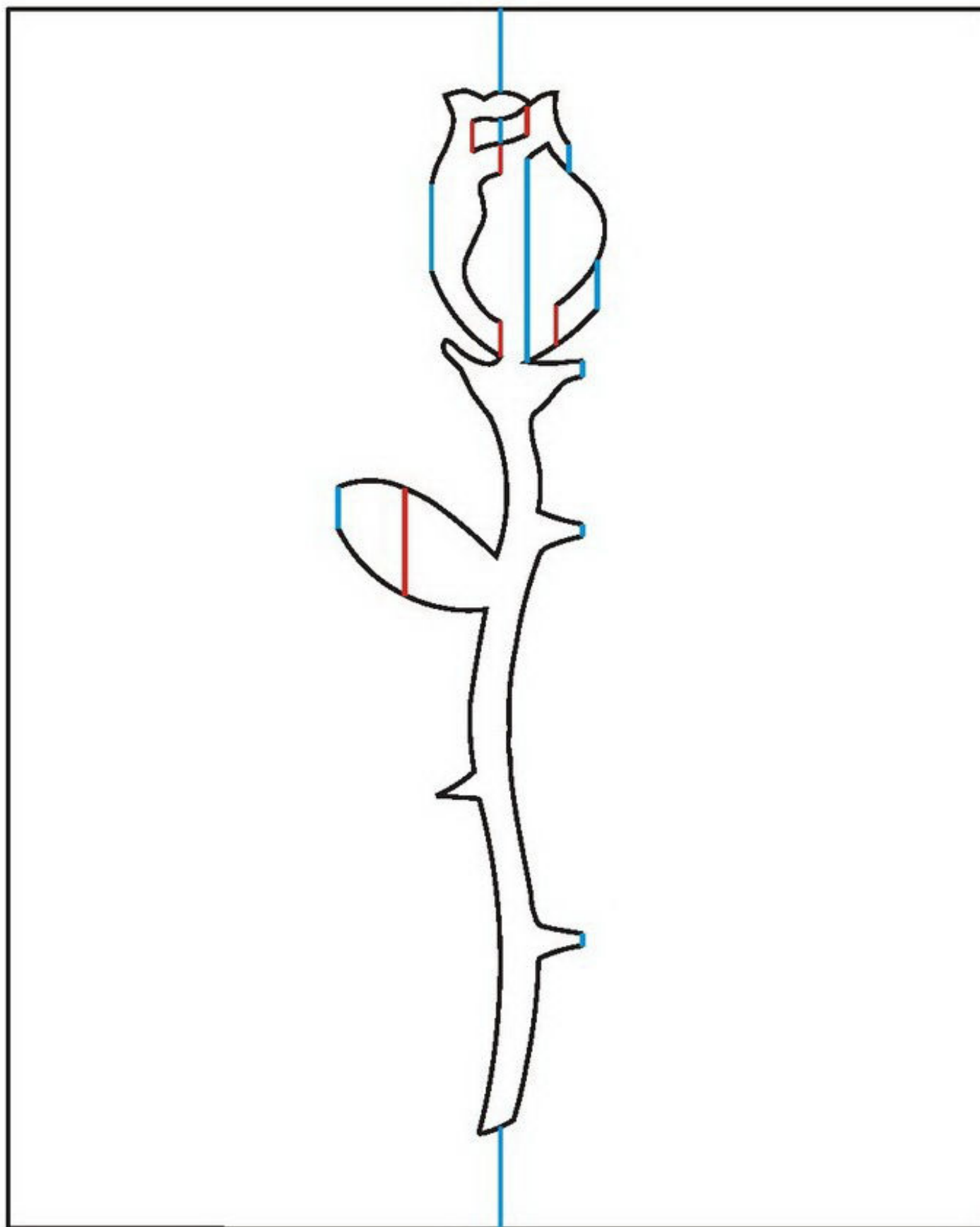

# Final Word

---

**Pop-ups are great for parties!**

**Here are some tips on making your own:**



1. Start with simple shapes. All complex shapes are made up from multiple simple shapes.
2. Make many sketches of the card before you start to cut
3. Avoid having a “tab” simply come out from the card to hold up your figure. Much of the satisfaction of good design follows by having nothing inherently “mechanical” about the mechanism that pops the card up.
4. Make a prototype, then set it down overnight. Come back to your work fresh and imagine the corrections and changes in three dimensions.
5. Be persistent! Anything can be made to pop-up!
6. Use grid paper to make your final patterns.