

종이접기 매니아를 위한

종이접기 스킬업

ORIGAMI SKILL UP
ADVANCED LEVEL

세계적으로 인정받는
한국 대표 종이접기 작가들의
다양한 작품을 통해 놀라운 세계를 경험해보세요

 **한국종이접기협회**
KOREA ORIGAMI ASSOCIATION

김진우 | 박종우 | 장용익 | 이인섭 | 맹형규 | 정재일 | 한지우 | 유태용

문화예술교육의 리더 (사) 한국종이접기협회

우리나라의 전통 종이접기, 종이문화를 계승하여 종이조형예술로서
진전한 생활문화로 발전시키고자 1989년도에 설립되었으며, 2000년
문화의 날에는 그동안의 문화예술 진흥발전에 기여한 공적으로 제
32회 「대한민국 문화예술상」 대통령상을 수상하였다. 2006년에는
국가에서 인증하는 국가공인 「종이접기 마스터」 자격 시행기관
으로 지정되어 문화예술교육의 선두주자로 인정받고 있다.

(사) 한국종이접기협회 활동

- 협회보 「종이문화」 발행
- 부설 한국종이문화원(종이조형 전문 연구기관)

종이접기, 색지공예, 한지그림, 디퓨지조형, 지호·지송공예, 종이조각,
종이장식, 비즈아트, 리본아트, 생활모장, 디퓨지조형, 종이접기, 종이
일러스트, 북아트, 어린이북아트, 스크랩북킹, 플레이머트, 플레이루키
아트, 냅킨아트, 선물포장아트, 한지인사아트 자격과정 운영

- 부설 종이조형 평생교육원 강좌 운영
- 종이접기·종이문화 전시회 및 세미나 개최
- 국제교류 코리아 종이접기 컨벤션 개최
- 공모전 개최

자격증 제도

- 국가공인 「종이접기 마스터」 지정 기관
- 종이접기·종이문화 민간 자격과정 지도자 양성 제도

회원등록 안내

- 회원등록 시 본 협회 행사 참여 및 활동에 대한 혜택이 주어지며
협회보 「종이문화」가 발송됩니다.



사단
법인 **한국종이접기협회**
KOREA ORIGAMI ASSOCIATION

문의 (사)한국종이접기협회 02-2264-4561 / www.origami.or.kr

종이접기 매니아를 위한

종이접기 스킬업

ORIGAMI SKILL UP

ADVANCED LEVEL

CONTENTS

◆ **FOREWORD** / 출간사 / P.3

◆ **ABOUT THE ORIGAMIST** / 작가소개 / P.4

◆ **MODEL INSTRUCTIONS** / 작품소개 / P.8

◆ **SYMBOLS OF FOLDING** / 종이접기 기호와 약속 / P.28

◆ **DIAGRAM** / 작품 도면



나방파리
P.30



나비
P.32



소드
P.37



침묵
P.41



마이코
P.47



아이스크림
P.54



수박조각
P.58



버니
P.65



토끼
P.71



피라루크
P.75



빨간통돔
P.83



아프간하운드
P.91



디모르포돈
P.97



다이노소어
P.102



태드래곤
P.110



흑등고래
P.120



포크레인 2
P.129



맹꽁이
P.138



청설모
P.146



알로사우루스
P.162

◆ **CREASE PATTEN** / 작품 전개도 / P.179

FOREWORD

출간사

1989년 창립 이래 30여년 동안 한국종이접기의 발전을 위해 활발한 활동을 펼치고 있는 사단법인 한국종이접기협회에서 <Origami Pro> 시리즈의 콤플렉스 종이접기에 대한 징검다리라 되어 줄 청작종이접기 매니아를 위한 입문서 <종이접기 스킬업>을 출간하게 되었습니다. 세계적인 작가로 발돋움한 한국의 대표적인 종이접기작가 여덟분의 개성이 담긴 20점의 작품들이 수록된 <종이접기 스킬업>은 한 장의 종이로 만들어지는 다양한 조형의 세계를 보다 친숙하고 디자인적으로 아름답게 표현하고자 한 점이 돋보입니다.

종이접기의 장점으로 익히 알고 있는, 한장의 종이로 남녀노소 누구나 장소에 구애받지 않고 즐길 수 있다는 점이 종이접기의 매력이며, 기술적인 공간작업을 이해하고 완성해 내는 능력이 나만의 성취감으로 느껴질 때 우리는 종이접기 전문가의 길로 가고 있다고 생각합니다. 고난이도의 작품들을 보고 어려움을 느끼셨던 많은 종이접기 매니아 분들은 이 책을 통해 좀 더 기술적인 접기능력의 향상으로 원하는 작품을 완성할 수 있는 능력을 기르시게 될 것입니다.

비쁘신 가운데 출간을 위해 애써주신 참여작가님들께 감사드리며, 이 책에 수록된 매력적인 작품들을 한 작품 한 작품 완성하면서 어느덧 종이접기 전문가가 되어있을 여러분께 대한민국 문화예술상 수상단체로서 종이문화보급에 앞장서고 있는 한국종이접기협회가 늘 함께 하겠습니다.

오경해

(사) 한국종이접기협회 회장

들어가는 말

올해초부터 코로나19가 대유행을 하게 되면서 전세계의 모든 활동이 멈추게 되었습니다. 매년 미국, 일본, 프랑스 등에서 실시하던 오리가미컨벤션도 예외는 아니었습니다. 한국 또한 2020년 코리아컨벤션이 취소되면서 매년 컨벤션에서 발표했던 오리가미프로시리즈의 발매가 연기되었고 오프라인으로 진행하던 많은 종이접기 수업들도 하지 못하게 되었습니다. 이러한 상황들은 한국종이접기창작가들의 작품활동과 종이접기를 좋아하는 애호가들에게도 좋지 않은 영향을 주었습니다.

그러므로 현상황을 좀 더 슬기롭게 이겨나가기 위해 한국종이접기협회와 작가들은 의견을 주고 받았으며 모든 연령대에게 사랑받을 수 있는 종이접기스킬업책을 세상에 내놓게 되었습니다. 이번책은 오리가미프로시리즈와는 다른 방향을 추구하기 위해 기발표작품과 미발표작품을 믹스하고 모든 작품들은 전문스튜디오에서 심혈을 기울여 촬영되었습니다.

난이도는 초급부터 고급까지 다양하게 구성하면서 작품의 선별과정과 사용된 종이 등 모든 부분에서 부족함이 없도록 최선을 다하였습니다. 아무쪼록 종이접기스킬업책이 침체된 한국의 종이접기활동에 동기부여가 되고 코로나로 힘든 시기를 보내고 있는 세계의 종이접기애호가들에게 큰 힘이 되기를 기대해 봅니다.

김진우

(사) 한국종이접기협회 창작위원

작가소개

ABOUT THE ORIGAMIST



1979 | 5669hsig@naver.com

김진우 *Kim Jin Woo*

초등학교 3학년 무렵부터 시작했던 종이접기가 이제는 제 인생의 큰 부분을 차지하는 목표가 되었습니다. 올해로 회사생활 근속 18년을 맞이하면서 지나온 날들을 뒤돌아 보게 됩니다. 살아왔던 모든 순간과 변화하는 일상속에서 종이접가를 잊어본 적이 없습니다. 그렇기에 앞으로 이어질 종이접가책 제작의 작업은 제 인생의 나아가야 할 방향을 제시해 주는 것 같습니다. 흔히 종이접기라고 하면 조용한 공간속에서 혼자만이 즐길 수 있는 소극적인 취미생활로 생각할 수 있었지만 종이접가야말로 타인과 소통할 수 있는 최고의 활동이라고 할 수 있습니다. 특히 요즘은 누구나 쉽게 종이접기에 대한 많은 정보를 얻고 교류를 할 수 있는 시대입니다. 이번 종이접기스킬업책을 통해 종이접기에 관심이 있는 우리 아이들 및 모든 연령층이 즐거운 시간을 가질 수 있다면 저뿐만 아니라 저희 작가들 또한 큰 보람을 얻을 것입니다.



1989 | woodfd0@naver.com

박종우 *Park Jong Woo*

현재 항공사 승무원으로 재직 중이며 다양한 곳에서 보고 느끼는 것들을 바탕으로 작품 활동을 이어나가고 있습니다. 주로 22.5도 선을 활용하여 중간 난이도 이상의 작품들을 창작해왔으나 이번 책에서는 약간 힘을 빼고 종이접기의 원초적인 즐거움을 느낄 수 있는 작품들을 수록했습니다. 디테일을 더하는 것은 쉬우나 빼는 것은 무척이나 어려운 일입니다. 그만큼 대상의 특징을 정확하게 파악하고 있어야 하기 때문입니다. 그런 의미에서 봤을 때 이번에 수록한 작품들은 향후 제가 지향해야 할 방향성을 제시해주는 그런 작품들인지도 모르겠습니다.

2020년 한 해는 전례 없는 전염병으로 인해 모두에게 힘든 시기였습니다. 종이접기 업계 역시 예외일 수는 없었으며 저희 오리гами 프로 팀도 큰 난항을 겪었지만 위기를 기회로 만들어 보자는 일념 하에 모두가 의기투합하여 이번 오리гами 프로 라이트를 출간하게 되었습니다. 비교적 부담없이 접근할 수 있는 작품들인 만큼 더 다양한 사람들이 즐길 수 있으리라 생각합니다. 많은 행사가 취소되고 도서의 출간도 뒤로 밀리면서 새로운 작품집에 목 말라있을 많은 분들께 가뭄의 단비 같은 책이 되길 기원합니다.



1991 | yklong_21@navor.com

장용익 *Jang Yong Ik*

그래픽 디자이너로 근무중이며 종이접기 창작 및 강의 활동과 함께 매년 오리가미프로 시리즈를 기획/편집을 담당하고 있습니다. 동물, 곤충, 사물, 음식 등 주제의 제한 없이 넓은 스펙트럼의 주제로 창작을 하고 있습니다. 난이도 또한 심플계열에서 슈퍼콤플렉스계열까지 창작목적과 표현하고자하는 느낌에 유리하게 설정하여 작업하고 있습니다. 한장으로 접어내야 하는 종이접기의 한계적인 부분의 해결을 위해 비교적 큰 사이즈의 종이로 접어내는 동시에 구성에 대한 밀도나 전체적인 프로포션이 뒷받침 되도록 주로 사용하는 종이인 한지가 작품에 적합한 텍스처를 가질수 있도록 염색기법의 개발을 통해 다양한 시도를 하고 있습니다. 서른살의 마지막을 뜻 깊은 작품집으로 마무리하게되어 영광이라 생각하며 앞으로도 즐겁고 행복한 종이접기를 접하실 수 있도록 많은 활동을 이어나가겠습니다.



1992 | inseop999@naver.com

이인섭 *Lee In Seop*

유치원 때 시작했던 종이접기를 접던 어떤 사람이 어느 새 직장인이 되었습니다. 세월이 쌓이는 동안 나만의 작품과 캐릭터가 충분히 잡혔다고 생각합니다. 작품 스타일이 난해하고 난이도도 대체로 높은 쪽에 속하는지라 이번 프로 라이트는 또 다른 도전이었습니다. 이번 수록은 구작 1, 신작 1로 구성하였습니다. 둘 다 종이접기에서는 찾아보기 힘든 주제로 흥미롭게 접어주셨으면 좋겠습니다. 워낙 독특한 걸 많이 접는지라 출판을 거절당하는 경우가 많았었습니다. 이번 프로 라이트에 참여하게 되어 영광으로 생각합니다.



맹형규 *Maeng Hyeong Kyu*

안녕하세요 맹형규입니다. 저는 작품을 창작 할 때 사실적으로 표현하는 것을 추구합니다. 때문에 저의 작품 대부분은 세심한 디테일까지 표현되어 있습니다. 하지만 프라이트를 준비하며 특징은 살리되 너무 어렵지 않고 디테일의 생략을 통해 더욱 가볍게 접을 수 있게끔 창작을 하였습니다. 초보자분들에게는 수준 높은 종이접기에 한 걸음 더 나아갈 수 있도록, 숙련자분들에게는 어려운 작품을 접으며 피로했던 몸과 마음을 달래주는 책이 되기를 희망합니다.

1993 | mmmhg@naver.com



정재일 *Jeong Jae Il*

정사각형 종이 한장의 선과 면으로 대상을 표현하는, 수학적이고 기술적인 재미에 매료되어 창작 활동을 하고 있습니다. 정사각형의 한 모서리를 4등분한, 22.5도 기반의 정형화된 작품을 추구합니다. 프로젝트로 진행되는 출판용 작품은 주제선정과 작품, 도면의 퀄리티까지 기간 안에 모두 만족시켜야 하기 때문에, 스스로의 만족으로 창작을 할 때보다 큰 부담감을 안고 진행됩니다. 이런 새로운 자극이 매년 조금 더 나아질 수 있는 원동력이 되고 있습니다. 어린시절 공룡접기 책에 빠져 종이접기를 시작했던 저처럼, '오리가미 프로'를 통해 많은 분들이 종이접기의 매력에 빠져보시길 기대합니다.

1993 | wjdwod1009@gmail.com



1995 | nuju852@naver.com

한 지 우 *Han Ji Woo*

14살에 우연히 접한 종이접기를 10년이 넘는 지금까지도 놓지않고 계속 하고 있습니다. 적은 시간이 아님에도 불구하고 계속 흥미를 접을 수 있었던건 즐기기 때문이 아닐까라고 생각합니다. 누가 시키지 않았지만 재밌어서 혼자서 흥미를 접고, 더 많은 정보를 위해 온라인에서 사람들과 소통하고, 친해진 사람들과 오프라인에서 직접 만나기도 하며 지금까지 즐겨왔던것 같습니다. 창작 프로세스가 완벽하게 정립되지 않았지만 참여작가분들의 도움으로 올해도 멋진 작품을 실을 수 있게 되었습니다. 제가 작품을 만드는데 있어서 가장 중요하게 생각하는것은 '작가 본인의 색' 입니다. 같은 주제의 작품을 만들더라도 작가마다 표현 방법이 다르기 때문에 남들과는 구분이 되는 본인 만의 색을 가지고 있어야 한다는 것입니다. 그 때문에 앞으로의 목표도 저만의 색이 묻어나는 작품을 창작하는 것입니다. 운이 좋게도 프로젝트 5권에 합류하였고 벌써 2번째 참여입니다. 이번책에 실린 작품은 나비와 맹공이입니다. 누구나 알고 있을만한 흔한 주제와 아직까지 세상에 공개된 적이 없는 주제를 택했고, 이번 책에 실린 다른 작품들도 그런 식의 주제들이 많습니다. 가볍게 즐길 수 있는 작품 부터 스킬이 필요한 작품 까지 다양하고 멋진 책의 작품들 즐겨보시면 좋겠습니다.



1996 | qpemth95@naver.com

유 태 용 *Yoo Tae Yong*

현재 시각디자인과 졸업을 앞두고 곧 사회에 첫발을 내디딜 준비를 하고 있습니다. 주로 22.5도 계열의 창작을 선호하며 주로 한생동물을 위주로 창작을 하고 있습니다. 제가 추구하는 종이접기에서의 표현 방법은 '단순화'입니다. 종이접기 창작을 갓 시작한 분들의 작품을 보면, 되도록 복잡하고 많이 표현하려고 노력한 흔적이 보입니다. 하지만 표현적인 부분보다 조형적인 부분을 좀 더 고민하고, 작품 전체의 실루엣에 초점을 맞추고 창작을 한다면 보다 더 종이접기 본연의 즐거움을 느낄 수 있는 작품이 탄생한다고 생각합니다. 그러나 최근 ORIGAMI PRO에 수록된 저의 작품들을 되돌아보면, 난이도가 점점 어려워지고 표현 또한 복잡해지고 있다는 의견이 다수 존재했습니다. 그것이 나쁘다고 생각하지는 않지만 앞으로 작품을 창작할 때 제가 추구하는 종이접기의 색을 잃어버리지 않게 더 노력해야겠다는 생각이 듭니다. 이번 책에서는 제가 위에서 말씀드린 추구하는 바가 어떤 것인지 느낄 수 있으리라 생각합니다.



나방파리

Moth fly

화장실에서 흔하게 볼 수 있는 '날파리'라고 불리는 곤충입니다. 이 곤충의 정확한 이름은 나방파리입니다. 하수구나 오물이 많은 지역에서 서식하기 때문에 오염지표로 이용되기도 합니다. 성충은 회갈색의 온몸에 털이 있습니다. 애벌레는 다리가 없는 흰색의 지렁이 같은 모습이며 미끈미끈한 하수도에 서식합니다. 이러한 습성 때문에 이 곤충의 영어이름은 하수도 파리 'Drain fly'입니다. 사워기로 잡으려 하지만 절대 잡히지 않는 강인함을 보이기도 하는 곤충입니다. 삼각주머니로 간단하게 접히며 더듬이와 하트모양의 날개를 표현하였습니다. 또한 밑 부분의 깎이는 부분은 더욱 생동감 있는 연출을 가능하게 합니다. 작은 종이로 접으면 매우 사실적입니다.



나비

Butterfly

박스플릿으로 비교적 간단하지만 완성도는 높은 그런 작품을 창작하고 싶었습니다. 생물에서 곤충, 곤충에서 나비로 주제가 정해지고 설계에 들어갔습니다. 여러 등분을 시도해본 결과 16등분이면 적합하겠다고 생각했습니다. 그리 높은 등분이 아니면서 분할하기 쉽기 때문 입니다. 단순한 구조지만 나비의 특징은 살리며 세부 디테일은 과감히 포기하였습니다. 박스플릿 특유의 주름 떨치기와 색반전을 활용합니다. 색반전이 꽤나 크게 들어갑니다. 종이가 찢어지지 않도록 조심해서 진행해야 하겠습니다. 배부분은 종이의 중앙 가지로 표현되어 상당한 종이겹침이 발생합니다. 얇고 튼튼하면서 양면의 색이 다른 종이를 추천드립니다. 접는분에 따라 각 날개의 모양을 다르게 표현해보는것도 좋겠습니다.

소드

Sword

크기 효율이 좋은 작품입니다. 흔히 구할 수 있는 정도의 사이즈 종이를 사용해도 실제 칼만한 크기를 구현할 수 있습니다. 가운데 다이아몬드 무늬 부분이 가장 어렵고 두껍습니다. 설계상 스스로 고정되기 어려운 형태로 꼭 풀로 접착하여 마감하기를 권합니다. 모양을 스스로 지탱할 수 있도록 은박지(칼날을 표현할 수 있는 것은 범입니다.)나 몸체에 단단한 재료를 끼우는 것을 추천합니다.



침묵

Silence

창작하게 된 계기가 독특합니다. 회사 부장님이 이것저것 추상적인 주제를 던지시며 접을 수 있는지 물어본 적이 있습니다. 그 중 "침묵"이라는 주제가 마음에 남아 접고 싶어졌습니다. 단어를 듣고 연상된 이미지는 손가락을 입술에 대고 쉿 하는 모습이었습니다. 간단히 입술과 손만 표현하였고 구조는 계획도 하지 않고 단 한 번에 나왔습니다. 시행착오도 없어 원하던 모습을 단번에 구현한 작품은 처음입니다. 작품명은 침묵이지만 동료 작가들은 쉿, 가운데 손가락 등이 연상된다는 평가를 해주었습니다. 다른 부분은 다듬기라고 부를 부분이 필요 없지만 손은 손가락, 마디, 손톱 등이 표현되며 약간의 입체 형상이라 어려울 수 있습니다. 손의 특성상 풀을 바르기 어려운 부분이 있어서 종이 자체가 형상을 유지할 수 있도록 단단하거나 은박지가 포함된 종이 좋았습니다.



마이코 MAIKO

마이코는 제가 일본 유학 당시, 일본의 에도시대를 경험할 수 있는 '닛코 에도무라'에 갔을 때 본 마이코를 보고 창작한 작품입니다. 마이코가 처분하게 서 있는 모습과 예쁜 기모노가 너무 인상
에 남아 그 모습을 그대로 표현하고 싶었습니다. 기본형은 착점기 기본형을 사용했으며 다소 함
몰접기가 많은 작품이라서 구겨지지 않게 접는 것이 포인트라고 생각합니다. 아쉬운 점이 있다면
얼굴이 종이 내부에서 만들어지기 때문에 색반전이 안된다는 점이 많이 아쉽습니다. 종이 크기는
25cm 정도가 적당하며 가능하면 꽃이나 패턴 무늬가 있는 종이로 접는 것을 추천해 드립니다.

아이스크림

Icecream

평면으로 표현한 아이스크림입니다. 간단하지만 비대칭 구조를 사용해 접어가면서 색다른 재미를 느낄 수 있습니다. 다듬기없이 완성된 모습에서 종이접기스러움을 느낄 수 있는 작품으로, 단순한 외형에 비해 선을 내는 과정이 많지만 이후에 차곡차곡 접혀가는 재미가 있습니다. 과자의 와플무늬를 접었다 편 선으로 표현했는데, 와플의 볼록한 느낌을 표현할 수 있도록 너무 얇지 않은 종이를 꼭꼭 눌러서 접어주시면 좋으며, 너무 크지 않은 종이를 접는것이 작품의 느낌을 잘 살릴 수 있습니다.



수박조각

Watermelon Piece

2017년 한국종이접기협회의 여름호 계간지에 수록된 적이 있는 작품입니다. 접는 난이도는 매우 간단하지만 입체의 모양으로 완성하는 특이한 과정도 있기 때문에 종이접기스킬업에 수록하게 되었습니다. 물론 다이어그램은 이전보다 자세히 다시 그렸으니 예전에 접어보신 분들도 한번 더 도전해 보시기를 추천드립니다. 수박조각을 처음 창작했을 때는 적당한 양면종이가 없어 색종이를 사용하였지만 2019 프랑스로움컨벤션에서 특별한 종이를 구하게 되어 이번 종이접기스킬업의 멋진 작품으로 재탄생할 수 있었습니다. 완성 후 수박조각은 작은 접시에 담고 수박씨와 작은 칼을 소품으로 집어서 함께 구성하면 멋진 장면이 연출될 것입니다.



버니

Bunny

애니메이션 주토피아의 주디홉스라는 캐릭터에 큰 매력을 느껴서 창작한 작품입니다. 모티브가 된 캐릭터는 여자였지만 저는 표현의 용이성을 위해 좀 더 중성적인 느낌으로 만들었습니다. 주로 색반전을 활용하여 표정을 표현한 만큼 자칫 잘못 접게 되면 인상이 달라질 수 있습니다. 다이어그램에 표시된 수치들을 정확히 지켜주시기 바랍니다. 전개도를 통해 색반전이 되는 포인트들을 미리 파악하여 다양한 색으로 부분합지를 한다면 더욱 리얼한 표현도 가능합니다. 만드는 과정은 비교적 간단하나 완성 후 종이층들이 고정되는 부분들이 없기 때문에 오랫동안 원형을 유지하고 싶으신 분들은 풀로 고정하는 것을 추천 드립니다.



토끼

RABBIT

이 작품은 원래 제가 한국에서 '대문 종이접기'라는 종이접기 책을 기획하다가 나온 첫 번째 작품입니다. 아쉽게도 프로젝트는 잠시 중단되었지만, 대문 접기에서도 다양한 작품들이 파생될 수 있다는 것을 알리고 싶었습니다. 예전에도 한번 토끼를 창작한 적이 있는데, 그 토끼는 앉아서 있는 자세를 표현했습니다. 그래서 이번에 창작할 때는 서 있는 자세를 만들어보면 어떨까 생각이 들었습니다. '코마츠 히데오' 작가의 '토끼' 작품을 많이 참고했으며 되도록이면 표현보다는 실루엣 쪽에 더 초점을 맞추어 창작한 작품입니다. 종이 크기는 20cm가 적당하며 되도록이면 두꺼운 종이를 사용하는 것을 추천해 드립니다.



피라루크

Pirarucu

가장 거대한 민물고기라는 타이틀을 가지고 있는 매력적인 주제입니다. 흡사 용을 연상케 하는 자태에 가슴이 웅장해져서 창작했습니다. 물고기 창작은 이 작품이 처음이었음에도 불구하고 긴 가지들을 뽑아낼 필요가 없어서인지 생각보다 수월하게 진행 할 수 있었습니다. 오히려 22.5도 선을 활용하여 지느러미를 만드는 과정이 상당히 재미있었던 기억이 남습니다. 구조상 크게 두꺼워지는 부분은 없으나 접어봤을 때 평량이 높지 않은 종이 작품에 더 어울리는 느낌이 들었습니다. 문구점 등에서 쉽게 구할 수 있는 색한지 정도면 충분할 것 같습니다. 실제 모습보다 많이 각진 느낌이 들 수 있기 때문에 마무리 과정에서 자연스러운 곡선을 만들어 주는 것이 중요한 포인트입니다.



빨간통돔

Red snapper

빨간통돔으로 알려져 있는 이 물고기는 실제로 풍미가 굉장히 좋아 각종 요리에 사용되는 물고기입니다. 통돔의 종류는 어마어마하게 많은데 대부분 따뜻한 열대의 바다에서 작은 물고기, 갑각류 등을 먹고 살아갑니다. 전형적인 유선형인 몸의 형태와 강인한 얼굴이 특징입니다. 깔끔하고 최대의 효율을 위해 노력을 많이 기울인 작품입니다. 간단한 표현만으로 물고기의 디테일한 특징을 살펴보았습니다. 30cm의 종이크기가 적당하며 비오름과 같이 선이 잘 보이는 종이를 사용하면 좋습니다. 완성 후에 휴지 같은 완충재를 넣어주면 볼륨감 있는 생선을 표현 할 수 있습니다.

아프간하운드

Afghanhound

길고 우아한 털이 매력적인 아프간하운드입니다. 가장 큰 특징인 긴 털을 표현하는데 중점을 두고 창작한 작품으로, 귀와 몸의 털 이외부분은 최소한의 표현으로 남겨두었습니다. 귀족이라는 별명에 걸맞게 고개는 살짝 치켜든듯한 도도한 실루엣을 표현했습니다. 다리를 생략하고 털로 단 순히 표현해 접는 과정에서 특별히 난이도나 높은 부분은 없지만, 몸 부분의 종이가 단 두겹으로 힘없는 종어로 접으면 모양을 잡기 어렵습니다. 색종이 정도의 힘이 있는 종어로 접는것을 추천드리며, 완성 후 곡선을 살려 다듬어주었을때 더욱 매력적인 작품입니다.



디모르포돈

Dimorphodon

개인적으로 좋아하는 작가인 마츠모토 카즈야의 작품 스타일에서 영감을 얻어 창작한 작품입니다. 일명 치비오리라고 불리는 시리즈로 굉장히 심플하지만 대상의 특징이 놀랍도록 잘 표현되어 있어서 저에게 깊은 인상을 주었습니다. 여기에 힘입어 저 역시 단순하게 표현하되 특징만은 정확히 캐치한다는 것을 중점적으로 생각하며 만들었습니다. 디모르포돈은 머리가 크고 특징이 뚜렷한 익룡으로 이런 식의 표현이 용이할 것 같아서 주제로 선택하게 되었습니다. 예비선도 필요가 없고 기본형도 학집기에서 출발하는만큼 누구나 부담없이 접을 수 있으리라 생각합니다. 훗날 여유가 된다면 저도 이런 식의 작품들로 시리즈를 만들어 보고 싶은 생각이 있습니다. 완성 후 디모르포돈의 실제 복원도와 한 번 비교해보시길 바랍니다.



다이노소어

Dinosaur

특별한 대상을 두지 않고 머리속에 떠오르는 공룡에 대한 이미지를 특징 기법에 기반하여 조형적인 디자인으로 완성한 공룡입니다. 우측의 작품사진 촬영시 어린이 방에 하나쯤 있을 법한 공룡 장난감의 느낌을 담고자 침대의 의자를 활용한 구도를 사용하였습니다. 공룡의 등 부분에 돌기와 눈 부분에 색반전 기법이 적용되어 있으니 양면이 다른 색상을 사용하는 것을 권장하며 돌기의 색과 몸체의 색상이 어울리는 조합을 사용하시기를 추천드립니다. 실제적으로 종이의 배본이 고르게 되어있어 쉽게 자립시킬수 있으나 기법상 등 부분의 벌어짐이 있으니 고정력이 좋은 종이를 사용하시거나 약간의 풀칠로 마무리하시면 높은 완성도로 완성하실 수 있습니다.



래드래곤

TAE-DRAGON

용이라는 주제는 너무나도 인기가 많고, 그만큼 너무나도 멋진 작품들이 많이 존재하지만, 개인적으로 좋아하는 작품은 '카미야 사토시' 작가의 '메이선트 드래곤'입니다. 그 이유는 대부분의 용 작품을 보면 자세가 역동적이고 사나워 보이지만, 이 작품 같은 경우는 이름 뜻 그대로 앉아만 있어도 고대 용이라는 포스가 느껴지기 때문입니다. 제가 원하는 용의 이미지 또한 그러하기 때문에, '역동적인 용'이 아닌 '중후한 용'을 컨셉으로 잡고 창작에 들어갔습니다. 이 작품의 재밌는 부분을 꼽자면 꼬리를 한쪽으로 꺾어서 자립이 가능하다는 점입니다. 작명은 마땅한 이름이 떠오르지 않던 중, 제 이름을 이용하면 어떨까 싶어 태드래곤으로 지었습니다.



흑등고래

Humpback Whale

제주국제공항의 LED 고래 모형을 보고 영감을 얻어 창작한 작품입니다. 저의 향후 스타일에 대한 고찰을 많이 하던 시기에 만든 작품이라 그런지 나름대로의 변화를 많이 꾀했던 기억이 납니다. 모두가 쉽게 따라 접을 수 있고 또 완성 후의 모습이 원작과 크게 다르지 않은 그런 작품을 만들고 싶다고 생각했습니다. 아마도 앞으로 나올 작품들은 이런 느낌의 작품이 주를 이루게 될 것 같습니다. 기획 단계에서부터 너무 높지 않은 난이도로 가겠다고 결심했던 만큼 최대한 종이접기의 원초적인 즐거움을 느낄 수 있도록 설계했습니다. 접어보시면 퍼즐을 맞추는 듯한 느낌을 받을 수 있을 것입니다. 예비선을 내는 과정이 비교적 길긴 하지만 후반부의 재미를 위한 투자라고 생각해주시면 감사하겠습니다.



포크레인 ver.2

Poclain ver.2

2017년 오리가미프로 기계종이접기편에 수록된 포크레인의 버전.2 작품입니다. 그 당시 기계종이접기편의 포크레인은 창작 후 다이어그램을 그릴 시간이 부족하여 크리스패턴으로만 수록하였는데 의외로 인기가 있어 다음해에 일본절지탐정단 매거진에 다이어그램을 수록하였습니다. 저 또한 이 작품에 매우 애착을 많이 가지고 있으므로 이번에는 버킷의 방향을 안쪽으로 향하도록 하고 운전석을 좀 더 재미있는 방법으로 디자인하였으며 종이접기스킬업에 수록하기 위해 많은 부분을 다시 구상하였습니다. 종이는 운용지 2장을 합지하여 사용하면 묵직한 느낌의 포크레인을 완성할 수 있을 것입니다.



맹꽂이

Boreal digging frog

아무도 접지 않은 주제를 한 번 만들어 보고 싶었습니다. 우리나라 사람이라면 한번쯤은 들어봤을만한 생물 맹꽂이입니다. 짧은 다리와 뚱뚱한 몸통을 중점에 뒀습니다. 종이 중심에서 머리가 나오고 모서리 네 곳에서 다리가 뿐혀져 나옵니다. 박스 플릿이 아닌 작품 창작은 처음이라 22.5도의 늪에서 길을 찾지 못하고 결국 다리와 배부분의 연결 부분의 도면이 매끄럽지 못하게 되었습니다. 작품은 색반전이 들어가므로 양면의 다른색의 종이를 사용하는 것이 좋습니다. 종이 겹침이 전체적으로 많지는 않고, 완성시에도 무게감이 있어보이면 작품이 더 돋보이기에 너무 얇은 종이는 피하는 것이 좋겠습니다. 도면은 이인섭 작가의 도움을 받았습니다. 도면화하기 상당히 까다로운 부분이 많았음에도 불구하고 멋지게 완성해주셔서 감사하다는 말을 전합니다.



청설모

Korean squirrel

저의 마지막 예비군 훈련 중 산속에서 발견한 도토리나무 아이디어로 시작하여 창작하게된 청설모입니다. 청설모는 얼핏 보면 다람쥐와 비슷한 외형으로 종종 오해받기도 하지만 겨울에 털이 자라나게 되면 귀부위에 4~5cm의 겨울털이 자라면서 개성있는 모습이 됩니다. 이 특징과 함께 뽕뽕한 볼, 손가락과 발가락을 시원시원하게 마무리하여 종이접기다운 맛이 느껴질 수 있도록 접어 냈습니다. 다이어그램대로 작품을 접어내고 목을 살짝 꺾어주거나 꼬리의 곡선을 충분히 살려서 입체적으로 동세를 잡아주면 보다 생동감있는 모습이 되므로 작품의 마무리에도 공들여서 완성하시길 추천드립니다.



알로사우루스

Allosaurus

꼭 한번 멋지게 창작해보고 싶었던, 쥐라기의 최상위 포식자 알로사우루스입니다. 티라노사우루스와 대비되는 긴 앞발을 표현하기 위해 머리가 가운데서 나오는 재미있는 구조를 사용했습니다. 날카로운 이빨은 따로 표현되진 않았지만 몸과 머리의 실루엣으로 대상의 특징을 잘 표현할 수 있도록 고민했습니다. 중심에서 머리가 나오다보니 팔각싱크를 비롯한 다소 난이도있는 기법들을 활용하게 되었지만, 다음 스텝의 그림을 참고해서 접이기면 큰 어려움 없이 완성하실 수 있습니다. 색반전이 없고 상반신에 종이 두겹이 몰리는 경향이 있어 크고 얇은 한지를 사용해서 접는 것을 권장드리며, 완성 사진을 참고하셔서 동세를 잡아주시면 더욱 생동감있는 작품으로 완성하실 수 있습니다.

종이접기 기호와 약속

SYMBOLS OF FOLDING

A. 화살표 기호

글접기	산접기	접었다 펴치기	계단접기	펼치기
잡아당기기	회전하기	뒤집기	확대하기	함몰접기

B. 접기 선

글접기 선	산접기 선

C. 종이의 방향

회전하기	뒤집기

D. 보조기호

각도의 등분	길이의 등분	주의해야 할 곳	숨어있는 선	90도	보는 방향

E. 기본 접기

접기선 내기 ①

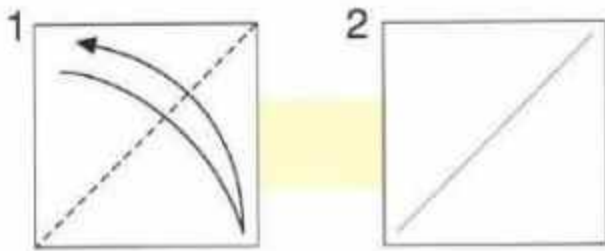

접기선 내기 ②

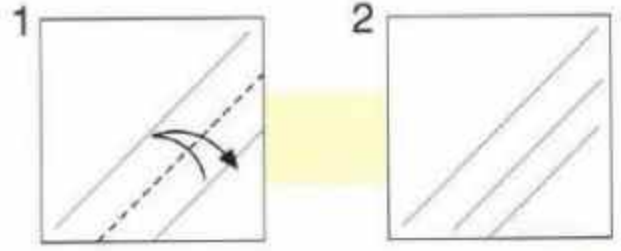

안쪽으로 접기

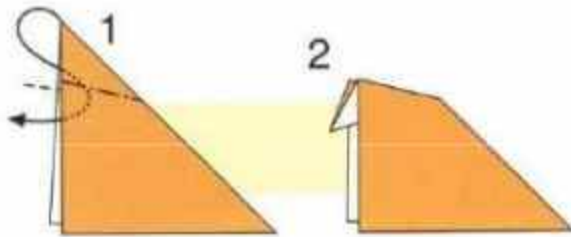

펼쳐 눌러접기

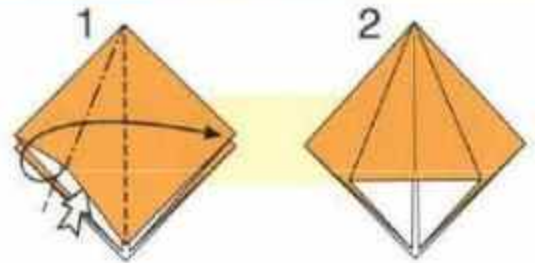

계단접기

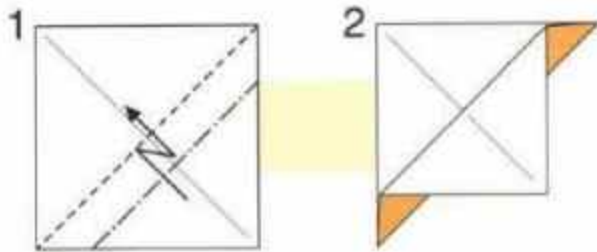

양쪽 계단접기

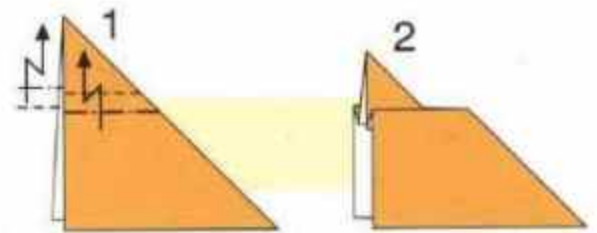

함몰접기

Open Sink

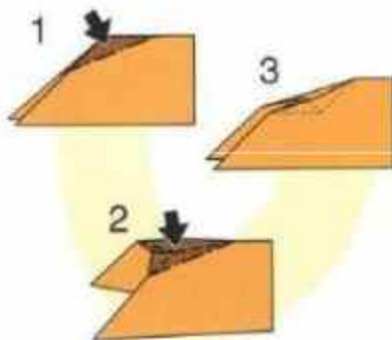

Closed Sink

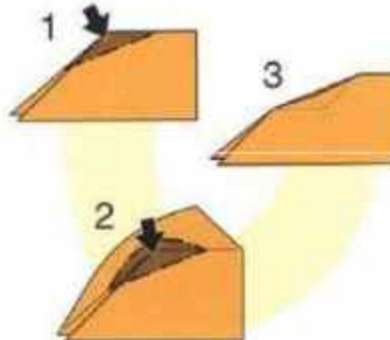

Spread Sink

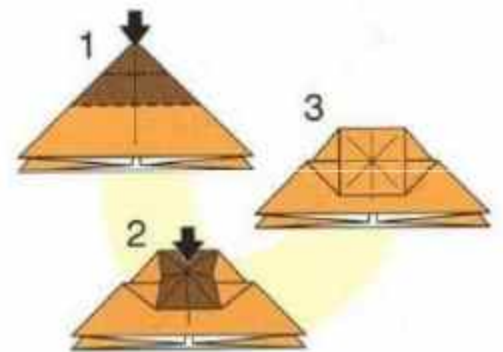

나방파리

Moth fly

- Creator : 맹형규(Maeng Hyeong Kyu)
- Diagram : 맹형규(Maeng Hyeong Kyu)
- Size : 15cm x 15cm

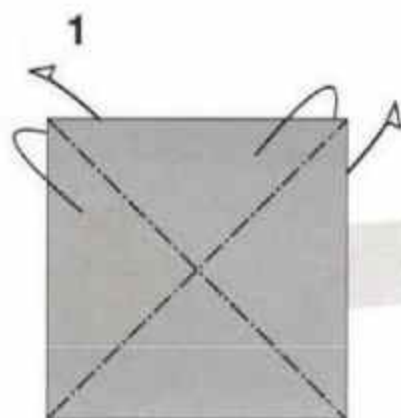
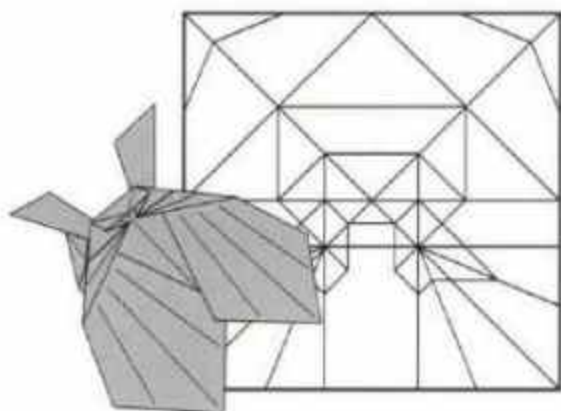

뒤쪽으로 접었다 펴주세요.

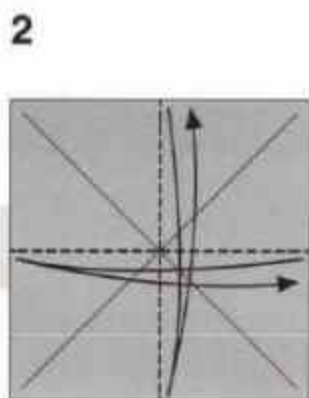

안쪽으로 접었다 펴주세요.

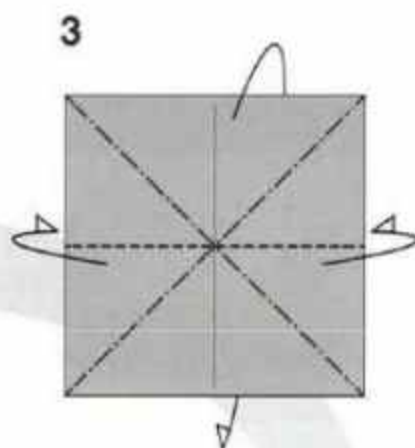

삼각주머니를 만들어주세요.

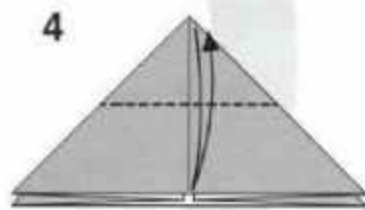

아래로 접었다 펴주세요.

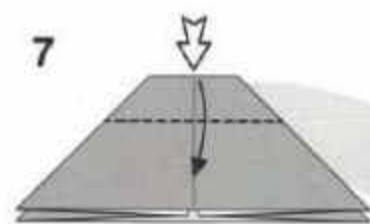

아래로 펼쳐 내려주세요.

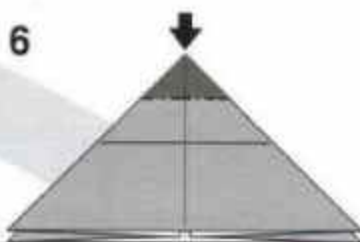

함몰집기 해주세요.



아래로 접었다 펴주세요.



위로 접었다 펴주세요.



위로 올려주세요.



위로 올려주세요.

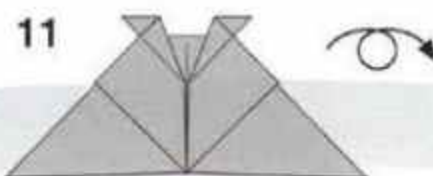

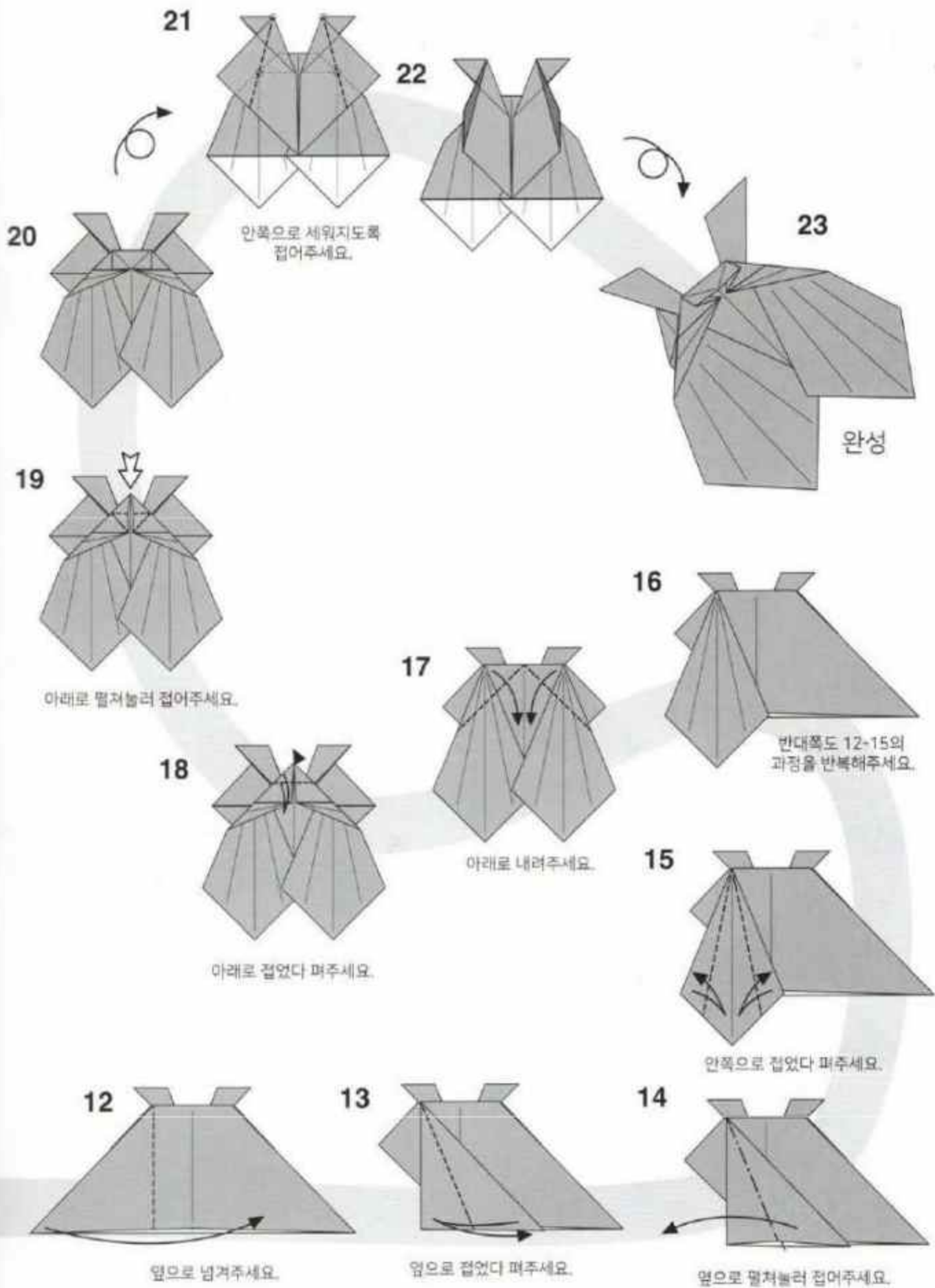

나비

Butterfly

- Creator : 한지우(Han Ji Woo)
- Diagram : 정재일(Jeong Jae Il)
- Size : 30cm x 30cm

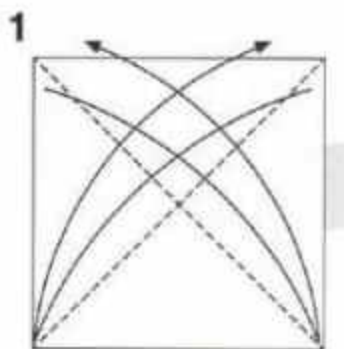
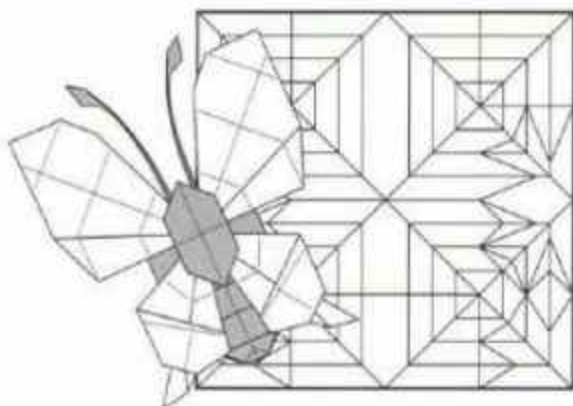

1 대각선으로 접었다가 펼쳐주세요.

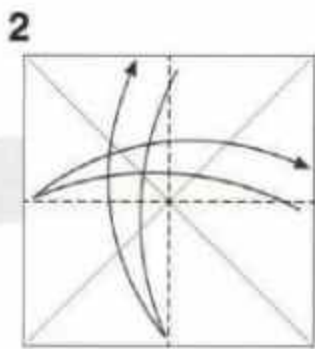

2 반으로 접었다가 펼쳐주세요.

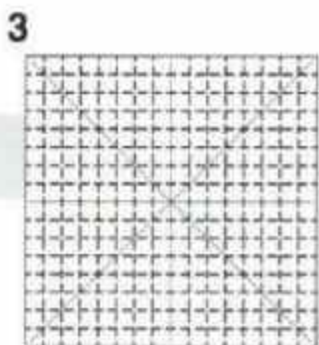

3 16등분해주세요.

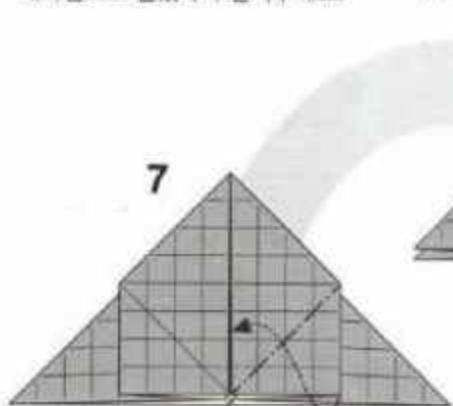

4 선을 따라 접었다가 펼쳐주세요.

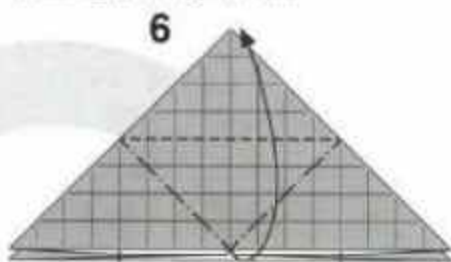

5 화살표를 따라 위로 들어 접어주세요.

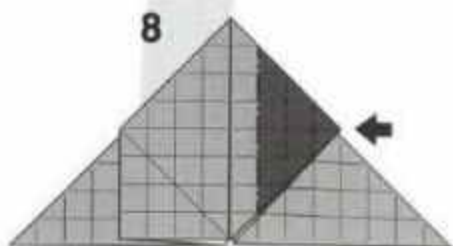

6 안쪽으로 펼쳐 눌러 접어주세요.

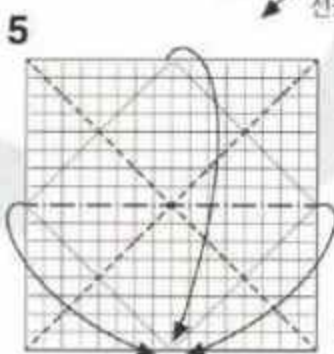

7 선을 따라 접어주세요.



8 함몰접기 해주세요.
(Sink In and Out)

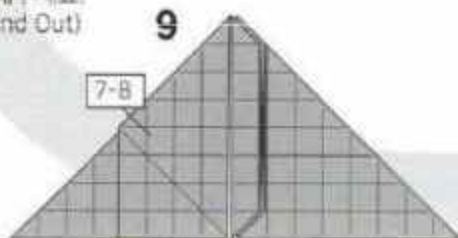

9 반대쪽도 7-8을 반복해주세요.

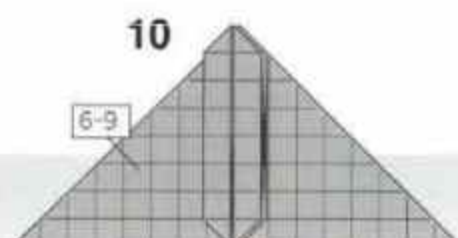

10 뒤쪽도 6-9을 반복해주세요.

23

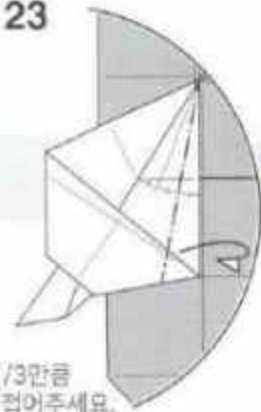

1/3만큼 뒤로 접어주세요.



22

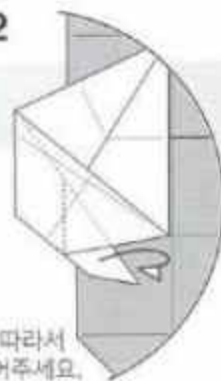

점선을 따라서 뒤로 접어주세요.

21

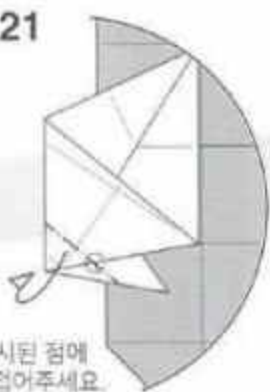

표시된 점에 맞춰 접어주세요.

20

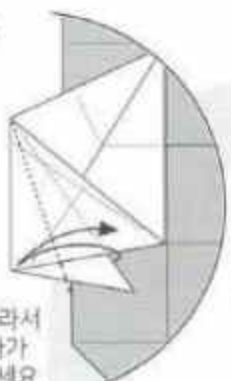

선을 따라서 접었다가 펼쳐주세요.

16

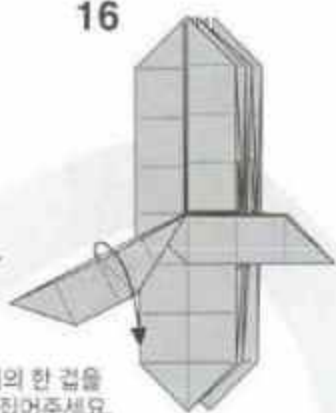

위의 한 겹을 뒤집어주세요.

17

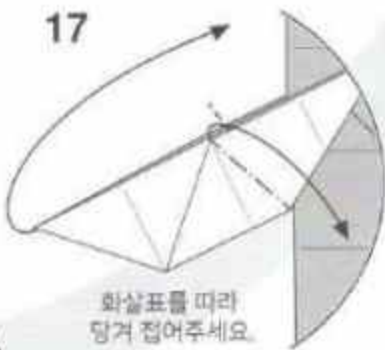

화살표를 따라 밑거 접어주세요.

19



표시된 점에 맞춰 접어주세요.

18

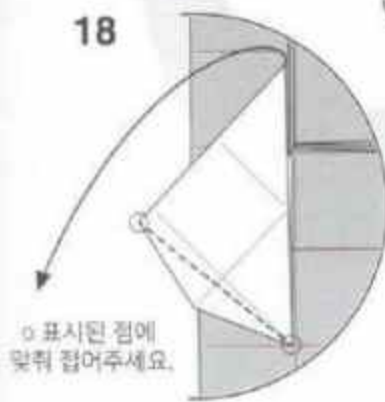

표시된 점에 맞춰 접어주세요.

15

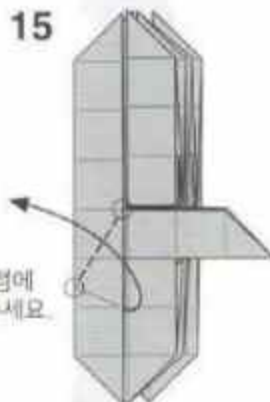

표시된 점에 맞춰 접어주세요.

14

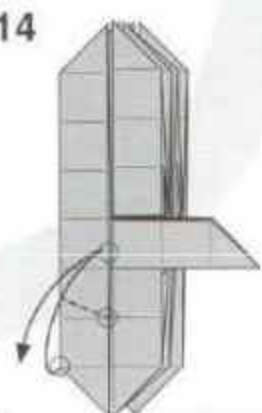

표시를 기준으로 접었다가 펼쳐주세요.

13

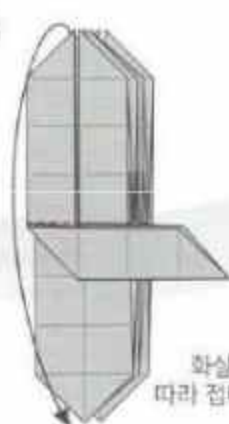

화살표를 따라 접어주세요.

12

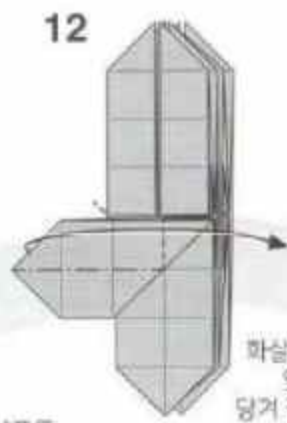

화살표를 따라 옆으로 밑거 접어주세요.

11

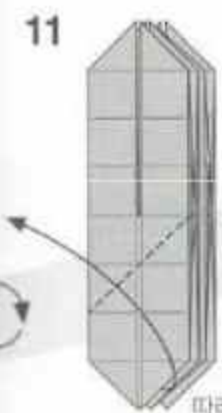

화살표를 따라 접어주세요.

24

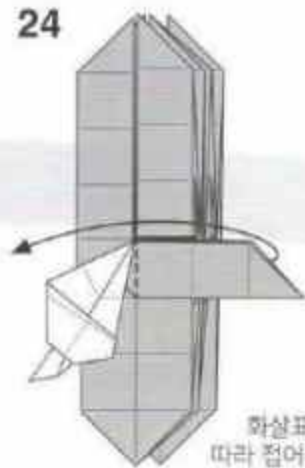

화살표를 따라 접어주세요.

25

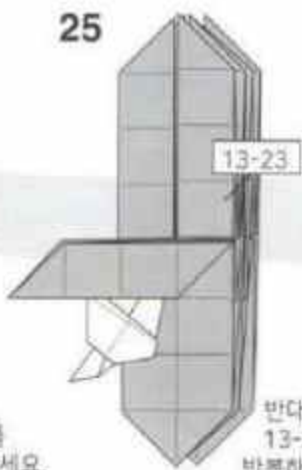

13-23

반대쪽도 13-23을 반복해주세요.

26

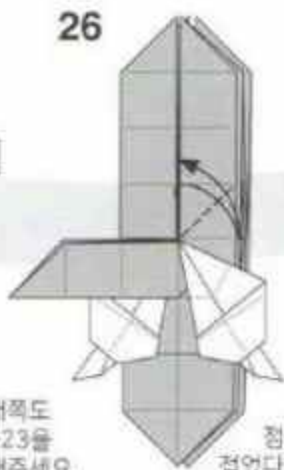

점선을 따라 접었다가 펼쳐주세요.

27

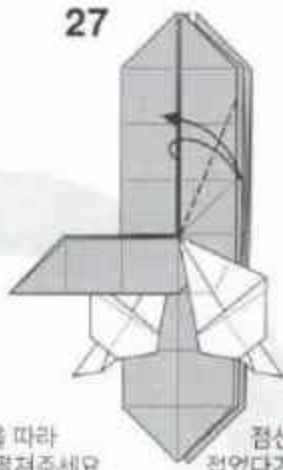

점선을 따라 접었다가 펼쳐주세요.

31

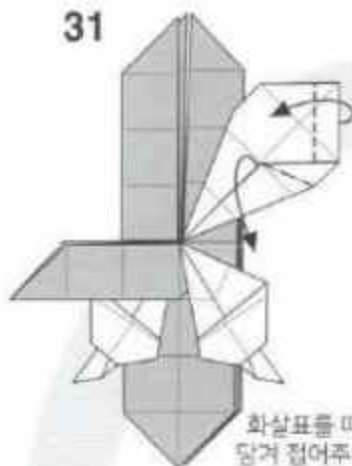

화살표를 따라 당겨 접어주세요.

30

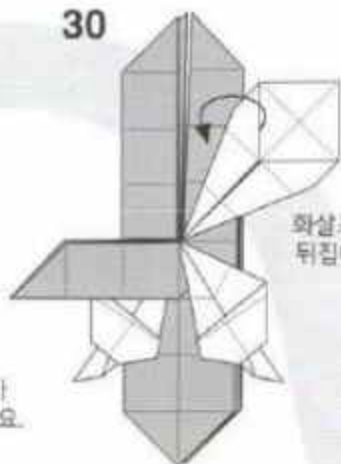

화살표를 따라 뒤집어주세요.

28

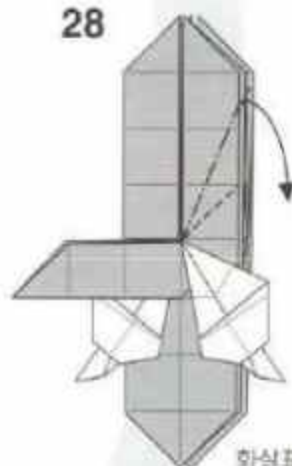

화살표를 따라 당겨 접어주세요.

32

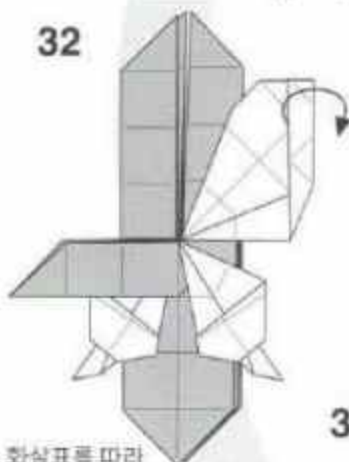

화살표를 따라 뒤집어주세요.

29

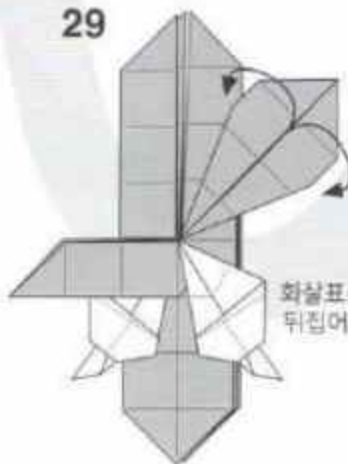

화살표를 따라 뒤집어주세요.

33

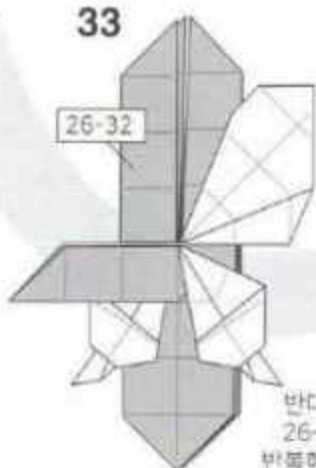

26-32

반대쪽도 26-32을 반복해주세요.

34

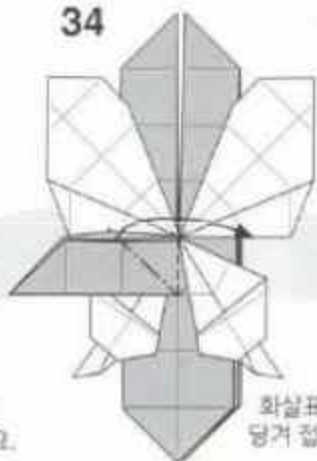

화살표를 따라 당겨 접어주세요.

35

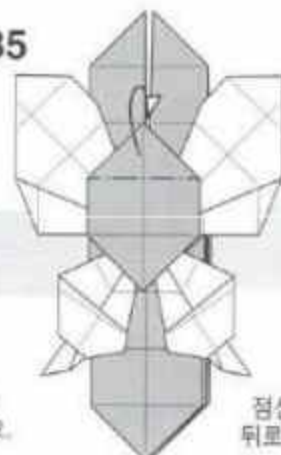

점선을 따라서 뒤로 접어주세요.

43

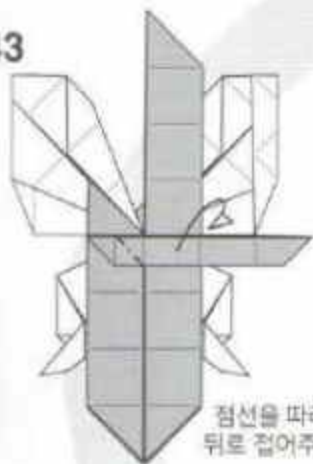

점선을 따라서
뒤로 접어주세요.

44

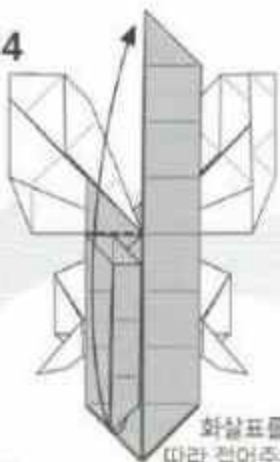

화살표를
따라 접어주세요.

45

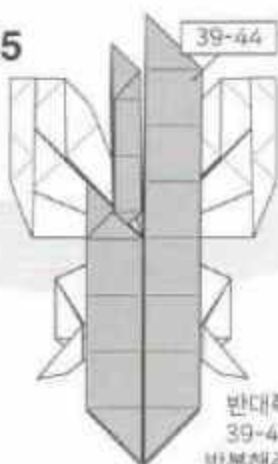

반대쪽도
39-44를
반복해주세요.

46

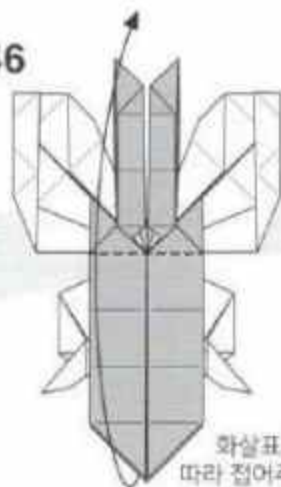

화살표를
따라 접어주세요.

40

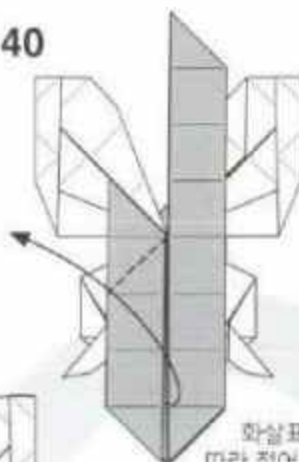

화살표를
따라 접어주세요.

42



화살표를 따라
앞으로
접어주세요.

41

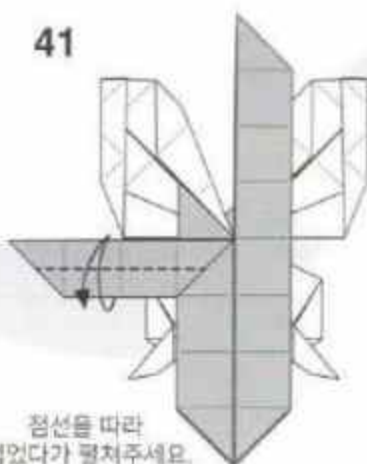

점선을 따라
접었다가 펼쳐주세요.

39

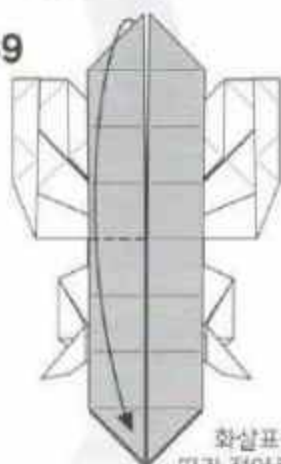

화살표를
따라 접어주세요.

36

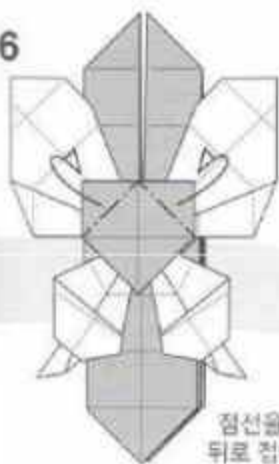

점선을 따라서
뒤로 접어주세요.

37

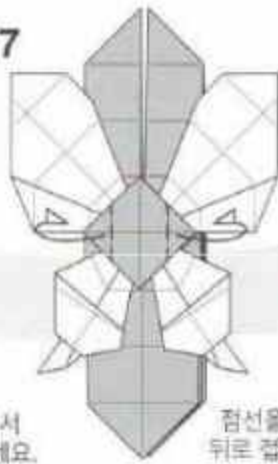

점선을 따라서
뒤로 접어주세요.

38

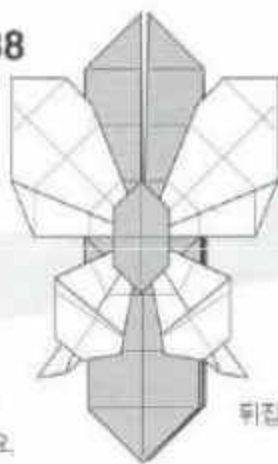

뒤집어주세요.

47

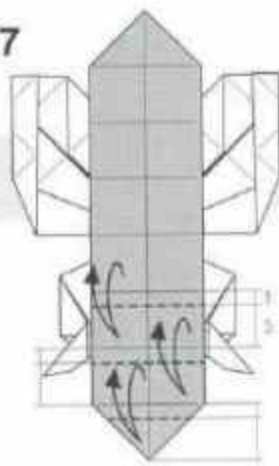

세 칸을 각각
1/4만큼 접어주세요.

48

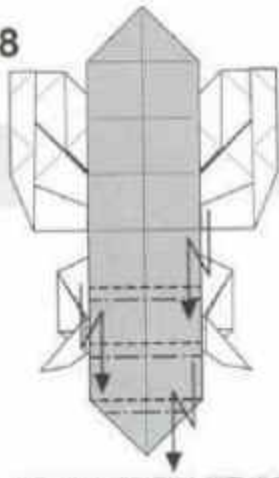

선을 따라 계단접기 해주세요.

49

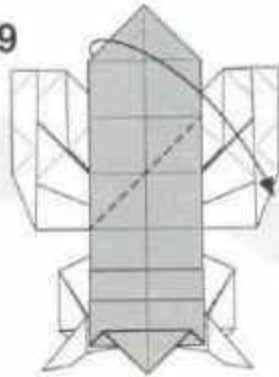

화살표를 따라 접어주세요.

50

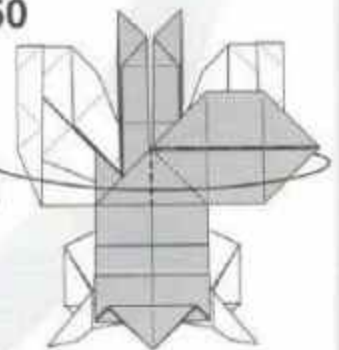

화살표를 따라
앞으로
당겨 접어주세요.

52

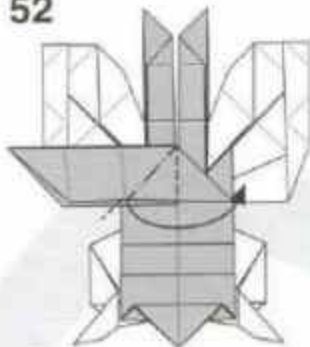

화살표를 따라
당겨 접어주세요.

51

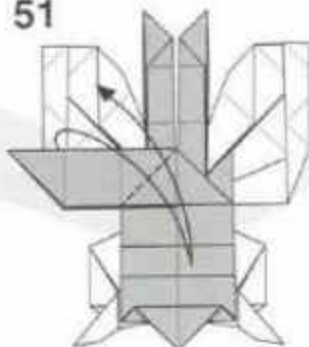

점선을 따라
접었다가 펼쳐주세요.

57

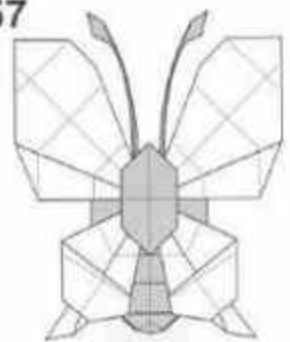

완성

53

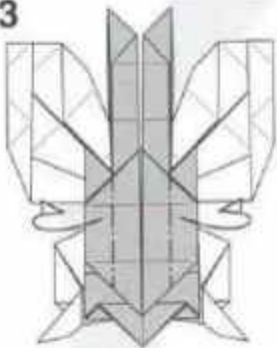

점선을 따라서
뒤로 접어주세요.

54

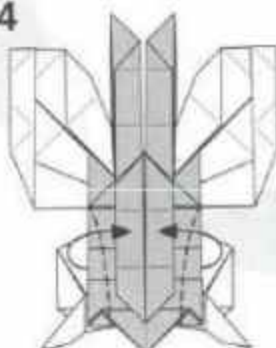

점선을 따라
입체적으로 접어주세요.

55

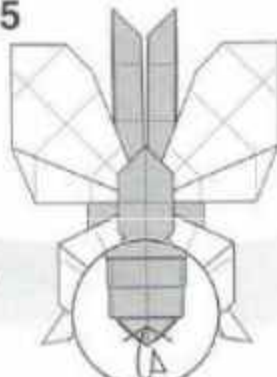

점선을 따라
입체적으로 접어주세요.

56

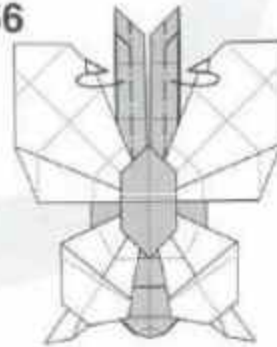

점선을 따라
입체적으로 접어주세요.

소드

Sword

- Creator : 이민섭(Lee In Seop)
- Diagram : 이민섭(Lee In Seop)
- Size : 30cm x 30cm

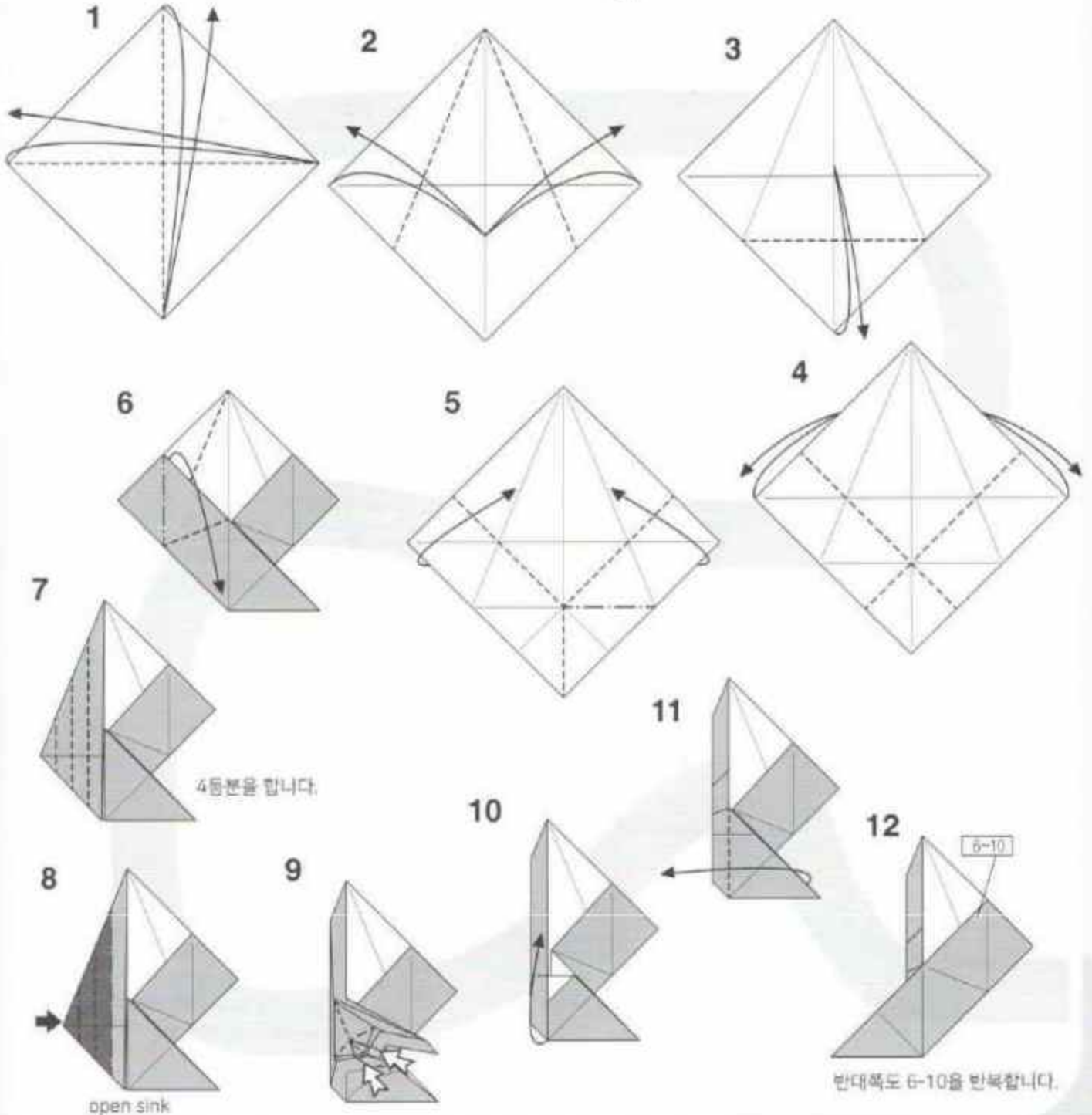
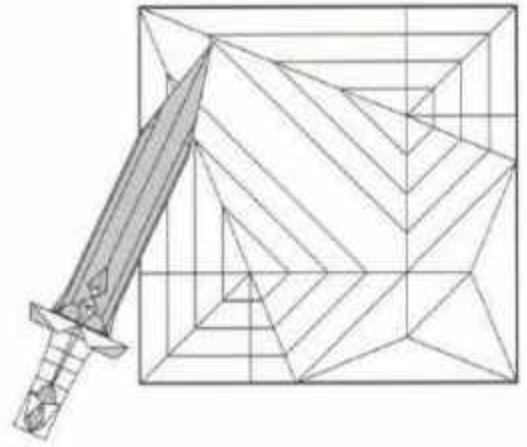

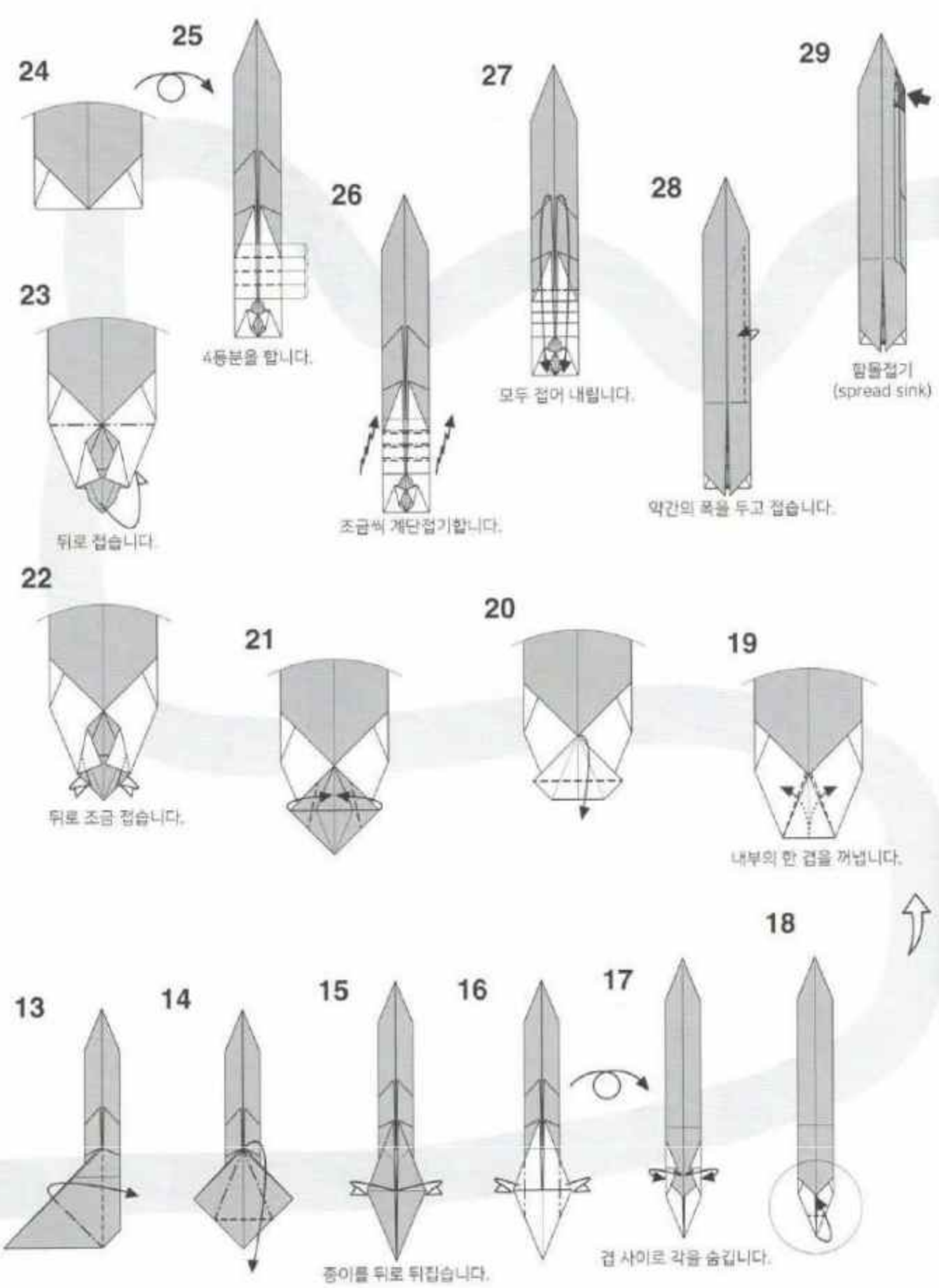

24 25

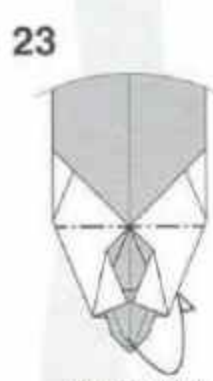
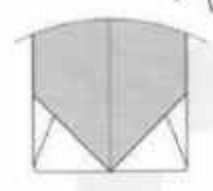

뒤로 접습니다.

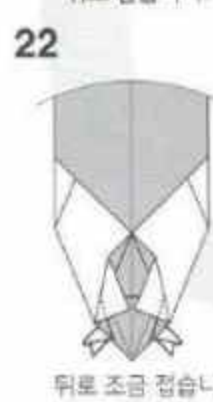

뒤로 조금 접습니다.

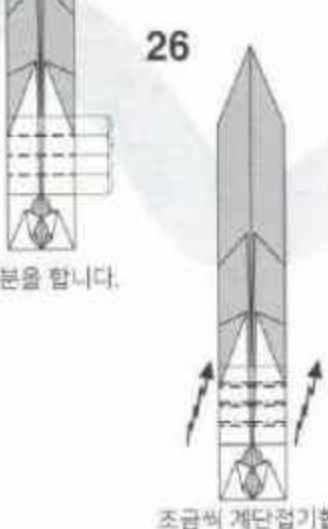

조금씩 계단접기합니다.

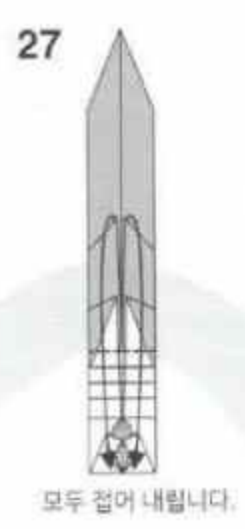

모두 접어 내립니다.

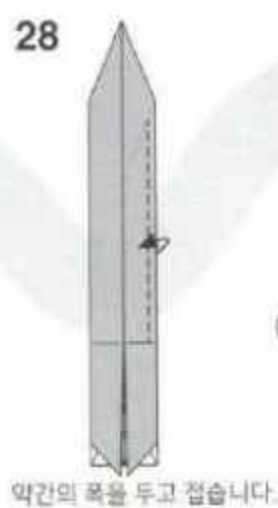

약간의 폭을 두고 접습니다.

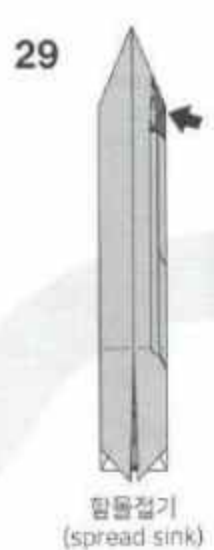

힘들접기 (spread sink)

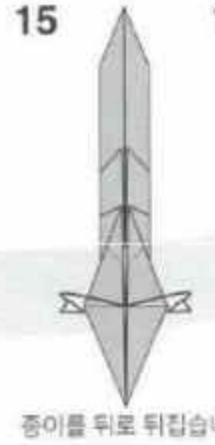
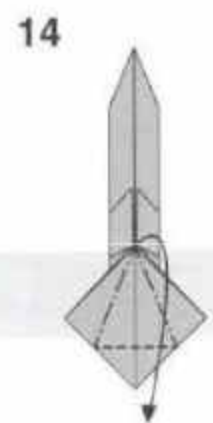
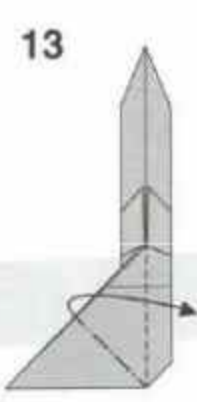

종이를 뒤로 뒤집습니다.

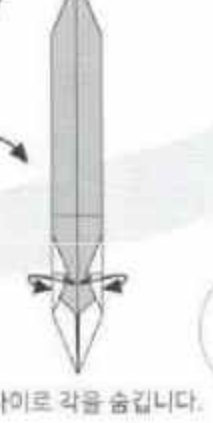
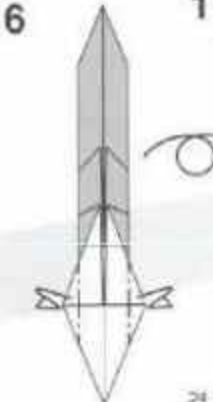

겹 사이로 각을 숨깁니다.

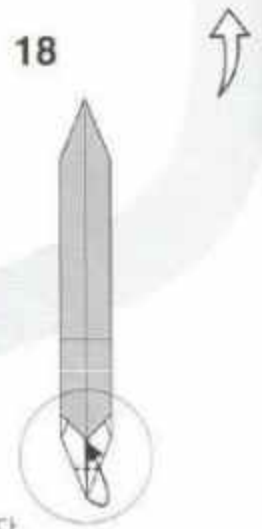

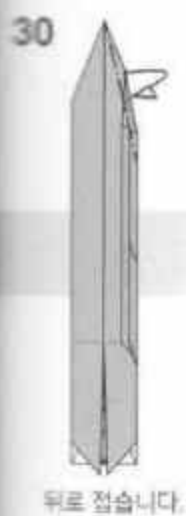

뒤로 접습니다.



뒤로 접습니다.

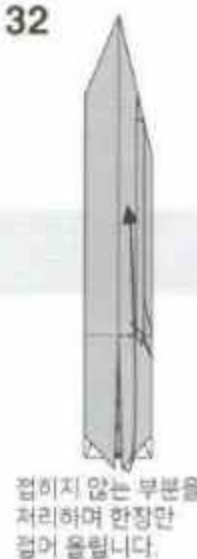

접히지 않는 부분을
처리하여 한장만
접어 올립니다.



반대쪽도 28-32를
반복합니다.

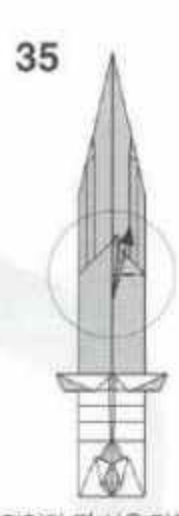
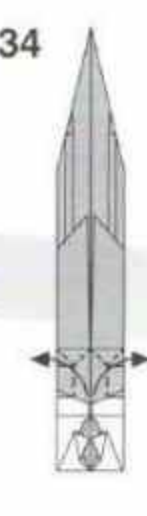

접었다 편 선을 만듭니다.

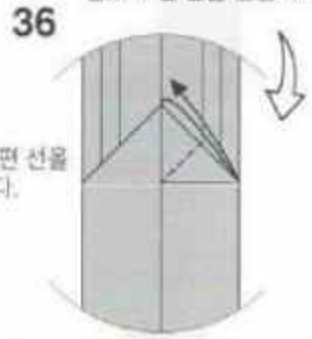

접었다 편 선을
만듭니다.

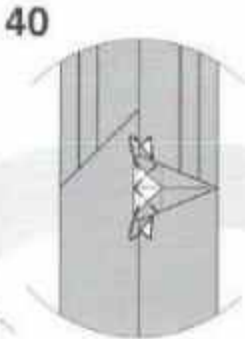

뒤로 접습니다.

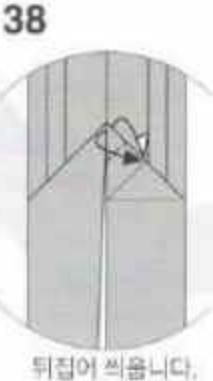

뒤집어 씌웁니다.

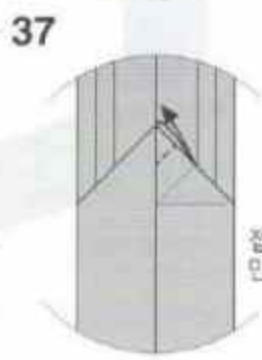

이
부분
만
접
어
올
립니다.

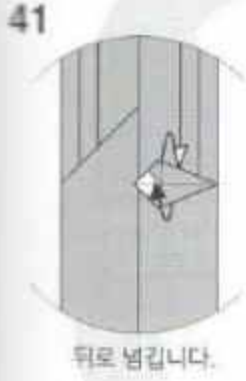

뒤로 넘깁니다.

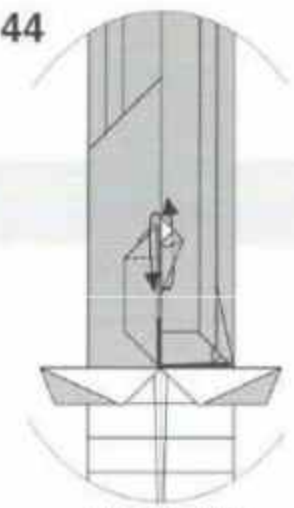
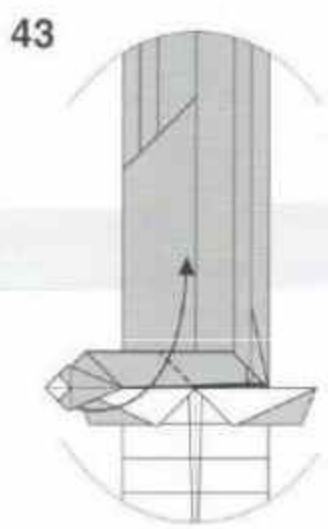
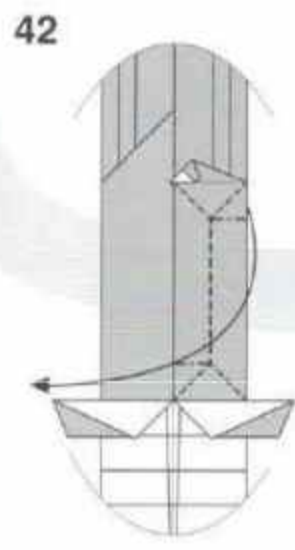

앞으로 접습니다.

53



54

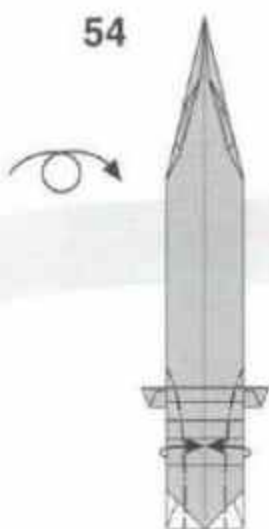

55

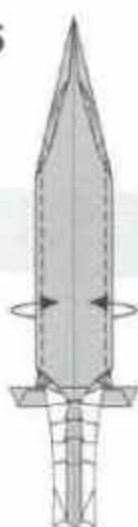

56



57



완성

52

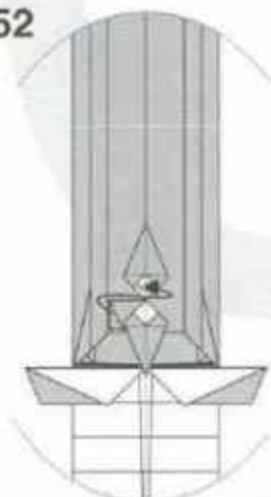

안으로 끼워넣습니다.

51

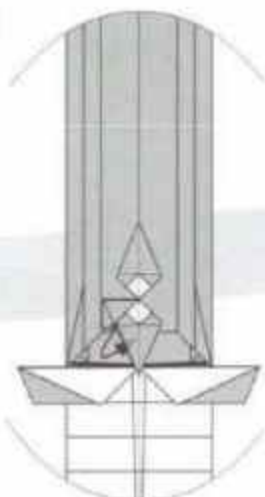

뒷장을 한 장 앞으로 보냅니다.

50

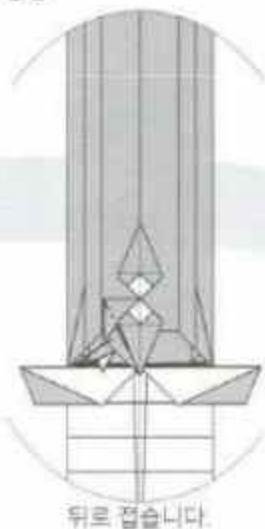

뒤로 접습니다.

49

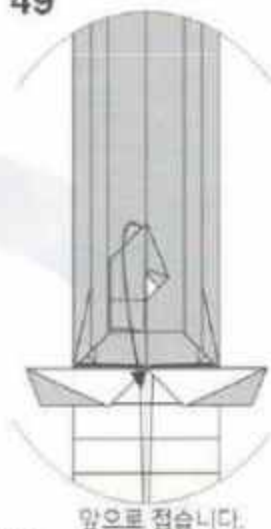

앞으로 접습니다.

45

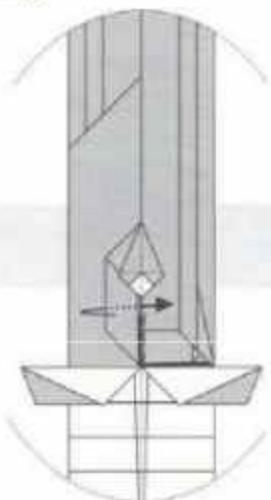

뒤로 접습니다.

46

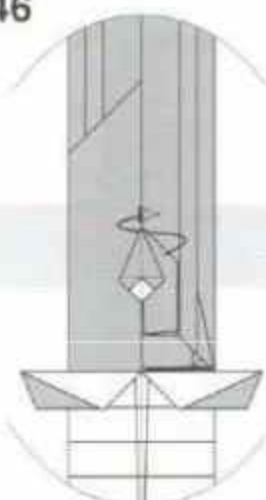

안으로 끼워넣습니다.

47

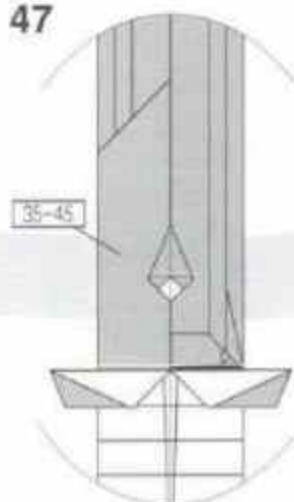

반대쪽도 35-45를 반복합니다.

48

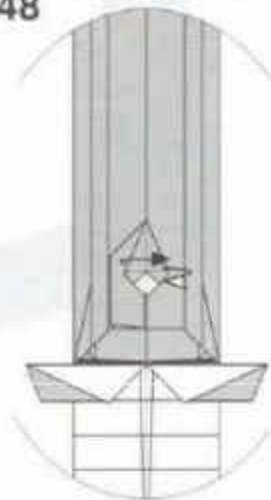

뒤로 넘깁니다.

침묵

Silence

- Creator : 이인섭(Lee In Seop)
- Diagram : 이인섭(Lee In Seop)
- Size : 30cm x 30cm

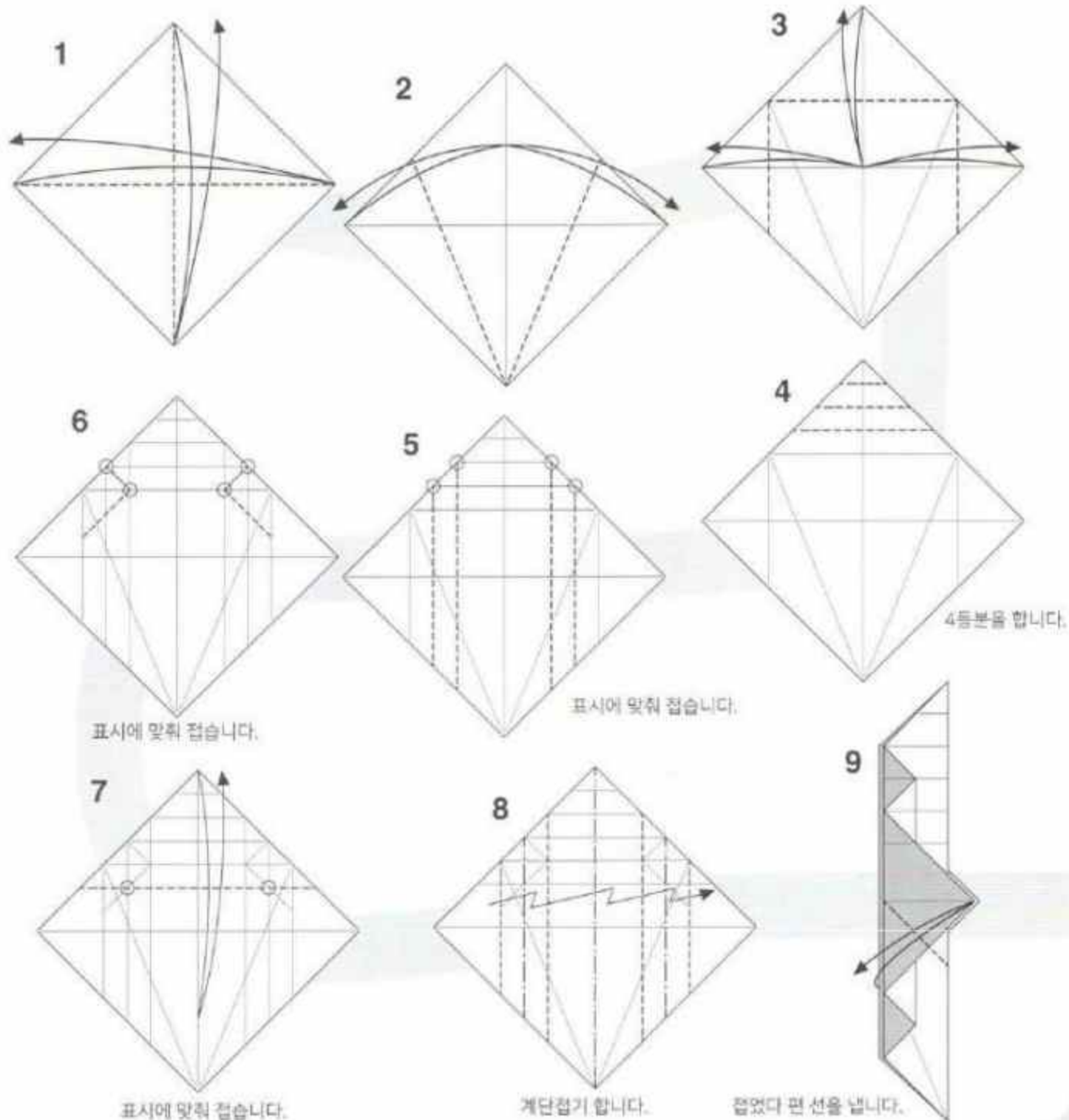
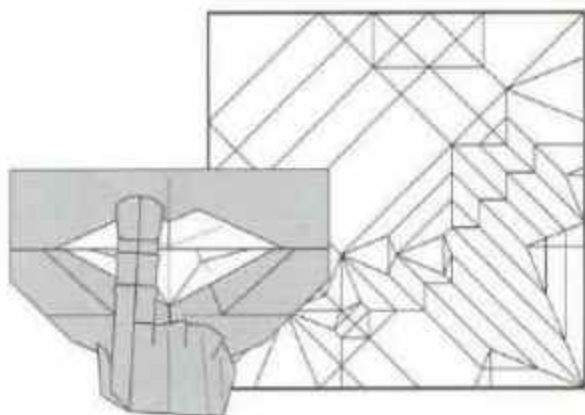

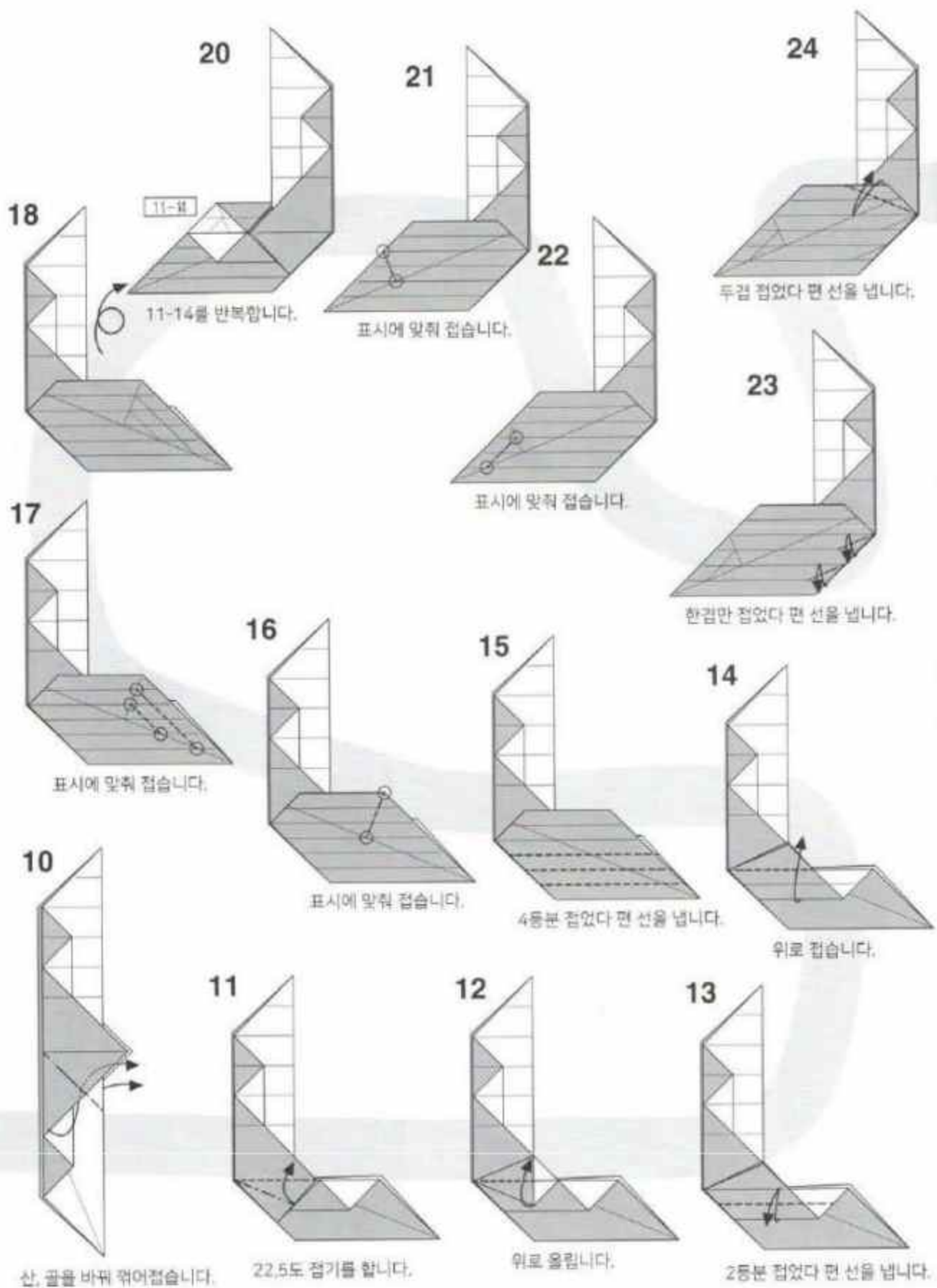

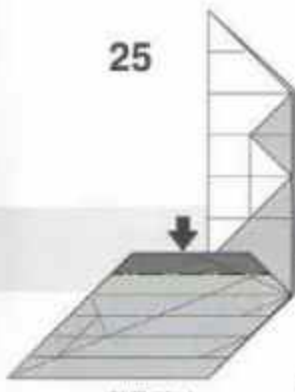

25

함몰잡기
(open sink)

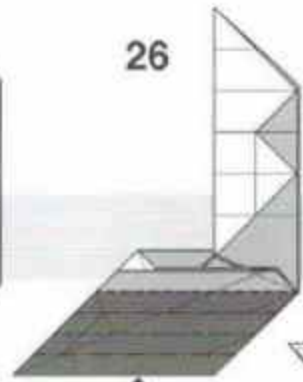

26

함몰잡기
(open sink)

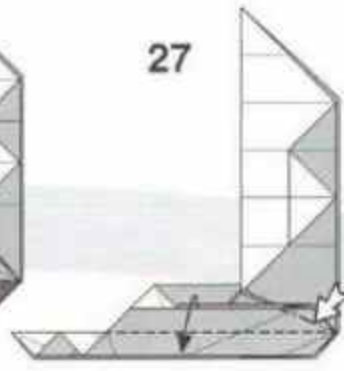

27

옆쪽을 24번 쪽으로 접습니다.

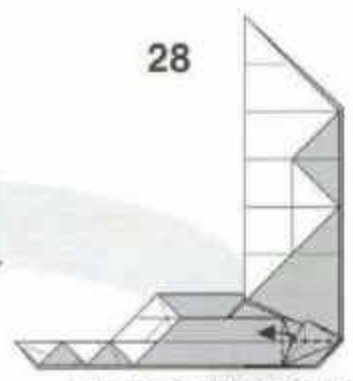

28

동쪽 부분을 평면으로 합니다.

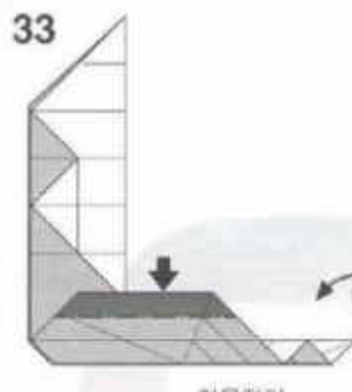

33

함몰잡기
(open sink)

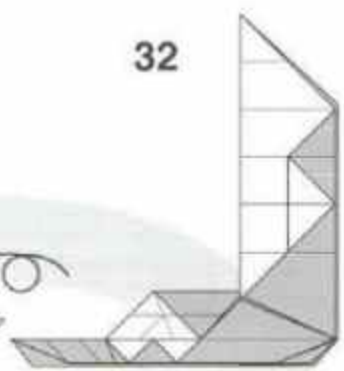

32

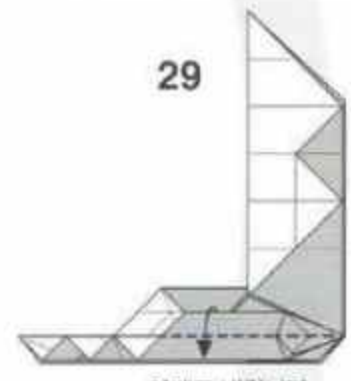

29

아래로 내립니다.

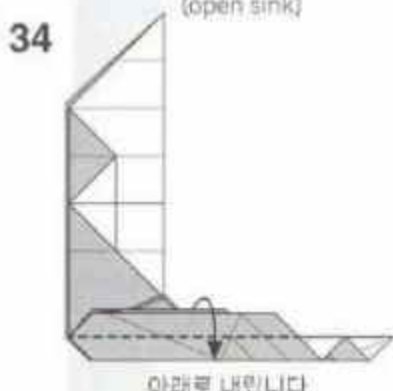

34

아래로 내립니다.

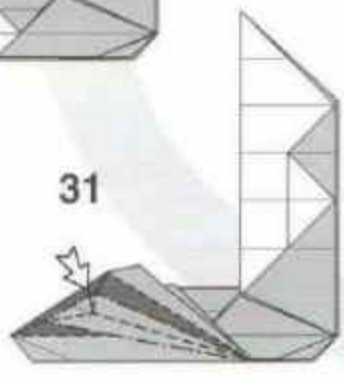

31

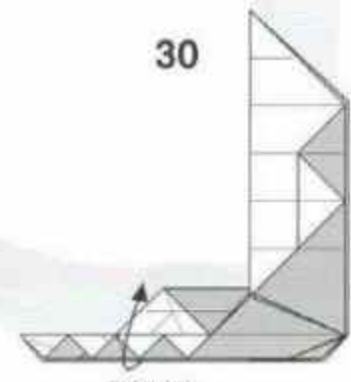

30

펼칩니다.



35

펼칩니다.

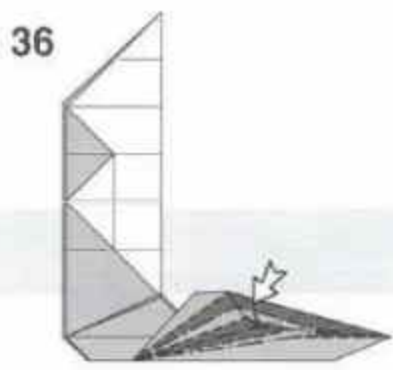

36

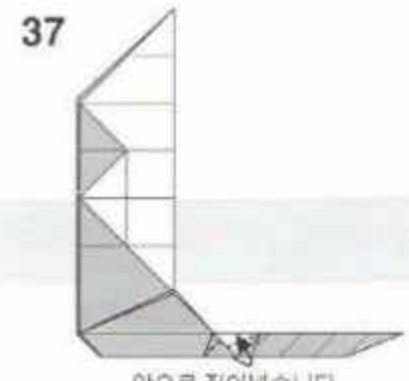

37

안으로 집어넣습니다.

46



왼쪽으로 앞 한장을 펼칩니다.

47

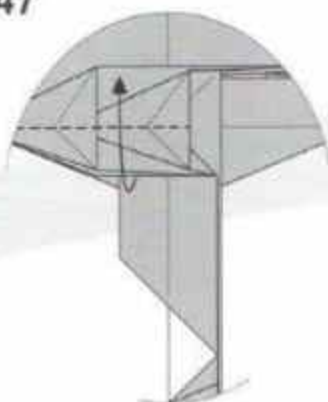

종이를 들어올려 내리도록 합니다.

48

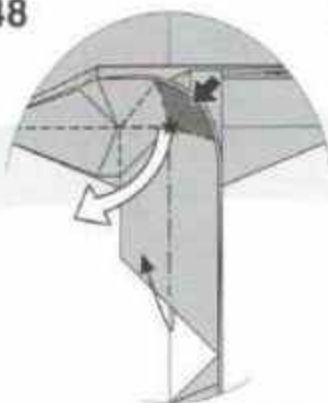

★를 표시하여 주름 한장을 펼칩니다. 다시 종이를 접어 내립니다.

49



45

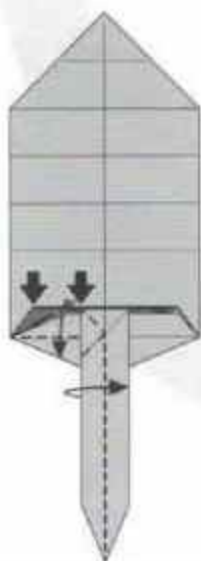

23에서 낸 선을 spread sink 하며 오른쪽으로 넘깁니다.

43

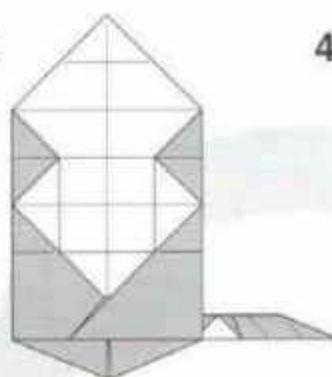

42

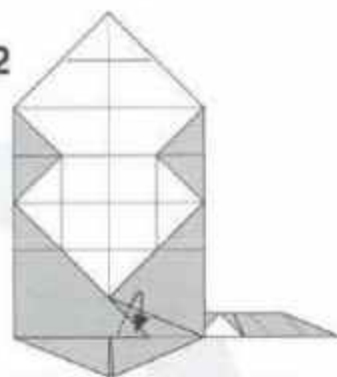

안에 한장을 앞으로 넘깁니다.

44

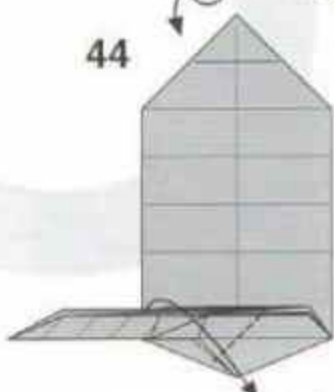

긴 각을 아래로 내리며 펼칩니다.

41

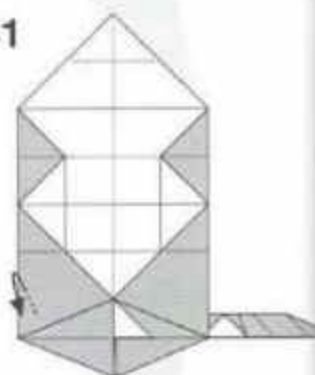

안에 한장을 앞으로 넘깁니다.

38

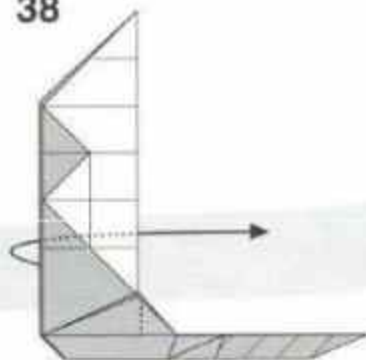

뒤의 한장을 펼칩니다.

39

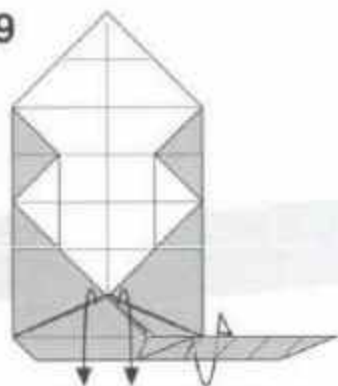

한장씩 잡고 아래로 내리고 긴 각은 뒤로 넘깁니다.

40

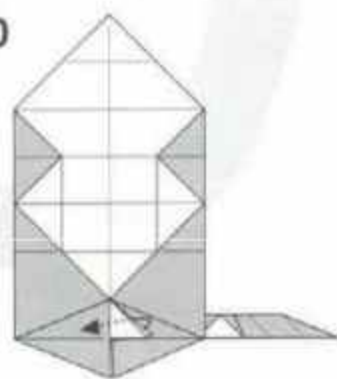

뒤에 한장을 반대쪽으로 넘깁니다.

50



51

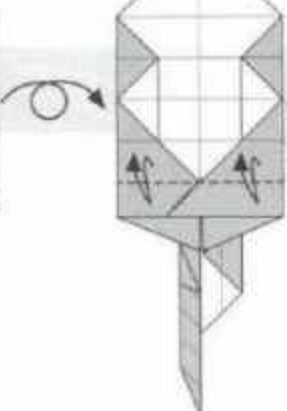

접었다면 선을 냅니다.

52

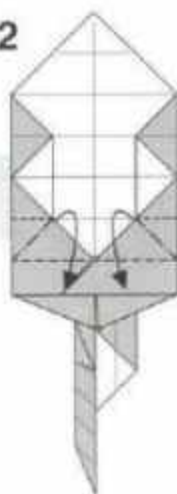

선대로 접습니다.

53

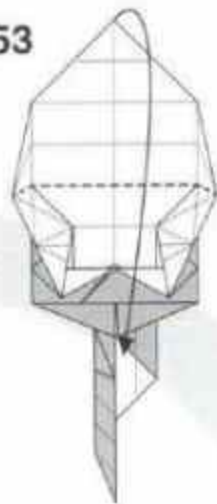

54



접기선을 표시합니다.

56

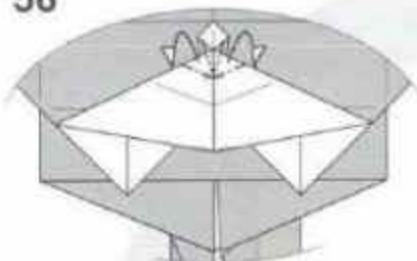

주름을 펼치며 위로 접습니다.

55

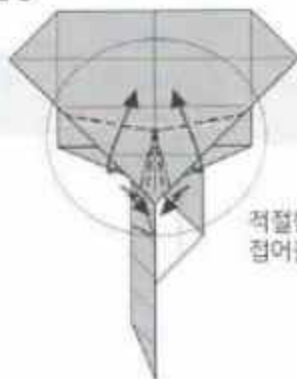

적절한 정도로 접어올립니다.

57

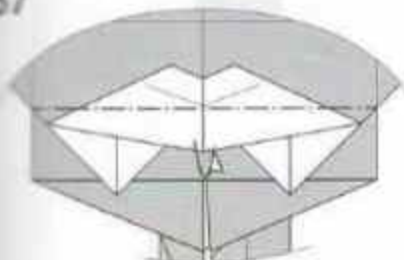

뒤로 넘깁니다.

61



들어 올린 것을 접어 접어 내립니다.

60

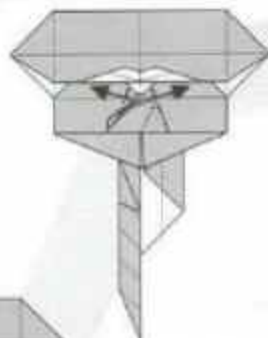

양 옆으로 펼칩니다.

58

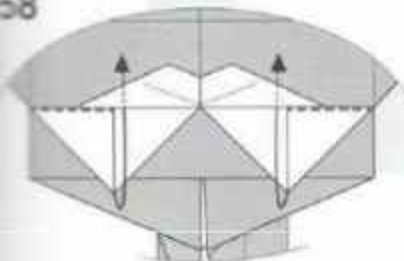

안으로 집어넣습니다.

59

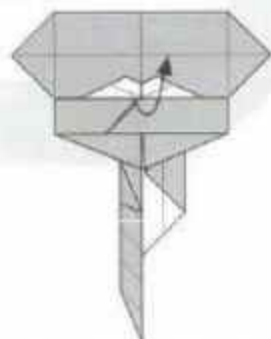

살짝 들어올려 내부를 봅니다.

62

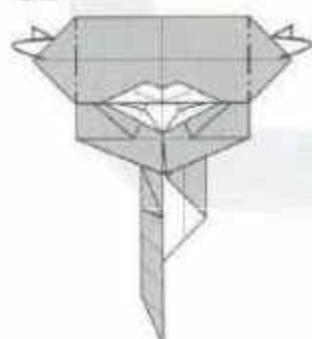

뒤로 접습니다.

71

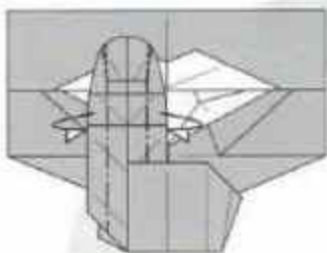

뒤로 접습니다.

72

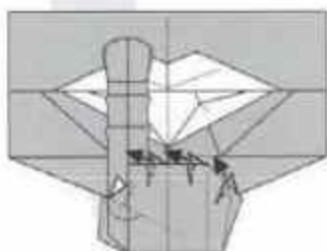

손등을 다듬습니다.

73

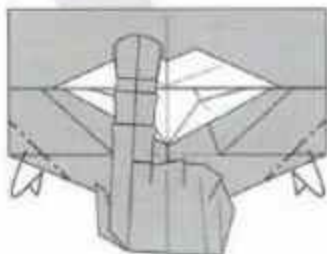

70

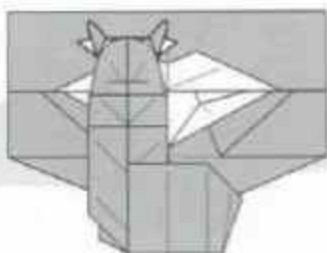

69

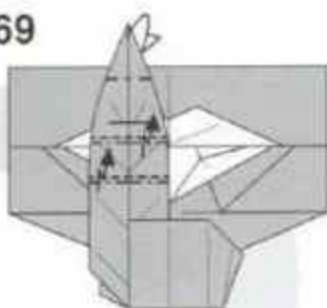

손가락 마디처럼 주름을 내듯 접습니다.

68

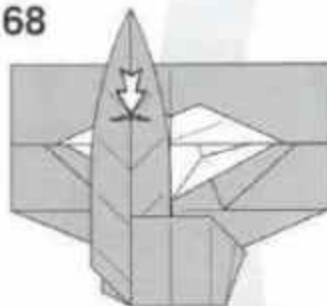

볼록 튀어나온 부분을 정리합니다.

74

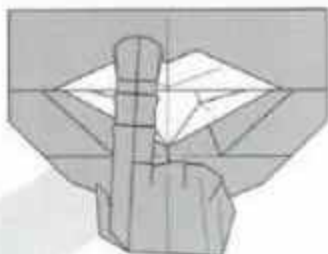

완성

67

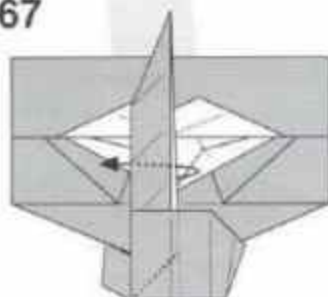

맨 뒤 한장을 반대쪽으로 펼칩니다.

63

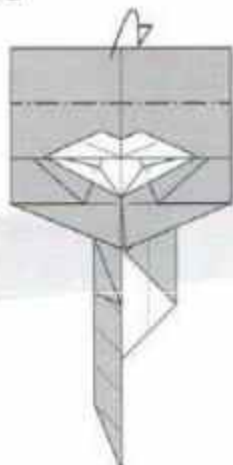

뒤로 접습니다.

64

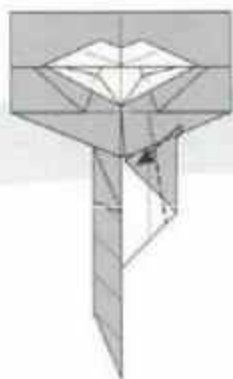

65

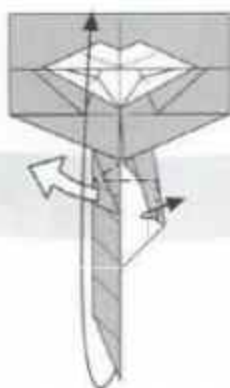

맨 뒤 한장을 안쪽으로 꺾고 64에서
옆면의 손가락 마디를 만들어 줍니다.

66

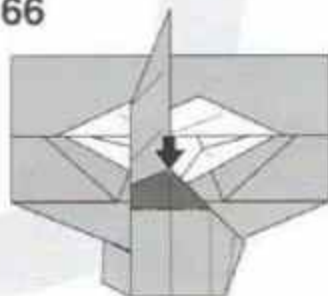

함몰잡기
(closed sink)

마이코

MAIKO

- Creator : 유태용(Yoo Tae Yong)
- Diagram : 유태용(Yoo Tae Yong)
- Size : 25cm x 25cm

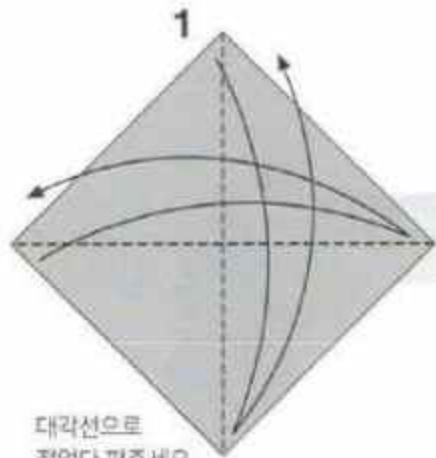
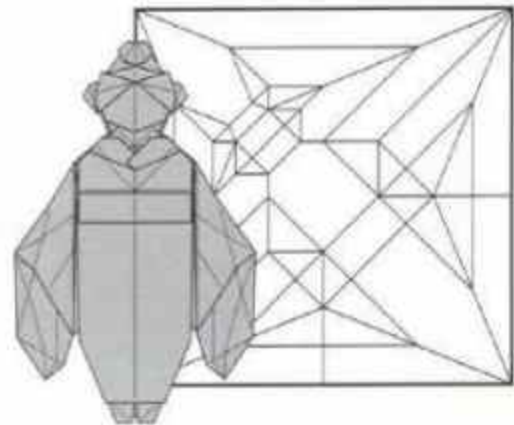

대각선으로
접었다 펴주세요.

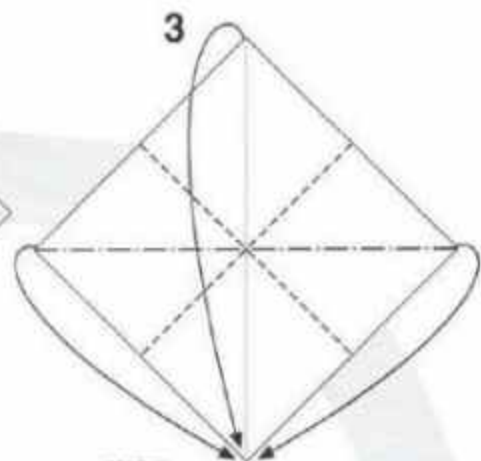
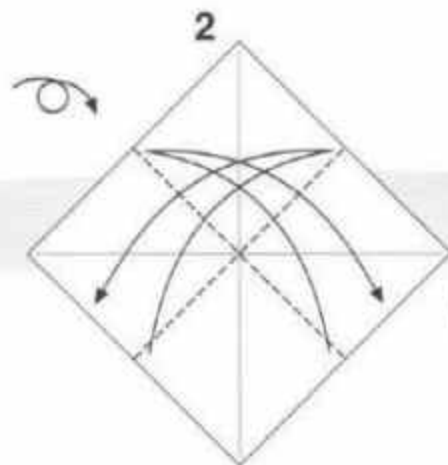

아래로
모아 접어주세요.

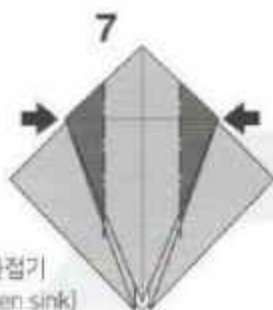

함몰점기
(Open sink)

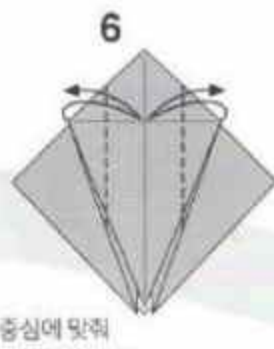

중심에 맞춰
접었다 펴주세요.

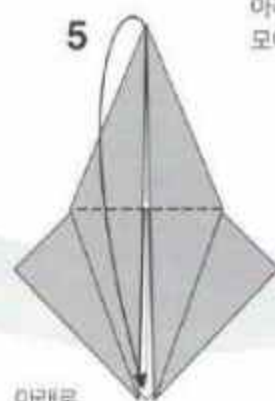

아래로
내려 접어주세요.

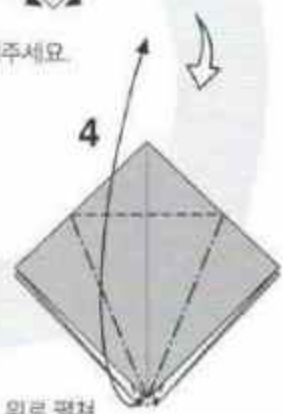

위로 펼쳐
눌러 접어주세요.

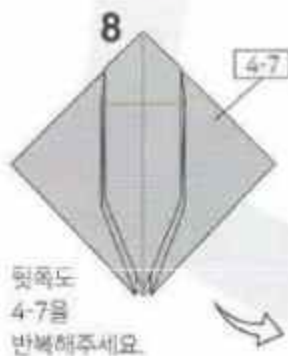

윗쪽도
4-7번
반복해주세요.



○에 맞춰
접었다 펴주세요.

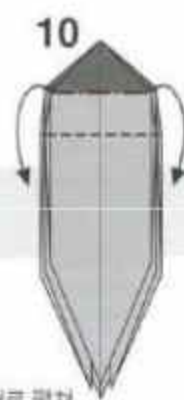

아래로 펼쳐
눌러 접어주세요.

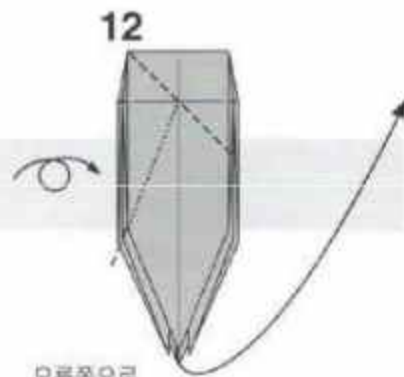

오른쪽으로
펼쳐 눌러 접어주세요.

22

○ 부분에서 수직으로 접어주세요.

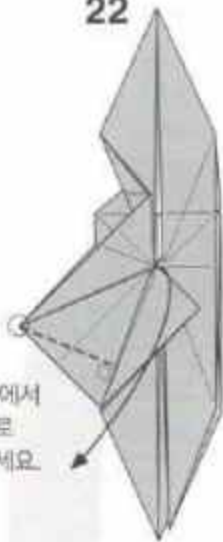

23

안쪽 종이를 밖으로 빼주세요.



24

○에 맞춰 접어주세요.



25



21

○에 맞춰 접어주세요.

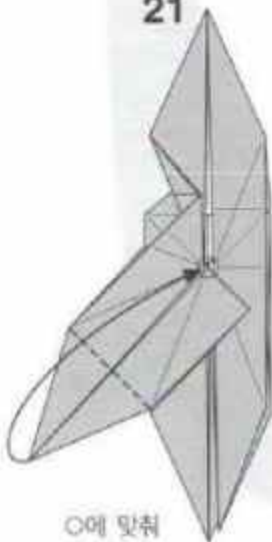

20

안쪽 종이를 밖으로 빼주세요.

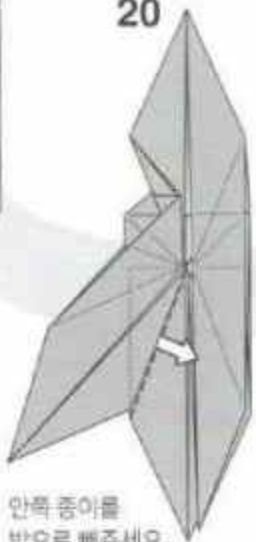

19

계단접기하면서 안쪽 종이를 밖으로 빼주세요.



18

계단접기하면서 안쪽 종이를 밖으로 빼주세요.

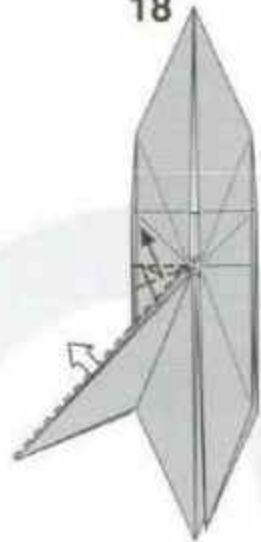

17



왼쪽으로 겹쳐 접어주세요.

13

12번으로 돌아가주세요.

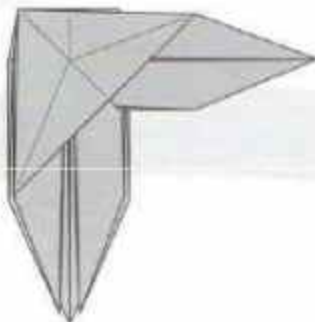

14

반대쪽도 12-13을 반복해주세요.



15

양쪽을 눌러주면서 위로 올려 접어주세요.

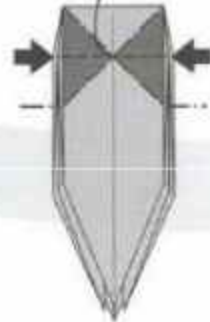

16

위로 올려 접어주세요.



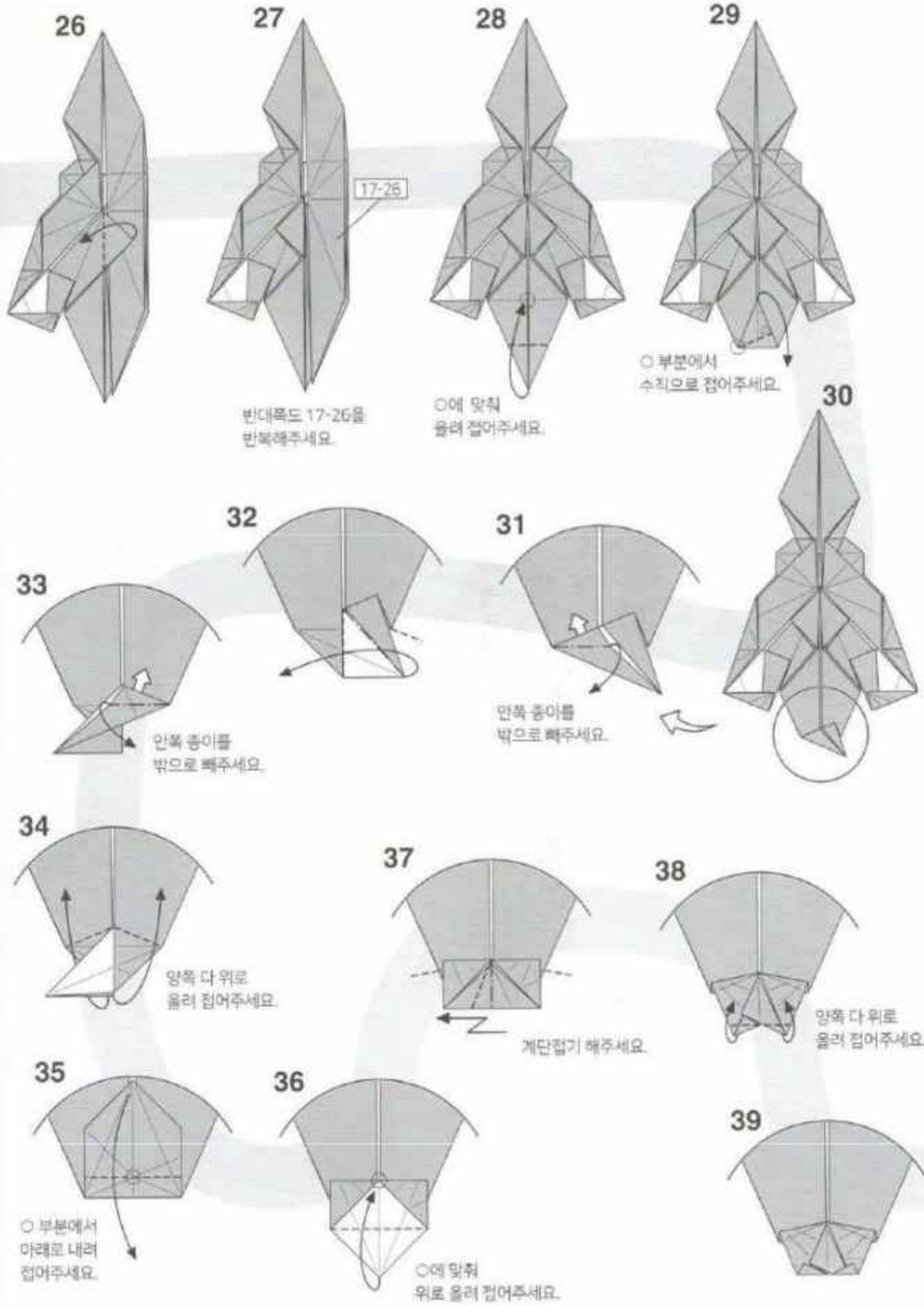

26

27

28

29

17-26

반대쪽도 17-26을
반복해주세요.

○에 맞춰
올려 접어주세요.

○부분에서
수직으로 접어주세요.

30

32

31

33

안쪽 양이름
위로 복주세요.

안쪽 양이름
위로 복주세요.

34

양쪽 다 위로
올려 접어주세요.

37

계단잡기 해주세요.

38

양쪽 다 위로
올려 접어주세요.

35

○부분에서
아래로 내려
접어주세요.

36

○에 맞춰
위로 올려 접어주세요.

39

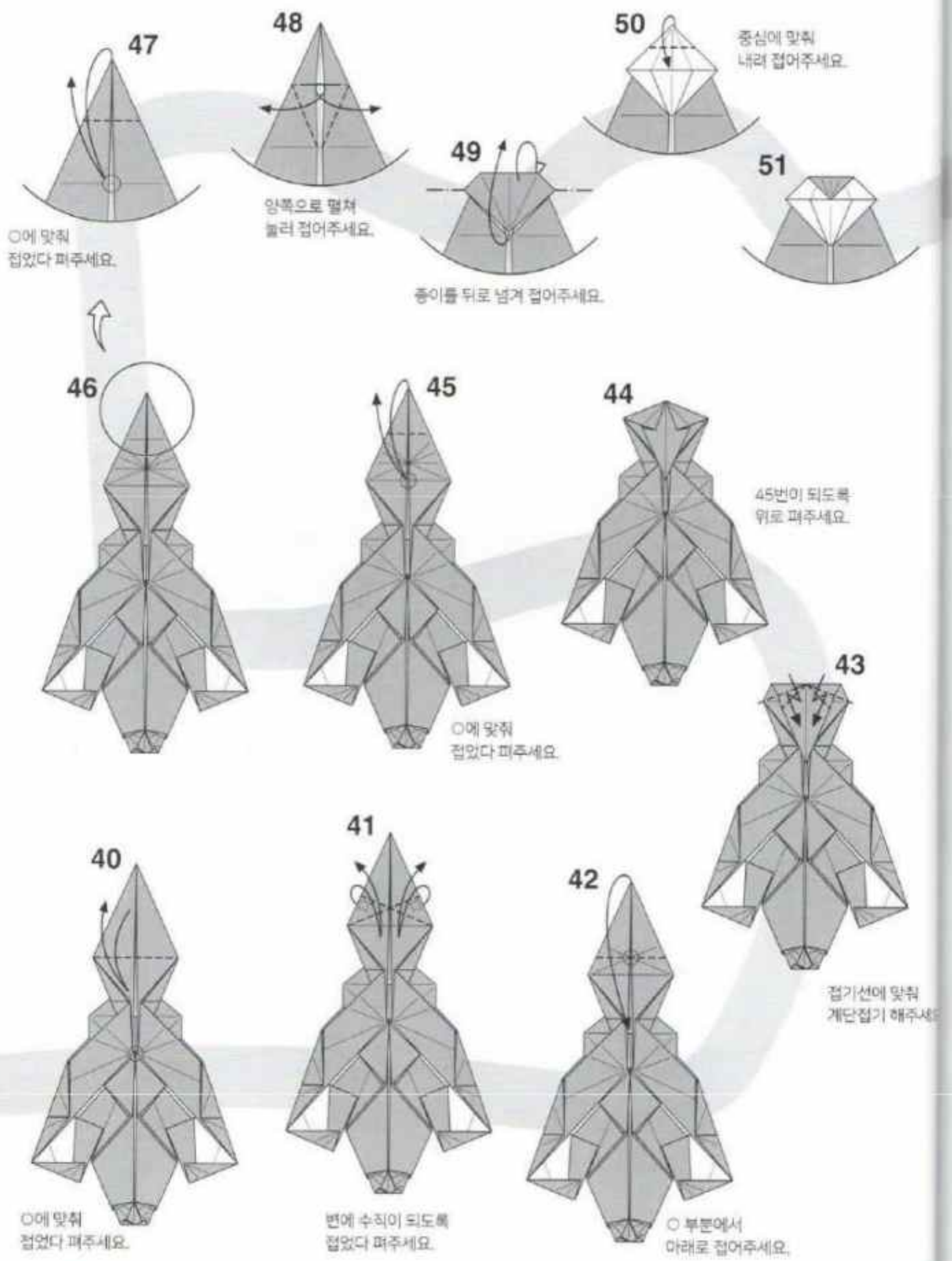

○에 맞춰
접었다 펴주세요.

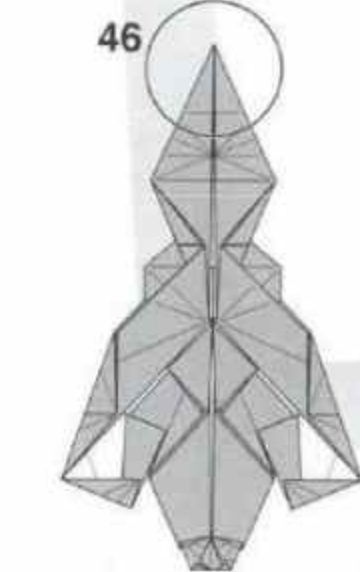

양쪽으로 펼쳐
눌러 접어주세요.

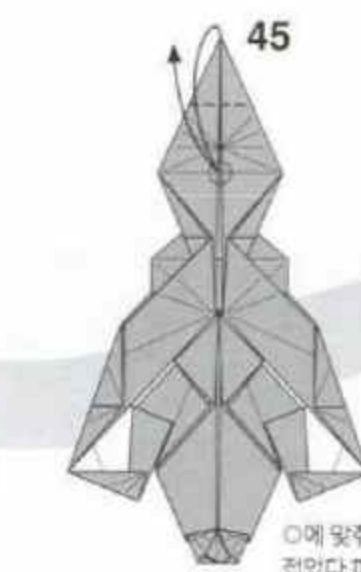

종이를 뒤로 넘겨 접어주세요.

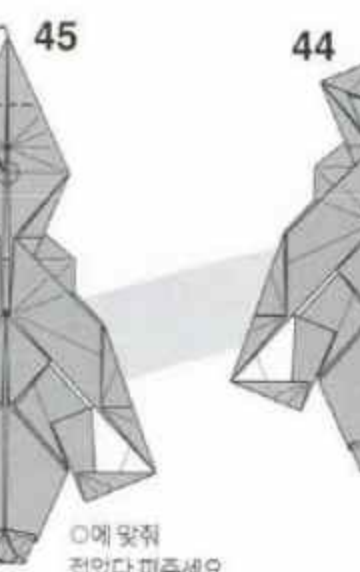

중심에 맞춰
내려 접어주세요.



45번이 되도록
위로 펴주세요.

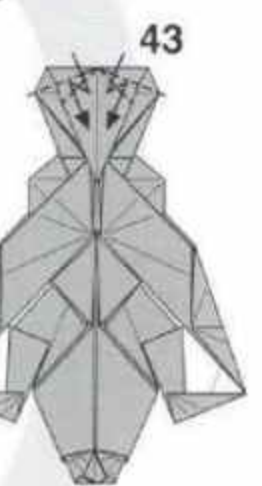

○에 맞춰
접었다 펴주세요.

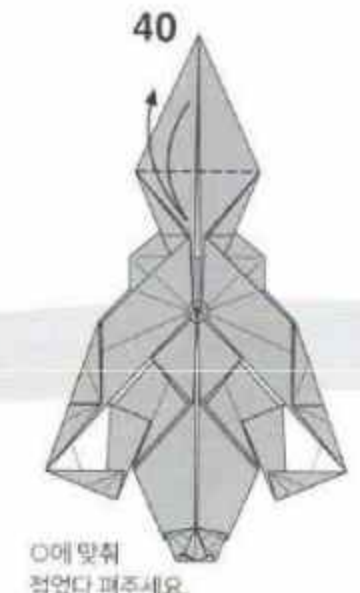

○에 맞춰
접었다 펴주세요.

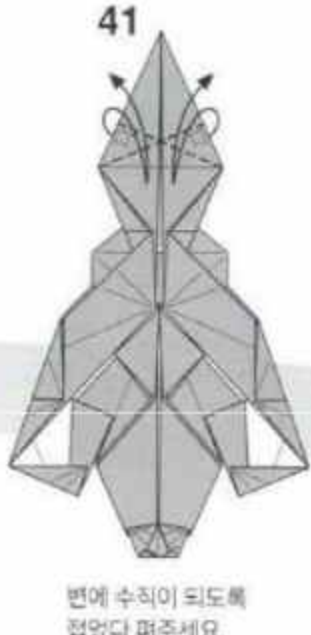

변에 수직이 되도록
접었다 펴주세요.

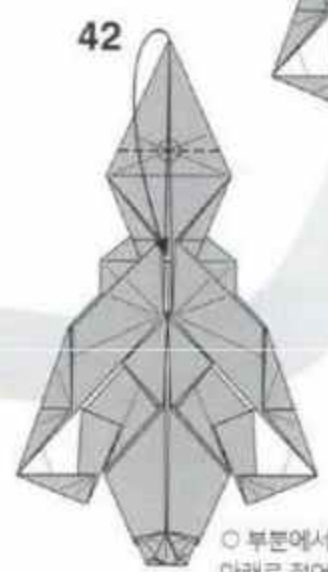

○ 부분에서
아래로 접어주세요.

접기선에 맞춰
계단집기 해주세요.

52



53

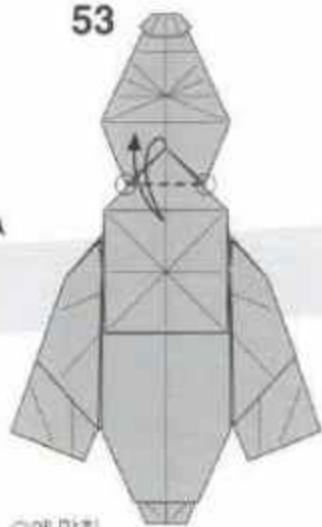

○에 맞춰
접었다 펴주세요.

54

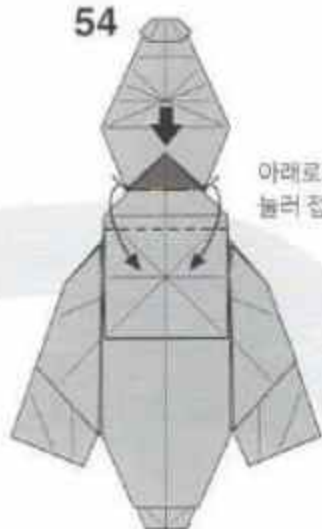

아래로 펼쳐
넓히주세요.

55

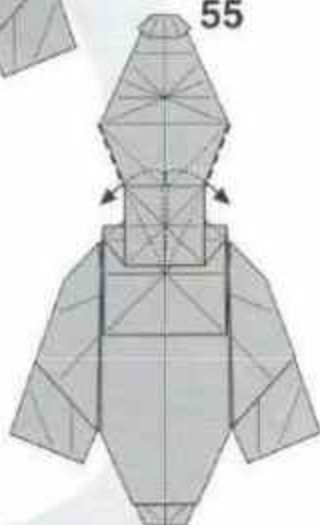

안에 겹쳐있는
종이를 밖으로
빼주세요.

58

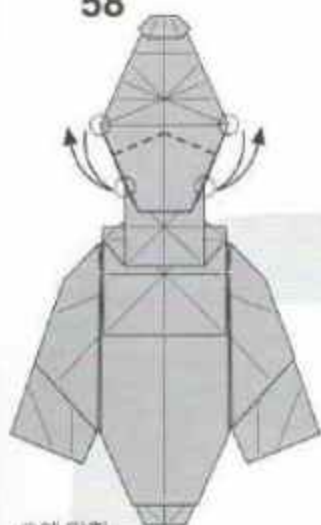

○에 맞춰
접었다 펴주세요.

57

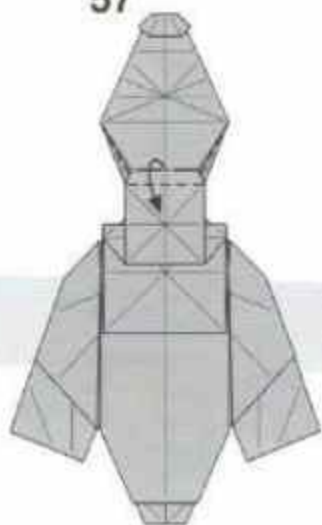

(중간과정)

56

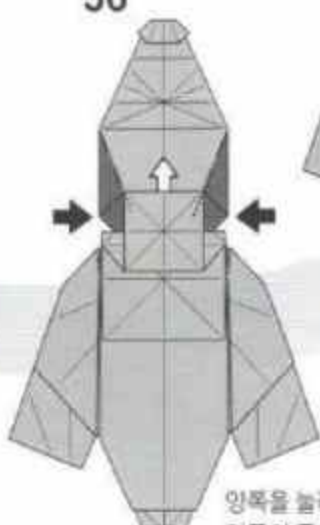

양쪽을 눌러주면서
안쪽의 종이를 밖으로
빼주세요.

59

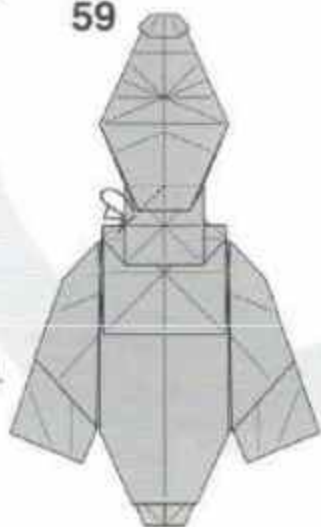

종이를 뒤로
넘겨주세요.

60

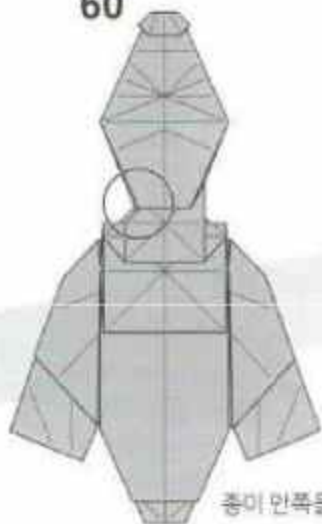

종이 안쪽을 빼주세요.

61

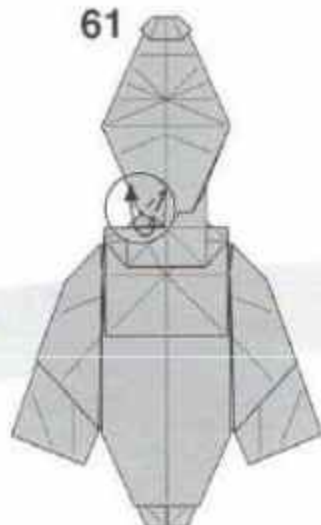

펼쳐 눌러 접어주세요.

69

뒤에 종이를
앞으로
접어주세요.



70

뒤로 넘겨
접어주세요.

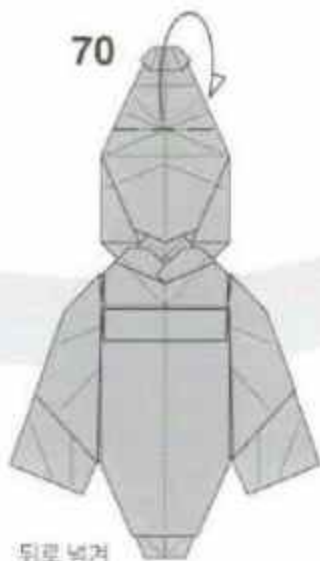

71

가운데로 모아
입체로 접어주세요.

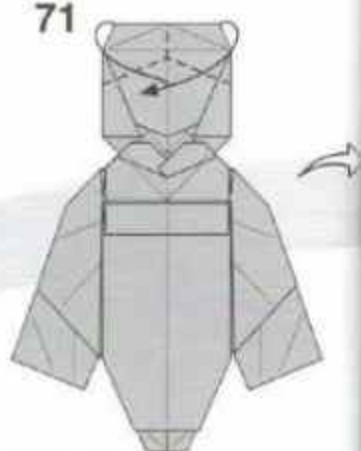

68

앞쪽 종이를
뒤로 접어주세요.



67

선에 맞춰
올려 접어주세요.

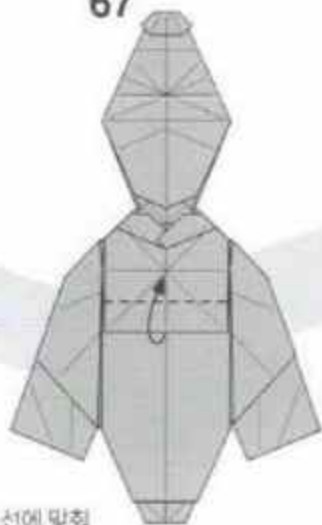

66

뒤어나온 부분을
뒤로 접어주세요.

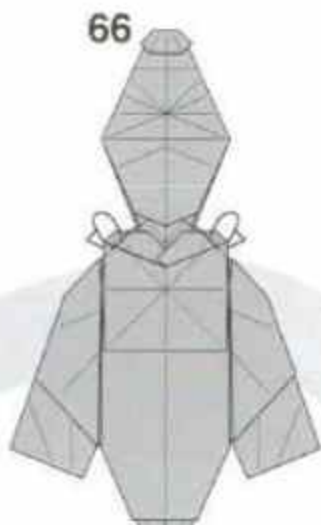

65

가운데로 모아
접어주세요.

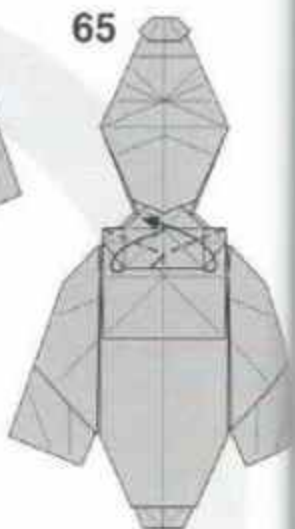

62

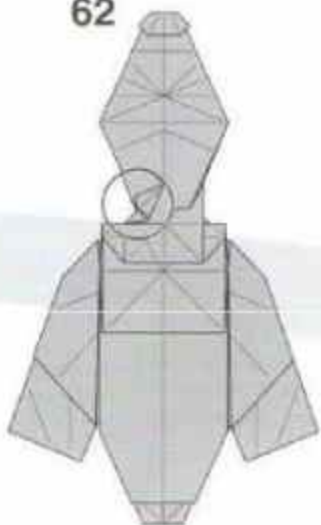

63

○를 잇는
선으로 뒤로 접어주세요.

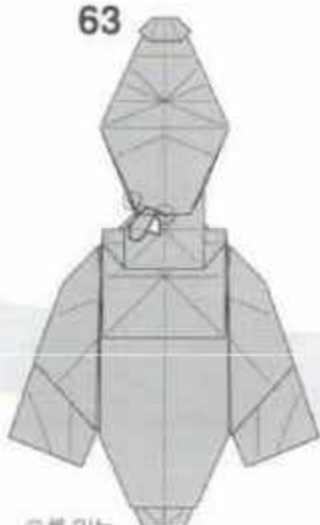

64

반대쪽도 59-63을
반복해주세요.

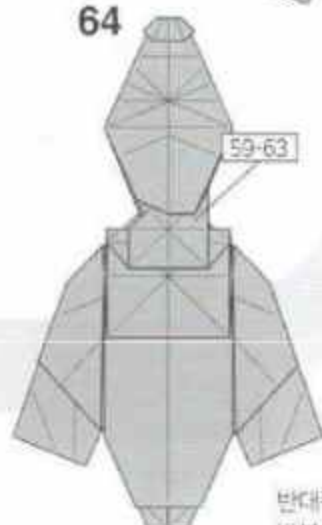

72

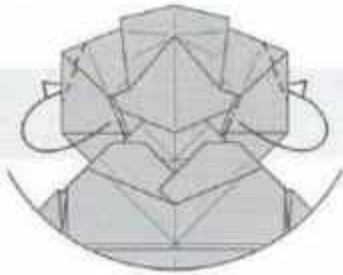

뒤로 넘겨 접어주세요.

73

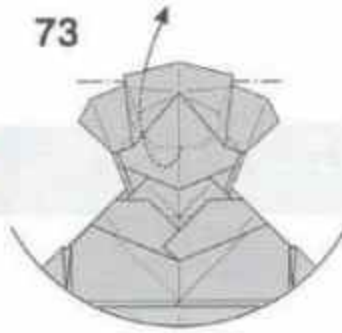

뒤에 종이를
앞으로 접어주세요.

74

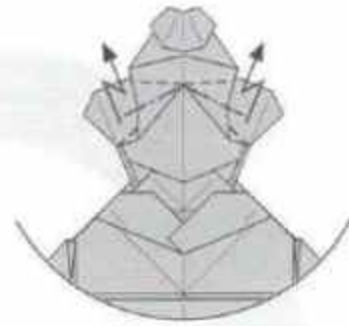

뒤에 종이를
앞으로 접어주세요.

79



완성

75

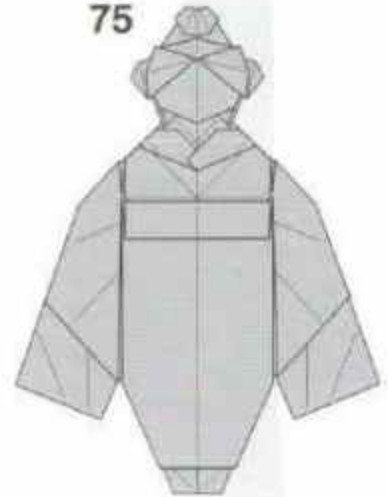

78

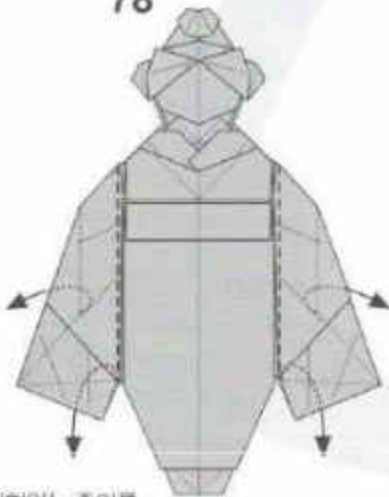

접혀있는 종이를
입체적으로 펴주고
전체적으로 형태를
다듬어주세요.

77

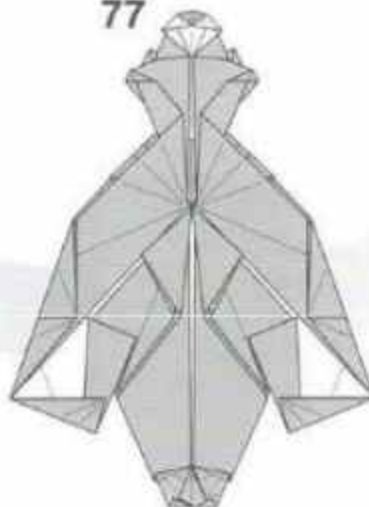

76

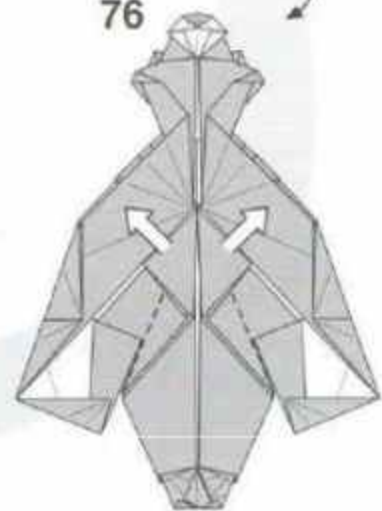

접기선을 이용하여
입체적으로 만들어주세요.

아이스크림

Icecream

- Creator : 정재일(Jeong Jae Il)
- Diagram : 정재일(Jeong Jae Il)
- Size : 15cm x 15cm

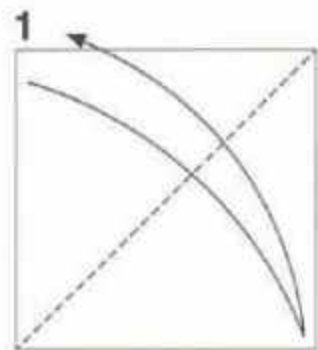
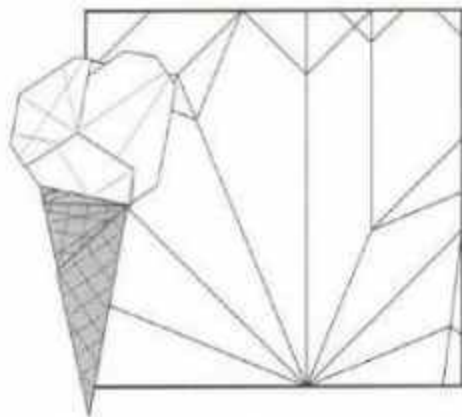

대각선으로 접었다가 펼쳐주세요.

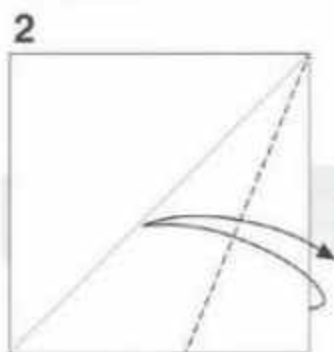

22.5° 선을 내주세요.

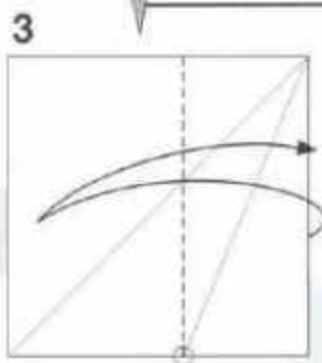

○ 표시를 기준으로 접었다가 펼쳐주세요.

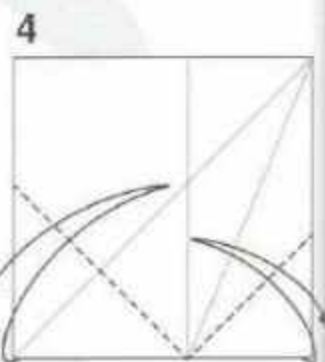

접었다가 펼쳐주세요.

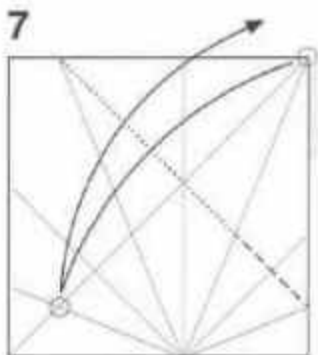

○ 표시를 기준으로 접었다가 펼쳐주세요.

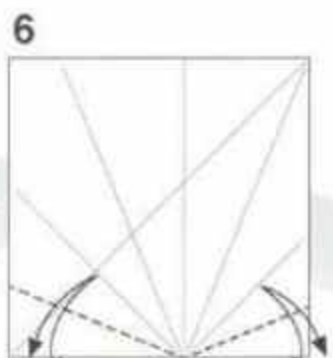

접었다가 펼쳐주세요.

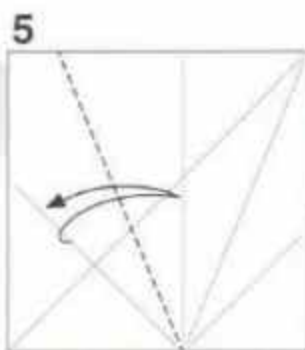

접었다가 펼쳐주세요.

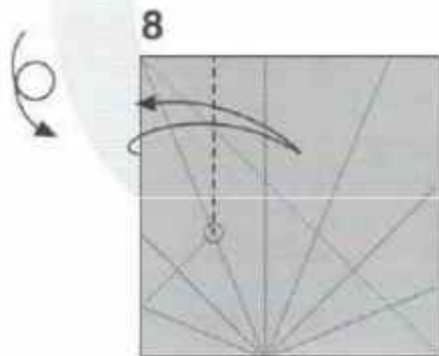

○ 표시를 기준으로 접었다가 펼쳐주세요.

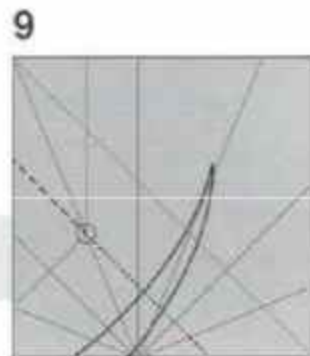

○ 표시를 기준으로 접었다가 펼쳐주세요.

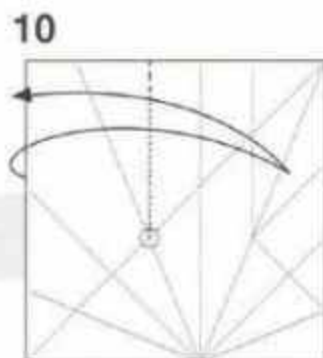

○ 표시를 기준으로 접었다가 펼쳐주세요.

19

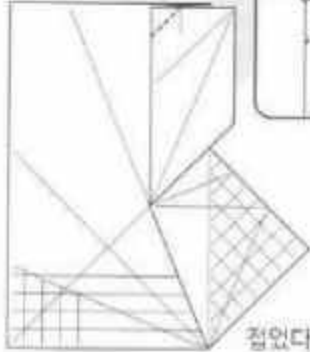

접었다가 펼쳐주세요.

20

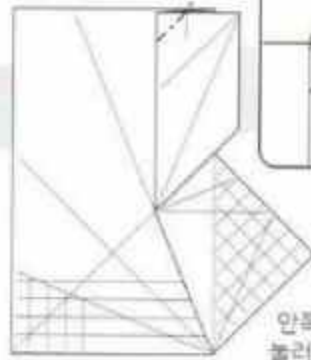

안쪽으로 펼쳐
눌러접어주세요.

21

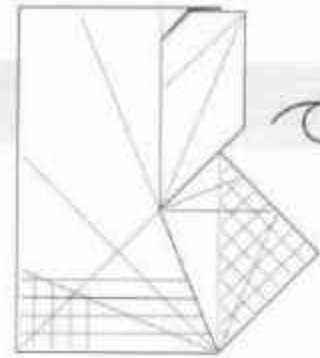

18

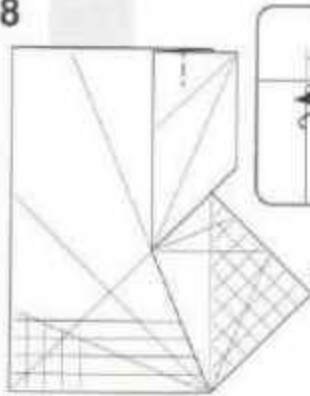

o 표시를 기준으로
접었다가 펼쳐주세요.

16

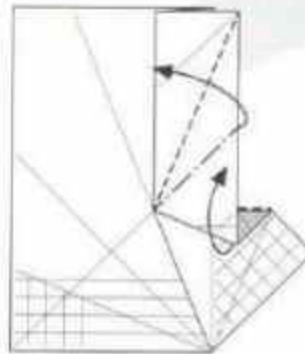

당기면서 접어주세요.

15

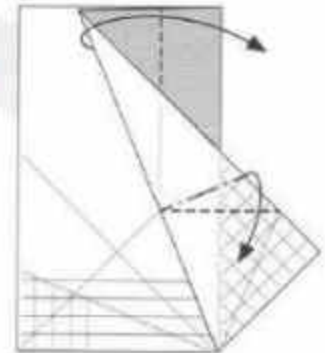

당기면서 접어주세요.

17

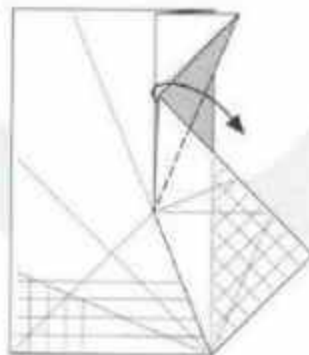

14

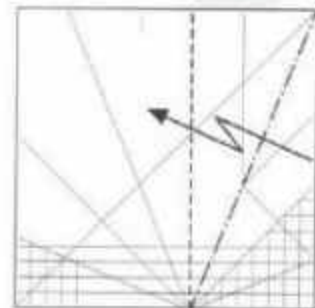

계단접기 해주세요.

11

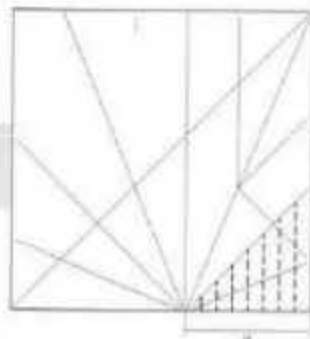

양면 선을 맞추세요.

12

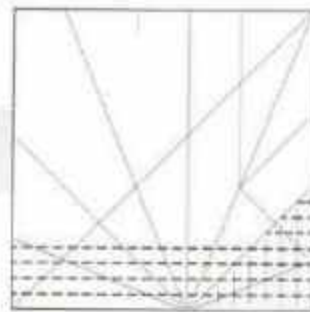

양면 선을 맞추세요.

13

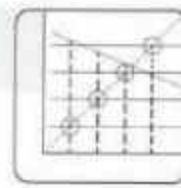

o 표시를 기준으로
접었다가 펼쳐주세요.

22

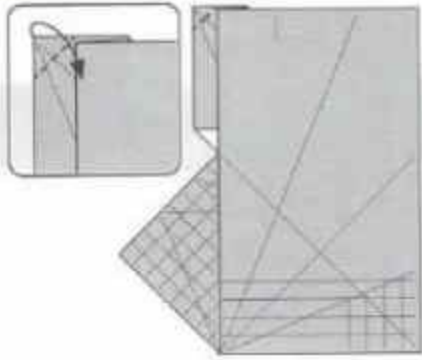

23

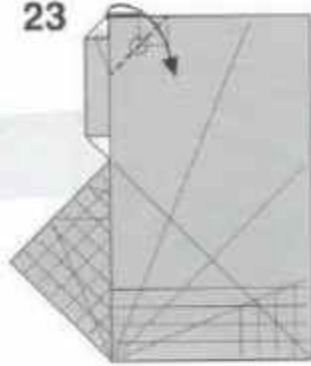

24

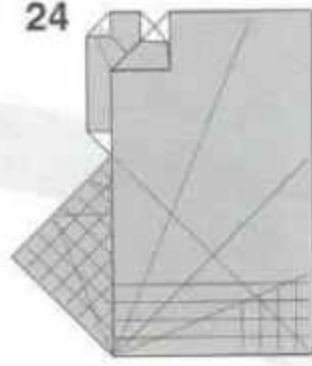

28

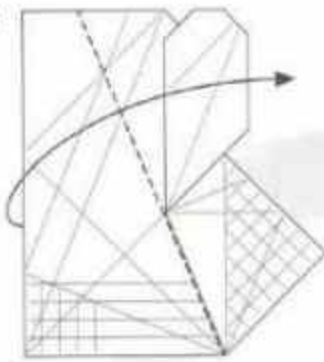

27

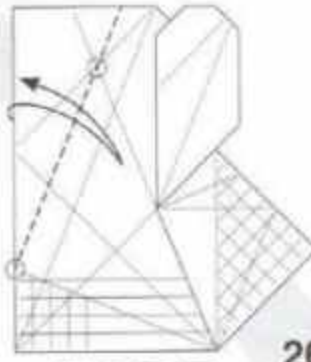

○ 표시를 기준으로 접었다가 펼쳐주세요.

25

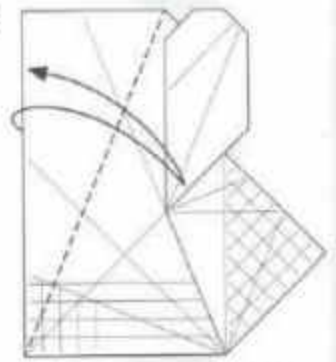

접었다가 펼쳐주세요.

29



접었다가 펼쳐주세요.

26

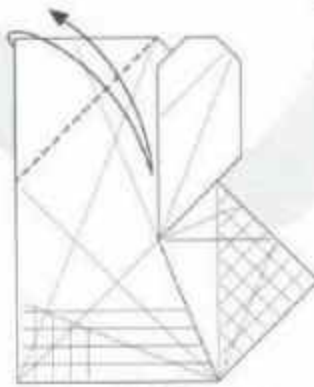

접었다가 펼쳐주세요.

30



안쪽으로 펼쳐
붙여주세요.

31

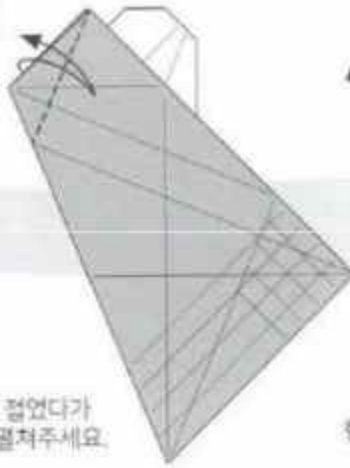

붙였다가
펼쳐주세요.

32



어두운 부분을
함몰집기 해주세요.
(Open Sink)

40

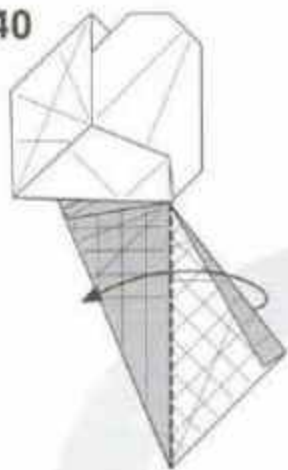

41



42

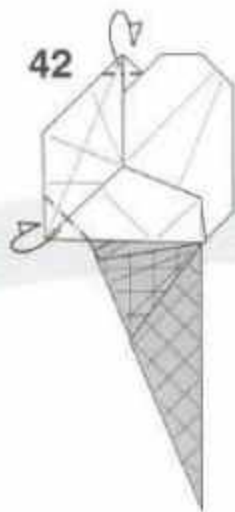

43



단아선

39



o 표시를
기준으로
접어주세요.

38



당기면서
접어주세요.

37

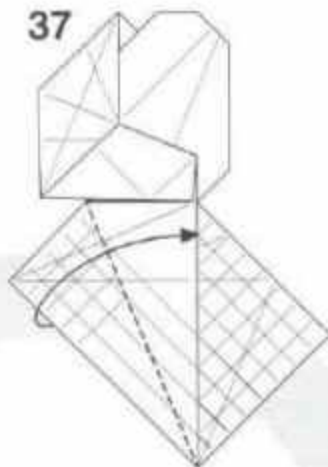

36

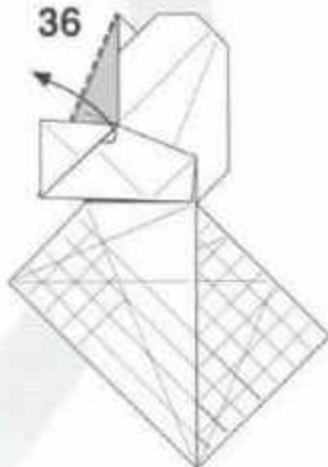

화살표 방향으로 접어주세요.

34

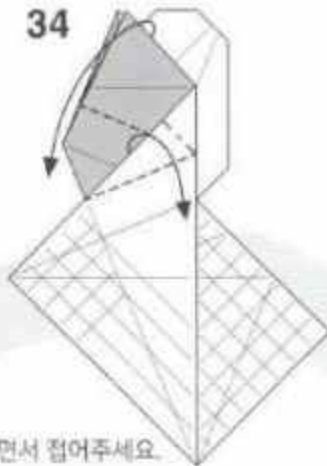

당기면서 접어주세요.

35

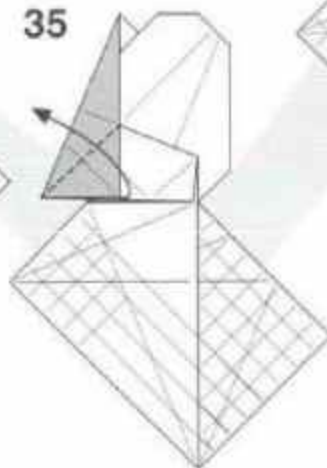

33

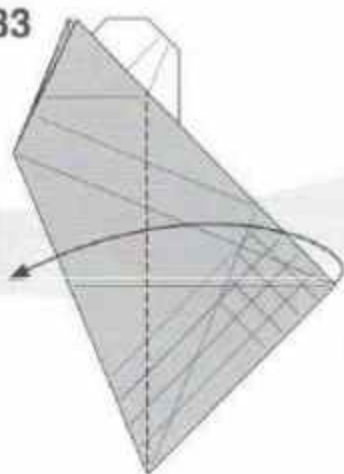

수박조각

Watermelon Piece

- Creator : 김진우(Kim Jin Woo)
- Diagram : 박종우(Park Jong Woo)
- Size : 15cm x 15cm

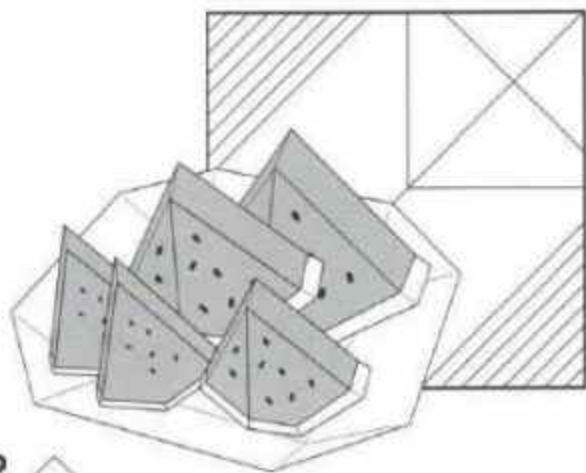

Piece - A

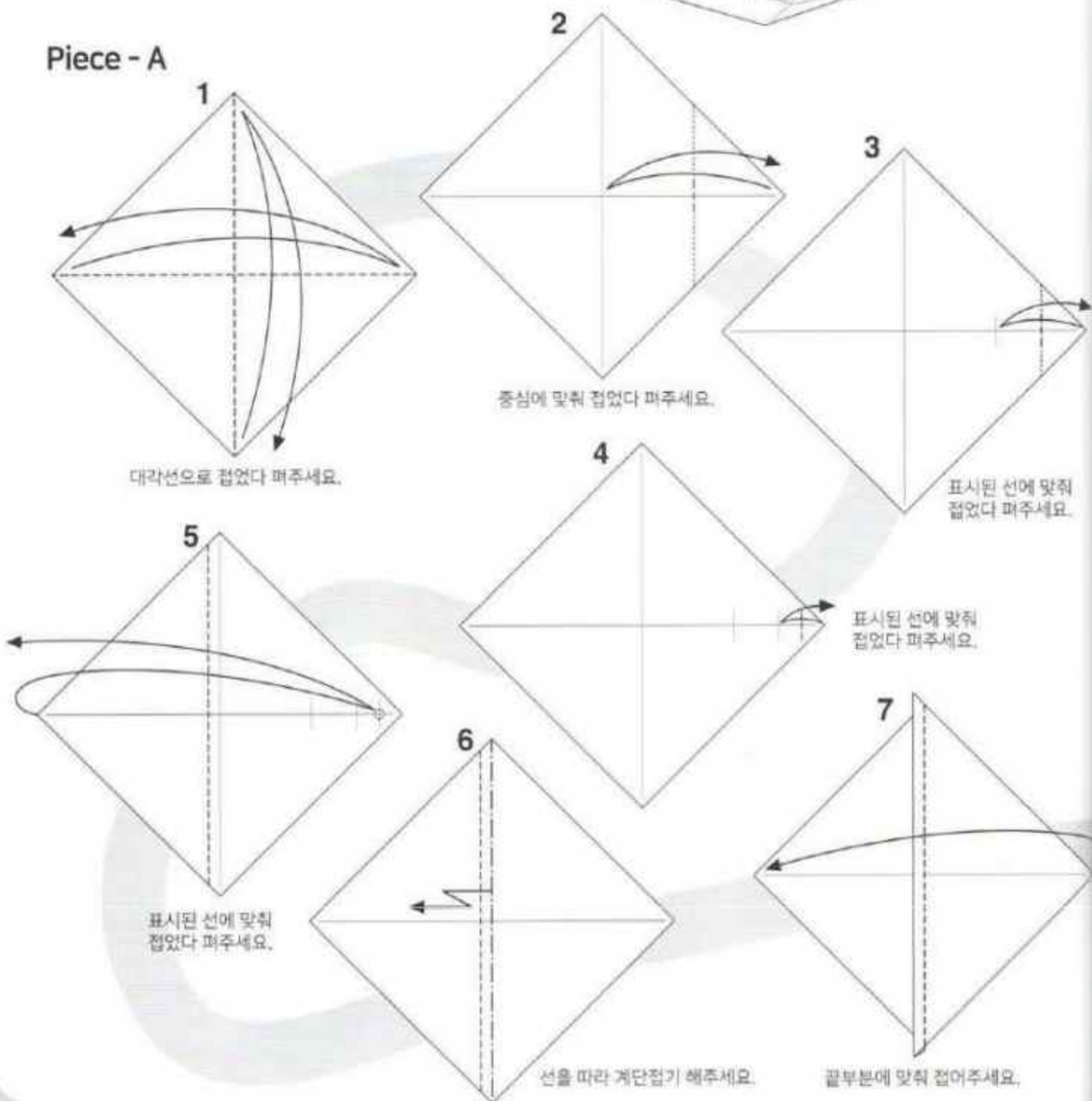

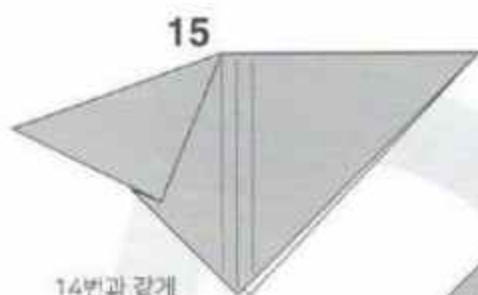

15

14번과 같게
다시 펼쳐주세요.

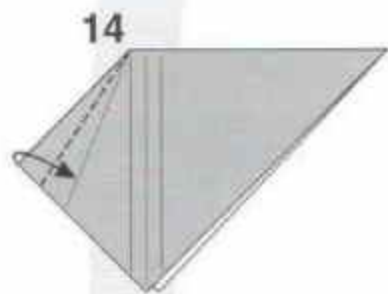

14

선에 맞춰
접어주세요.

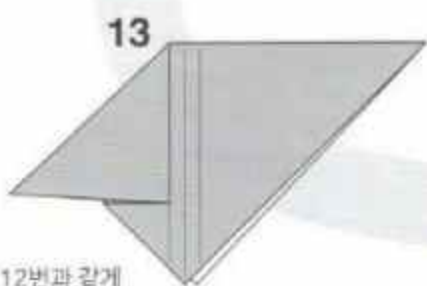

13

12번과 같게
다시 펼쳐주세요.

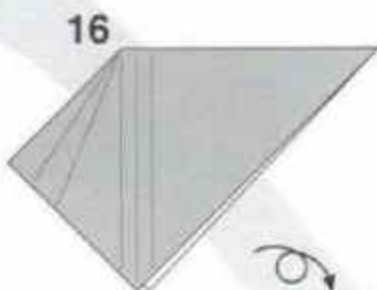

16

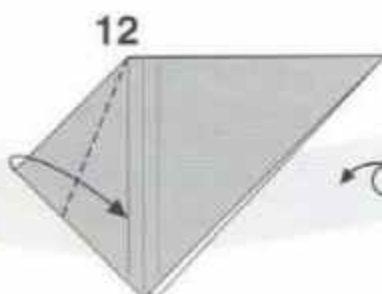

12

선에 맞춰
접어주세요.

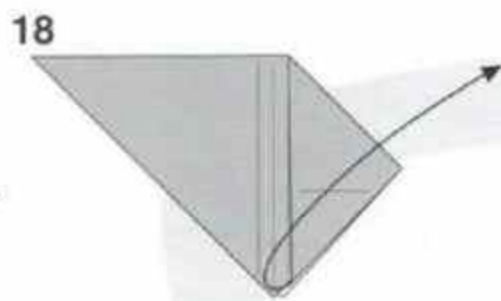

18

다시 펼쳐주세요.

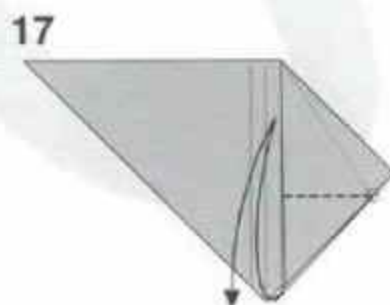

17

14의 선에 맞춰
접었다 펴주세요.

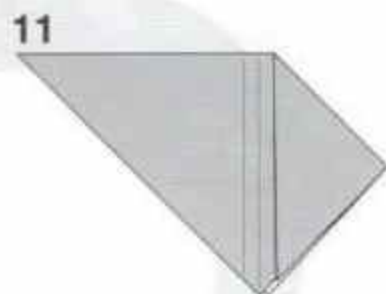

11



8

7번과 같게
다시 펼쳐주세요.

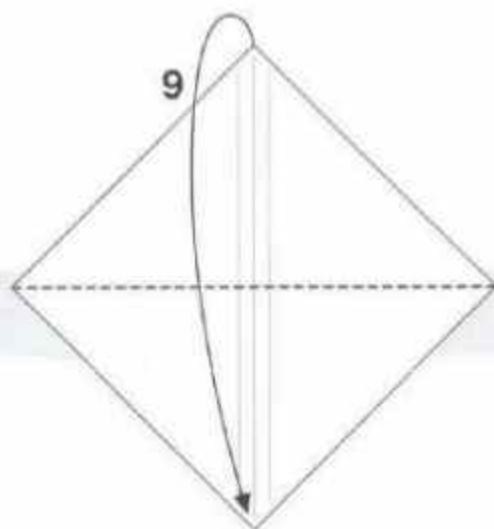

9



10

선에 맞춰
접어 내리세요.

19

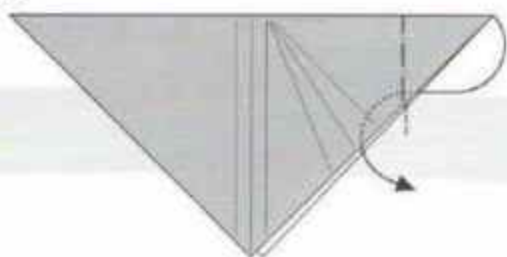

안쪽으로 펼쳐 눌러 접어주세요.

20

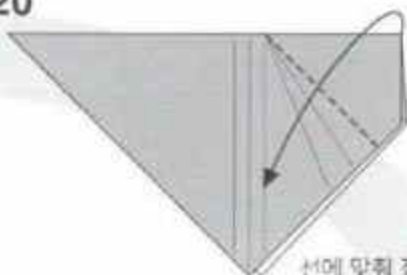

선에 맞춰 접어 내리세요.

24

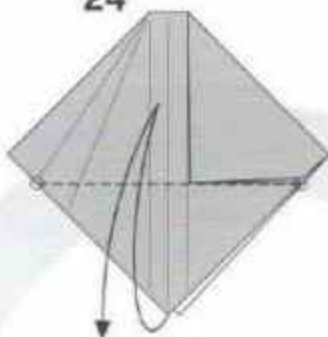

표시된 부분에 맞춰 접었다 펴주세요.

23

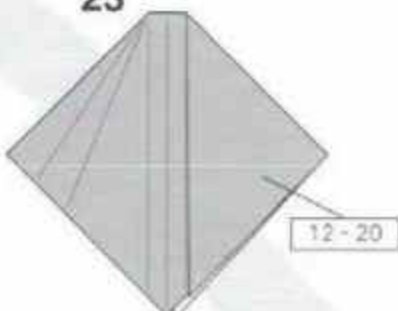

반대쪽도 12-20을 반복해주세요.

21

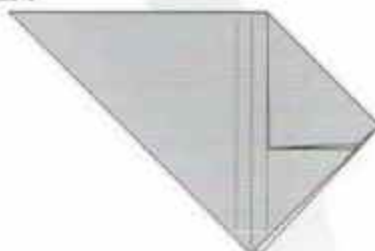

25

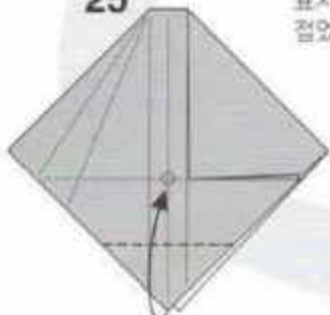

표시된 부분에 맞춰 접어주세요.

26

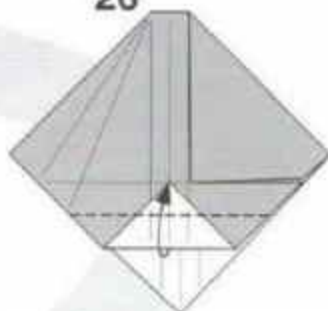

표시된 부분에 맞춰 접어 올리세요.

22



선에 맞춰 접어 내리세요.

27

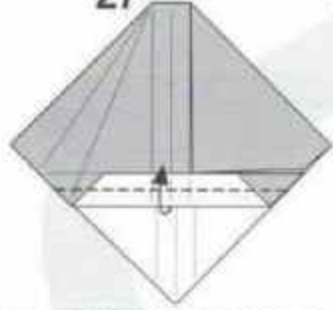

표시된 부분에 맞춰 접어 올리세요.

29

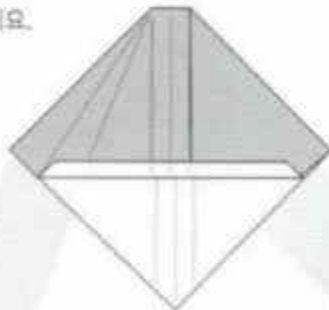

28

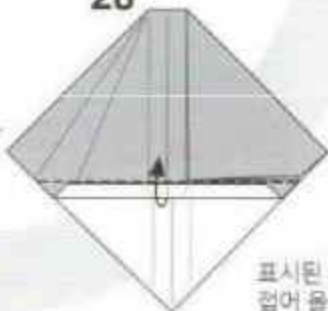

표시된 부분에 맞춰 접어 올리세요.

30

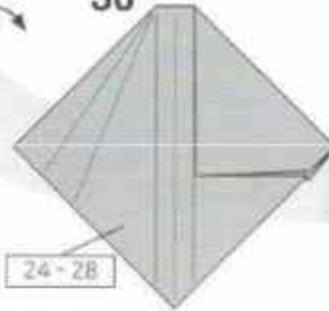

반대쪽도 24-28을 반복해주세요.

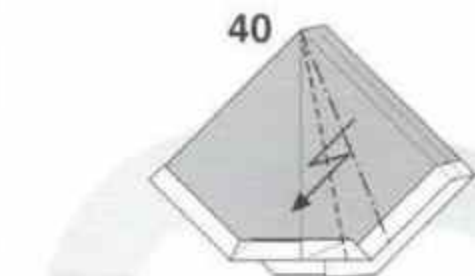

31 가운데 선을 따라 입체로 만들어주세요.

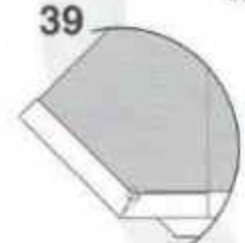

32 계단접기 해주세요.

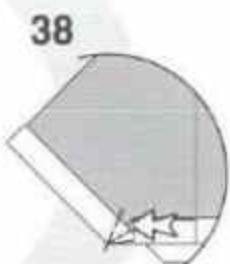

33 표시된 부분에 맞춰 접었다 펴주세요.

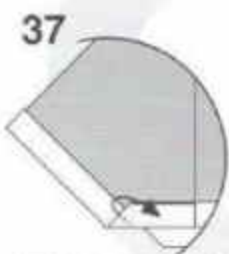

34 32번과 같게 다시 펼쳐주세요.

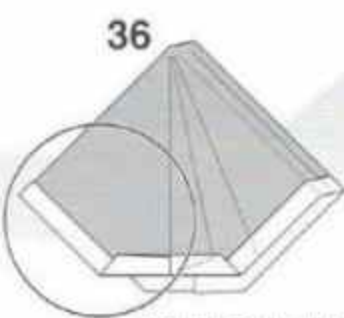

35 안쪽에 접혀있는 종이를 빼주세요.

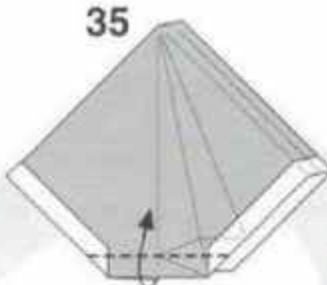

36 안쪽으로 접어주세요.



37 펼쳐 눌러 접어주세요.

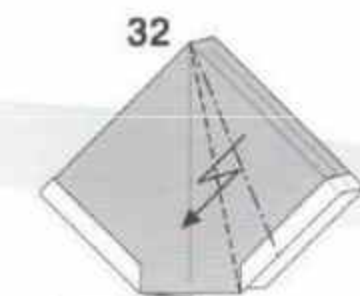

38 안쪽의 종이를 반대로 접어주세요.



39 반대쪽도 32-42를 반복해주세요.



40 계단접기 해주세요.



41 완성



42 안쪽의 종이를 반대로 접어주세요.

43



32-42

44

44 완성

Piece - B

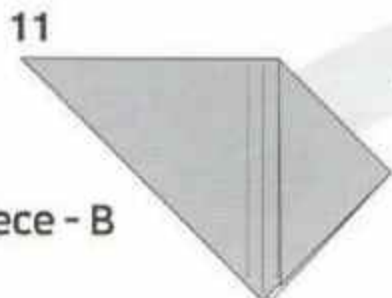

Piece-A 11번에서부터 시작합니다.

12

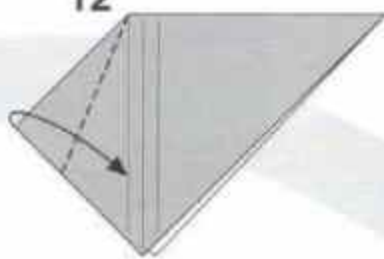

뒤집어서 선에 맞춰 접어주세요.

13

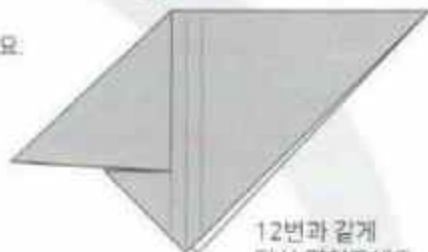

12번과 같게 다시 펼쳐주세요.

15

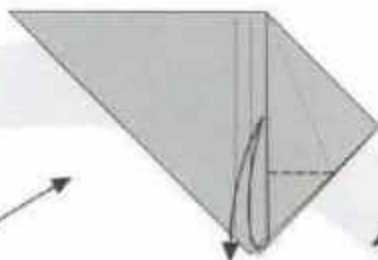

12의 선에 맞춰 접었다 펴주세요.

16



다시 펼쳐주세요.

14



뒤집어주세요.

17



안쪽으로 펼쳐 눌러 접어주세요.

18

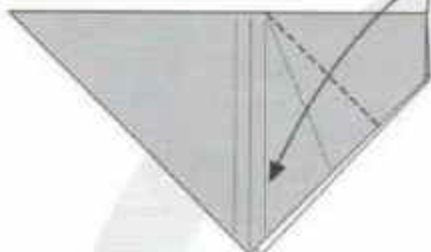

선에 맞춰 접어 내리세요.

20

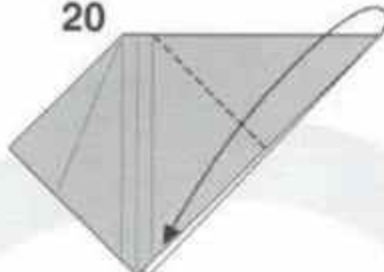

선에 맞춰 접어 내리세요.

19

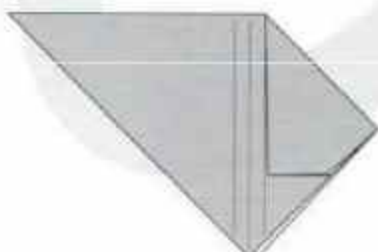

뒤집어주세요.

21

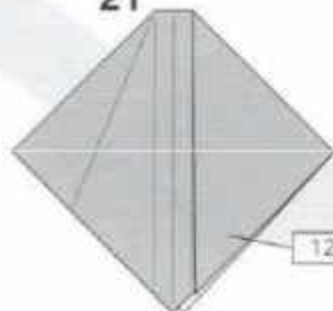

12-18

반대쪽도 12-18을 반복해주세요.

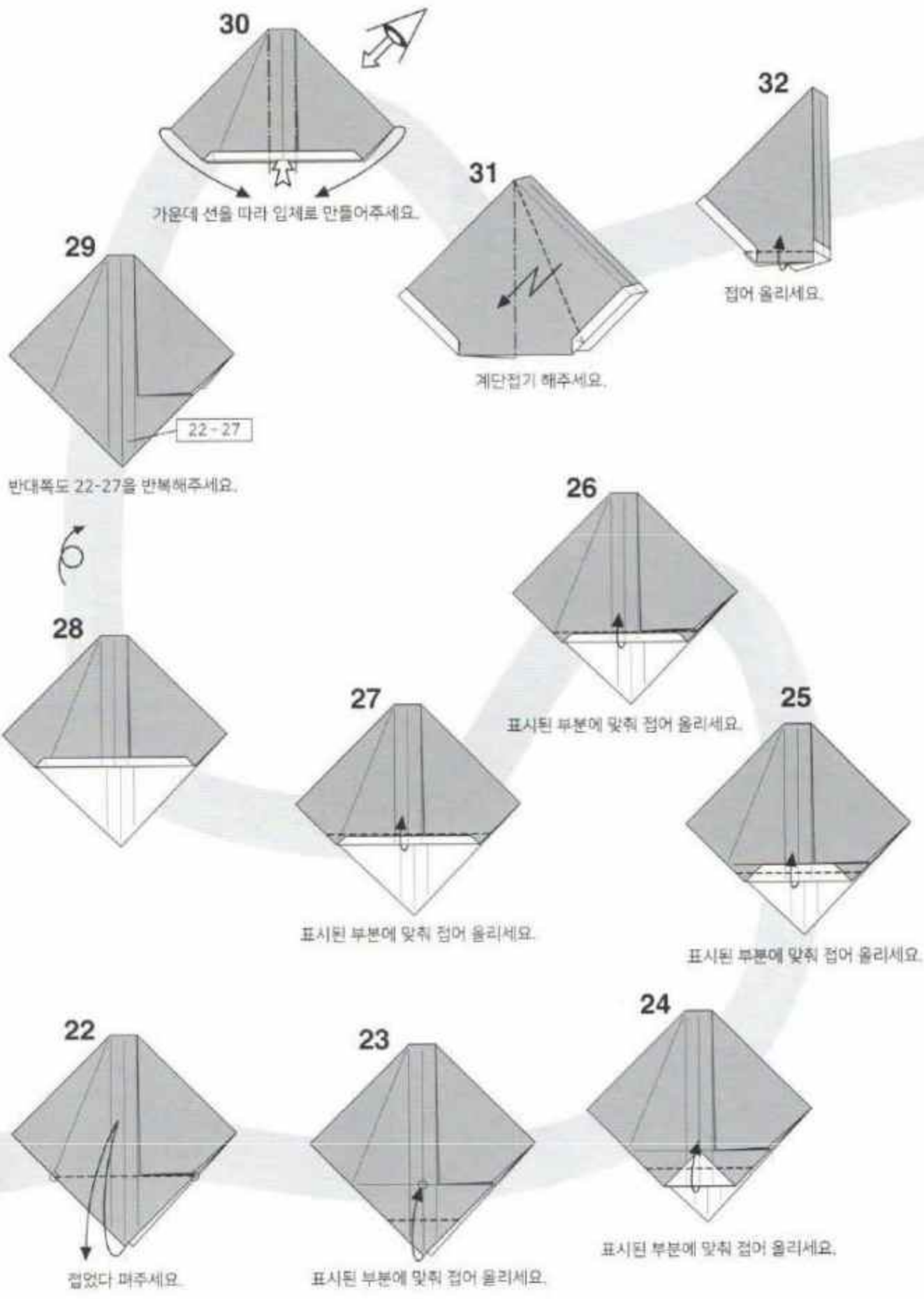

30

가운데 선을 따라 입체로 만들어주세요.

32

접어 올리세요.

29

22-27

반대쪽도 22-27을 반복해주세요.

31

계단접기 해주세요.

26

표시된 부분에 맞춰 접어 올리세요.

28

27

표시된 부분에 맞춰 접어 올리세요.

25

표시된 부분에 맞춰 접어 올리세요.

22

겹었다 파주세요.

23

표시된 부분에 맞춰 접어 올리세요.

24

표시된 부분에 맞춰 접어 올리세요.

33



뒷쪽의 종이를 앞으로 꺼내주세요.

34



안쪽에 접혀있는 종이를 펴주세요.

35



표시된 부분이 맞닿도록 해주세요.

36



반대쪽도 31-34를 반복해주세요.

37

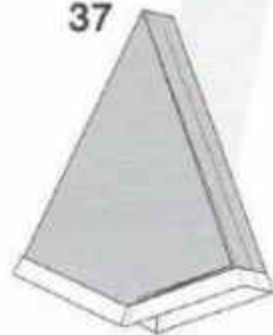

완성

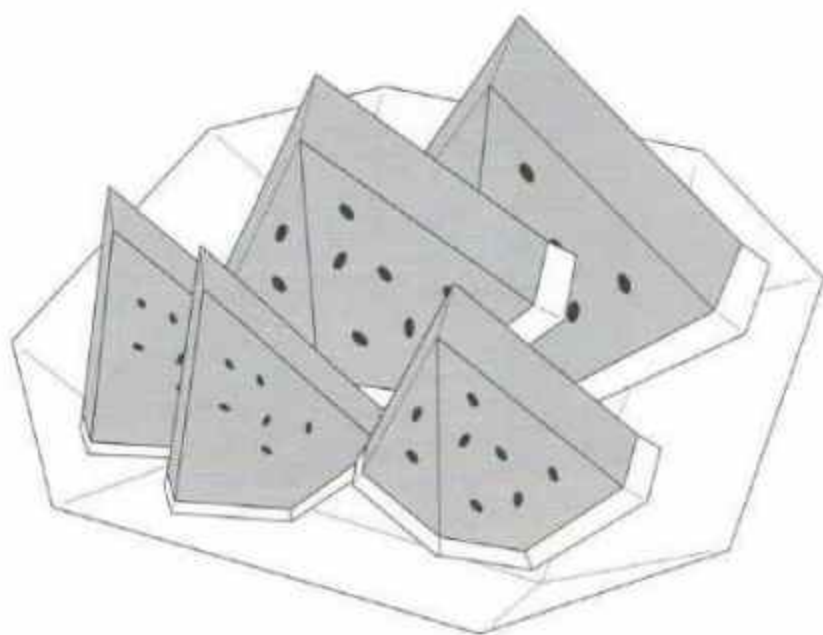

버니

Bunny

- Creator : 박종우(Park Jong Woo)
- Diagram : 박종우(Park Jong Woo)
- Size : 25cm x 25cm

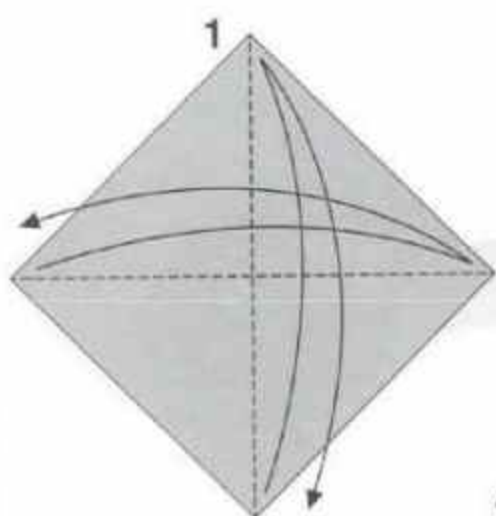
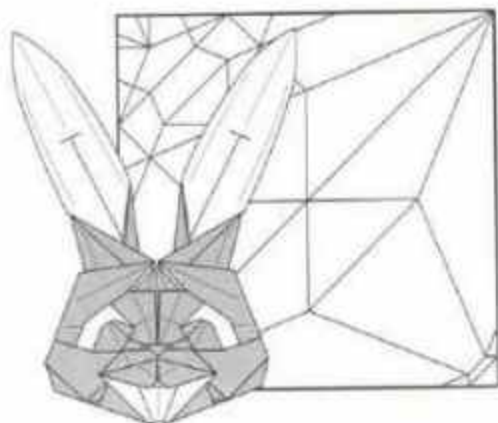

대각선으로 접었다 펴주세요.

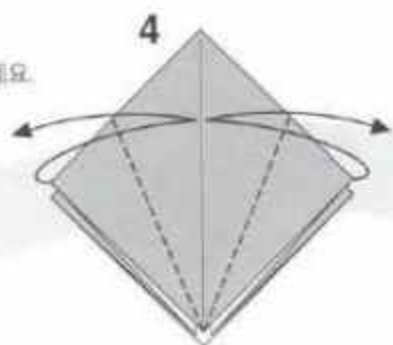
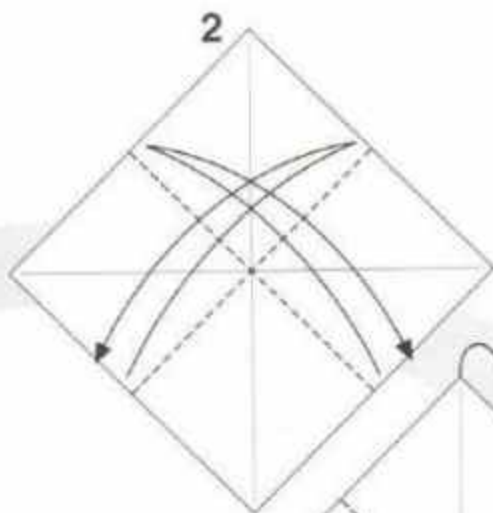

중심선에 맞춰 접었다 펴주세요.

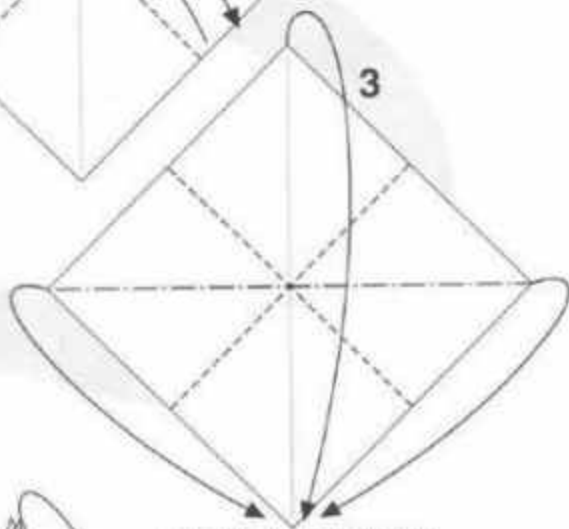

사각주머니 접기를 해주세요.

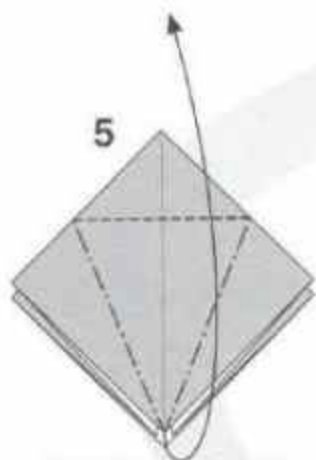

선을 따라 접어 돌리세요.

4-5

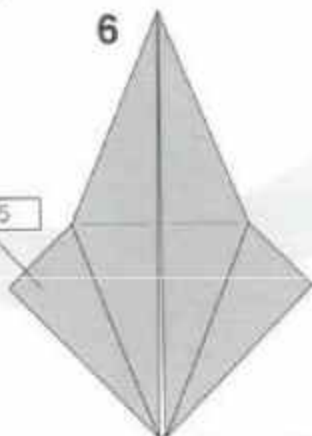

반대쪽도 4-5를 반복해주세요.

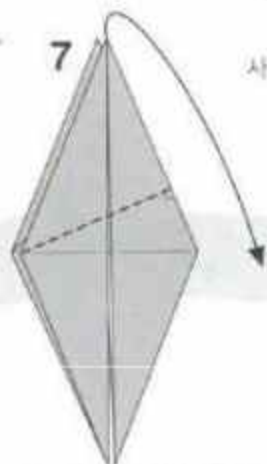

표시된 선을 따라 접어주세요.

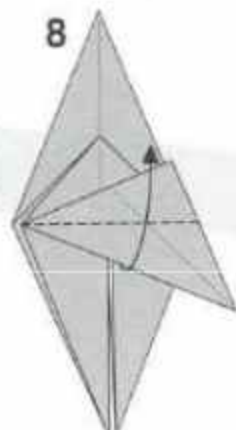

표시된 선을 따라 접어주세요.



선을 따라 모아 접어주세요.



앞면 평면이 될 때까지 돌려주세요.

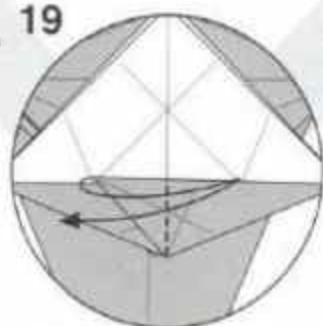

반대쪽으로 접었다 펴주세요.

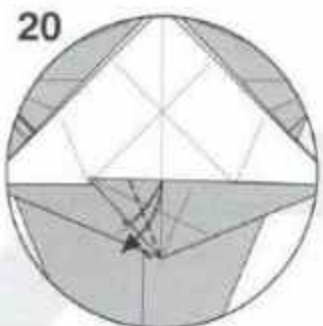

선에 맞춰 접었다 펴주세요.



선에 맞춰 접었다 펴주세요.

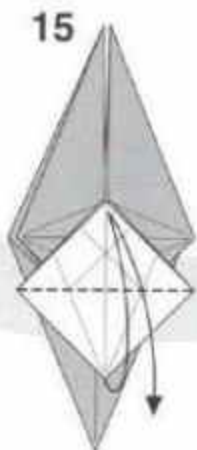

반으로 접었다 펴주세요.

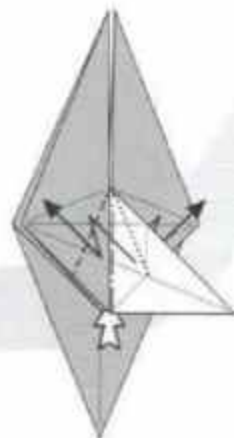

한 부분을 펼쳐 분리해주세요.

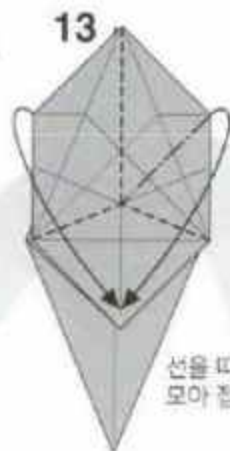

선을 따라 모아 접어주세요.

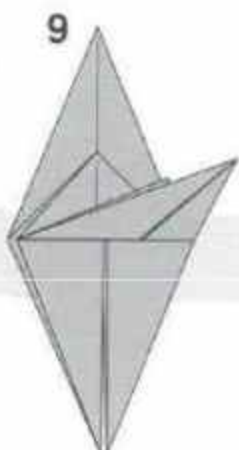

다시 펼쳐주세요.

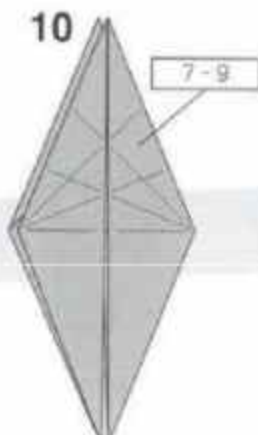

반대쪽도 7-9를 반복해주세요.

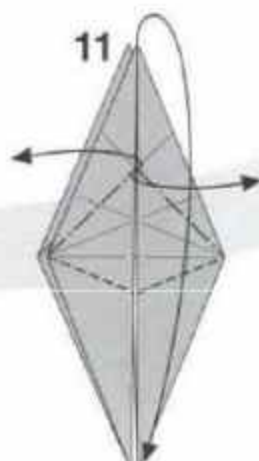

선을 따라 펼쳐 분리 접어주세요.



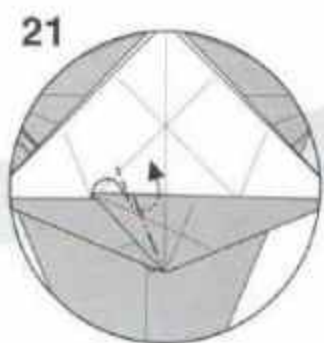

안쪽으로 펼쳐 놓고 접어주세요.

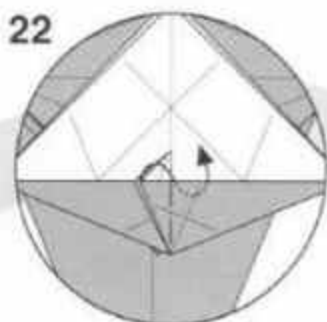

안쪽으로 펼쳐 놓고 접어주세요.

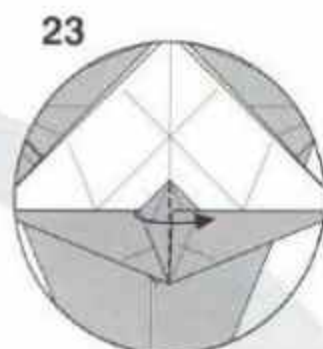

반대쪽으로 접어주세요.

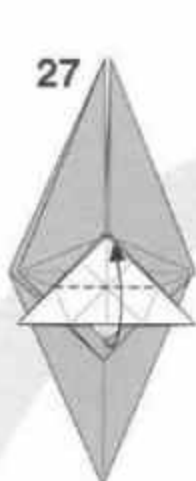

앞부분의 장편 접어 줄기세요.



뒷쪽으로 접어주세요.

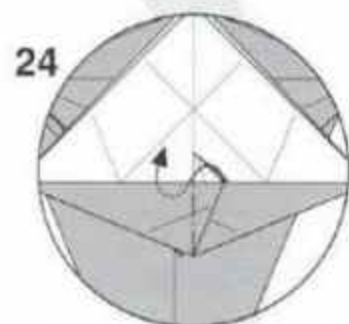

안쪽으로 펼쳐 놓기 접어주세요.

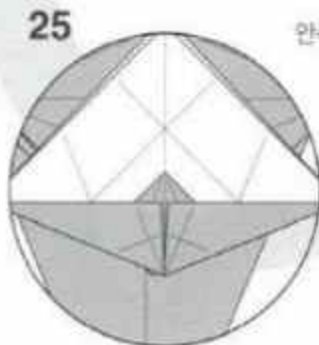

다시 전체를 봐주세요.



앞부분의 장편 접어주세요.

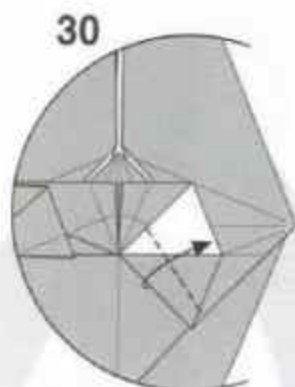

표시된 선에 맞춰 접어주세요.

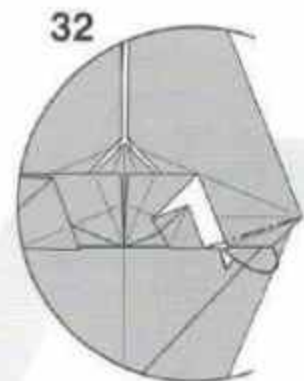

뒷쪽으로 접어주세요.

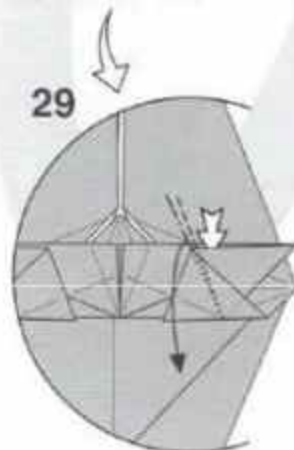

펼쳐 놓기 접어주세요.

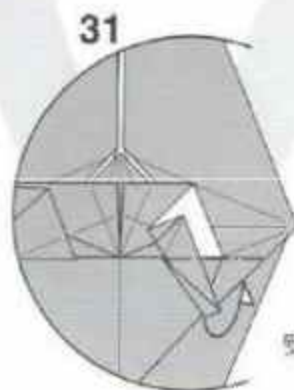

뒷쪽으로 접어주세요.

41



끝부분에 맞춰 접어 내리세요.

43

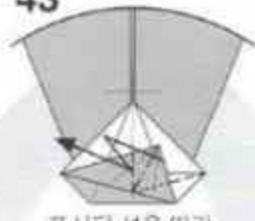

표시된 선을 따라 반대쪽도 접어주세요.

40



선을 따라 펼쳐 활공 면이 넓어주세요.

42

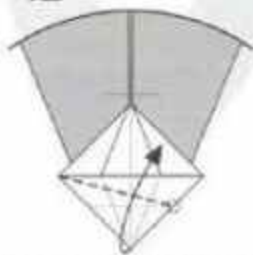

왼부분에 맞춰 접어 올리세요.

44

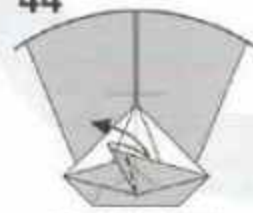

중심선에 맞춰서 접었다 펴주세요.

39

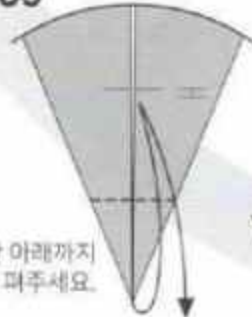

표시된 선보다 약간 아래까지 접었다 펴주세요.

38

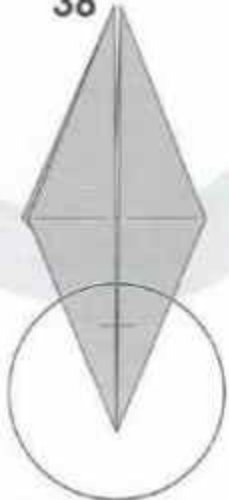

아래 부분을 펴주세요.

37



가운데에 맞춰 접었다 펴주세요.

33

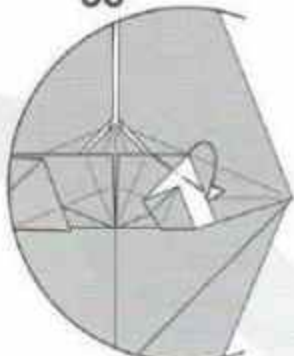

왼쪽으로 접어주세요.

34

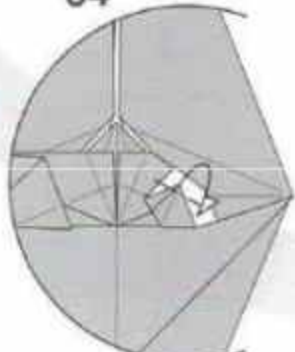

왼쪽으로 접어주세요.

35

29-34

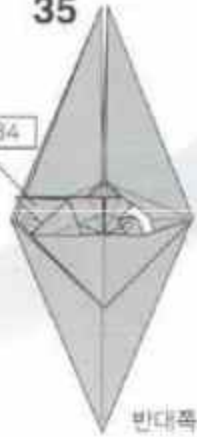

반대쪽도 29-34를 반복해주세요.

36



뒤집어주세요.

47



선을 따라 다시 접어주세요.

46

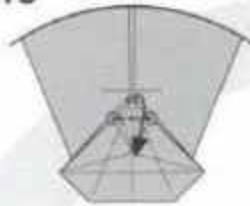

표시된 부분에 맞춰서 접어주세요.

48



안쪽으로 펼쳐 눌러 접어주세요.

45



41번이 되도록 다시 펼쳐주세요.

50

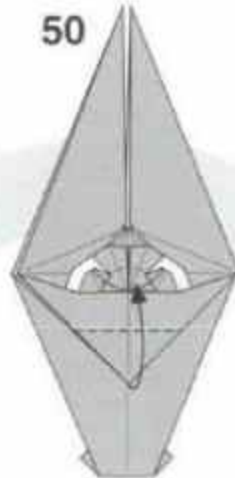

표시된 선을 따라 접어 올리세요.

49



다시 전체를 비주세요.

51

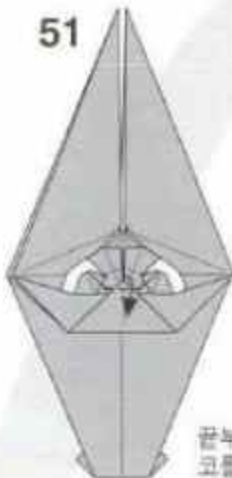

앞부분을 살짝 접어
뒤쪽만 들어주세요.

54



뒤쪽으로 접어주세요.

52

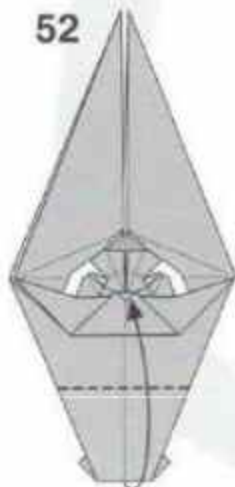

표시된 선을 따라 접어 올리세요.

53

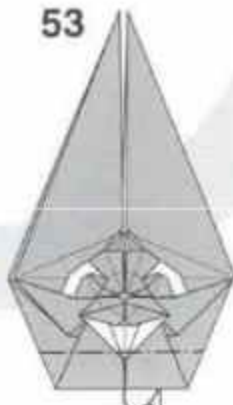

뒤쪽으로 접어주세요.

55

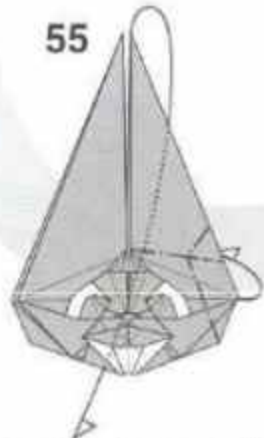

표시된 선을 따라 접어 내리세요.

62

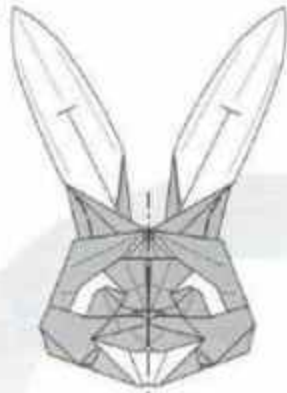

전체적인 모양을 다듬어주세요.

63

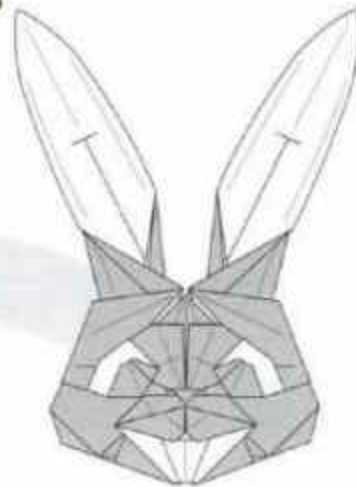

완성

61

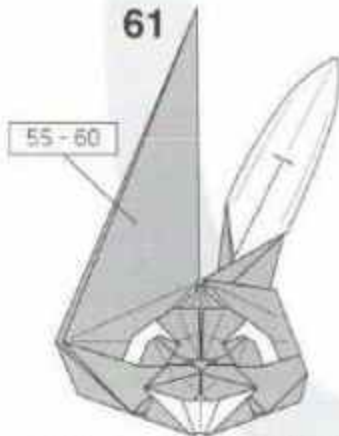

반대쪽도 55-60을 반복해주세요.

59



귀의 모양을 다듬어주세요.

60



뒷쪽으로 접어주세요.

56

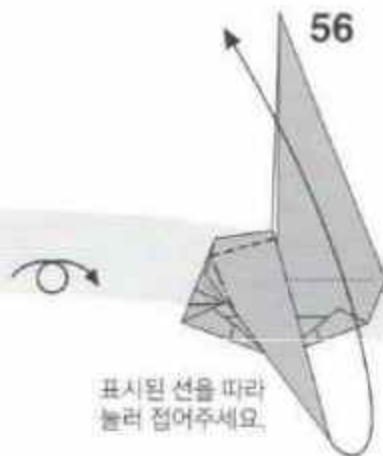

표시된 선을 따라
눌러 접어주세요.

57



안쪽으로 펼쳐 눌러 접어주세요.

안쪽의 증이증을
한 겹만 꺼내서 접어주세요.

토끼

RABBIT

- Creator : 유태용(Yoo Tae Yong)
- Diagram : 유태용(Yoo Tae Yong)
- Size : 20cm x 20cm

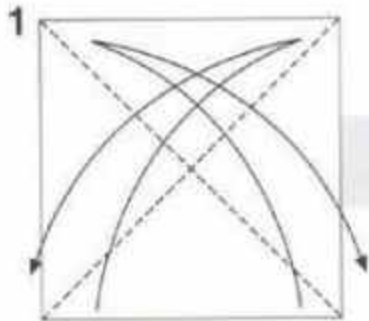
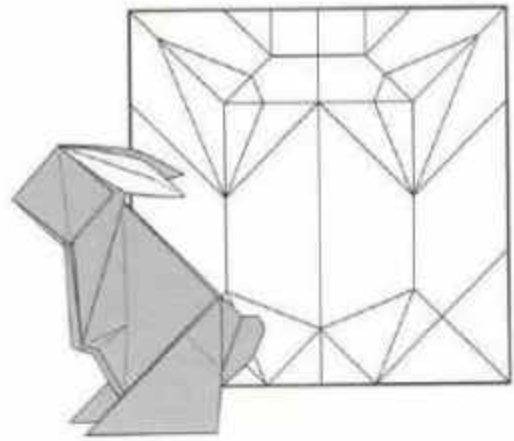

대각선으로
접었다 펴주세요.

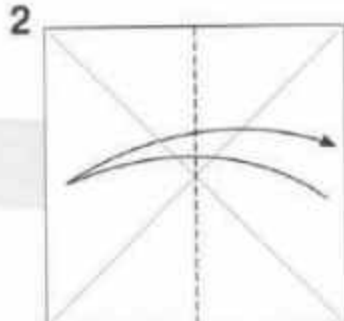

반으로 접었다 펴주세요.

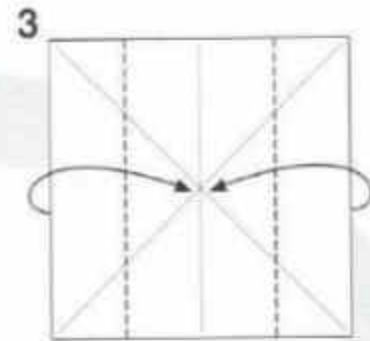

중심에 맞춰 접어주세요.

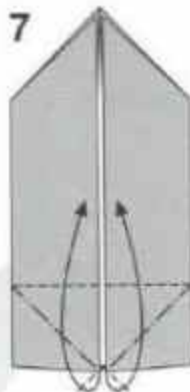

위로 펼쳐 눌러
접어주세요.

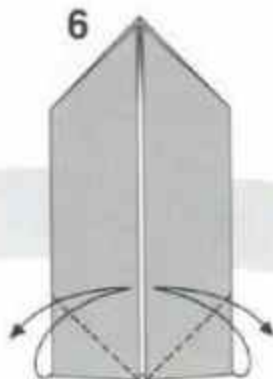

중심에 맞춰
접었다 펴주세요.

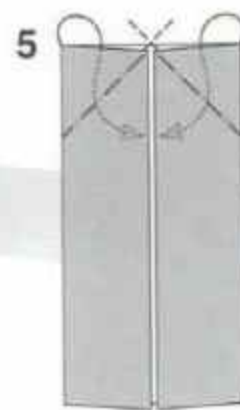

안쪽으로 펼쳐 눌러
접어주세요.

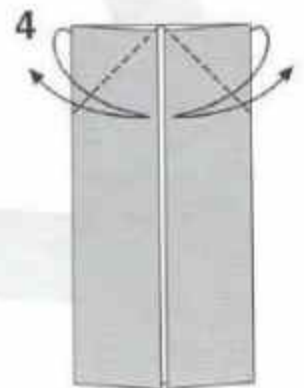

중심에 맞춰
접었다 펴주세요.



선에 맞춰
뒤로 접어주세요.



종이를 당겨주세요.



펼쳐 눌러 접어주세요.

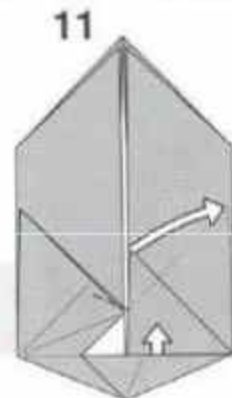

종이를 당겨주세요.

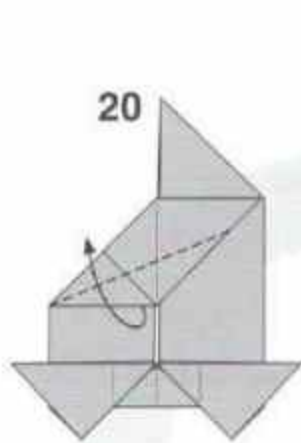

위로 접어주세요.

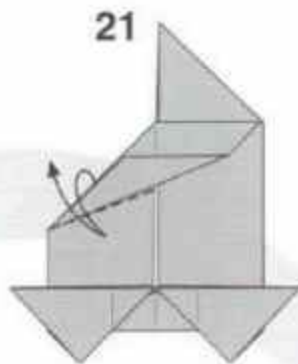

접었다 펴주세요.

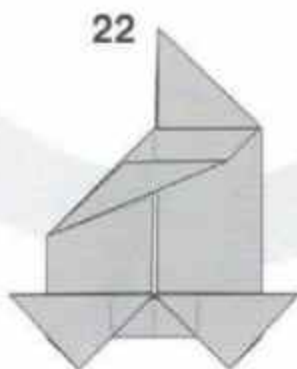

19번으로 돌아가주세요.

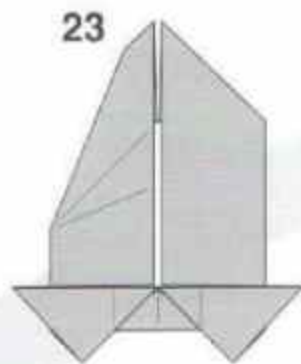

반대쪽도 19-22를 반복해주세요.

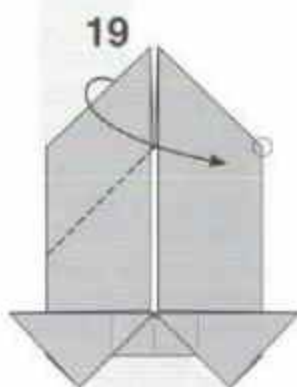

○에 맞춰 접어주세요.

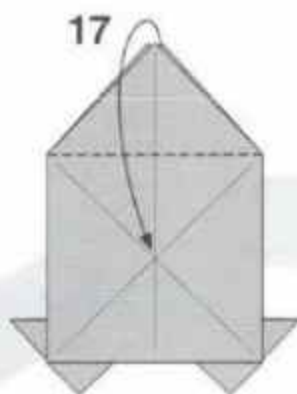

아래로 접어주세요.

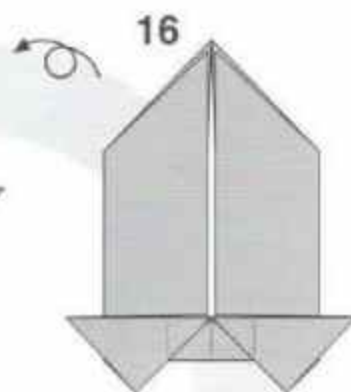

안쪽으로 펼쳐 불러 접어주세요.



위로 접어주세요.



아래로 접어주세요.

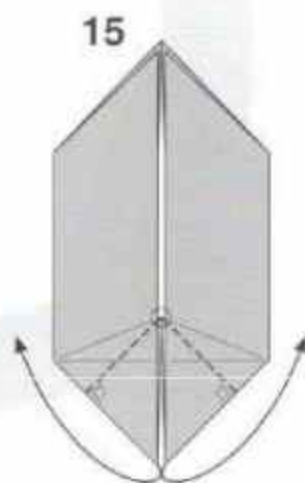

○부분에서 반과 직각이 되도록 접어주세요.

24

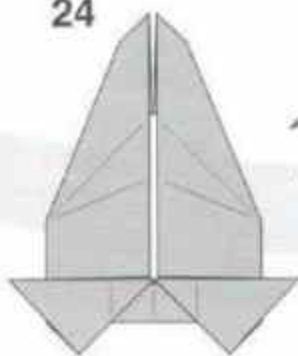

25

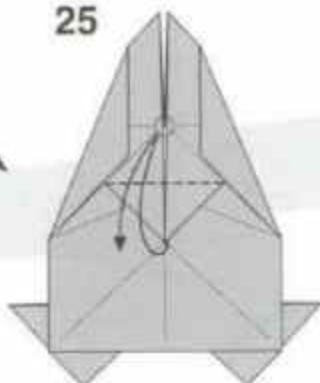

○에 맞춰 접었다
펴주세요.

26

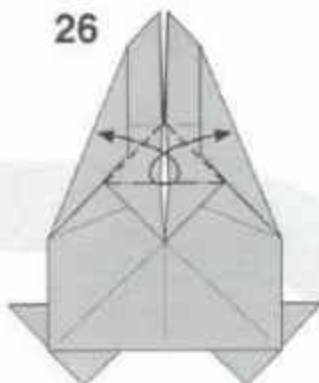

양쪽으로 펼쳐
눌러 접어주세요.

27

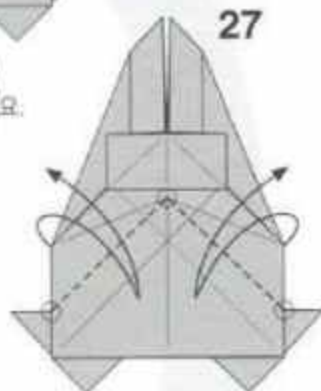

○를 잇는 선으로
접었다 펴주세요.

30

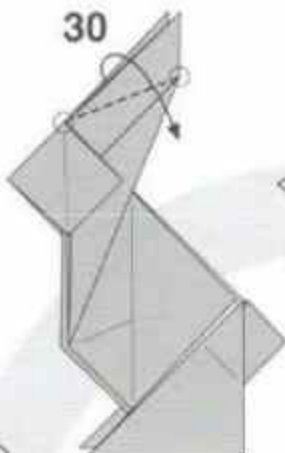

○를 잇는 선으로
접었다 펴주세요.

29

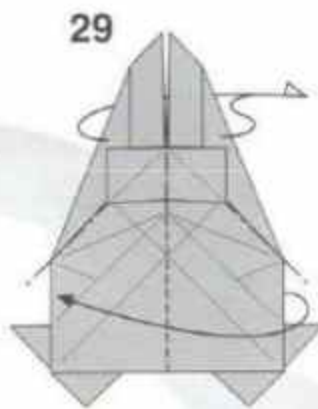

꼭부분을 뒤집는 동시에
앞으로 접어주세요.

28

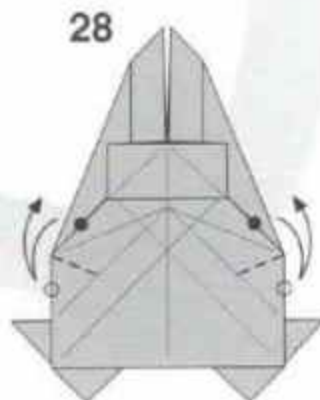

○과 ●가 만나도록
접었다 펴주세요.

31



뒤로 넘겨
접어주세요.

33

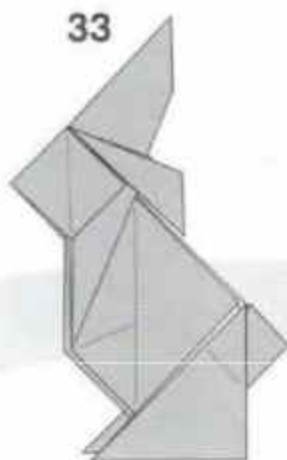

반대쪽도 30-32를
반복해주세요.

32

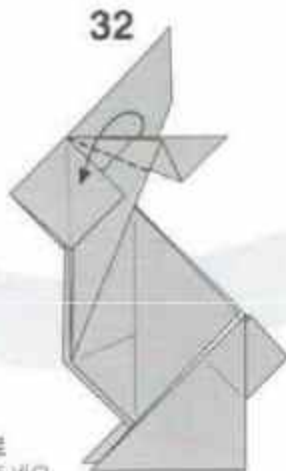

아래로
접어주세요.

34

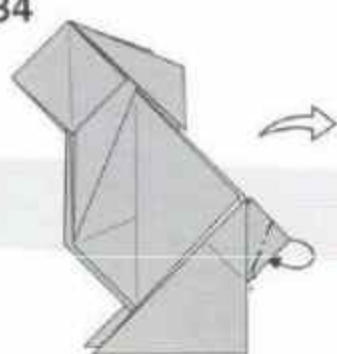

안쪽으로 접어주세요.

39

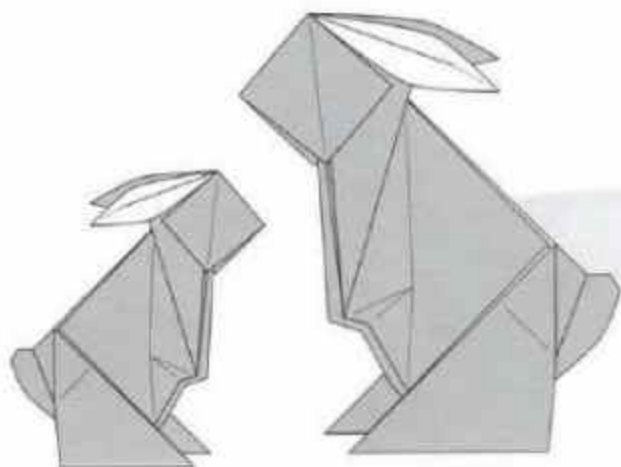

완성

38

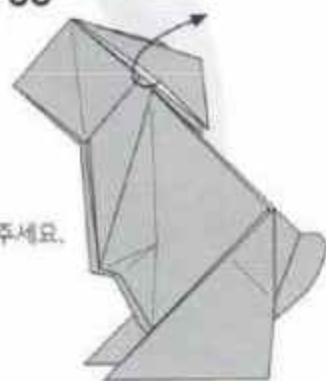

귀를 펼쳐주세요.

37

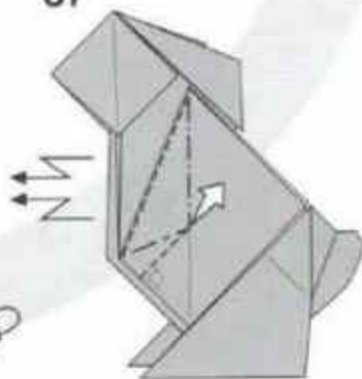

양쪽 다 접기선을 이용하여 토끼의 발을 만들어주세요.

36

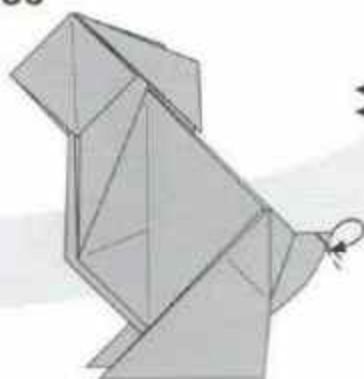

꼬리 끝부분을 조금 안쪽으로 접어주세요.

35

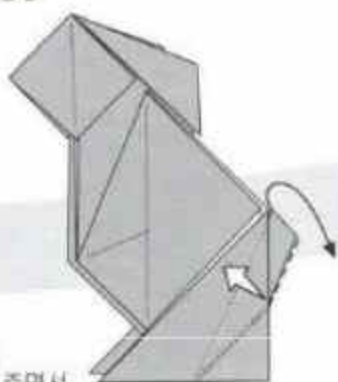

밖으로 뒤집어 주면서 몸통을 입체로 만들어주세요.

피라루크

Pirarucu

- Creator : 박종우(Park Jong Woo)
- Diagram : 박종우(Park Jong Woo)
- Size : 25cm x 25cm

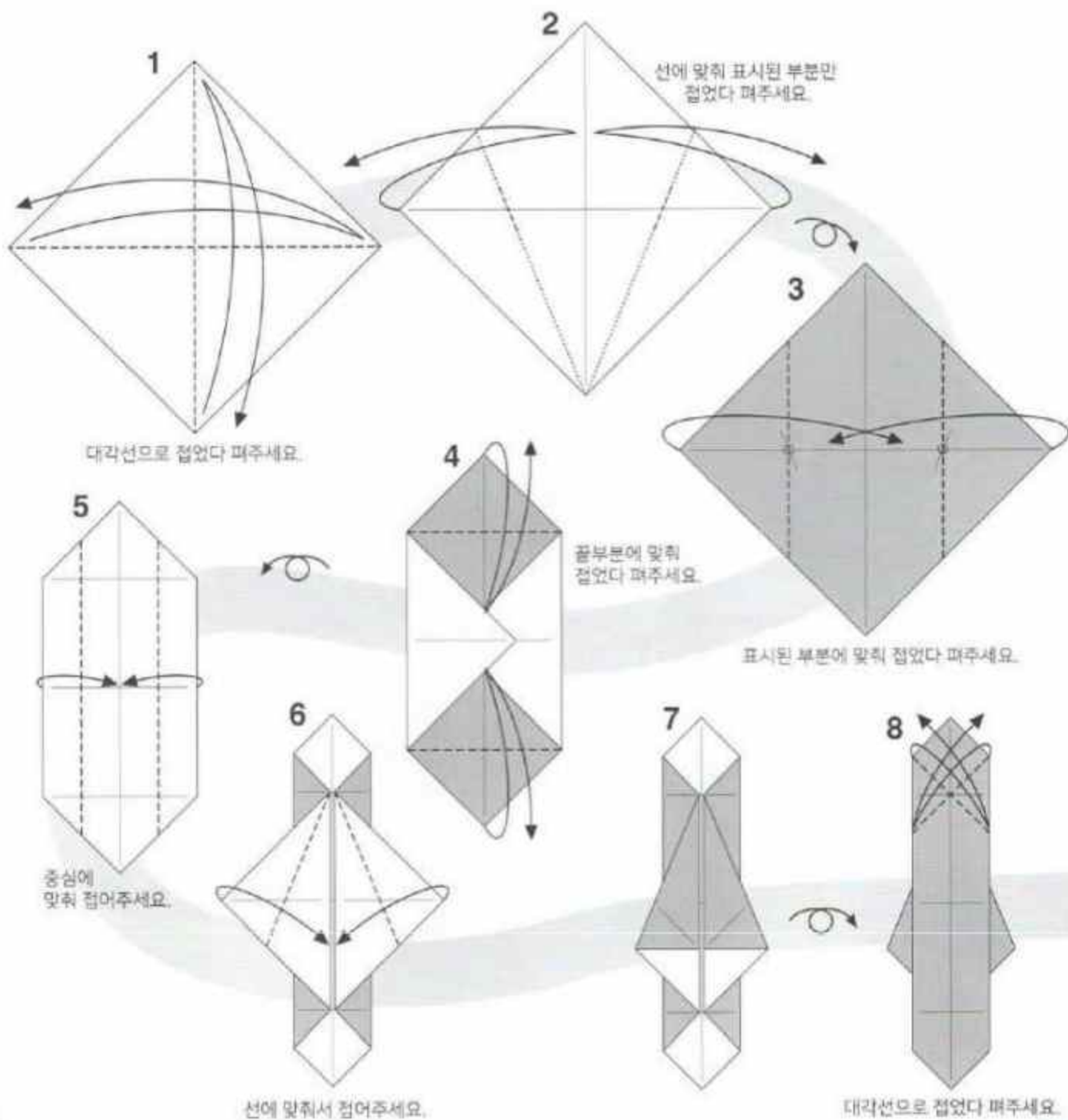
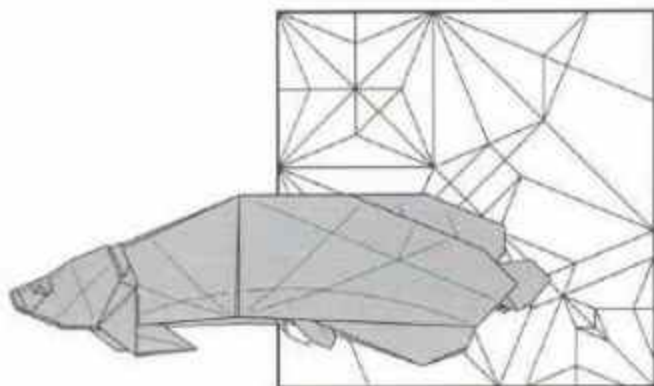

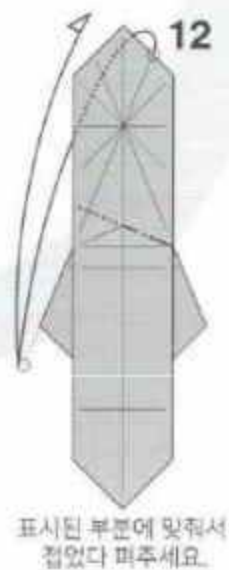
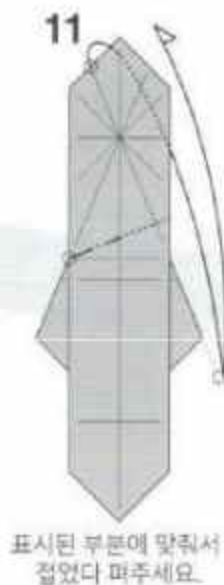
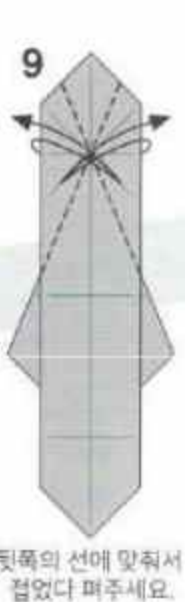
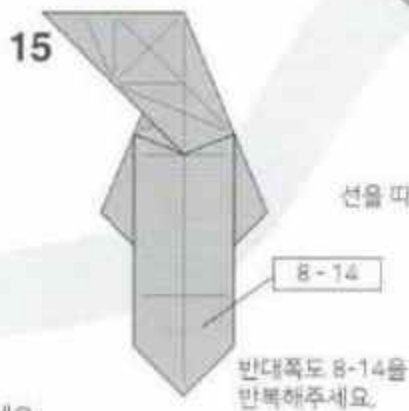
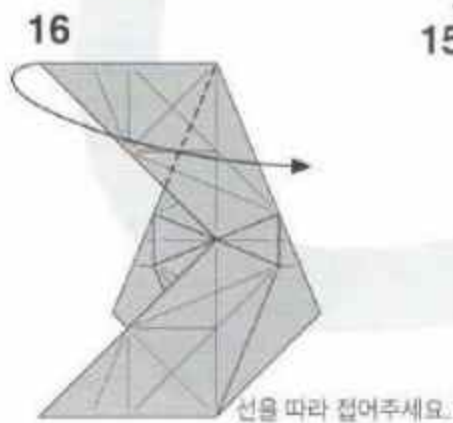
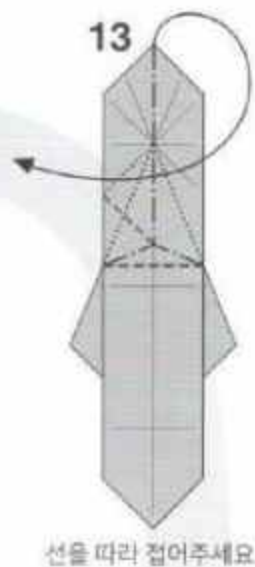
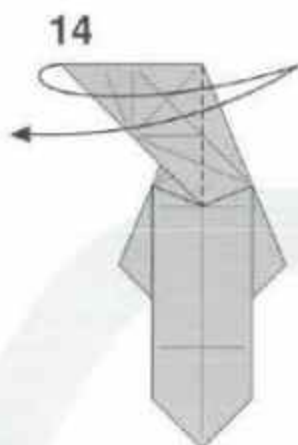
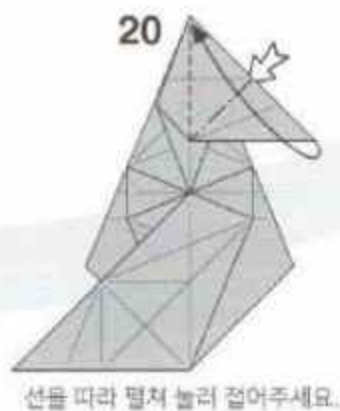
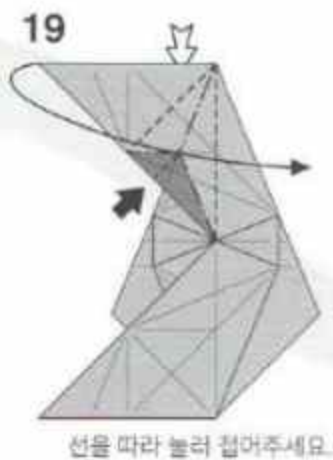
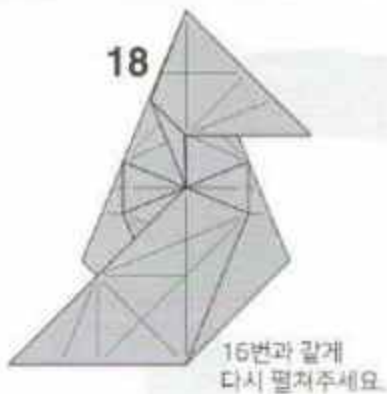

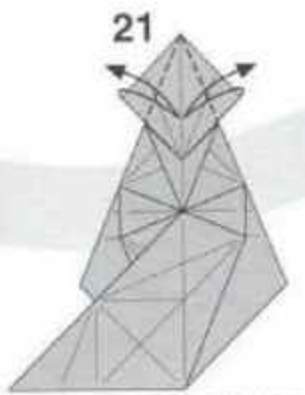

선을 따라 접었다 펴주세요.

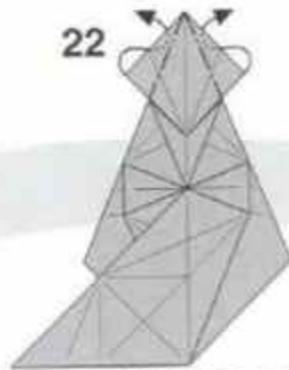

안쪽으로 펼쳐 눌러 접어주세요.



접었다 펴주세요.

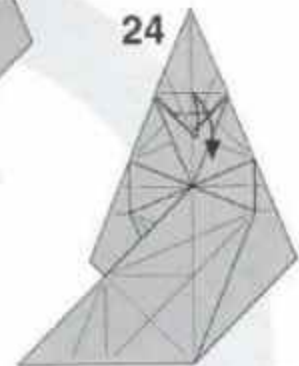

선에 맞춰 접었다 펴주세요.

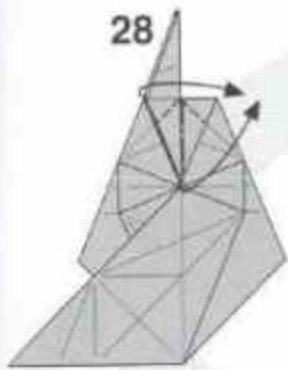

내린 종이를
앞으로 접어 올리세요.

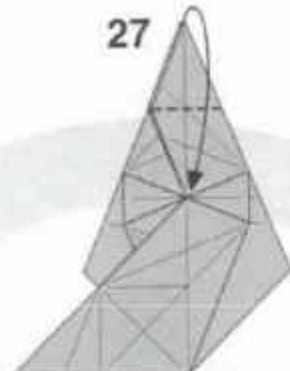

종이를 아래로 내려주세요.

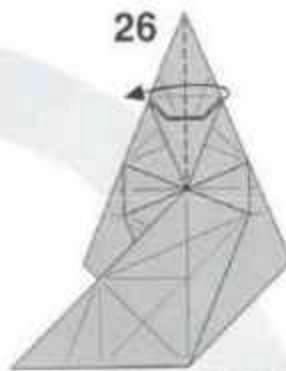

종이를 앞으로 넘겨주세요.

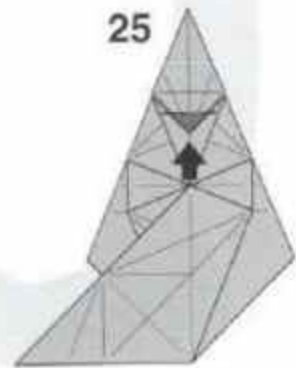

함몰접기
(Open sink)

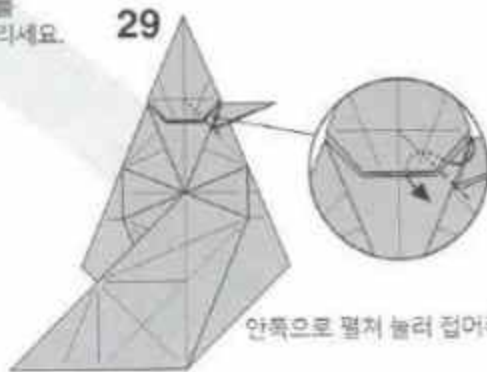

안쪽으로 펼쳐 눌러 접어주세요.

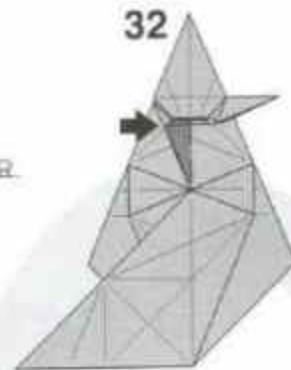

함몰접기
(Closed sink)

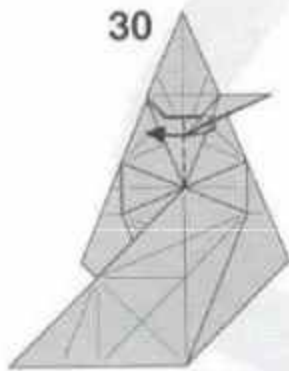

종이를 앞으로 접어주세요.

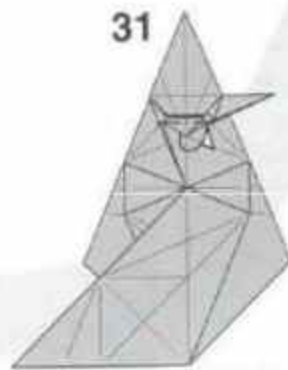

뒷쪽으로 접어주세요.

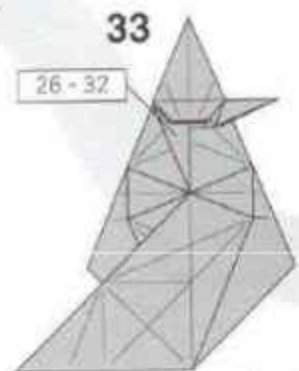

반대쪽도 26-32를 반복해주세요.

43

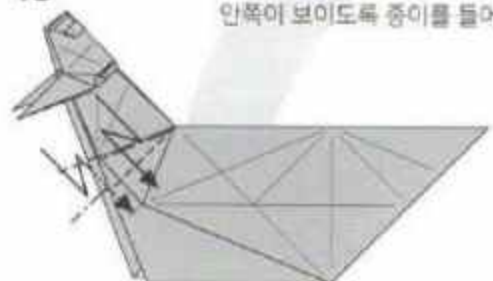

선을 따라 계단접기 해주세요.



42

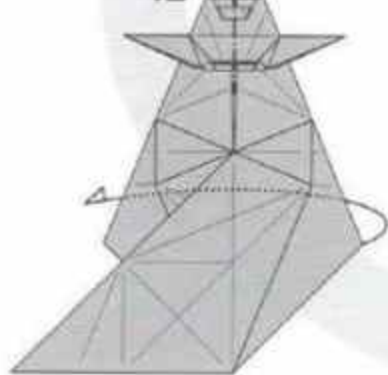

반으로 접어주세요.

34

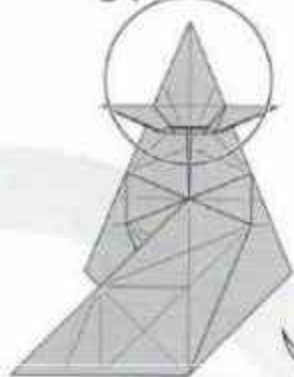

머리 부분을 꺾주세요.

35



표시된 부분에 맞춰 접었다 펴주세요.

36



표시된 부분에 맞춰 접었다 펴주세요.

38

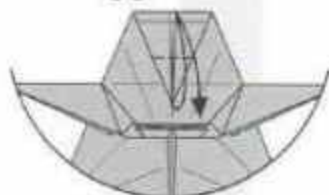

끝부분에 맞춰 접었다 펴주세요.

37



35와 36의 선에 맞춰 접어주세요.

44

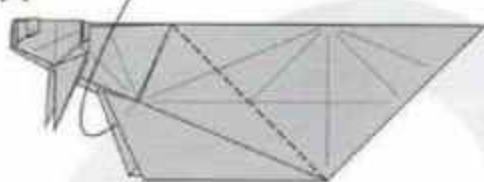

안쪽이 보이도록 종이를 들어 접어주세요.

46

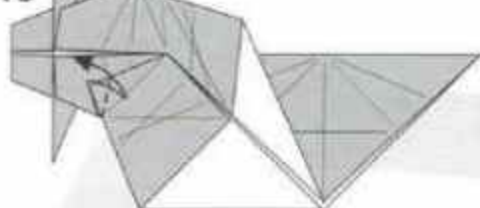

표시된 선을 따라 접었다 펴주세요.

45

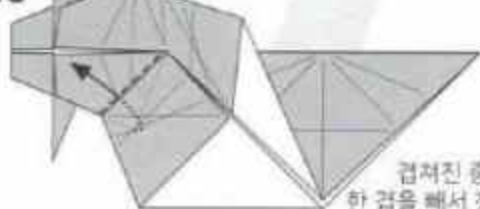

겹쳐진 종이 중에서 한 겹을 뺀 후 접어주세요.

40



뒷부분을 꺾어주세요.

41



끝부분을 살짝 접어주세요.

39



옆쳐 눌러 접어주세요.

47

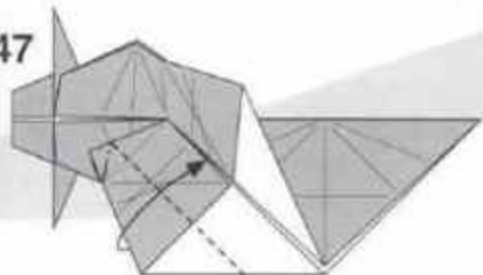

표시된 선을 따라 접어주세요.

48

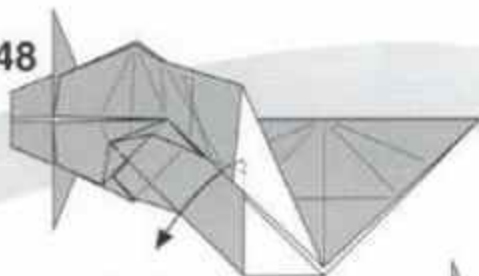

선을 따라 접어주세요.

49

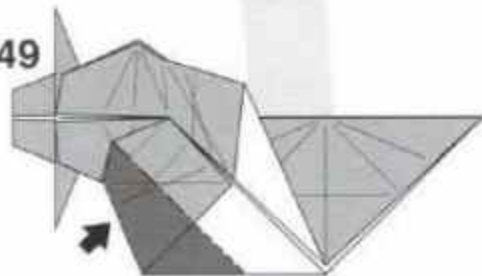

함몰접기
(Closed sink)

52

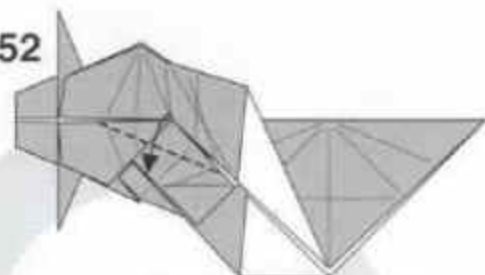

표시된 선을 따라 접어 내리세요.

50

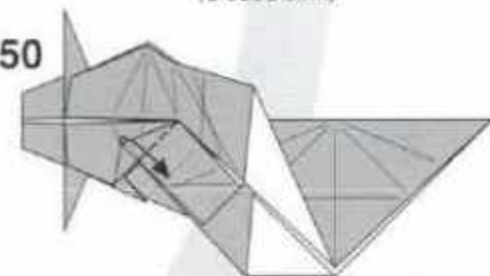

표시된 선을 따라 접어 내리세요.

53

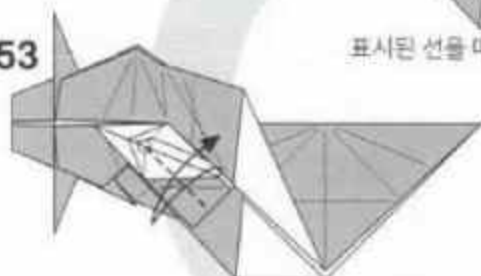

표시된 선을 따라 접었다 펴주세요.

51

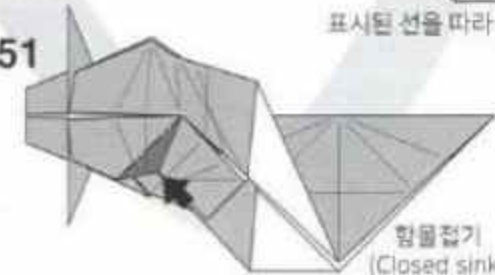

함몰접기
(Closed sink)

54



안쪽으로 펼쳐 놓아 접어주세요.

57

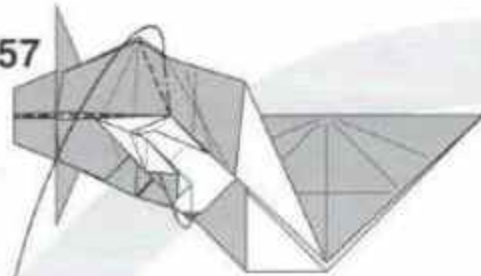

55

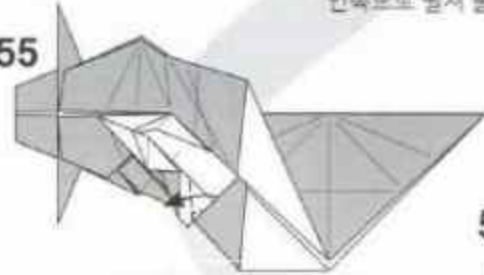

표시된 선을 따라 접어주세요.

56

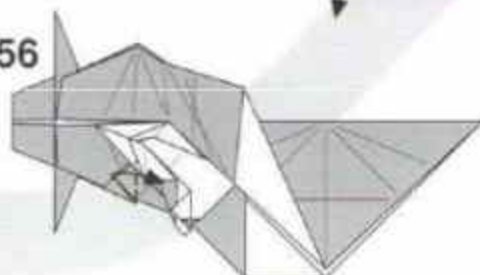

표시된 선을 따라 접어주세요.

68



59번과 함께
다시 펼쳐주세요.

67

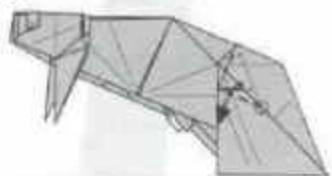

표시된 선을 따라 접어 내리세요.

66

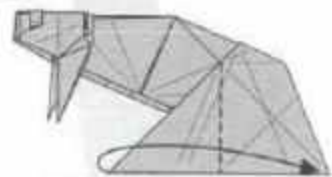

표시된 선을 따라 접어주세요.

65



62번과 함께
다시 펼쳐주세요.

58



반대쪽도 45-56을 반복해주세요.

59

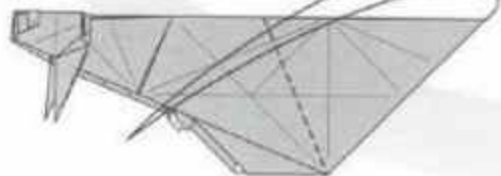

표시된 선을 따라 접었다 펴주세요.

69



표시된 부분을 뒤흔들시킴으로써
계단잡기 해주세요.



70



안쪽으로 펼쳐 뒤흔들기 해주세요.

71



67의 선을 이용하여
꼬리를 아래로 당겨주세요.

63



표시된 부분에 맞춰 접어 내리세요.

64



표시된 부분들이
맞닿도록 접어주세요.

62

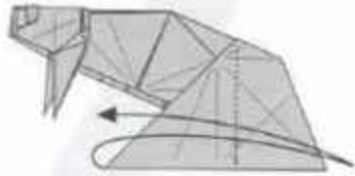

끝부분에 맞춰 아래쪽만 접었다 펴주세요.

61



선을 따라 접어주세요.

60



표시된 선을 따라 접었다 펴주세요.

72



눌러 접지 마세요.
(Do not fold sharply)

73

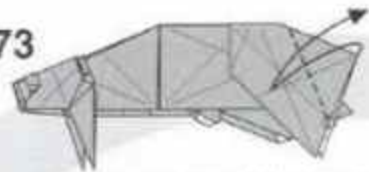

표시된 부분에 맞춰 접었다 펴주세요.

74

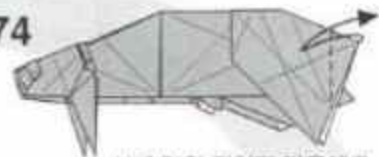

선에 맞춰 접었다 펴주세요.

75

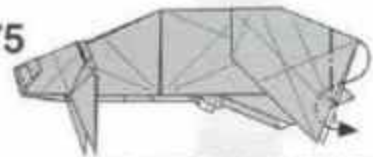

안쪽으로 펼쳐 눌러 접어주세요.
(Inside reverse fold)

77



다시 접어 올리세요.

78

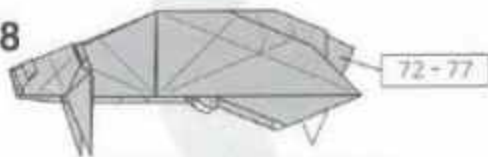

반대쪽도 72-77을 반복해주세요.

76



선에 맞춰 접어주세요.

79



꼬리의 안쪽을 펴주세요.

87



안쪽으로 펼쳐 눌러 접어주세요.
(inside reverse fold)

88



다시 전체를 펴주세요.

80



선에 맞춰 접었다 펴주세요.

86



표시된 선을 따라
접었다 펴주세요.

85



표시된 선을 따라 접어주세요.

81



표시된 선을 따라
눌러 접어주세요.

82



뒷쪽의 종이층을
앞으로 꺼내주세요.

83



표시된 선을 따라
접었다 펴주세요.

84



선을 따라 펼쳐 눌러 접어주세요.

99

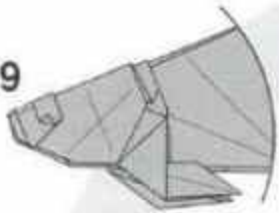

지느러미 완성

100

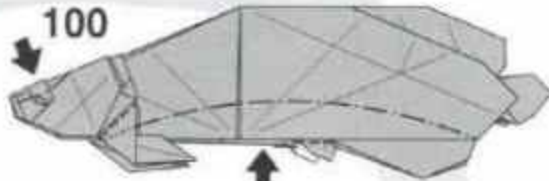

전체적으로 동글게 다듬어주세요.

98



반대쪽도 97을 반복해주세요.

101

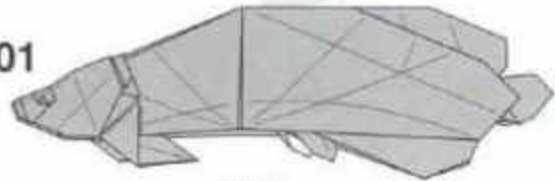

완성

97



펼쳐 눌러 접어주세요.

96



반대쪽도 반복해주세요.

89

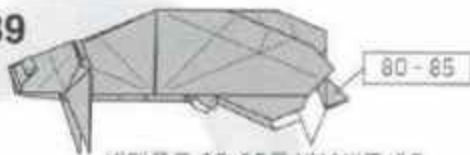

반대쪽도 80-85를 반복해주세요.

95



반대쪽도 반복해주세요.

90

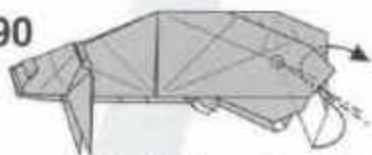

안쪽으로 펼쳐 눌러 접어주세요.
(inside reverse fold)

94

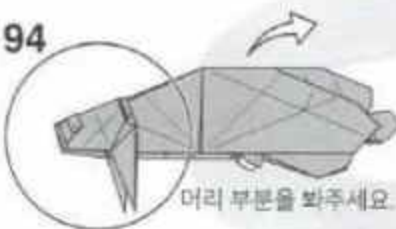

머리 부분을 봐주세요.

93

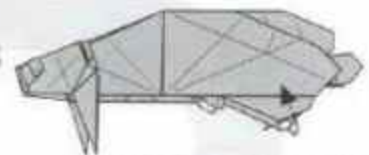

87의 공간 안쪽으로 접어주세요.

91



81의 라인을 따라 접어주세요.
반대쪽도 반복해주세요.

92



안쪽으로 펼쳐 눌러 접어주세요.

빨간둥돔

Red snapper

- Creator : 맹형규(Maeng Hyeong Kyu)
- Diagram : 맹형규(Maeng Hyeong Kyu)
- Size : 30cm x 30cm

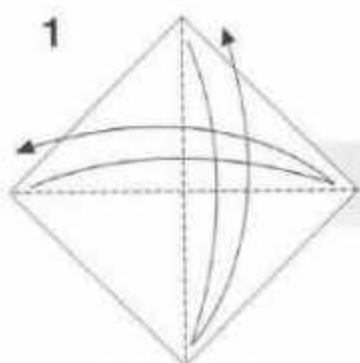
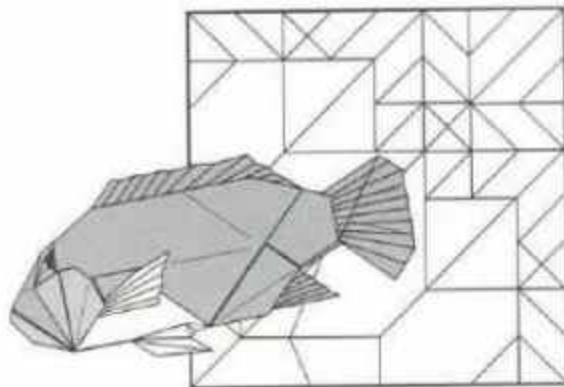

1 접었다 펼쳐주세요.

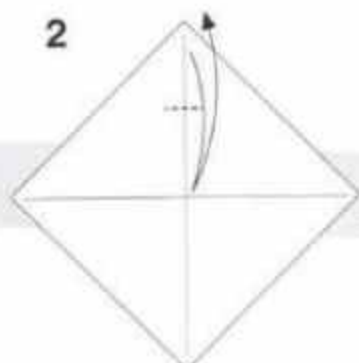

2 아래로 접었다 펼쳐주세요.

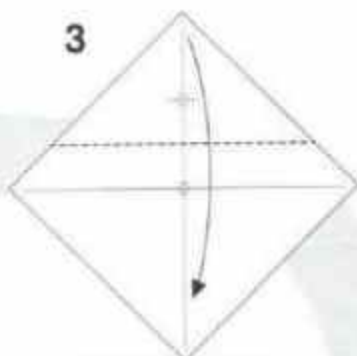

3 아래로 내려주세요.

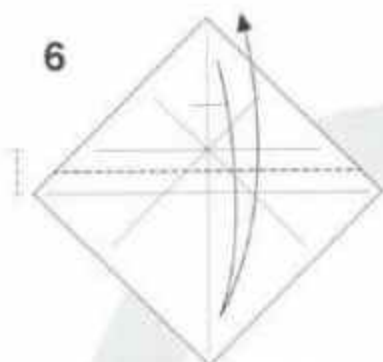

6 아래로 접었다 펼쳐주세요.

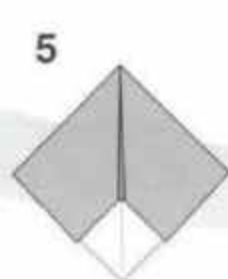

5 모두 펼쳐주세요.

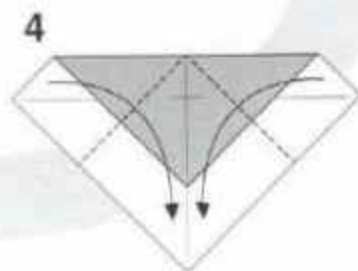

4 아래로 내려주세요.

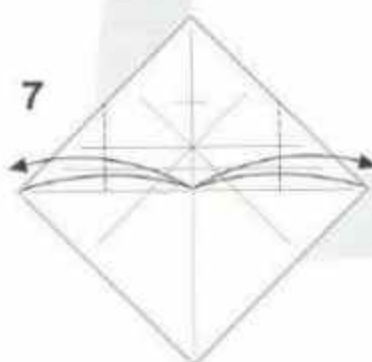

7 가운데에 맞춰 접었다 펼쳐주세요.

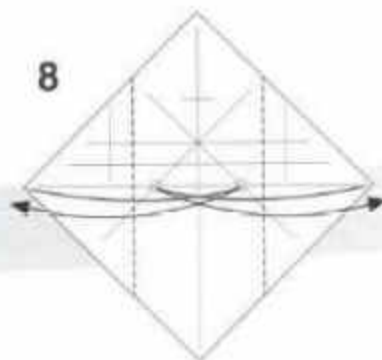

8 기준점을 참고하여 접었다 펼쳐주세요.

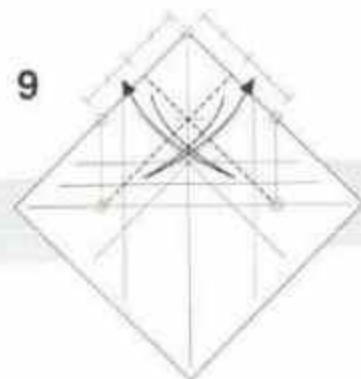

9 기준점을 참고하여 접었다 펼쳐주세요.

18

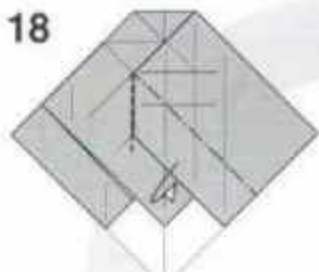

뒤로 접어주세요.

19

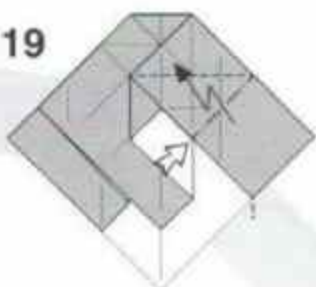

안쪽을 펼치며 선을 따라
위로 접어주세요.

21



안쪽 안쪽 바깥으로 펴주세요.

20

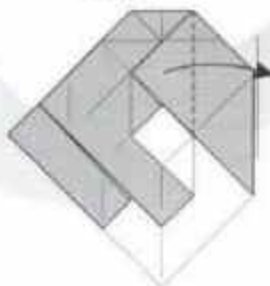

옆으로 펴주세요.

17

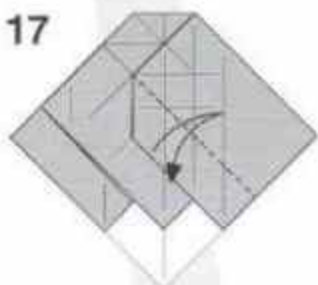

위로 접었다 펼쳐주세요.

14

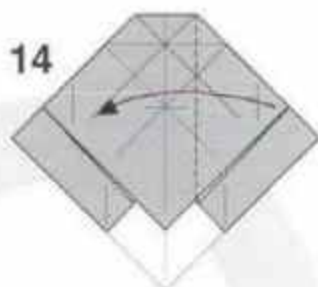

옆으로 펴주세요.

15

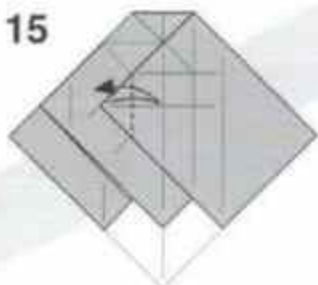

옆으로 접었다 펼쳐주세요.

16

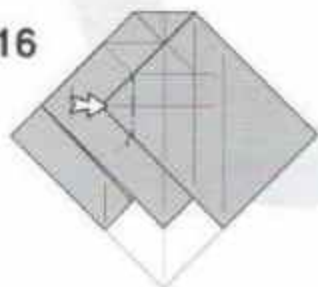

안쪽으로 넣어주세요.

13

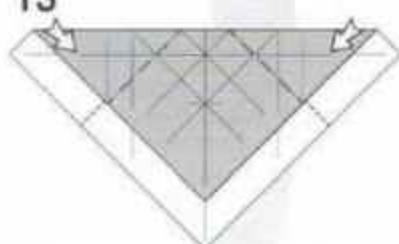

안쪽으로 펼쳐 눌러 접어주세요.

10

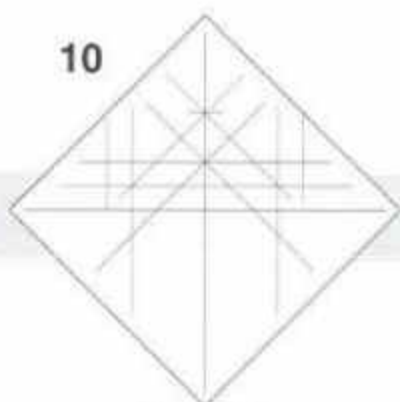

기본 선 완성

11

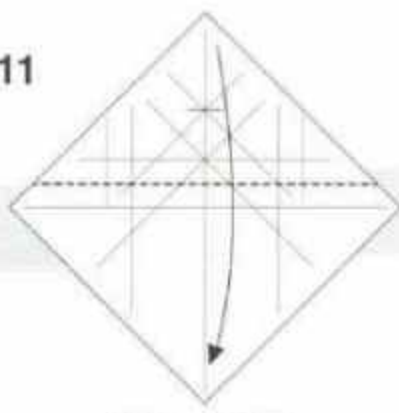

아래로 내려주세요.

12

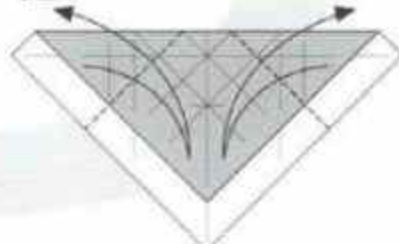

아래로 접었다 펼쳐주세요.

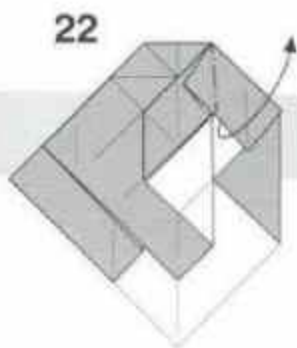

22

펼치며 위로 올려주세요.

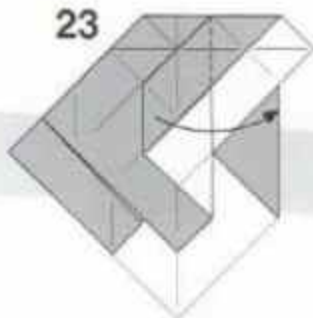

23

옆으로 밀어주세요.

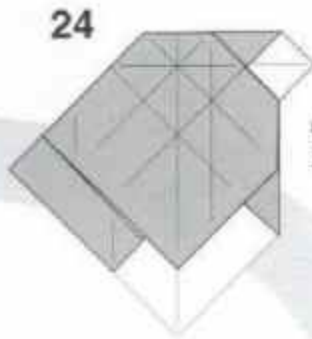

24

반대쪽도 14-23번의 과정을 반복해주세요.

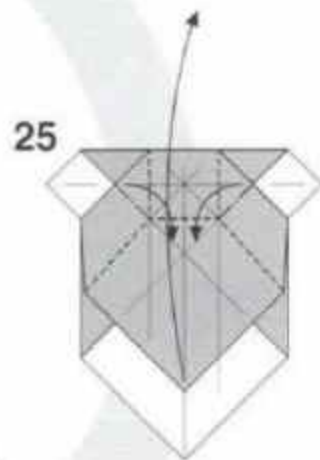

25

선을 따라 안쪽으로 모아주며 위로 올려주세요.

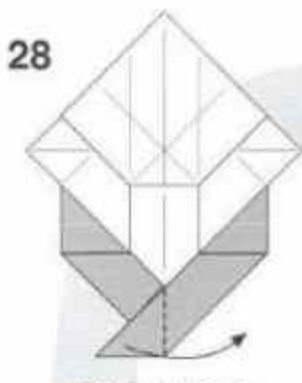

28

옆으로 밀어주세요.

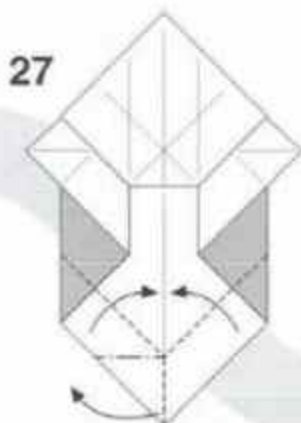

27

접힌 선을 따라 안쪽으로 모아주세요.

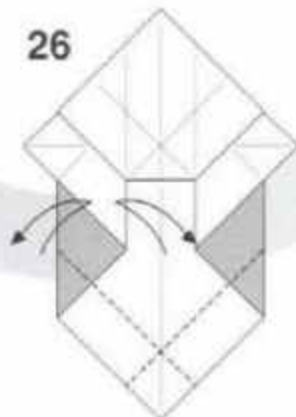

26

위로 접었다 펼쳐주세요.

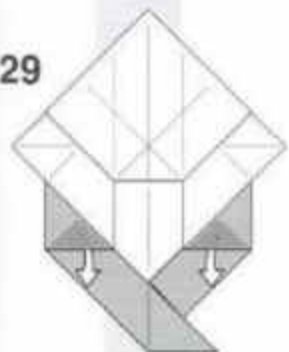

29

안쪽을 바깥으로 빼주세요.

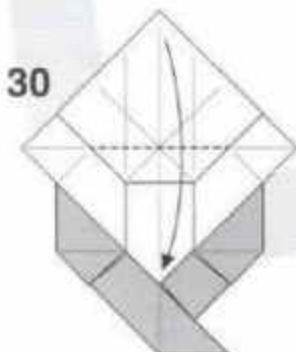

30

아래로 내려주세요.



31

아래로 내려주세요.

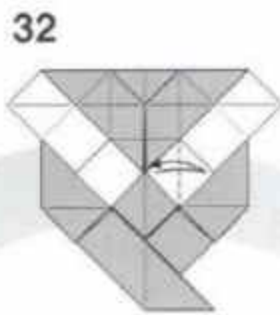

32

옆으로 접었다 펼쳐주세요.

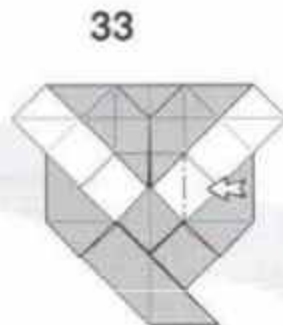

33

안쪽으로 넣어주세요.



42

반대쪽도 39-41번의 과정을 반복해주세요.

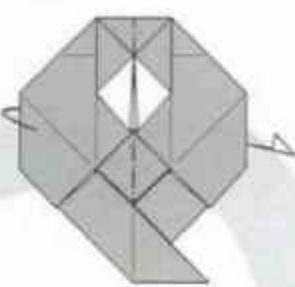

43

뒤로 반을 접어주세요.

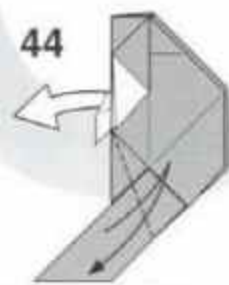

44

접었다 펼친 뒤 45번의 모양으로 돌아와주세요.

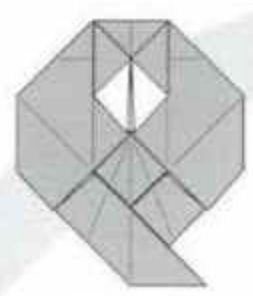

45

뒤집어주세요.

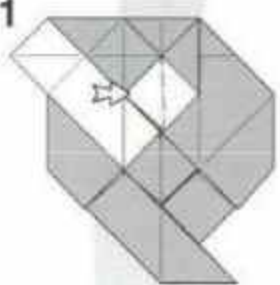

41

안쪽으로 넣어주세요.

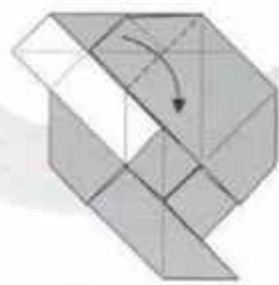

40

아래로 내려주세요.

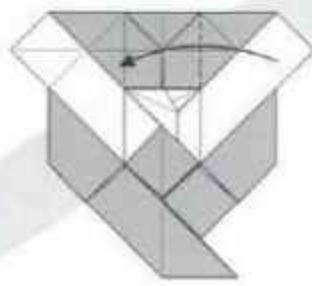

39

앞으로 밀어주세요.



38

반대쪽도 32-37번의 과정을 반복해주세요.

37

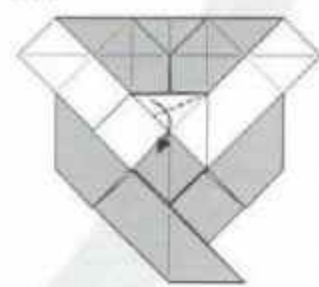

아래로 내려주세요.

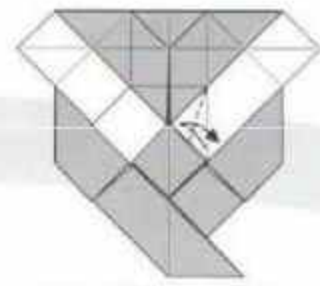

34

앞으로 접었다 펼쳐주세요.

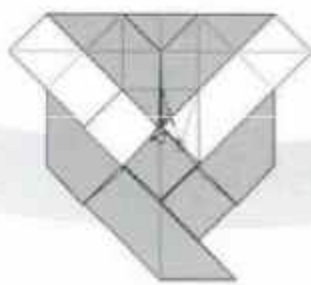

35

뒤로 밀어주세요.



36

안쪽을 펼치며 앞으로 밀어주세요.

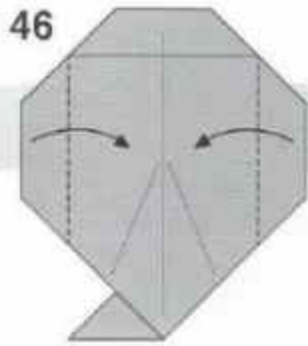

안쪽으로 접어주세요.

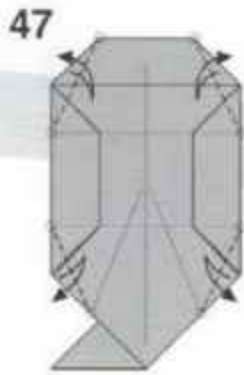

기준점을 잘 보고 안쪽으로 접었다 펼쳐주세요.

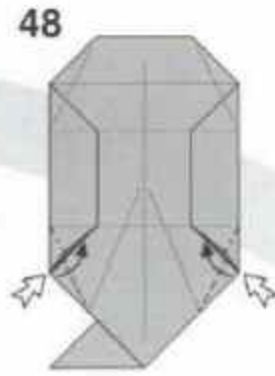

접힌 선을 안쪽으로 펼치며 넣어주세요.

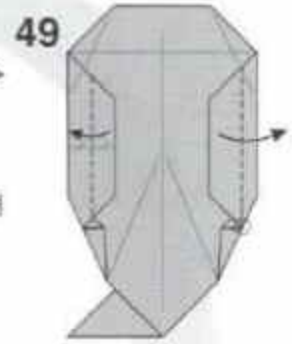

한쪽은 반을 접어주고 다른 한쪽은 기준점을 따라 접어주세요.

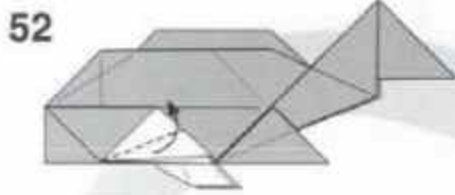

반대쪽이랑 동시에 진행해주세요.

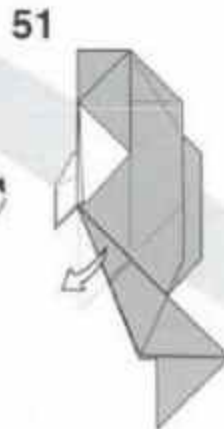

안쪽면을 바깥으로 빼주세요.



위로 올려주세요.

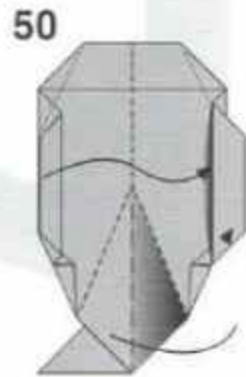

반 접힌 선을 다른 쪽으로 넣어주며 손바닥 따라 안쪽으로 접어주세요.



내려주세요.

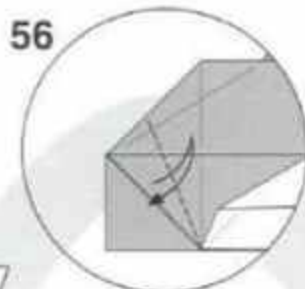

옆으로 접었다 펼쳐주세요.



확대

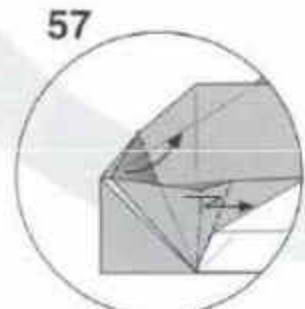

선을 따라 옆으로 넘겨주세요.

66

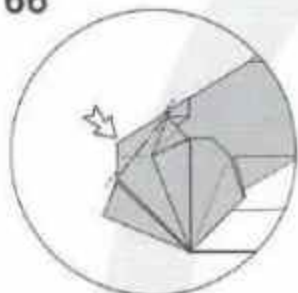

안쪽으로 넣어주세요.

67

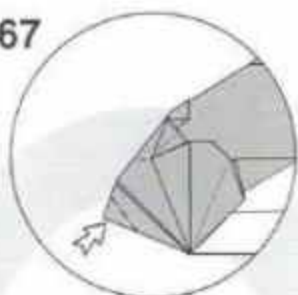

안쪽으로 넣어주세요.

68

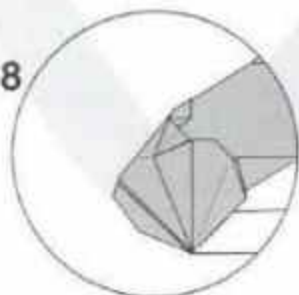

족소

69

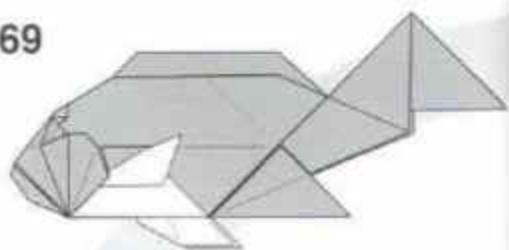

65

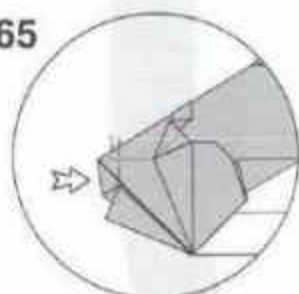

안쪽으로 넣어주세요.

64

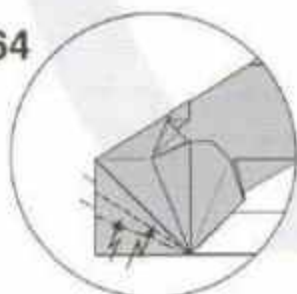

바깥으로 감싸며 계단접기를 해주세요.

63

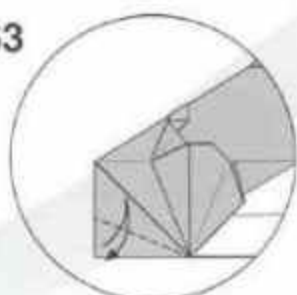

위로 접었다 펼쳐주세요.

62

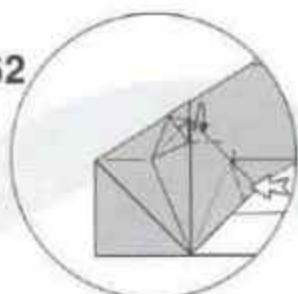

안쪽으로 넣어주세요.

61

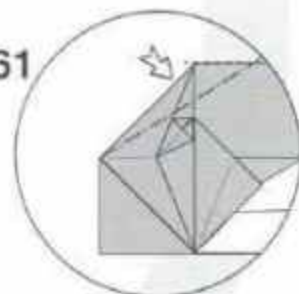

안쪽으로 누르며 집어 넣어주세요.

58

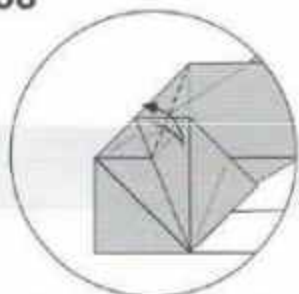

아래로 접었다 펼쳐주세요.

59

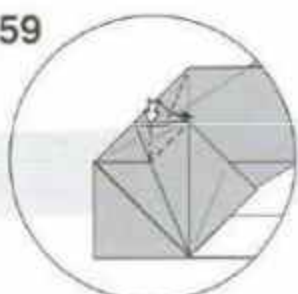

안쪽을 펼치며 옆으로 넘겨주세요.

60

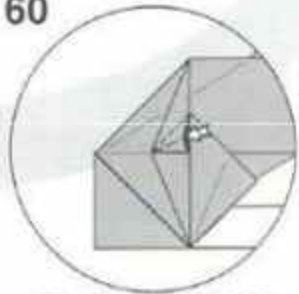

위로 펼치며 올려주세요.

70

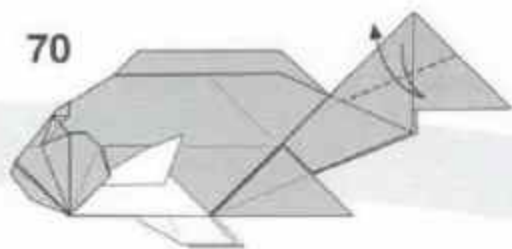

아래로 접었다 펼쳐주세요.

71

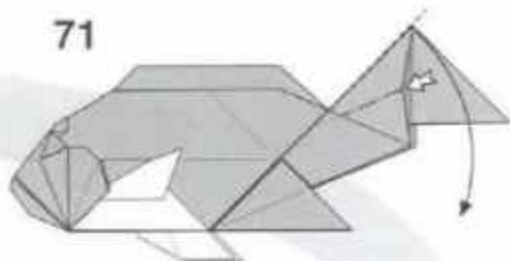

바깥으로 벌리며 내려주세요.

72

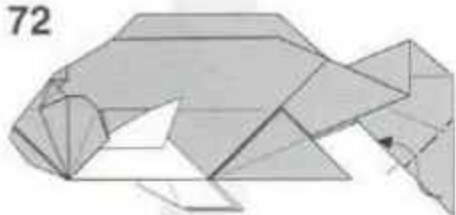

안쪽으로 넣어주세요.

74



옆으로 접었다 펼쳐주세요.

73

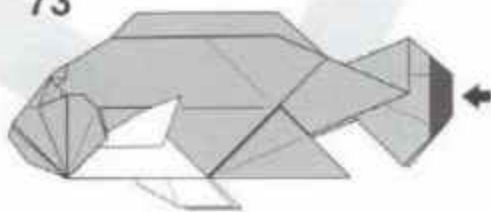

함몰집기(Open sink) 해주세요.

75

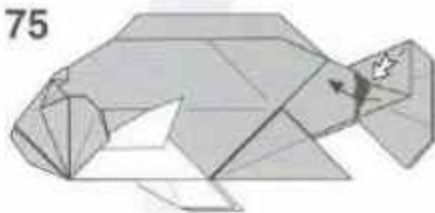

안쪽으로 펼치며 넣어주세요.

76

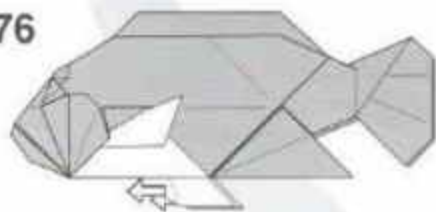

앞쪽으로 당기며 접어주세요.

78



아래로 내려주세요.

77

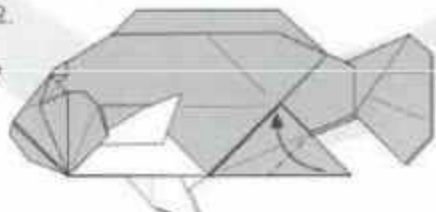

위로 접어주세요.

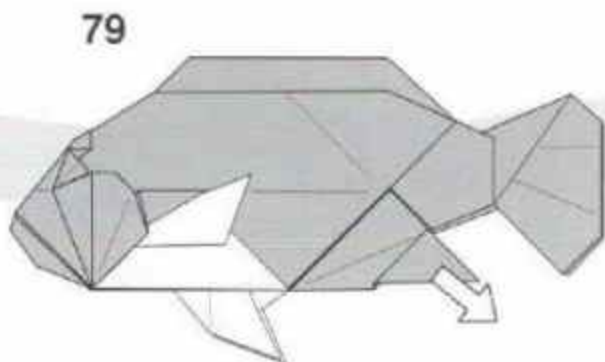
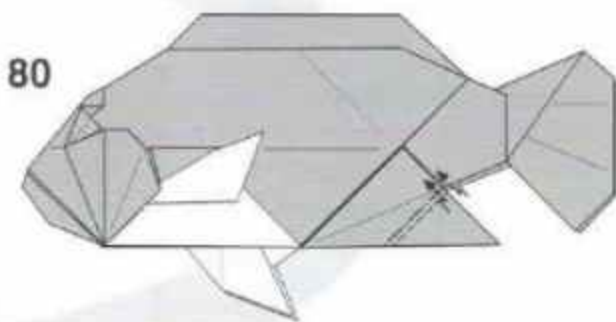
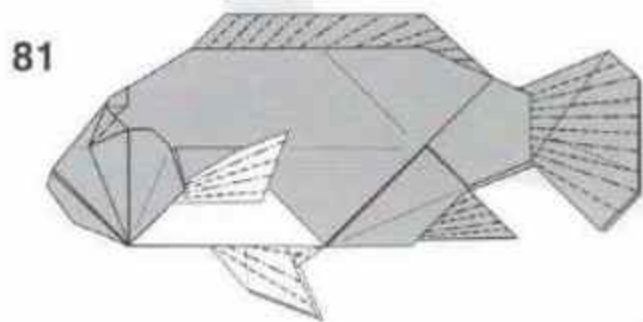
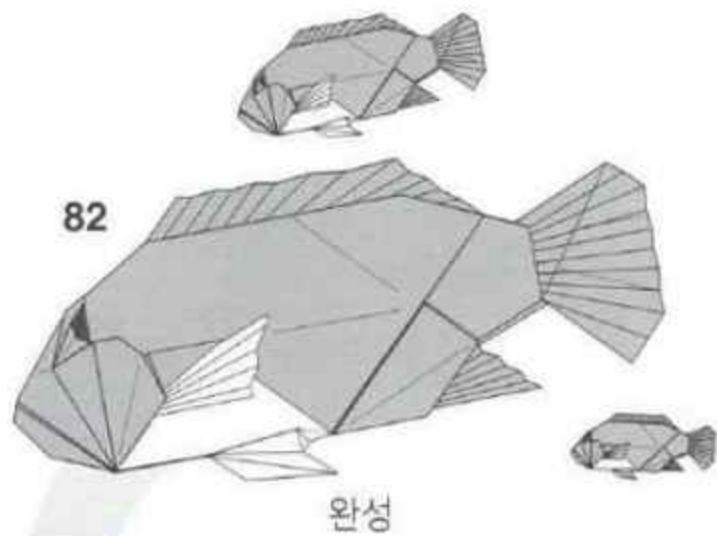

아프간하운드

Afghanhound

- Creator : 정재일(Jeong Jae Il)
- Diagram : 정재일(Jeong Jae Il)
- Size : 25cm x 25cm

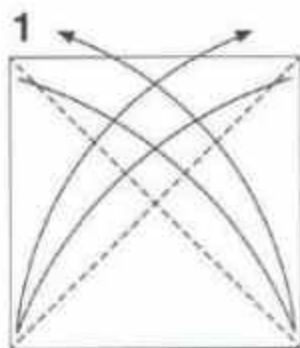
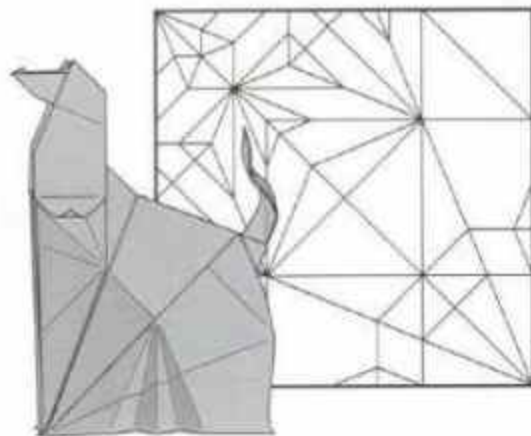

대각선으로 접었다가 펼쳐주세요.

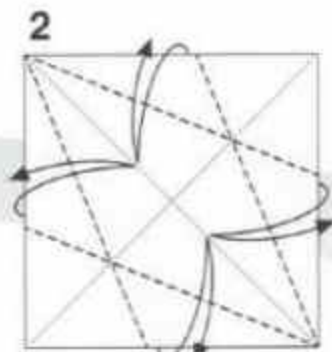

22.5° 선을 내주세요.

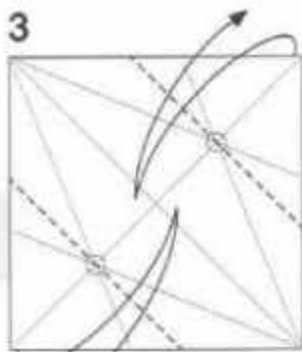

o 표시를 기준으로 접었다가 펼쳐주세요.

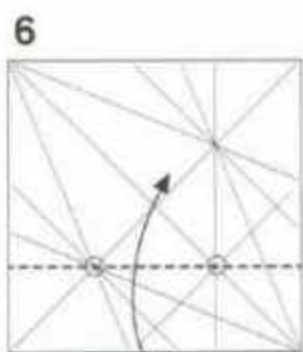

o 표시를 기준으로 접었다가 펼쳐주세요.

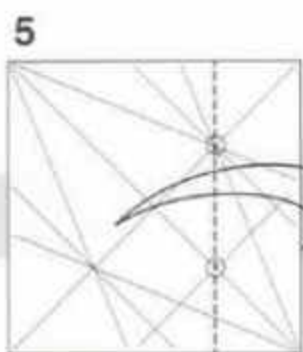

o 표시를 기준으로 접었다가 펼쳐주세요.

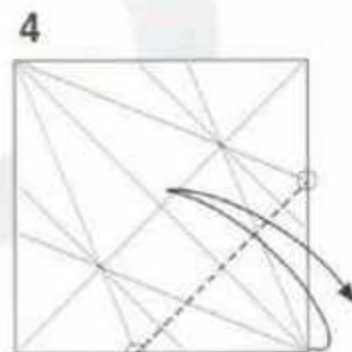

o 표시를 기준으로 접었다가 펼쳐주세요.

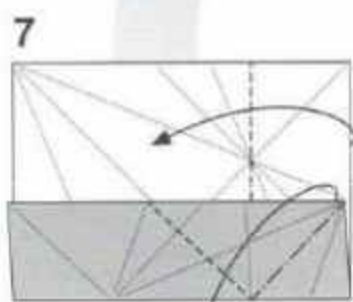

화살표를 따라 당겨 접어주세요.

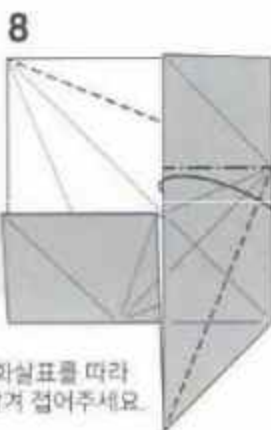

화살표를 따라 당겨 접어주세요.

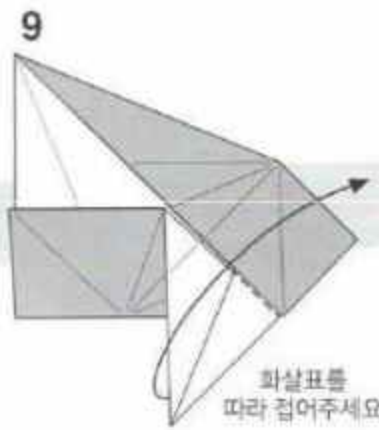

화살표를 따라 접어주세요.

19

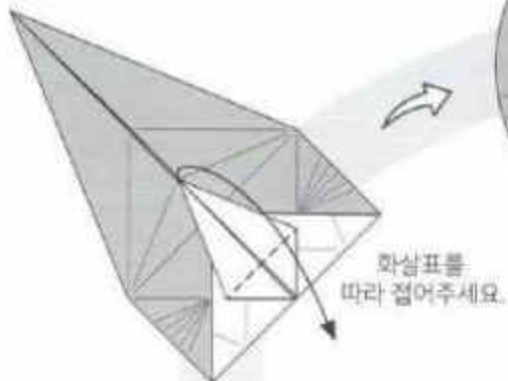

20

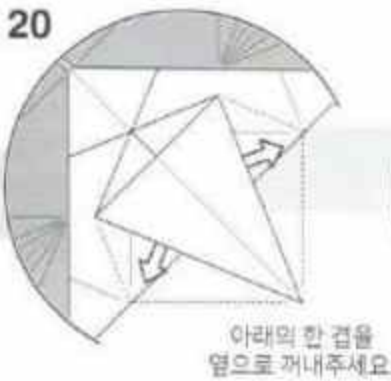

21

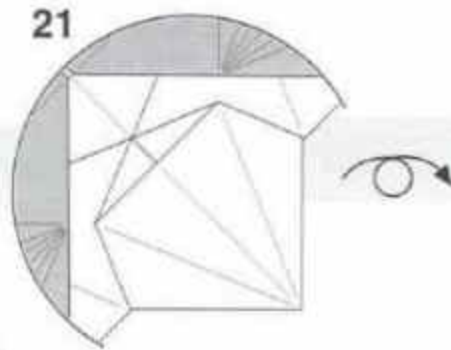

18



15



14

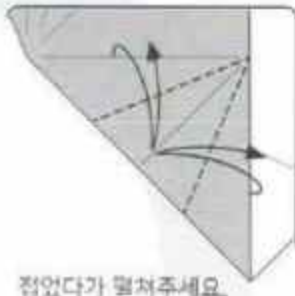

17

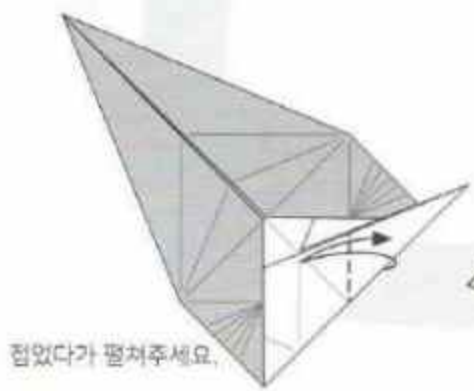

16



13

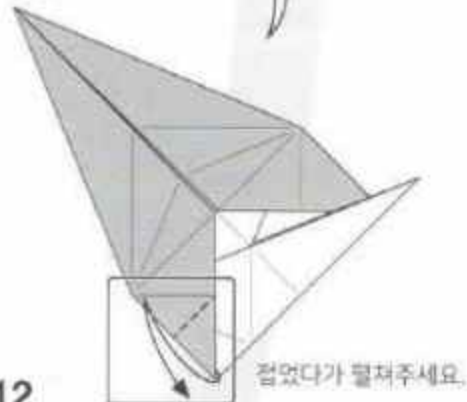

10

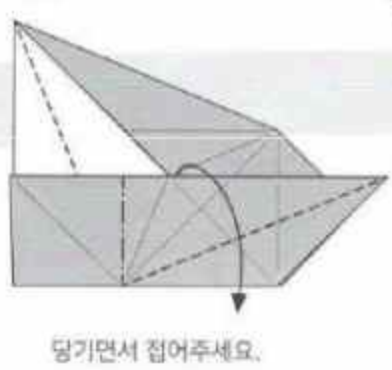

11

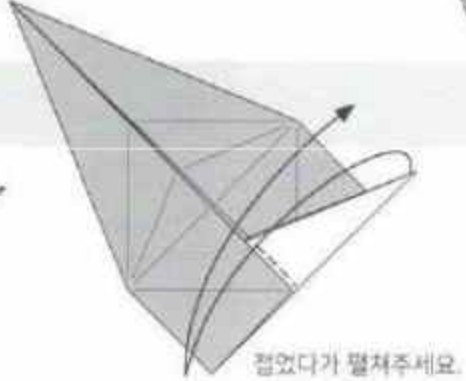

12

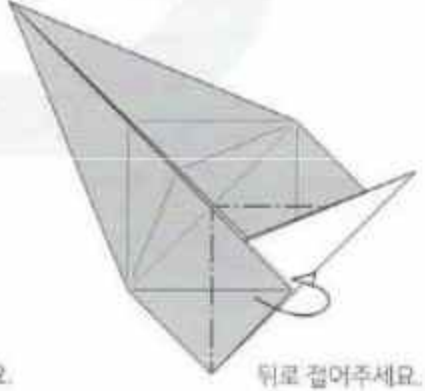

22

29

30

22

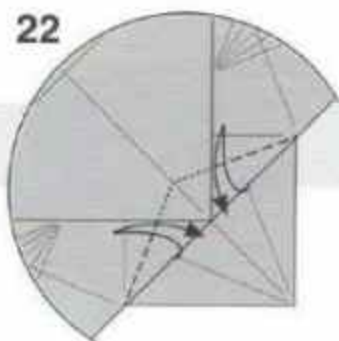

접었다가 펼쳐주세요.

23

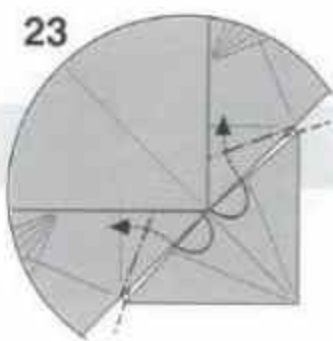

안쪽으로 접어주세요.

24

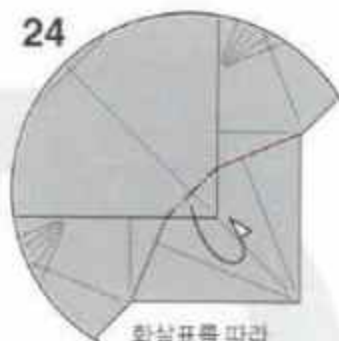

화살표를 따라
뒤로 접어주세요.

29

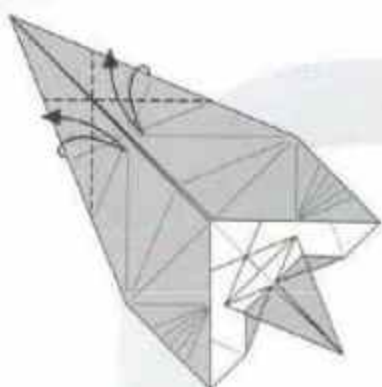

접었다가 펼쳐주세요.

28

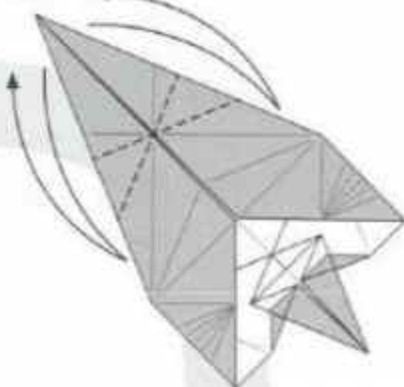

접었다가 펼쳐주세요.

25

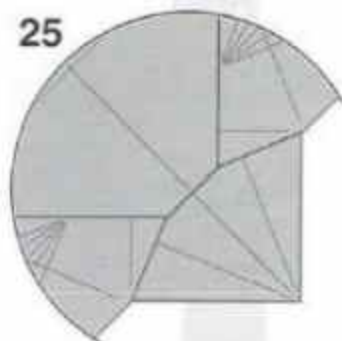

30

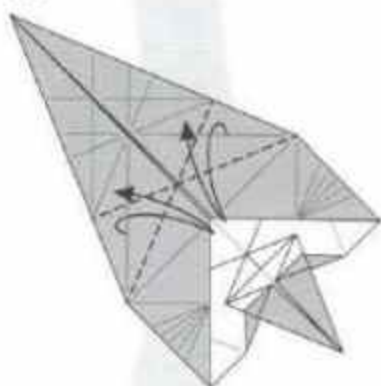

접었다가 펼쳐주세요.

27

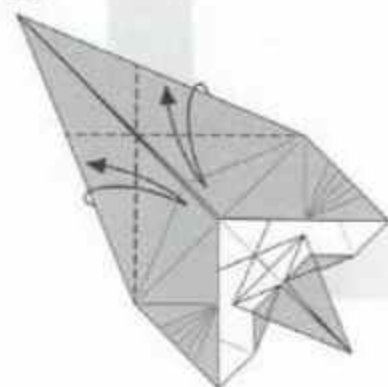

접었다가 펼쳐주세요.

26

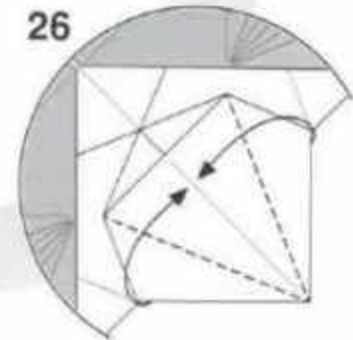

31



계단잡기 해주세요.

32

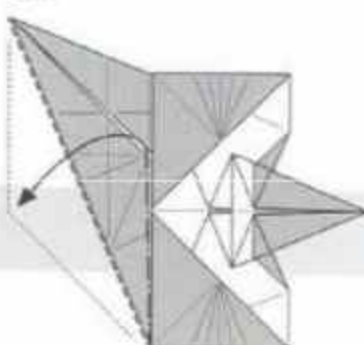

화살표를 따라 당기면서 접어주세요.

33

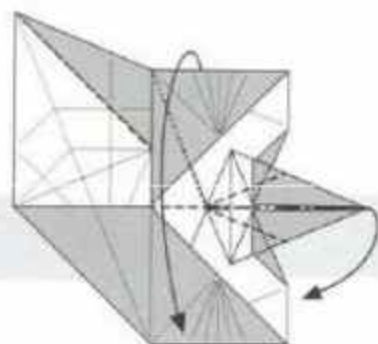

화살표를 따라 당기면서 접어주세요.

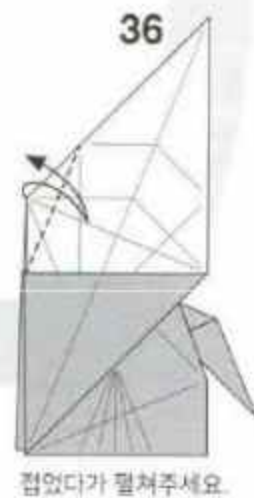
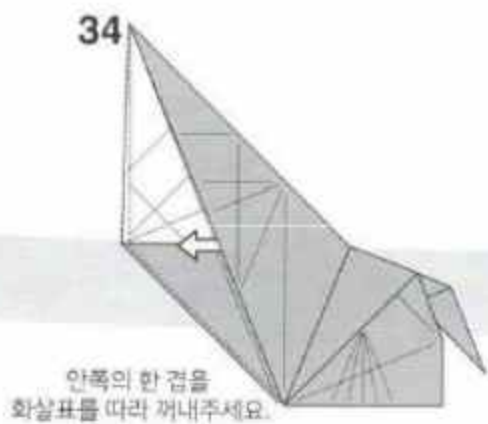
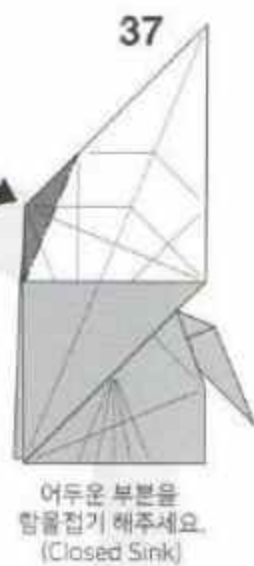
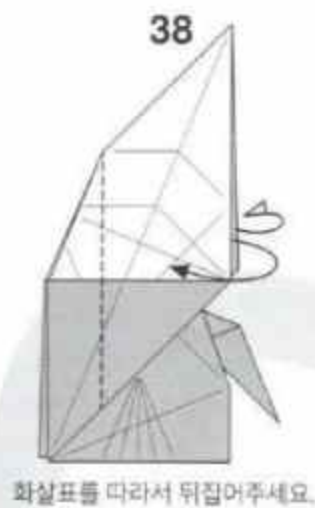
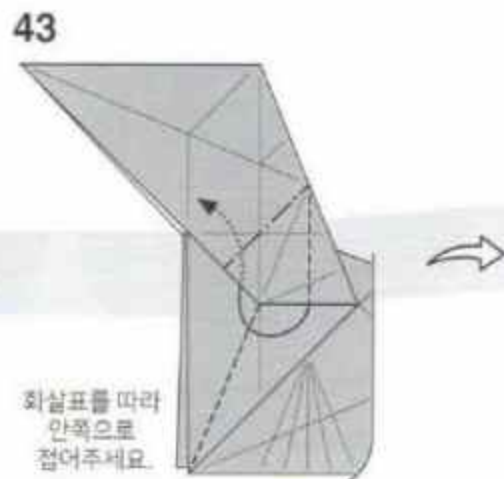
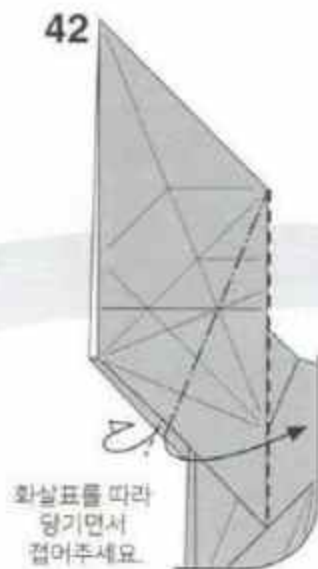
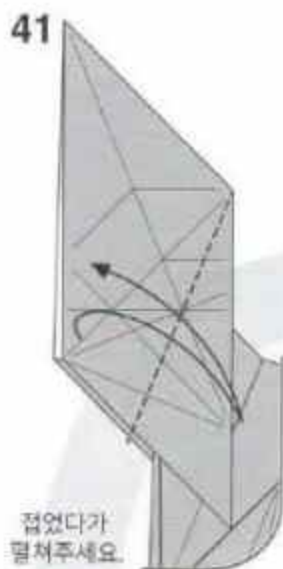

44

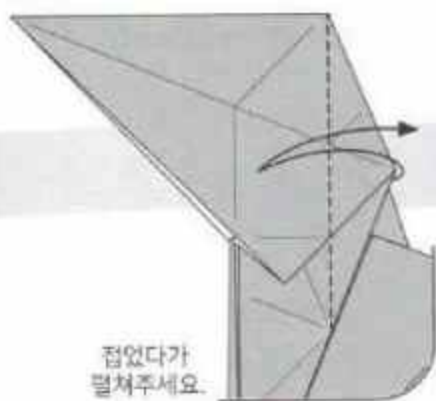

접었다가
펼쳐주세요.

45



어두운 부분을
함몰접기 해주세요.
(Open Sink)

46

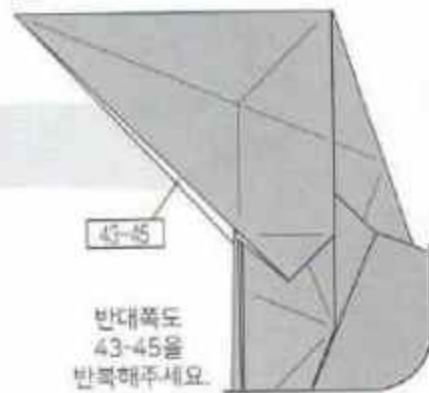

반대쪽도
43-45을
반복해주세요.

50

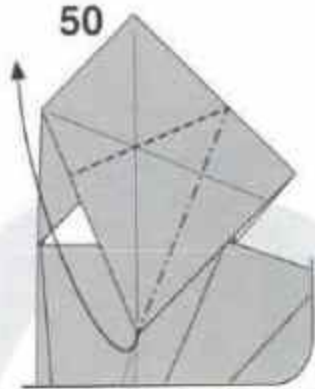

화살표를 따라 위로 접어주세요.

47

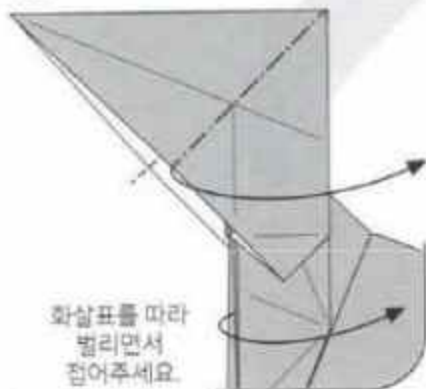

화살표를 따라
펼리면서
잡어주세요.

51

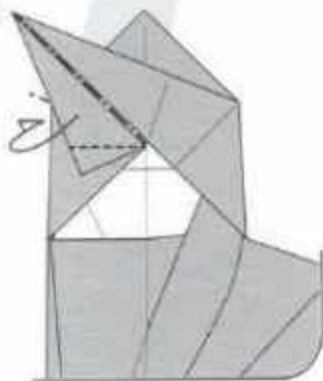

화살표를 따라 잡아주세요.

49

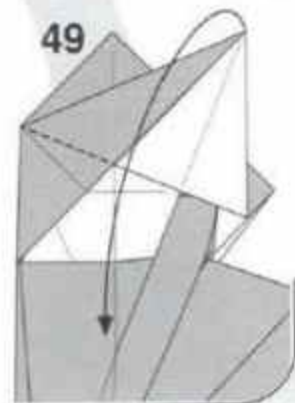

화살표를 따라 아래로 접어주세요.

48

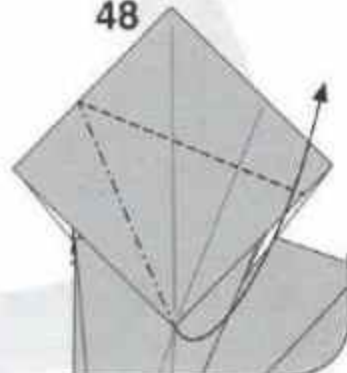

화살표를 따라 위로 접어주세요.

52

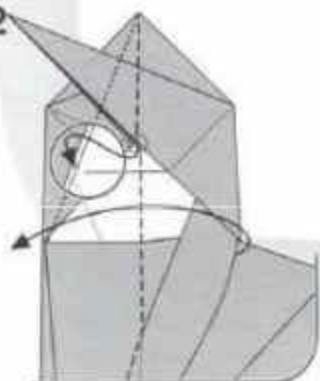

o 표시된 부분을 한결 인쪽의
주머니에 끼우면서 접어주세요.

53

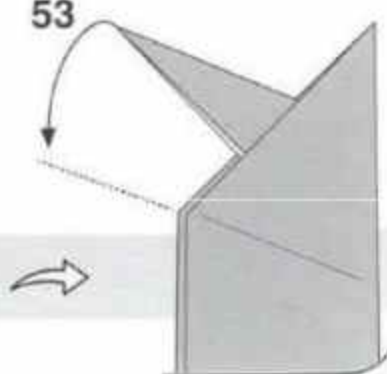

화살표를 따라
당겨 접어주세요.

54

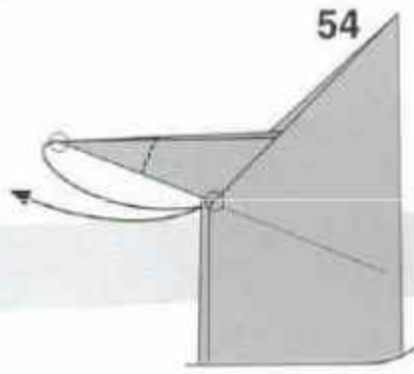

o 표시를 기준으로
접었다가 펼쳐주세요.

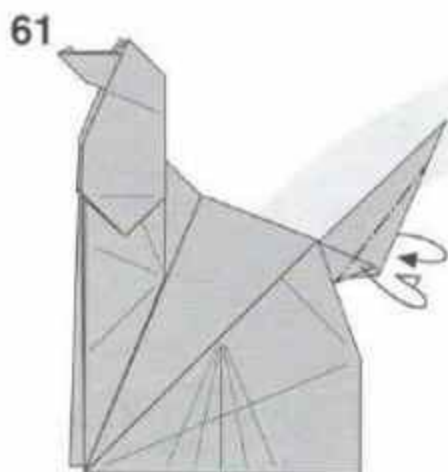

화살표를 따라 접어주세요.

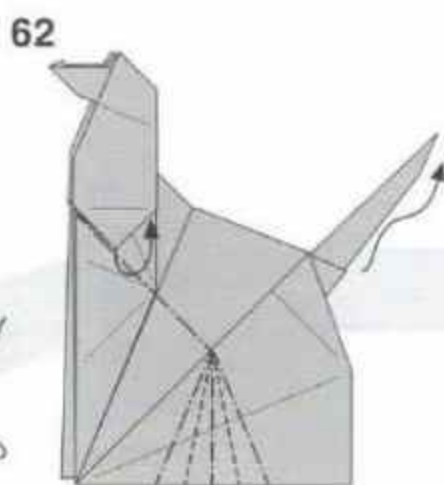

화살표와 점선을 따라 접으면서 모양을 잡아주세요.



완성

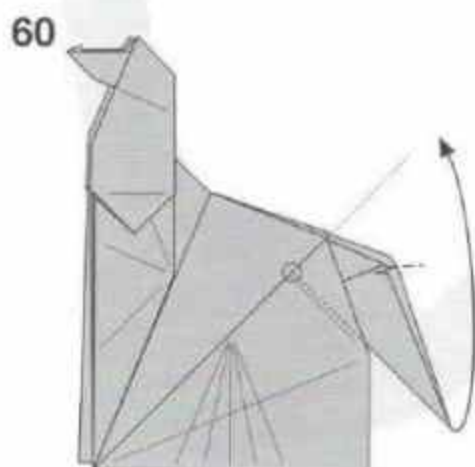

화살표를 따라 접어주세요.

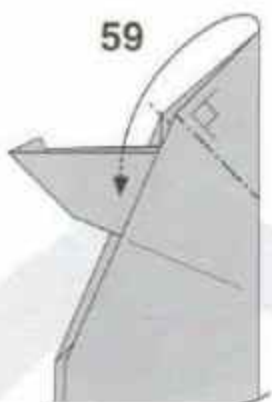

화살표를 따라 접어주세요.

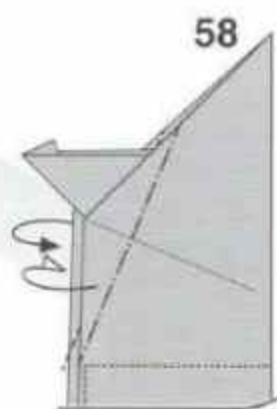

화살표를 따라 접어주세요.

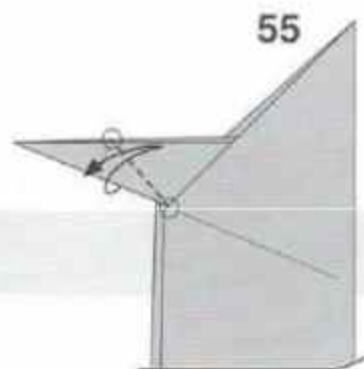

○ 표시를 기준으로 접었다가 펼쳐주세요.

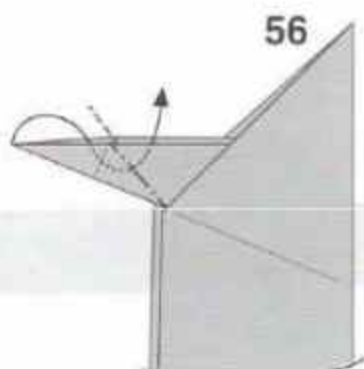

화살표를 따라 펼쳐놓리 접어주세요.

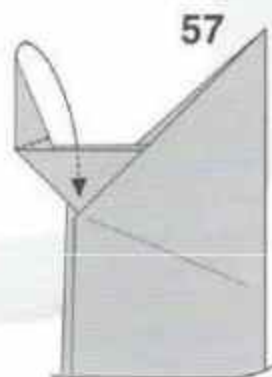

화살표를 따라 안쪽으로 접어주세요.

디모르포돈

Dimorphodon

- Creator : 박종우(Park Jong Woo)
- Diagram : 박종우(Park Jong Woo)
- Size : 25cm x 25cm

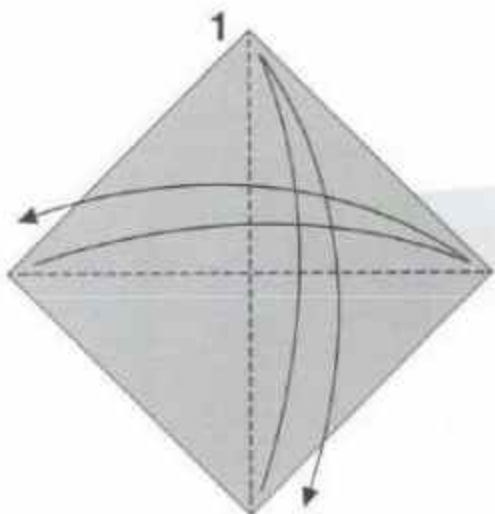
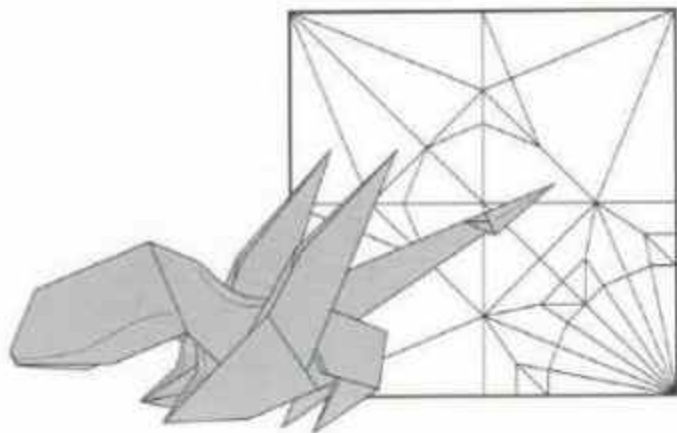

대각선으로 펼쳤다가 좌우로 접어주세요.

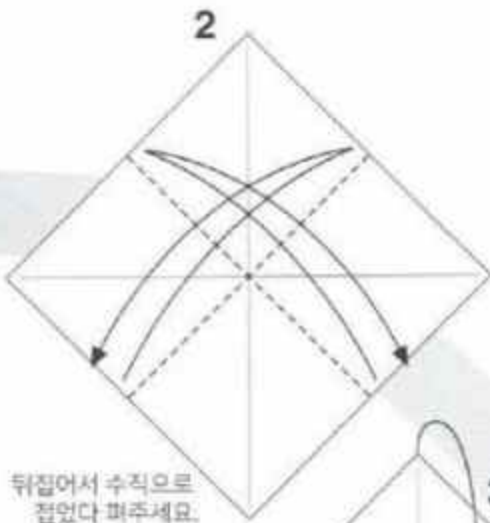

뒤집어서 수직으로 접었다 좌우로 접어주세요.

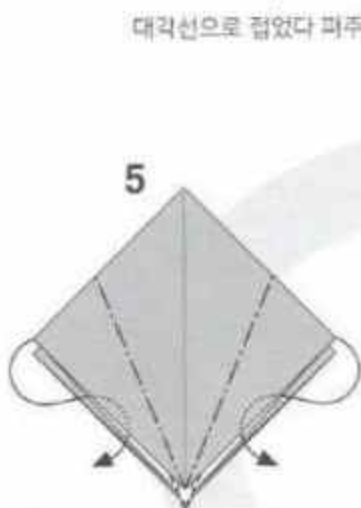

안쪽으로 펼쳐 놓기 접어주세요.

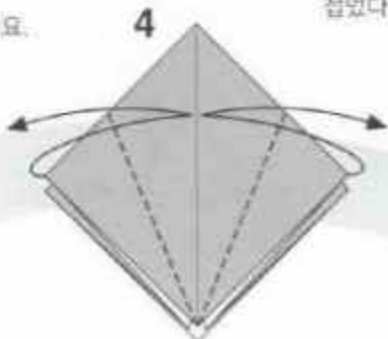

중앙선에 맞춰 접었다 좌우로 접어주세요.

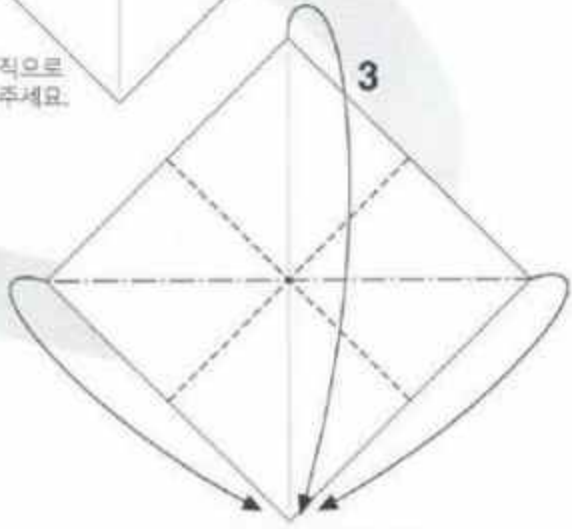

사각주머니 접기를 해주세요.

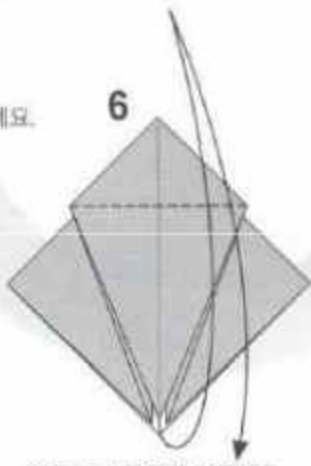

윗쪽으로 펼쳤다가 좌우로 접어주세요.

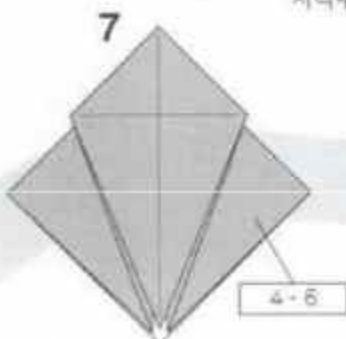

반대편도 4-5를 반복해주세요.

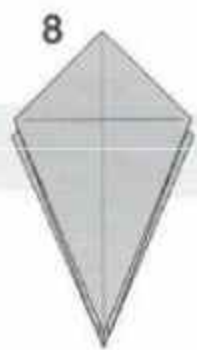

17

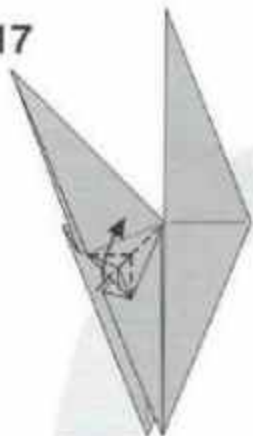

표시된 선을 따라 접어주세요.

18



16을 다시 펼쳐주세요.

20



뒷쪽으로 접어주세요.

19

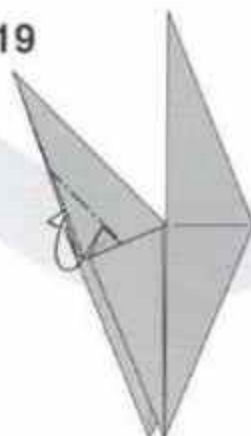

안쪽으로 접어주세요.

16



바깥쪽에 맞춰 접어주세요.

14



안쪽으로 펼쳐 놓은 뒤 접어주세요.

13



아래로 접었다 펴주세요.

15

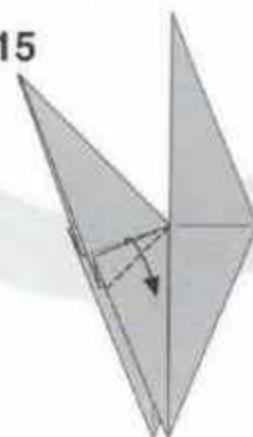

접어 내리세요.

12

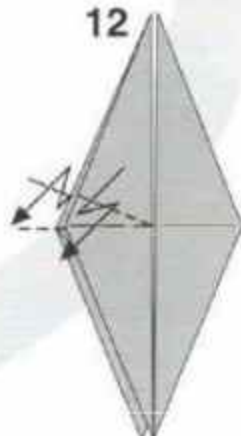

표시된 선을 따라 안쪽으로 계단접기 해주세요.

9



선에 맞춰 접었다 펴주세요.

10

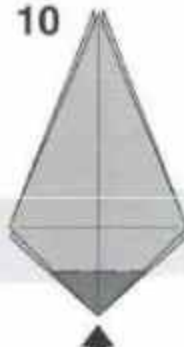

항을 접기 (Open sink)

11



앞뒤의 종이를 접어 내리세요.

21

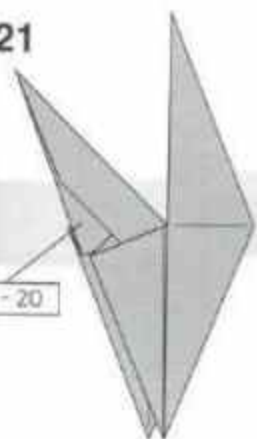

13-20

반대쪽도 13-20을 반복해주세요.

22

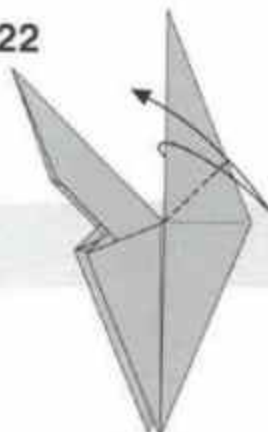

표시된 선을 따라
접었다 펴주세요.

23

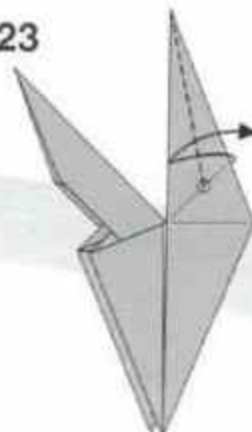

표시된 부분까지만
반으로 접었다 펴주세요.

24

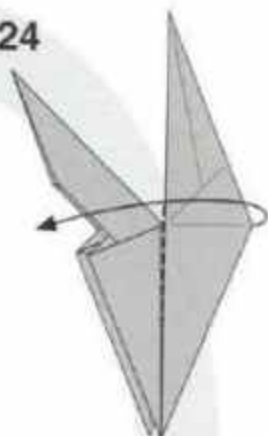

한장만
반대쪽으로 넘겨주세요.

27

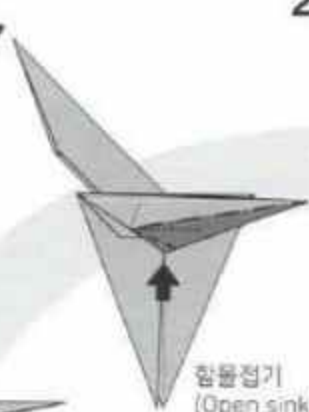

침몰집기
(Open sink)

26

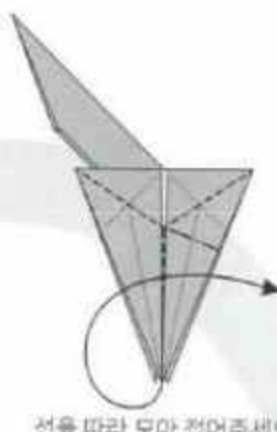

선을 따라 모아 접어주세요.

25

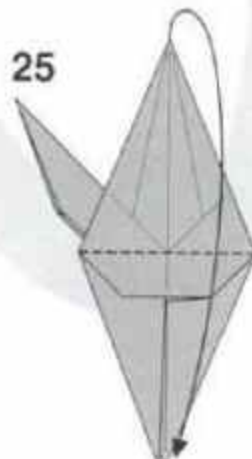

접어 내리세요.

28

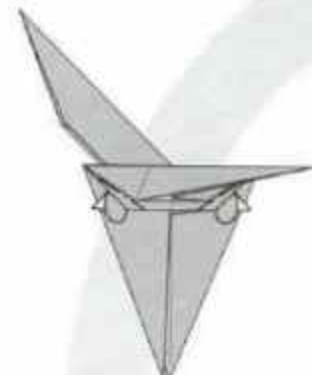

뒷쪽으로 접어주세요.

31

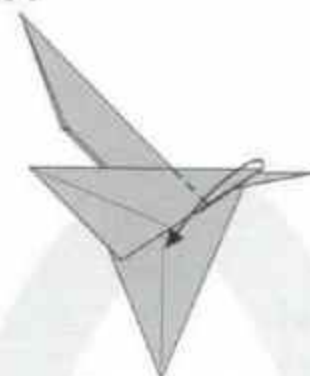

표시된 선을 따라
접어 내리세요.

29

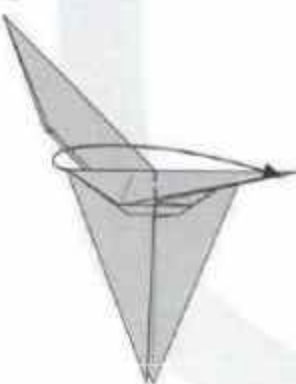

30



표시된 선을 따라
접어 올리세요.

32

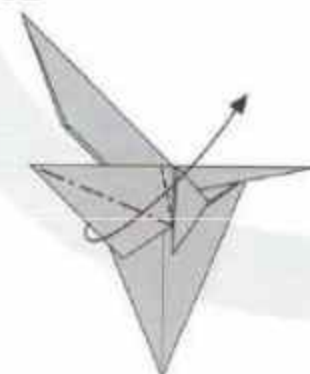

표시된 선을 따라
반으로 접어 올리세요.

41

30-40



반대쪽도 30-40을 반복해주세요.

42

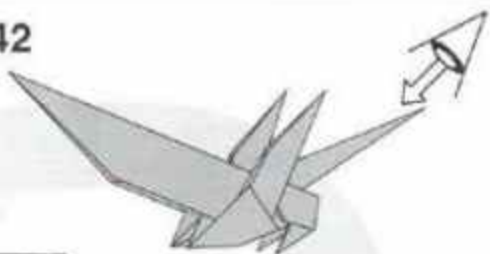

꼬리 끝부분을 좌우세요.

44



끝부분에 맞춰 겹쳐 내리세요.

43



40



안쪽으로 접어주세요.

38

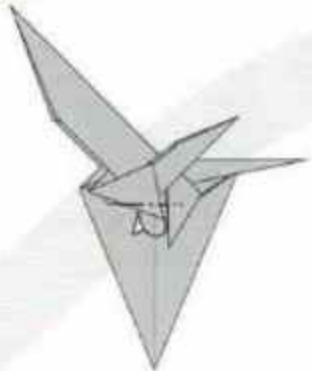

안쪽으로 접어주세요.

37

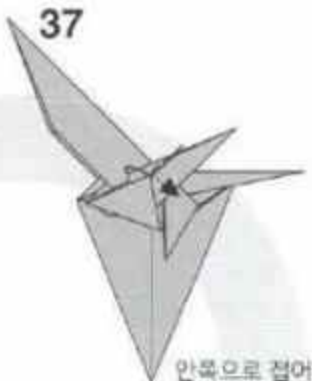

안쪽으로 접어주세요.

39

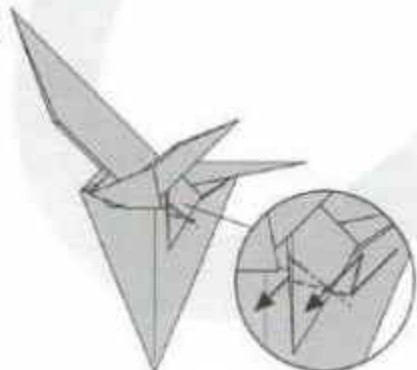

안쪽으로 계단접기 해주세요.

36

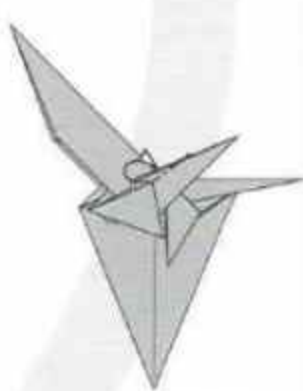

안쪽으로 접어주세요.

33

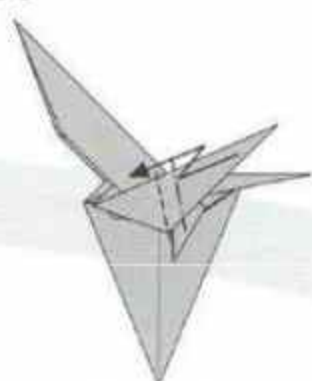

표시된 선을 따라 계단접기 해주세요.

34

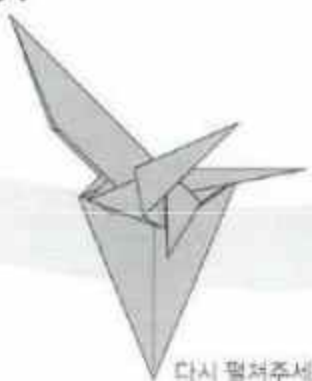

다시 펼쳐주세요.

35

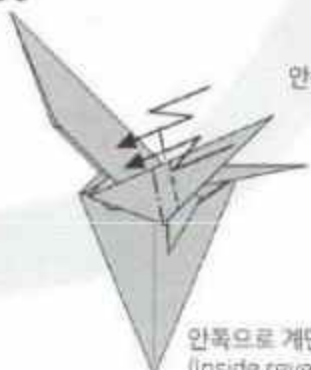

안쪽으로 계단접기 해주세요. (inside reverse fold in and out)

45



다시 전체를 봐주세요.

46

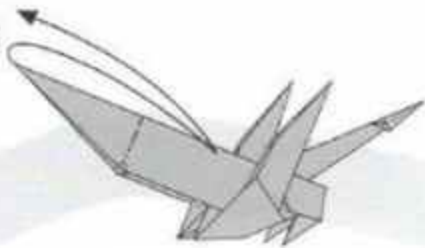

표시된 부분에 맞춰
끝부분만 앞으로 펴주세요.

47

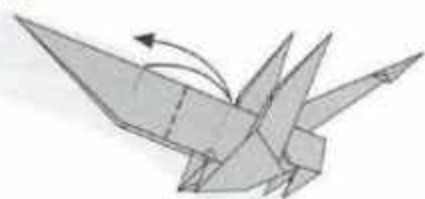

46의 선과 표시된 부분을
반으로 접었다 펴주세요.

49



반대쪽도 반복해주세요.

48



선을 따라 바깥쪽으로
계단접기 해주세요.

50

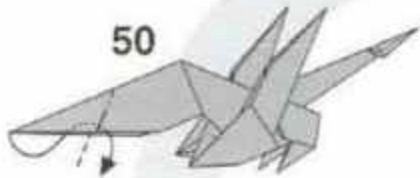

안쪽으로 접어주세요.

51

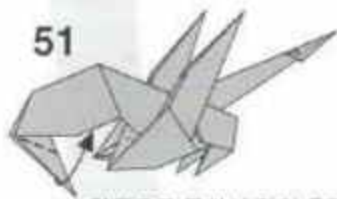

한쪽으로 몰아서 겹쳐 올려주세요.

54



완성

52



다시 한쪽으로 몰아서 접어 올려주세요.

53



전체적으로 둥글게 다듬어주세요.

다이너소어

Dinosaur

- Creator : 장용익(Jang Yong Ik)
- Diagram : 장용익(Jang Yong ik)
- Size : 35cm x 35cm

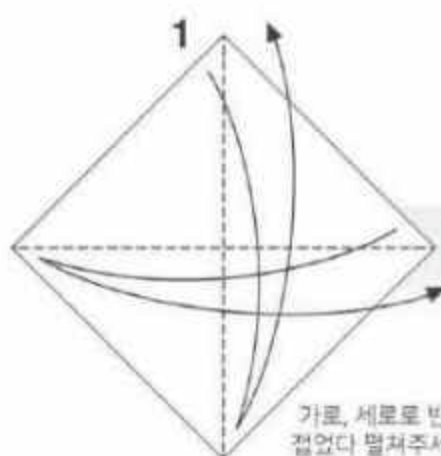
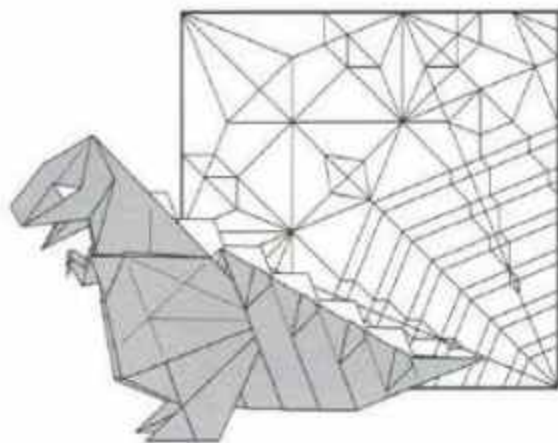

가로, 세로로 반을
접었다 펼쳐주세요.

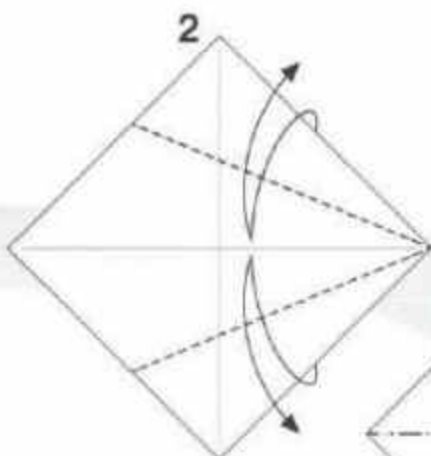

22.5°로 접었다
펼쳐주세요.

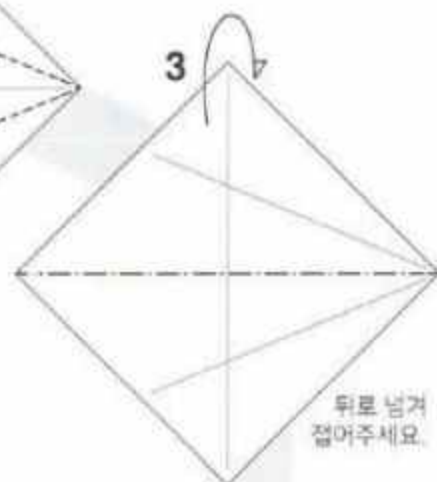

뒤로 넘겨
접어주세요.



선과 선 사이를
반으로 접었다
펼쳐주세요.
(6등분)

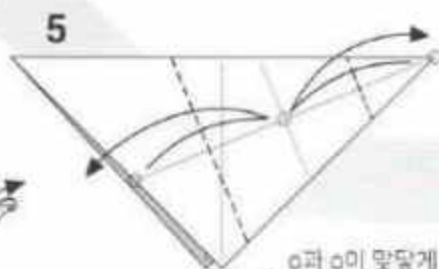

o과 o이 맞닿게
접었다 펼쳐주세요.
(4등분)

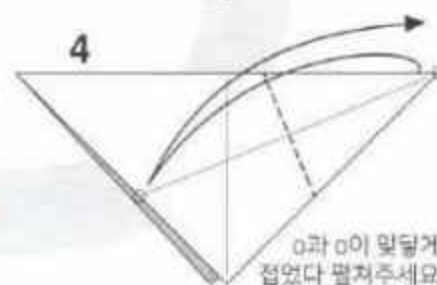

o과 o이 맞닿게
접었다 펼쳐주세요.

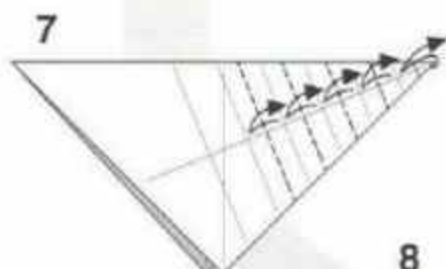

선과 선 사이를
반으로 접었다
펼쳐주세요.
(10등분)



선과 선 사이를
반으로 접었다
펼쳐주세요.
(18등분)



뒷장을 위로 올려
펼쳐주세요.

18



접었다 펼쳐주세요.

19



접었다 펼쳐주세요.

17



접었다 펼쳐주세요.

16



접었다 펼쳐주세요.

15

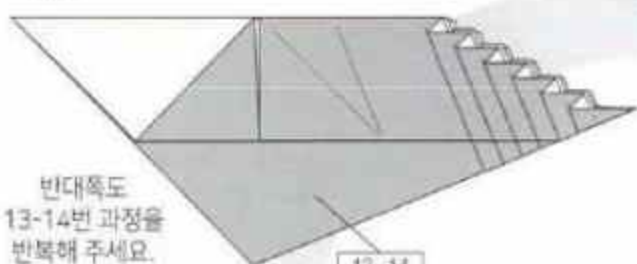

반대쪽도
13-14번 과정을
반복해 주세요.

13-14

13

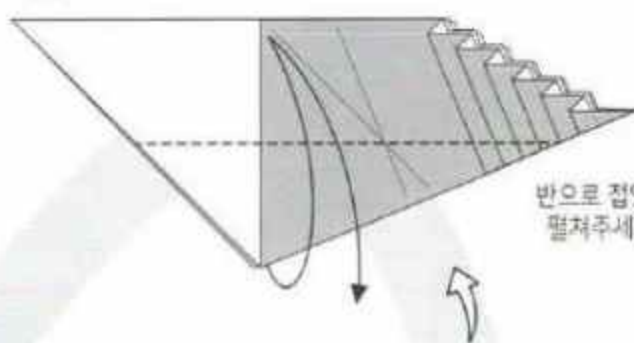

반으로 접었다
펼쳐주세요.

14

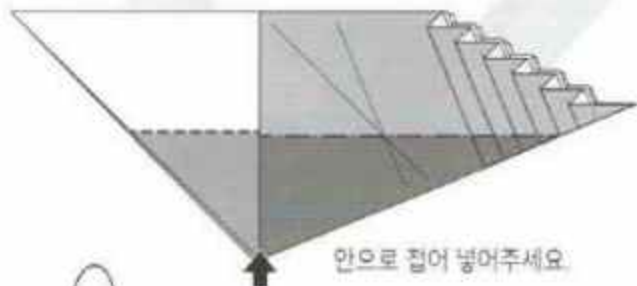

안으로 집어 넣어주세요.

12

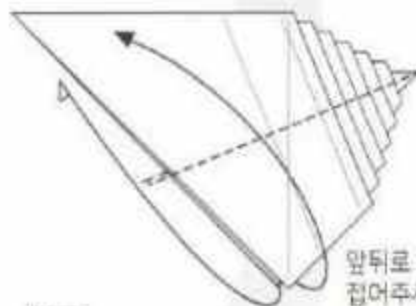

앞뒤로 돌려
집어주세요.

10



반으로 접는 동시에
계단접기 해주세요.

11



10번 과정을
다섯번 반복해 주세요.

20



겹었다 펼쳐주세요.

21

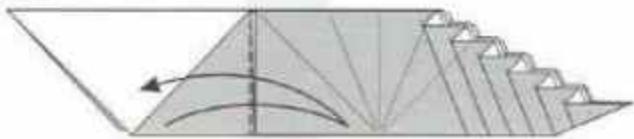

겹었다 펼쳐주세요.

22



겹었다 펼쳐주세요.

23

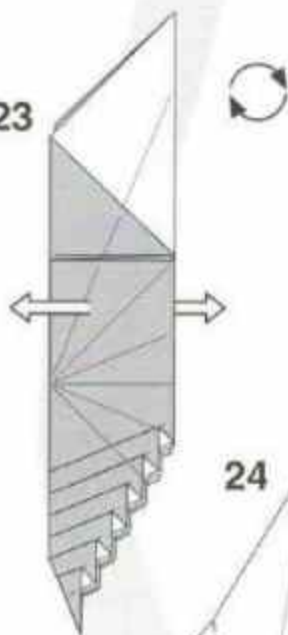

24

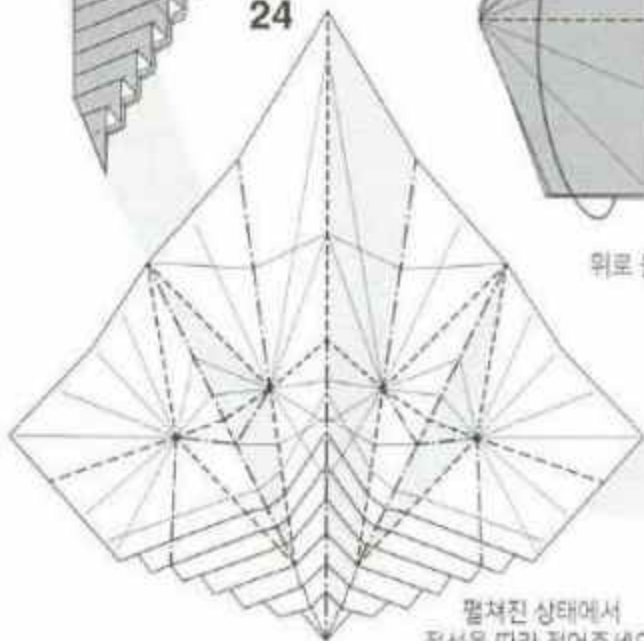

펼쳐진 상태에서
중선을 따라 접어주세요.

26

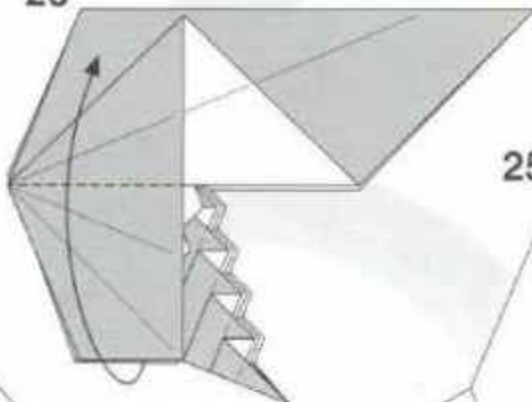

위면 올려 접어주세요.

25

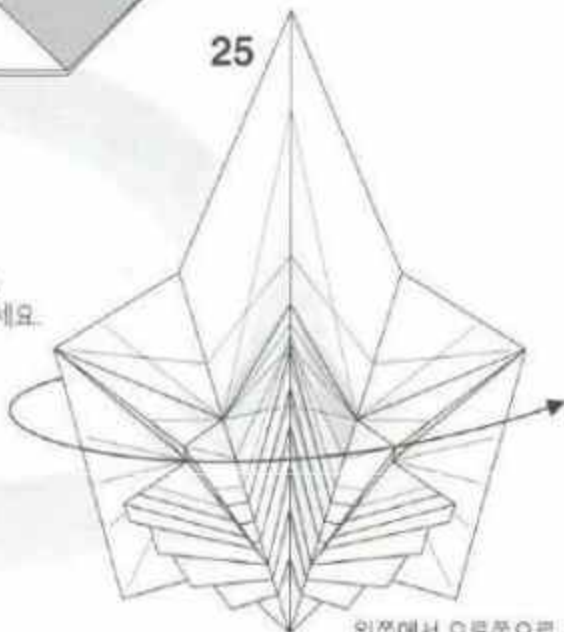

왼쪽에서 오른쪽으로
펼쳐놓으면 네모가
단정하게 접어주세요.

28

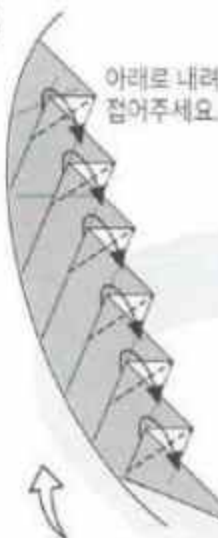

아래로 내려
접어주세요.

29

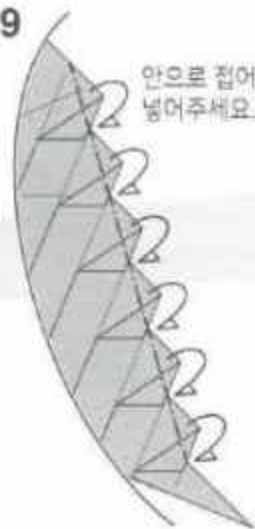

위면 올려
접어주세요.

27

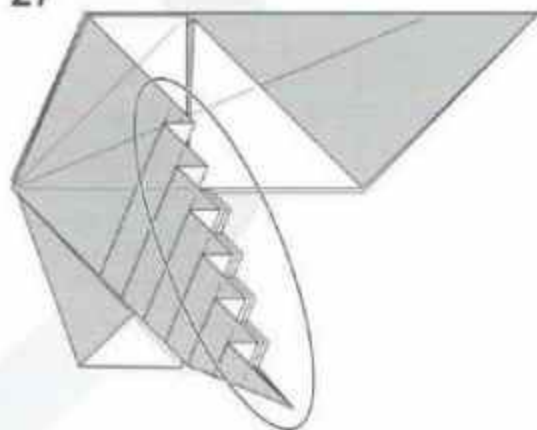

30

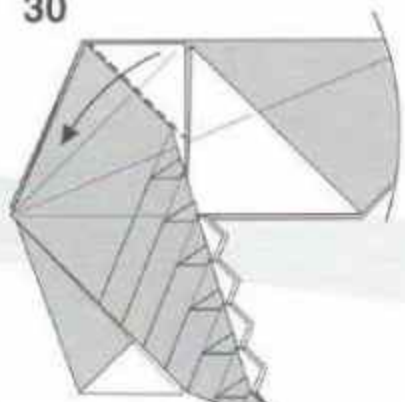

대각선으로 접어주세요.

31

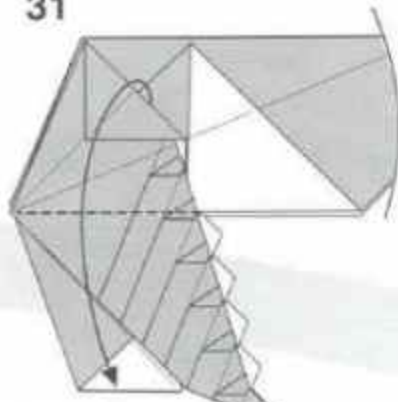

아래로 내려 접어주세요.

32

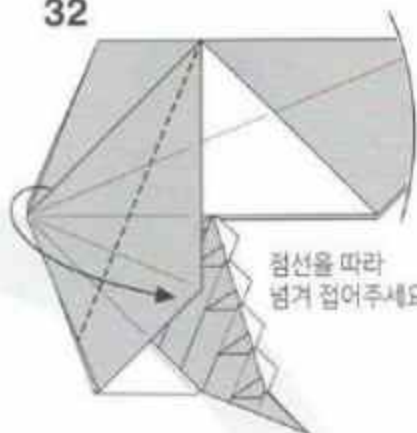

점선을 따라
앞쪽을 닫아주세요.

35

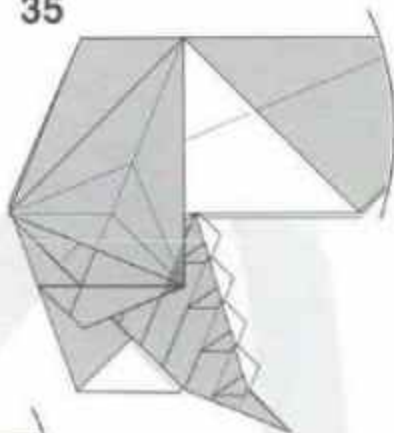

뛰어나온 부분을
뒤쪽 부분의 홈사이로
넣어서 고정해주세요.

33

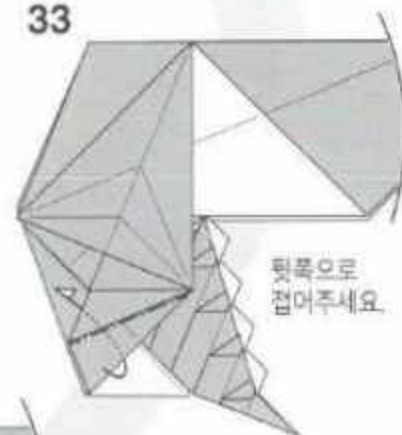

점선을
따라 닫아주세요.

36

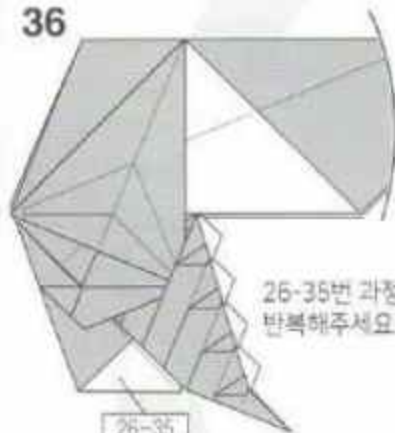

26-35번 과정을
반복해주세요.

26-35

34



뒷쪽으로
접어주세요.

37

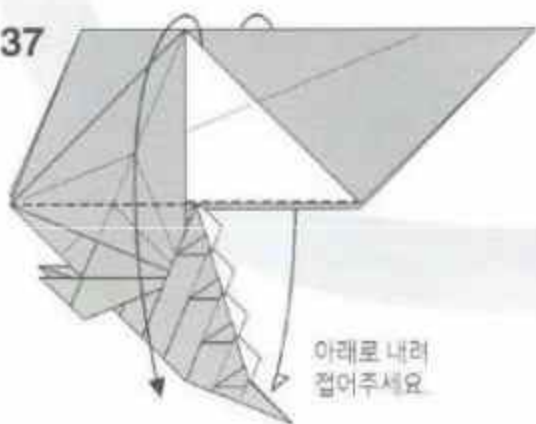

아래로 내려
접어주세요.

38

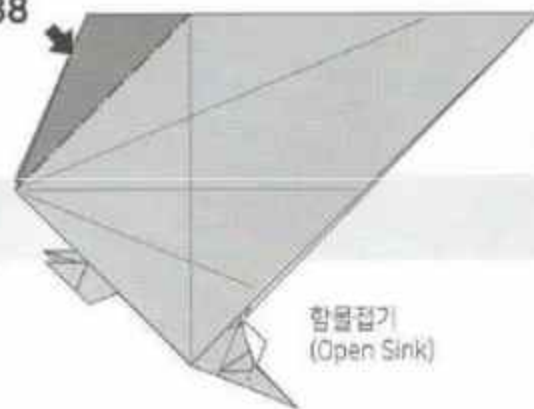

함몰집기
(Open Sink)

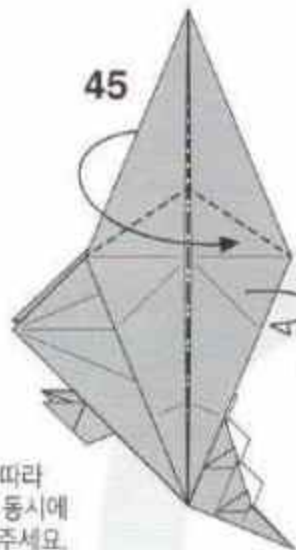

45

점선에 따라
꺾어 접는 동시에
뒤로 잡아주세요.



46

접었다 펼쳐주세요.



47

안쪽을 펼쳐서 위를
눌러 잡아주세요.



44

위로 펼쳐
잡아주세요.



43

중심선에 맞춰
접었다 펼쳐주세요.

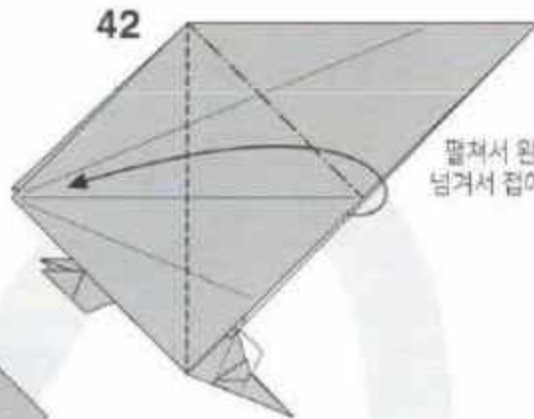

42

펼쳐서 안쪽으로
반고쳐 잡아주세요.

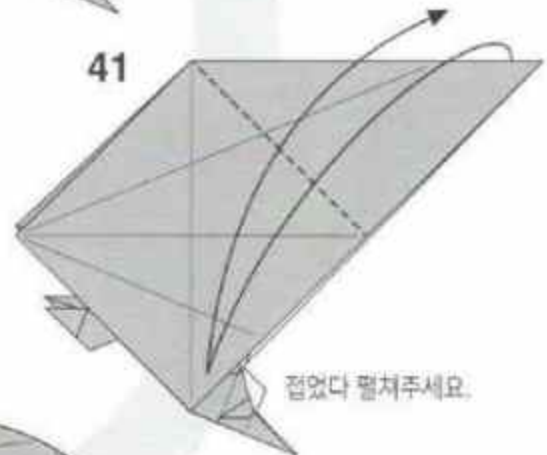

41

접었다 펼쳐주세요.

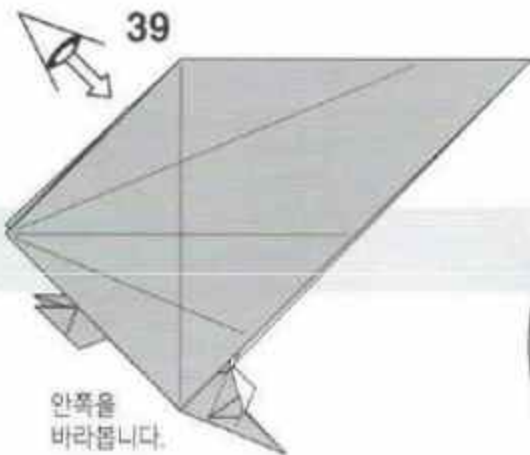

39

안쪽을
바라봅니다.

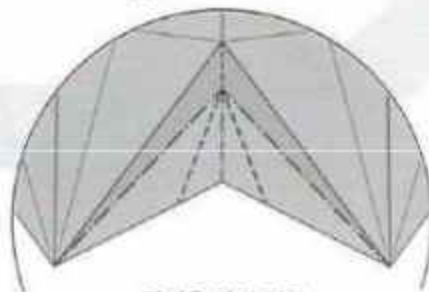

40

점선을 따라 접고
다시 납작하게 잡아주세요.

48



왼쪽으로
반겨 접어주세요.

49

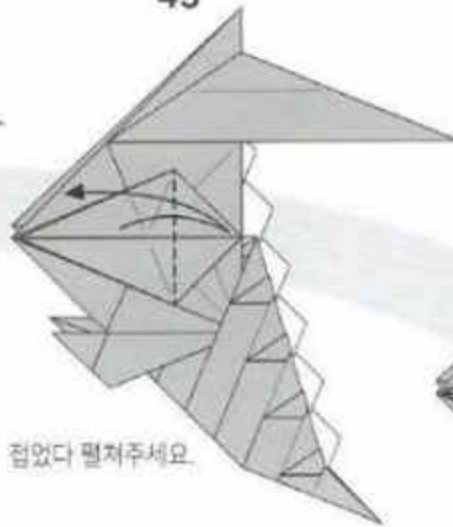

접었다 펼쳐주세요.

50

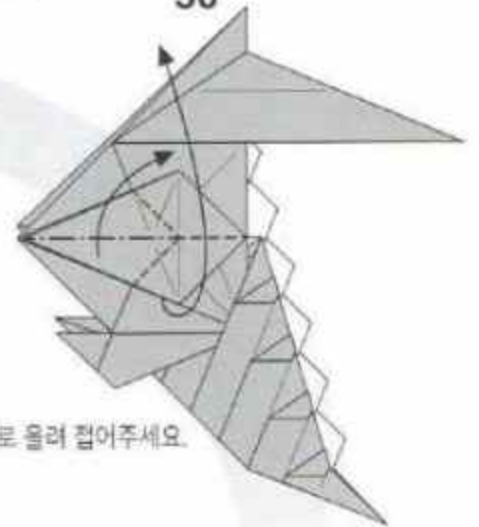

위로 올려 접어주세요.

53



안으로 접어 넣어주세요.

54



안으로 접어 넣어주세요.

52



안으로 접어 넣어주세요.

51

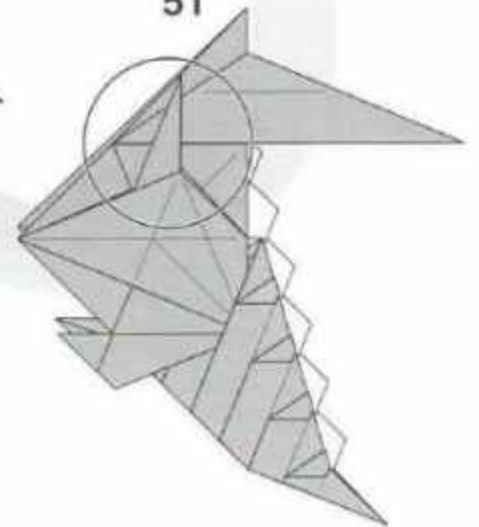

55

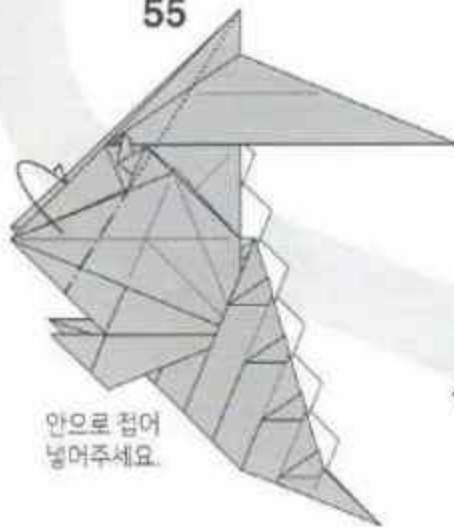

안으로 접어
넣어주세요.

56



안으로 접어
넣어주세요.

57



반대쪽도
46-56번 과정을
반복해주세요.

64

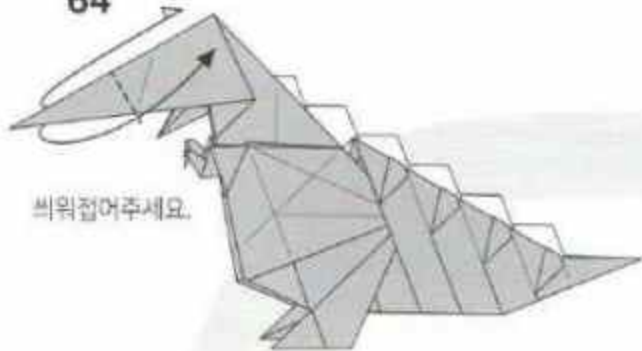

씩씩접어주세요.

65

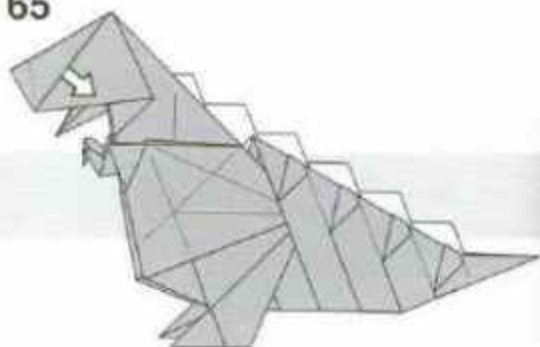

안쪽 부분을 바깥으로 꺼내주세요.

63

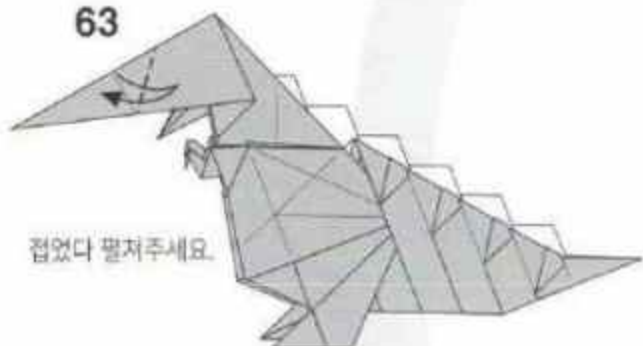

접었다 펼쳐주세요.

62

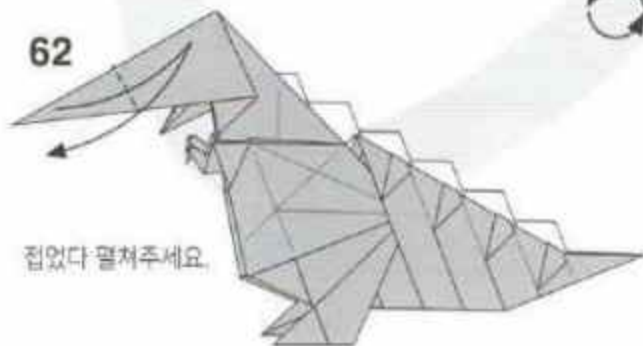

접었다 펼쳐주세요.

61



씩씩접어주세요.

58

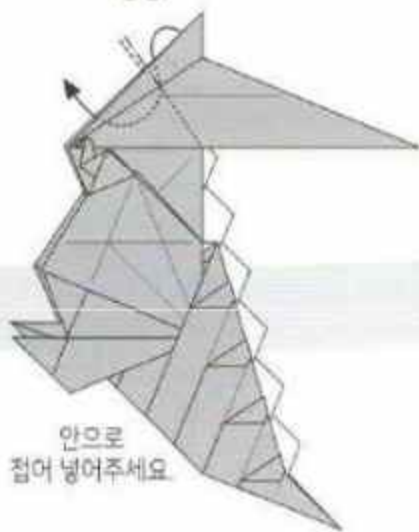

안으로
접어 넣어주세요.

59



안으로
접어 넣어주세요.

60

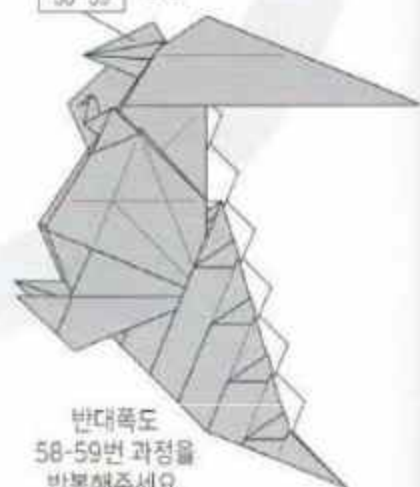

반대쪽도
58-59번 과정을
반복해주세요.

66

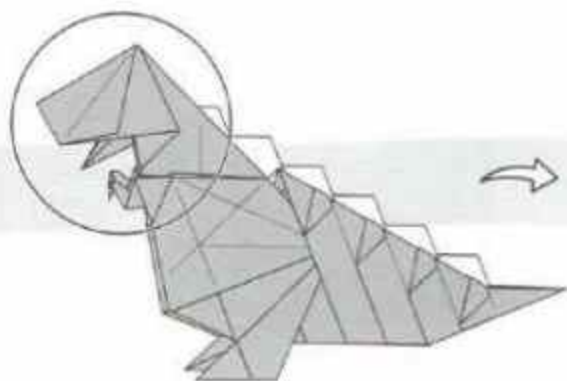

67

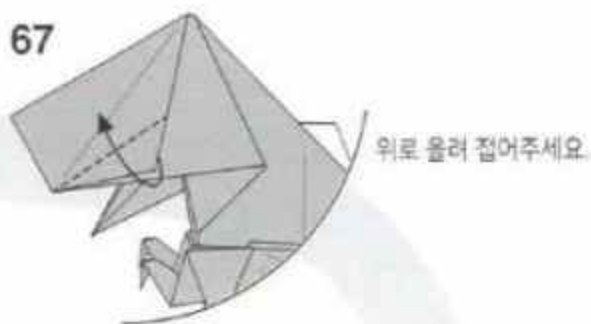

위쪽 올려 접어주세요.

68

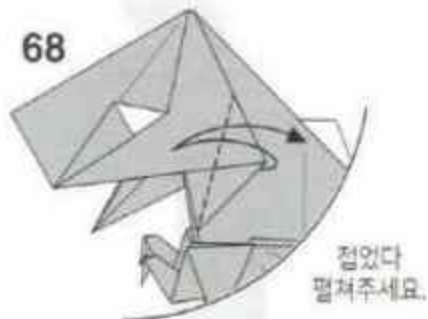

접었다
펼쳐주세요.

74

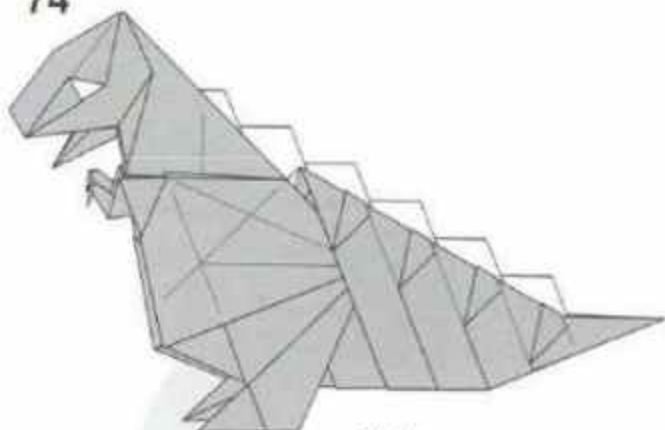

완성

69



안으로 접어
넣어주세요.

73



안쪽에서 겹쳐접어
고정해주세요.

70

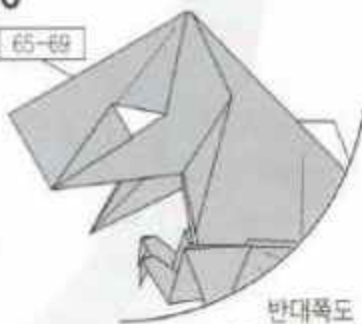

반대쪽도
65-69번 과정을
반복해주세요.

72



안으로 접어 넣어주세요.

71



비스듬히
접었다 펼쳐주세요.

태드래곤

TAE-DRAGON

- Creator : 유태용(Yoo Tae Yong)
- Diagram : 유태용(Yoo Tae Yong)
- Size : 30cm x 30cm

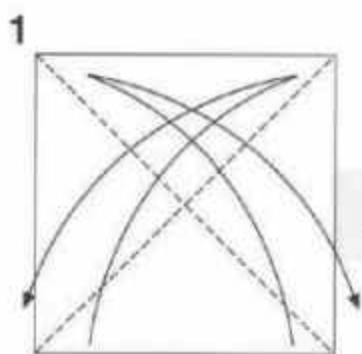
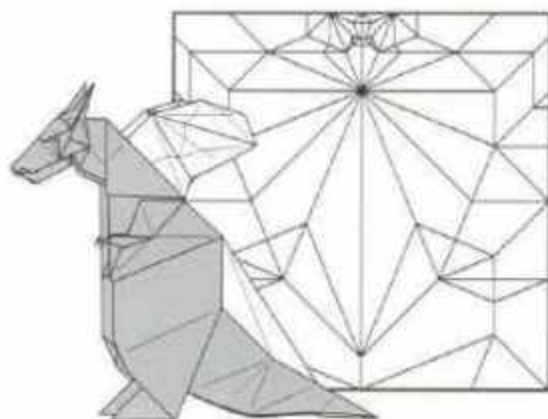

대각선으로
접었다 펴주세요.

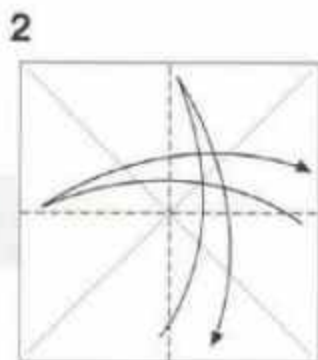

반으로 접었다 펴주세요.

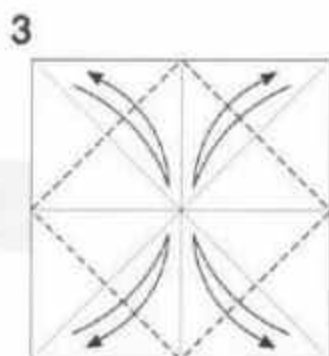

중심에 맞춰 접었다 펴주세요.

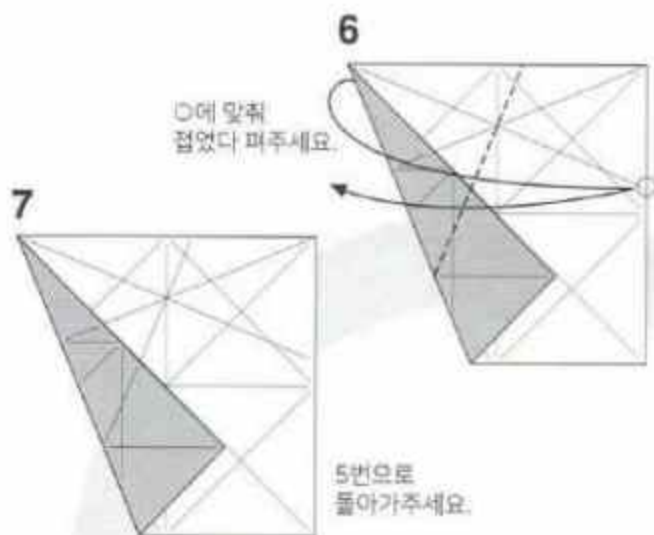

O에 맞춰
접었다 펴주세요.

5번으로
돌아가주세요.

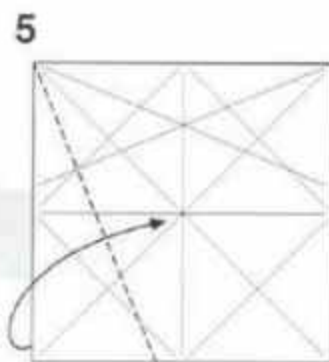

선에 맞춰 위로 접어주세요.

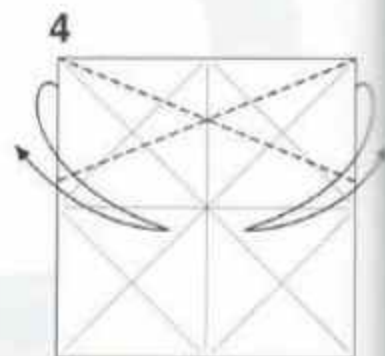

선에 맞춰 접었다 펴
주세요.

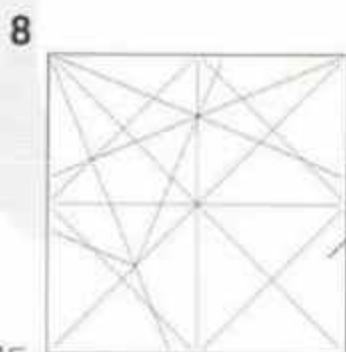

반대쪽도
5-7을 반복해주세요.

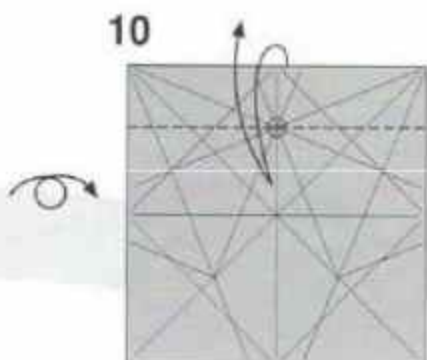
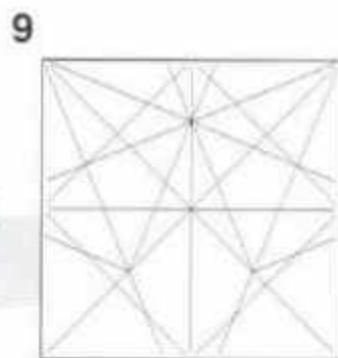

O에 맞춰
접었다 펴주세요.

19

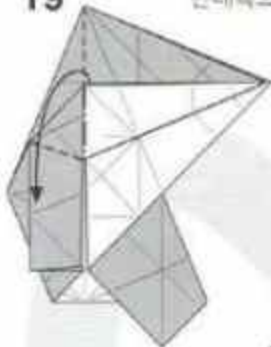

앞쪽을 O로 접으면서
뒤쪽을 O로 접으세요.

21

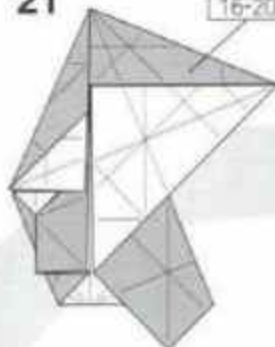

16-20

반대쪽도 16-20을
반복해주세요.

22



안쪽 중이를 밖으로
펼주세요.

20

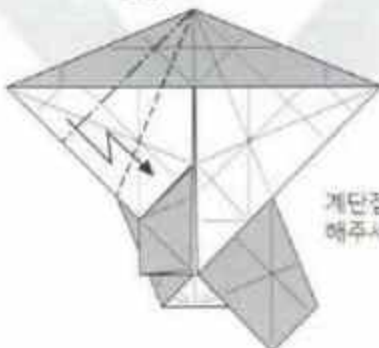

계단접기
해주세요.

18



계단접기
해주세요.

15

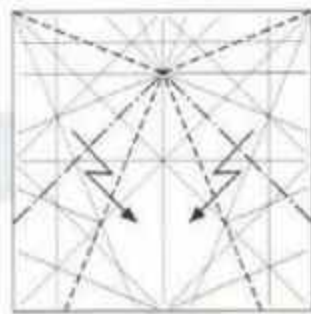

계단접기를
하면서 모아
접어주세요.

16

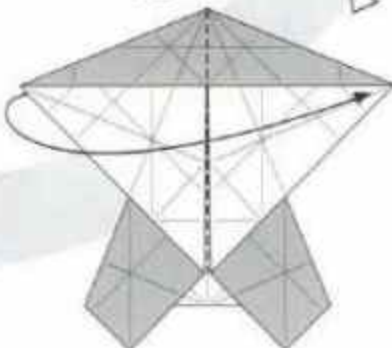

반대쪽으로도
접어주세요.

17

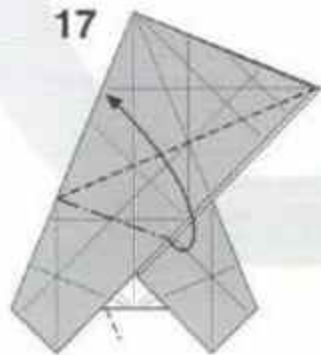

위로 펼쳐
접어주세요.

14

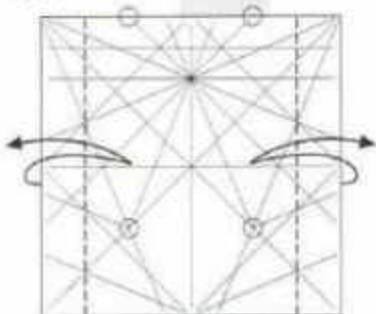

○에 맞춰
접었다 펴주세요.

11

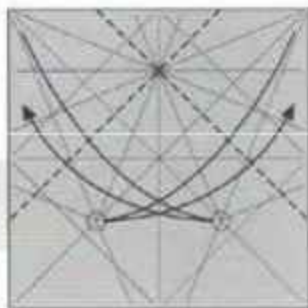

○에 맞춰
접었다 펴주세요.

12

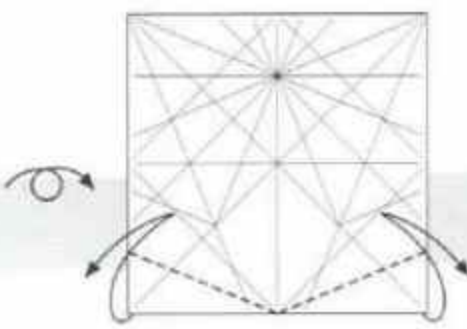

선에 맞춰
접었다 펴주세요.

13

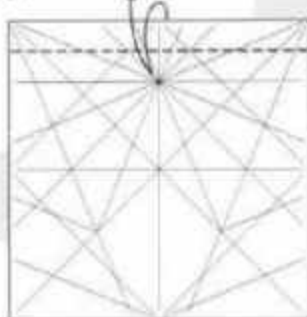

반으로
접었다 펴주세요.

23

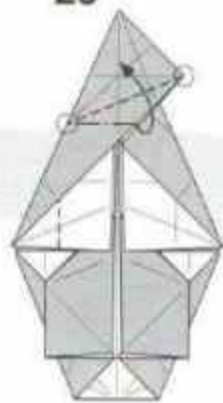

○를 잇는 선으로
계단접기 해주세요.

24

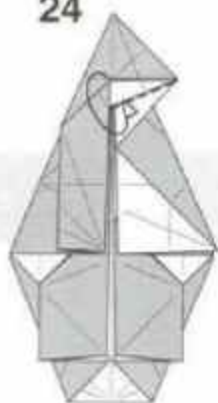

뒤로 뒤집어 주세요.

25



반대쪽으로 접어주세요.

26

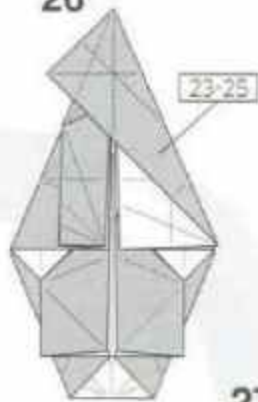

반대쪽도 23-25를
반복해주세요.

27

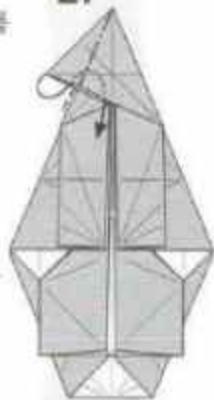

안쪽으로
접어주세요.

30



앞선과 같이
안쪽 쪽이름 밖으로
펼주세요.

29

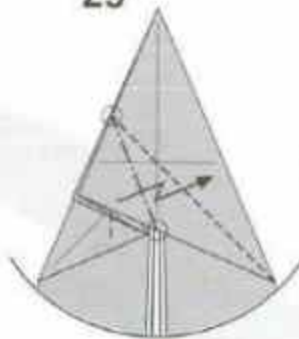

○를 잇는 선으로
계단접기 해주세요.

28

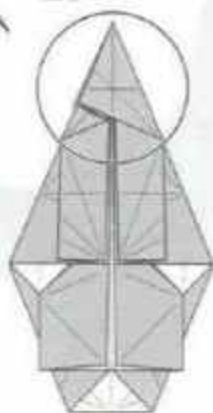

31

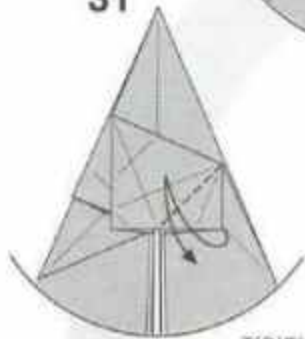

접었다 펴주세요.

32

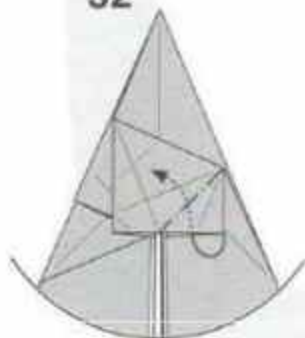

안쪽으로 접어주세요.

33

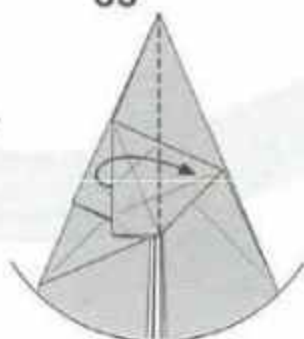

반대쪽으로 접어주세요.

34



반대쪽도 29-33을
반복해주세요.

35

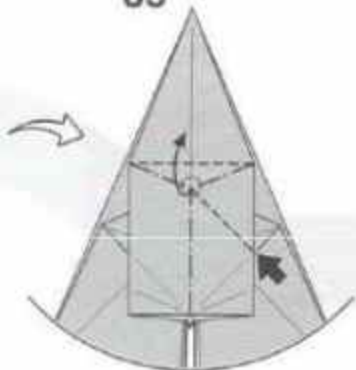

○를 위로 당겨
올려 접어주세요.

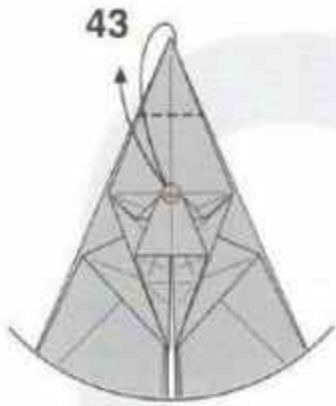

O에 맞춰
접었다 펴주세요.

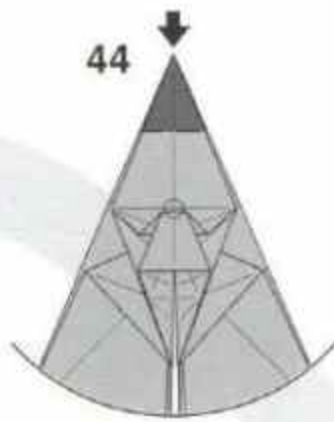

함몰접기 (Open sink)

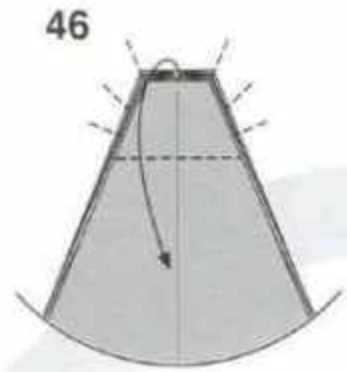

아래로 펼쳐 눌러
접어주세요.

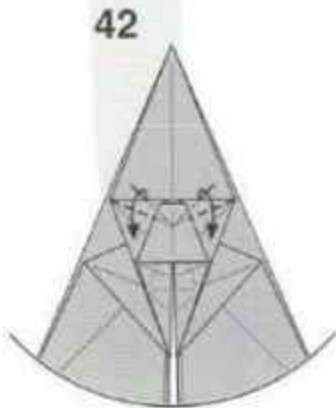
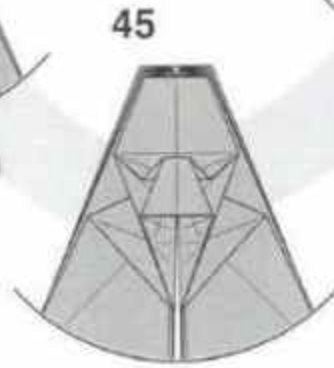

양쪽 다 계단접기
해주세요.

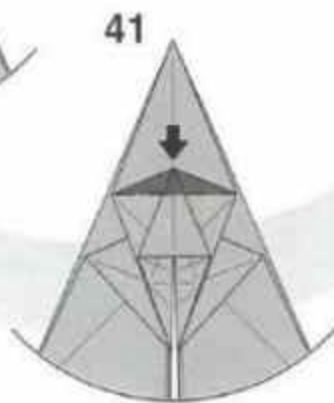

함몰접기 (Open sink)

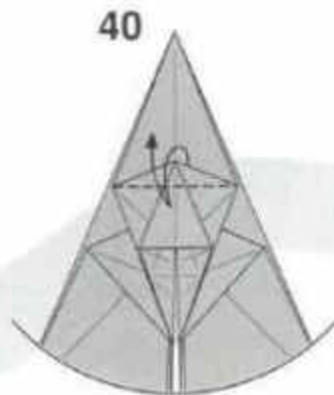

접었다 펴주세요.

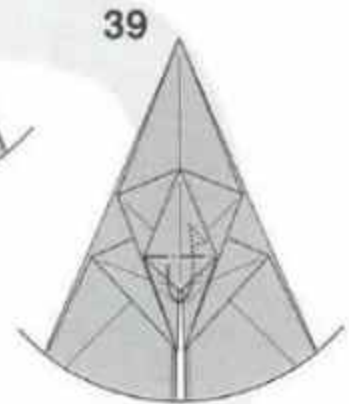

안쪽으로 넣어
접어주세요.

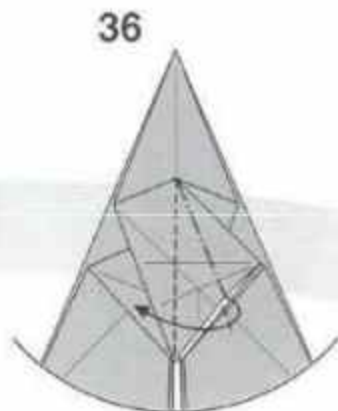

펼쳐 눌러 접어주세요.

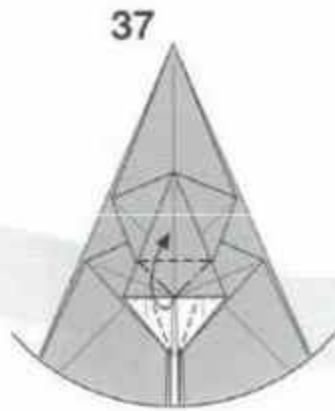

위로 펼쳐 눌러 접어주세요.

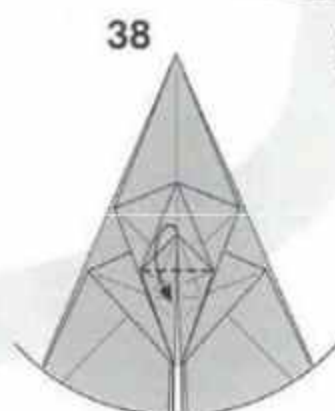

아래로 접어주세요.

47

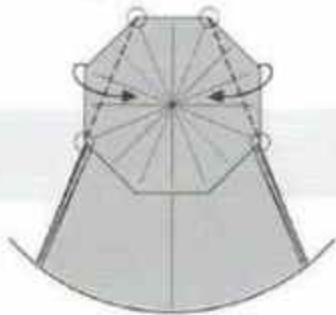

○에 맞춰 접어주세요.

48

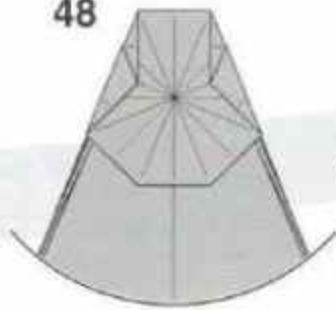

49

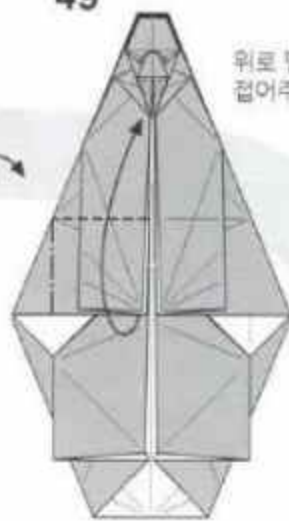

위쪽 펼쳐 놓고
접어주세요.

52

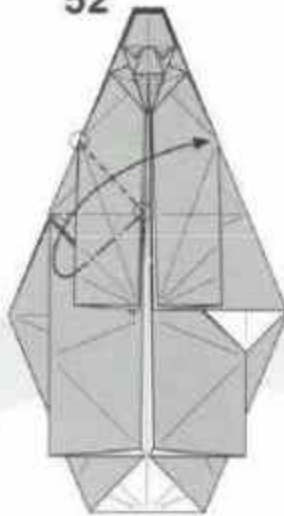

○ 부분을
펼쳐 접어주세요.

51

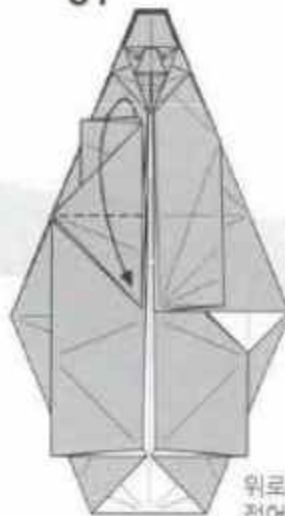

○ 부분을
펼쳐 접어주세요.

50

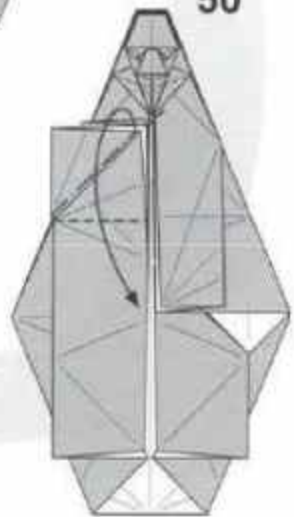

아래쪽 펼쳐 놓고
접어주세요.

53



올려 접었을 때
○ 부분이
딱 맞아야 합니다.
52번으로 돌아가주세요.

54

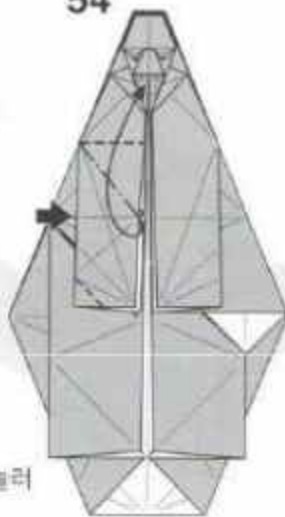

안쪽을 펼쳐 놓고
접어주세요.

55

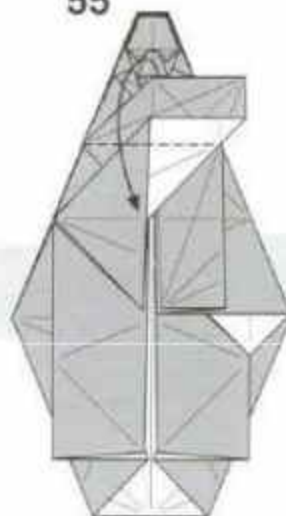

아래쪽 접어주세요.

56

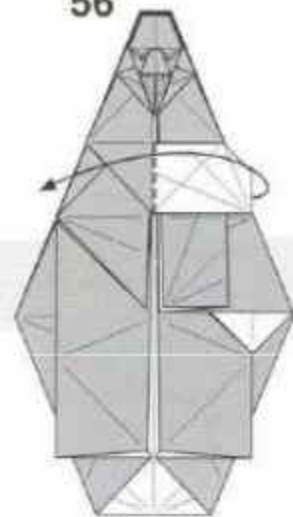

반대쪽으로 접어주세요.

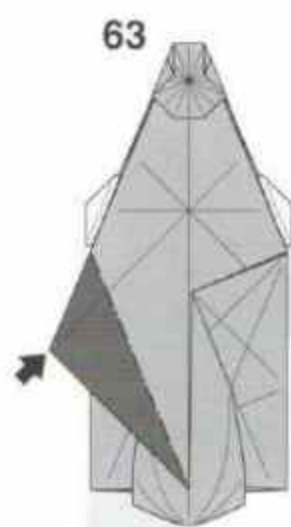

63
함몰시키기 (Open sink)

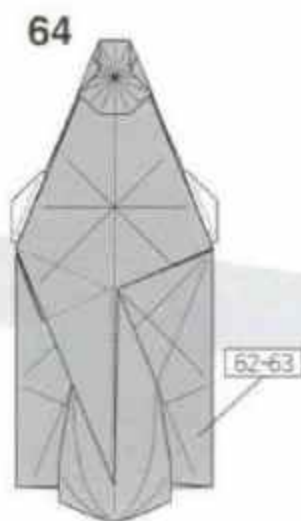

64
반대쪽도 62-63을 반복해주세요.

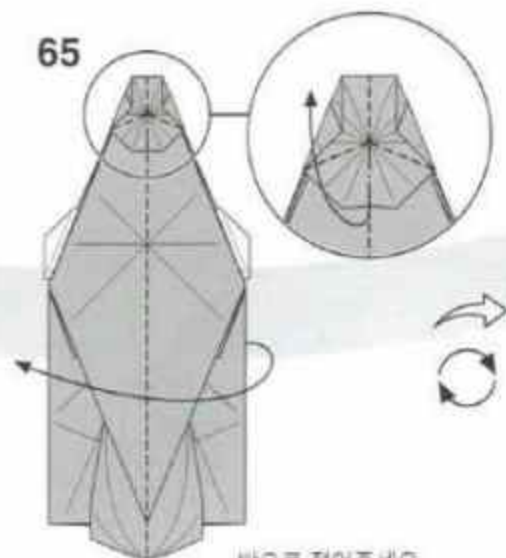

65
반으로 접어주세요.

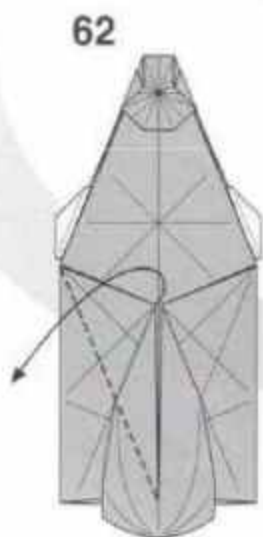

62
아래로 접어주세요.



61
반대쪽으로 접어주세요.

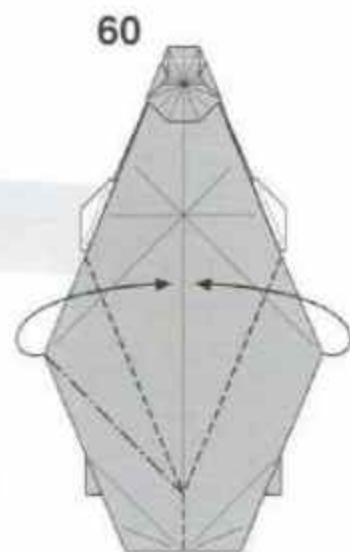

60
가운데로 모아
접어주세요.

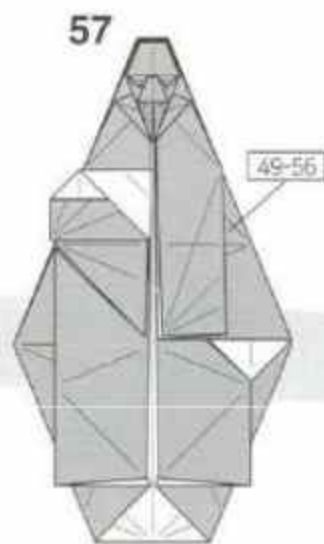

57
반대쪽도 49-56을
반복해주세요.

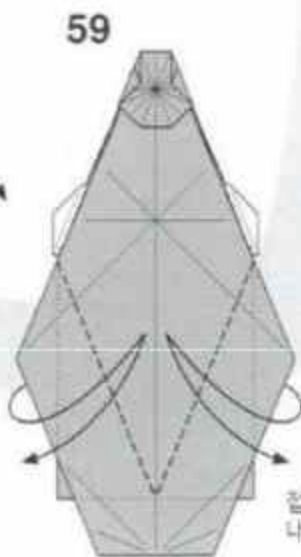
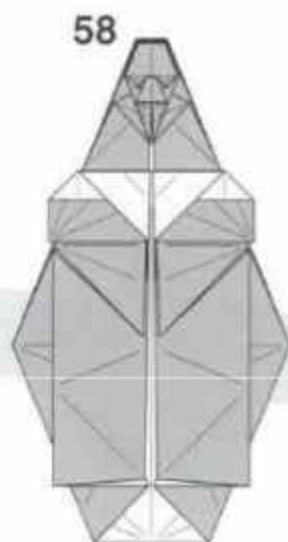

59
없었다면 손
대주세요.

66



양쪽 다 반대쪽으로
넘겨주세요.

67

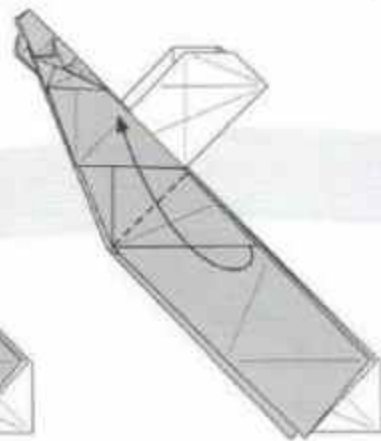

위로 올려 집어주세요.

68



○에 맞춰
집어주세요.

71

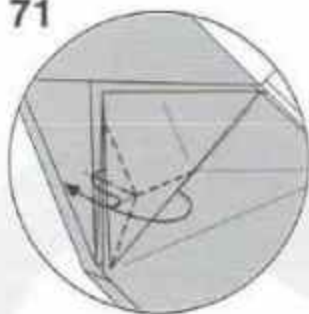

모아서 올려
집어주세요.

70

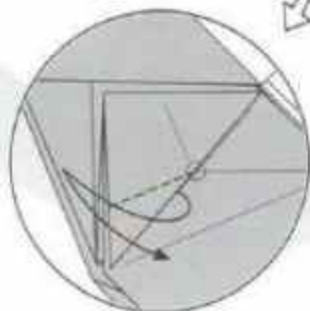

○ 주변에서
맞았다 따주세요.

69

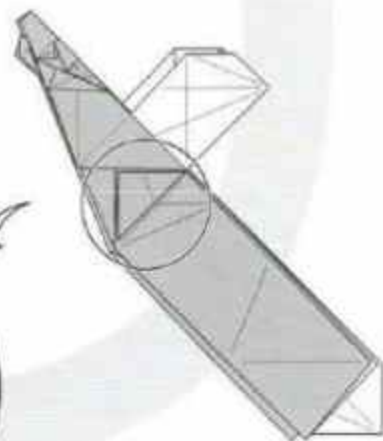

72

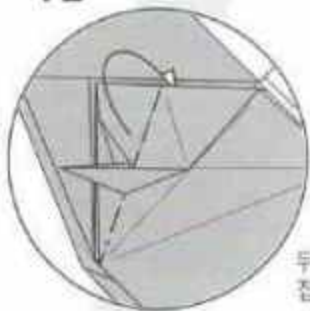

뒤로 넘겨
집어주세요.

75

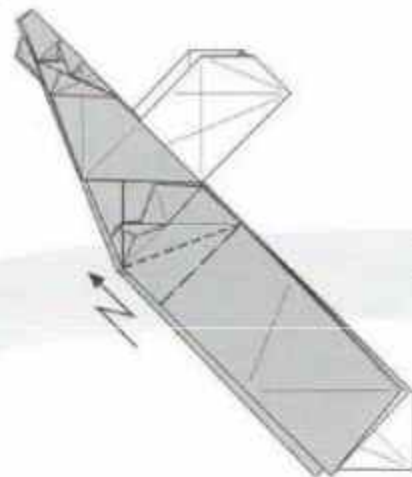

계단질기
해주세요.

73

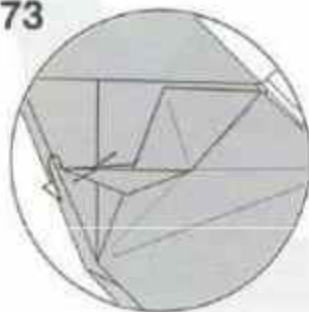

끝부분을 조금만
뒤집어 집어주세요.

74

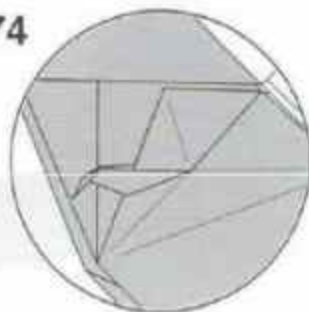

반대쪽도 67-73을
반복해주세요.

82

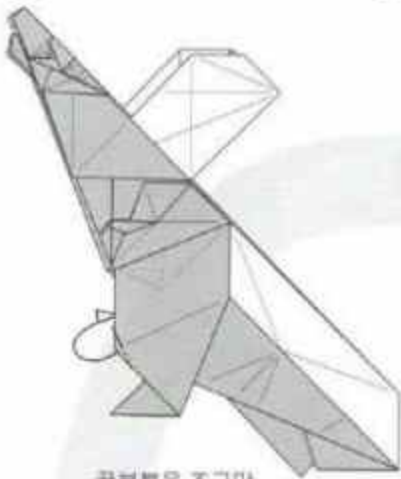

끝부분을 조금만
뒤로 잡아주세요.

83

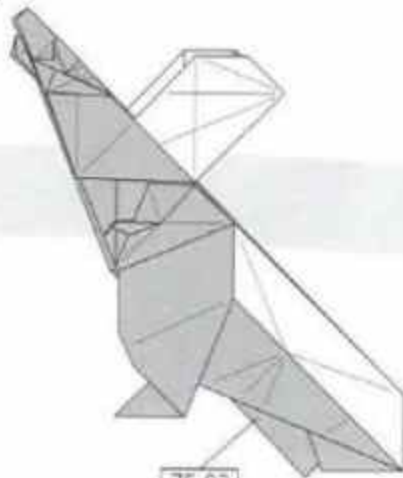

반대쪽도 75-82를
반복해주세요.

84

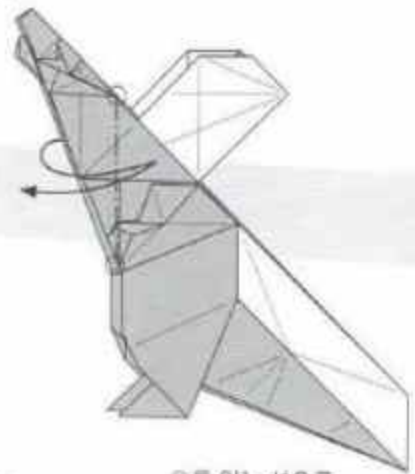

○를 잇는 선으로
잡았다 펴주세요.

81

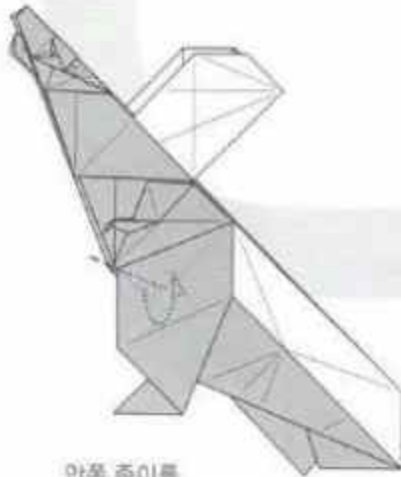

안쪽 양이를
펼쳐서 고정해주세요.

80

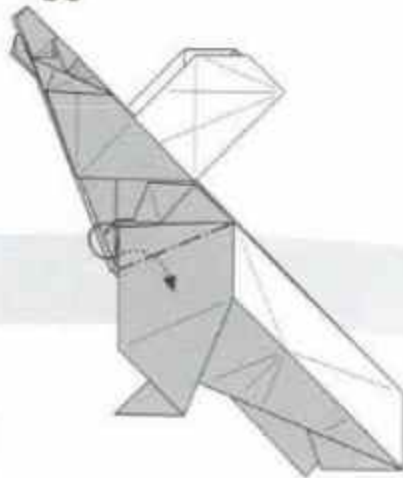

안쪽으로
잡아주세요.

79

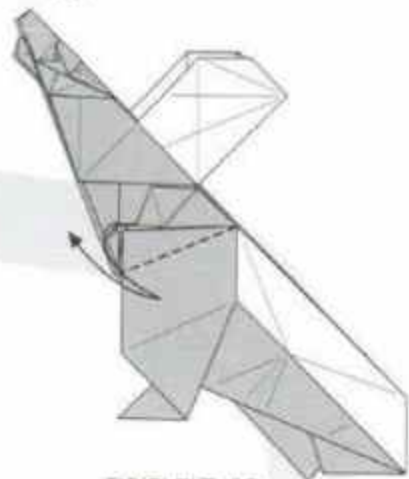

잡았다 펴주세요.

76

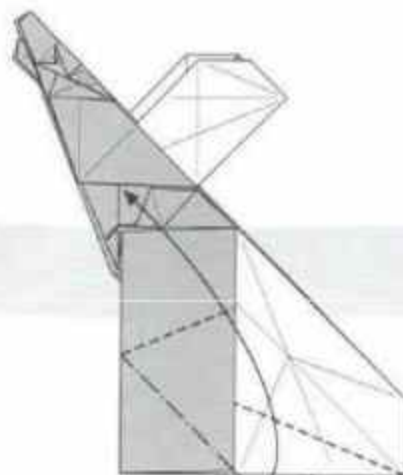

뒤로 밀쳐 눌러
잡아주세요.

77

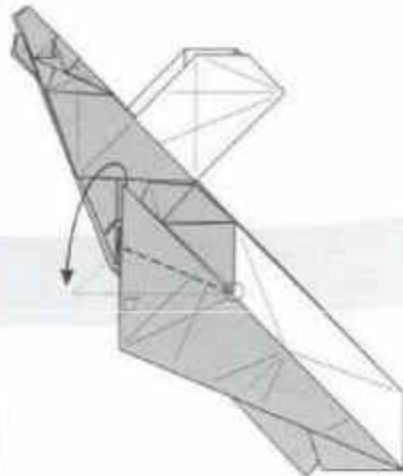

점선에 맞게 내려
잡아주세요.

78

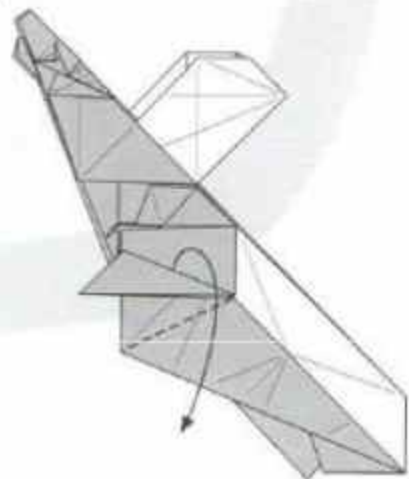

아래로 내려
잡아주세요.

85

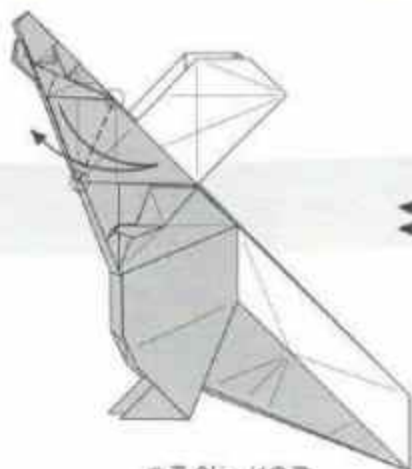

○를 잇는 선으로 접었다 펴주세요.

86

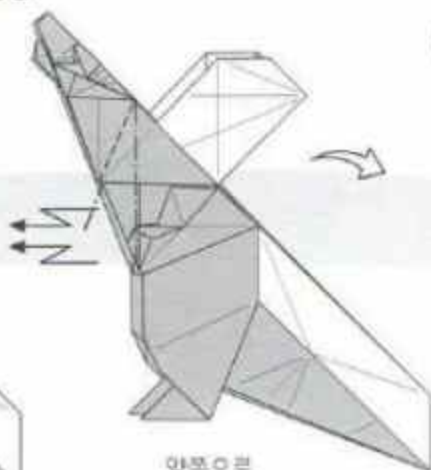

양쪽으로 계단접기 해주세요.

87



양쪽으로 계단접기 해주세요.

89



○를 잇는 선으로 접어주세요.

88

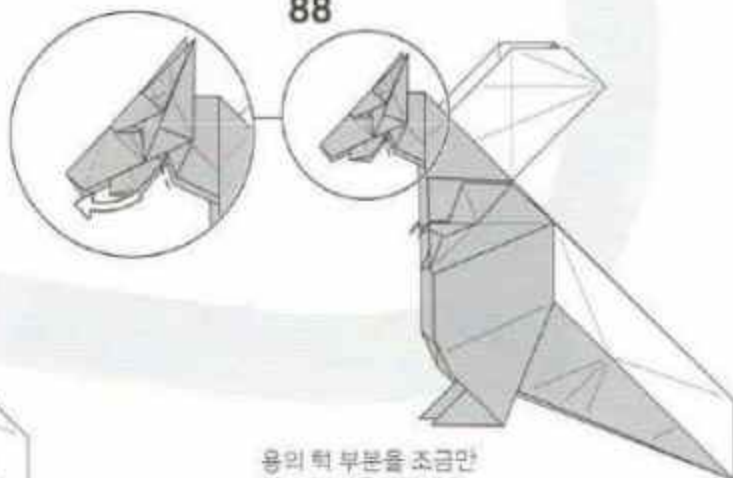

움의 턱 부분을 조금만 앞으로 기울어주세요.

90

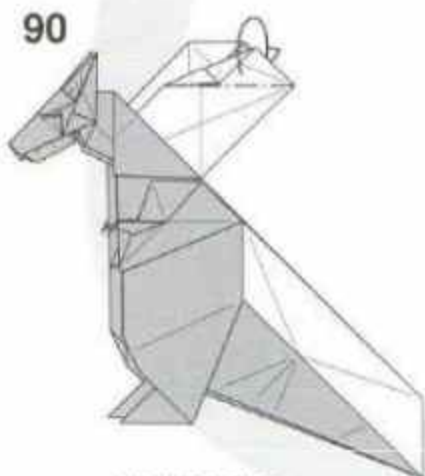

뒤로 접어주세요.

91

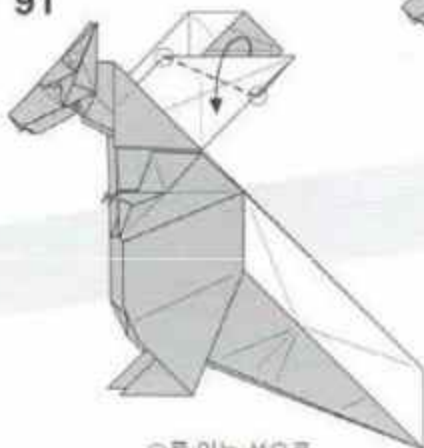

○를 잇는 선으로 접어주세요.

92

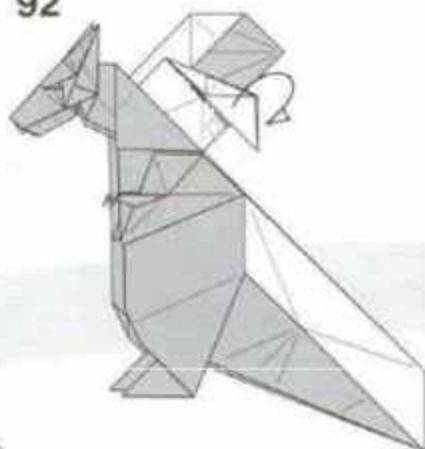

수직이 되도록 뒤로 접어주세요.

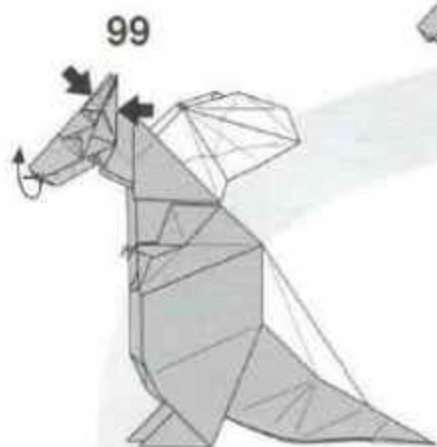

볼록하게 접어주고
코를 다듬어주세요.



○ 눈 위를 잘라서
수직으로 접어서
속편까지 잘라주세요.



코 밑 아래에 튀어나오는
부분을 안쪽으로
접어 넣으세요.

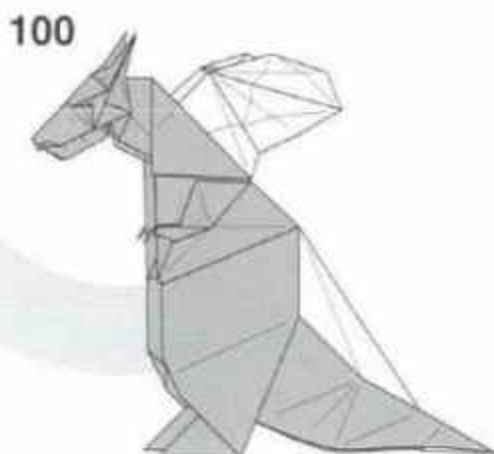

완성

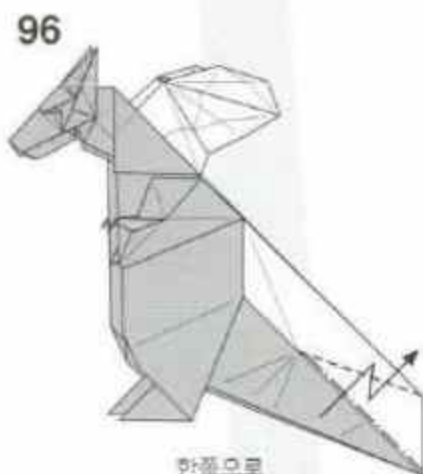

한쪽으로
계단접기 해주세요.

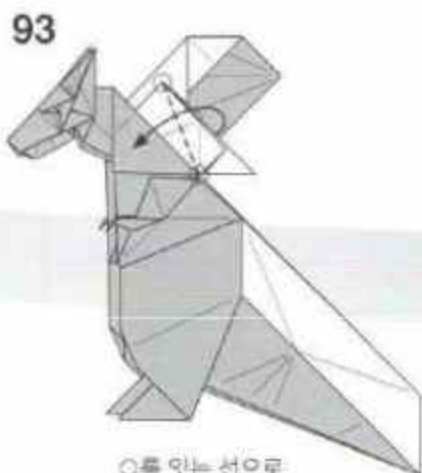

○ 눈 위를 잘라서
편의편을 잘라주세요.

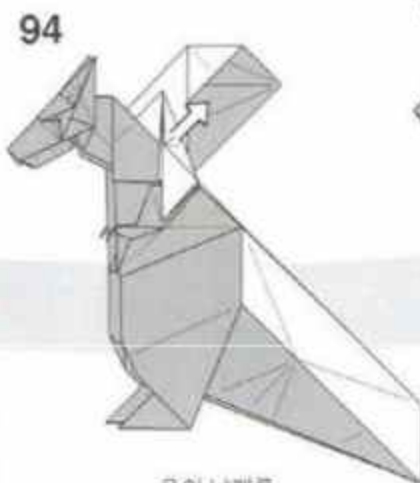

편의편을 잘라
속편에 붙여주세요.



면대쪽의 89-94쪽
부분을 잘라주세요.

혹등고래

Humpback Whale

- Creator : 박종우(Park Jong Woo)
- Diagram : 박종우(Park Jong Woo)
- Size : 25cm x 25cm

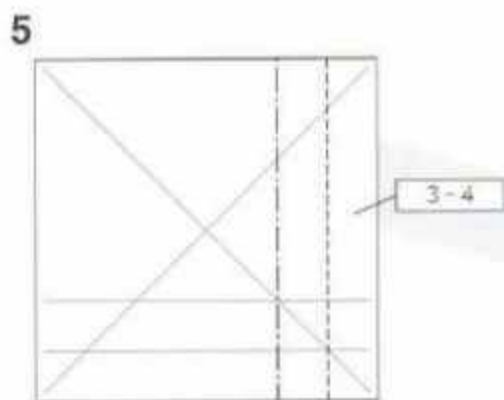
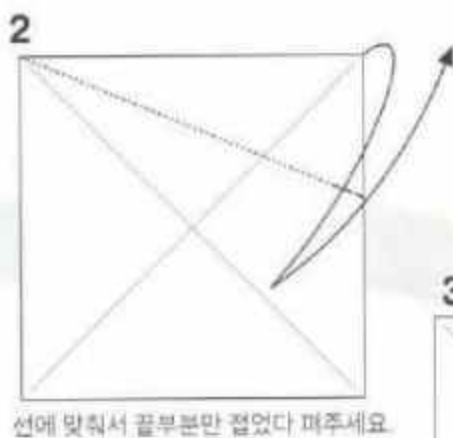
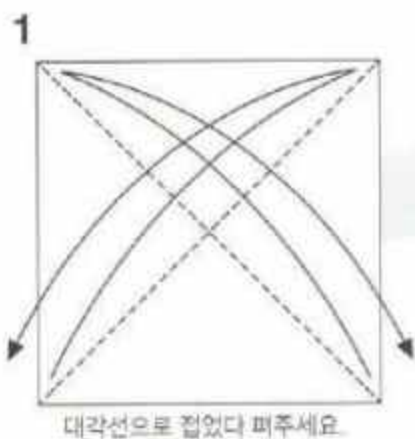
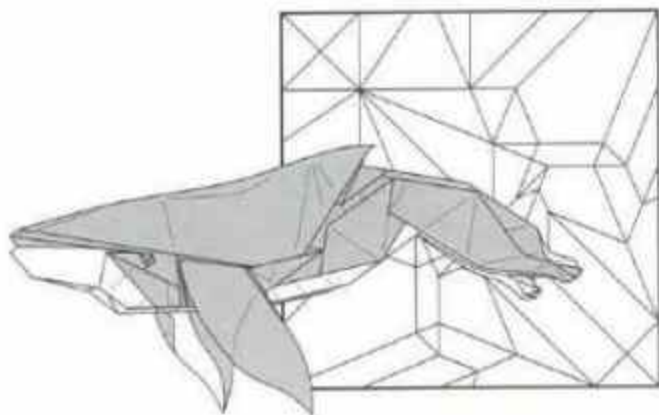

3-4를 반복해주세요.

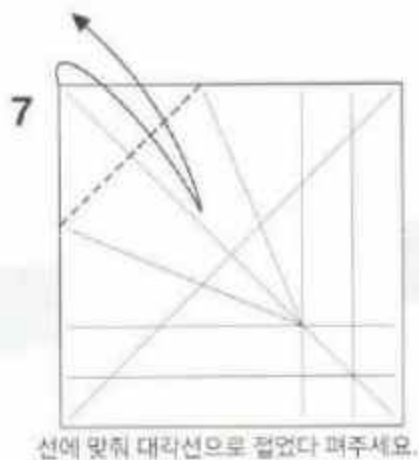
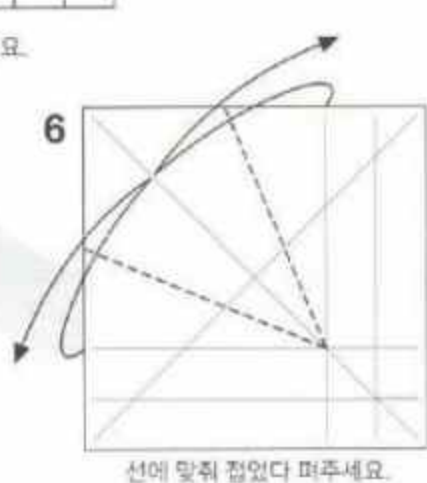
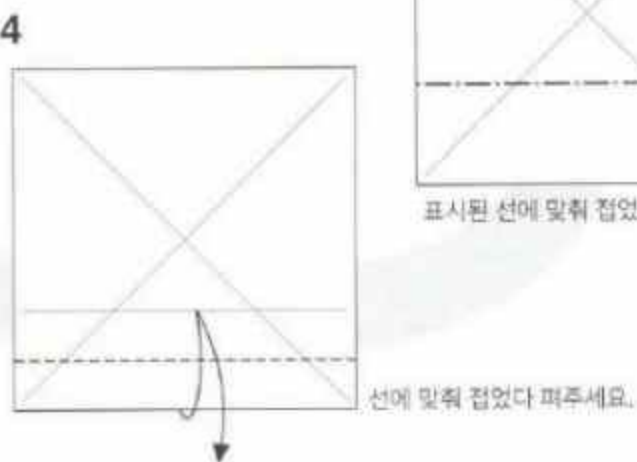

13

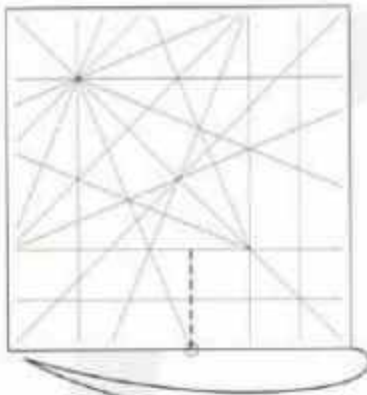

표시된 선에 맞춰 접었다 펴주세요.

14

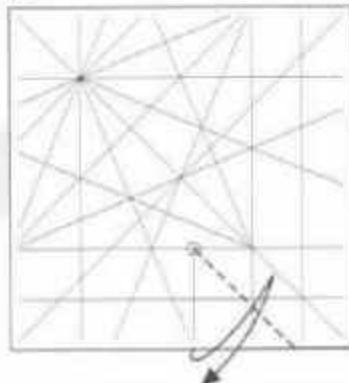

표시된 선에 맞춰 접었다 펴주세요.

15

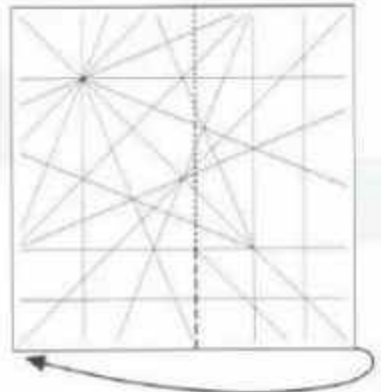

표시된 부분까지만 접어주세요.

12

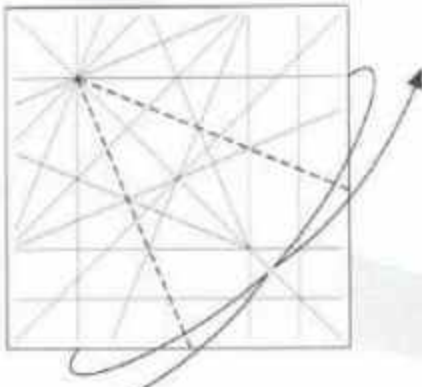

선에 맞춰 접었다 펴주세요.

11

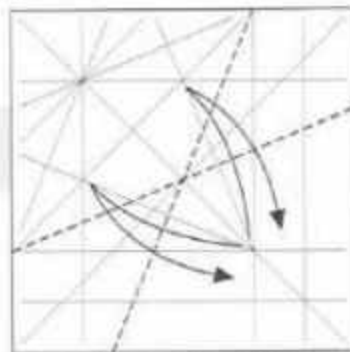

선에 맞춰 접었다 펴주세요.

10

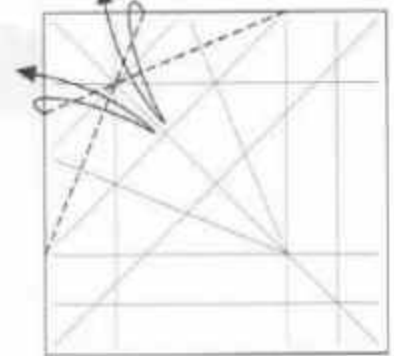

선에 맞춰 접었다 펴주세요.

8

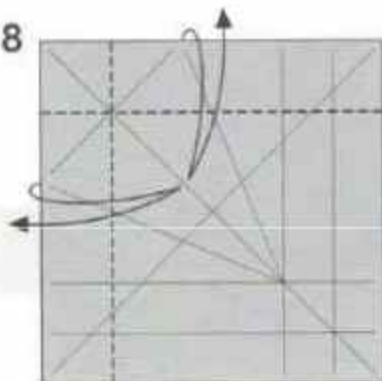

뒤집어서 수직으로 접었다 펴주세요.

9

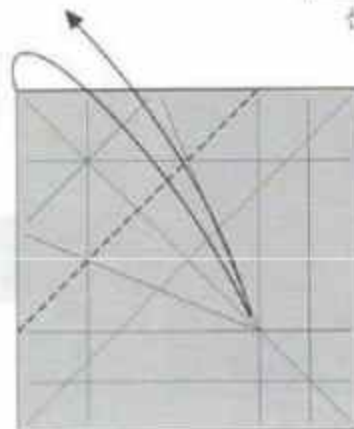

선에 맞춰 대각선으로 접었다 펴주세요.

16

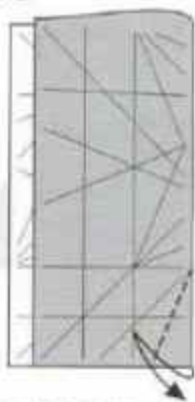

선에 맞춰 접었다 펴주세요.

17

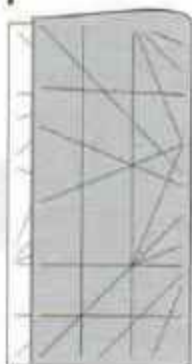

다시 펼쳐주세요.

18

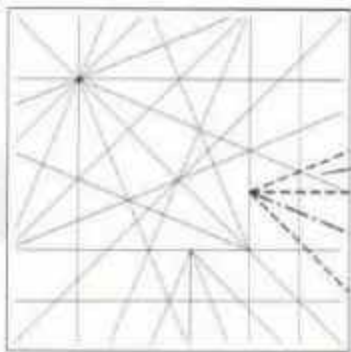

13-17

13-17을 반복해주세요.

19

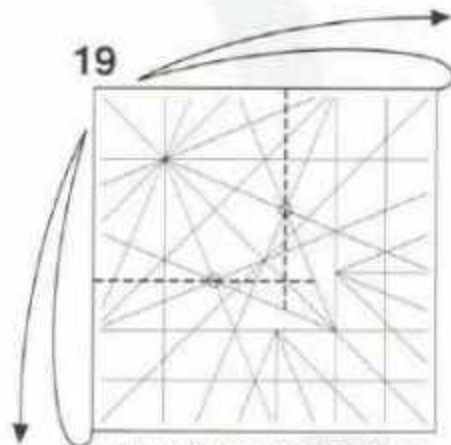

표시된 선에 맞춰 접었다 펴주세요.

21

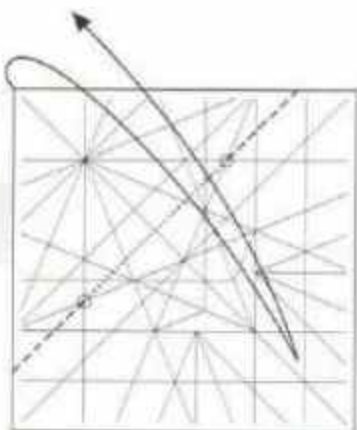

표시된 부분까지만 접었다 펴주세요.

22

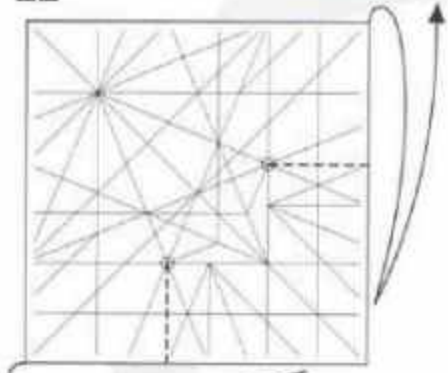

표시된 선에 맞춰 접었다 펴주세요.

20

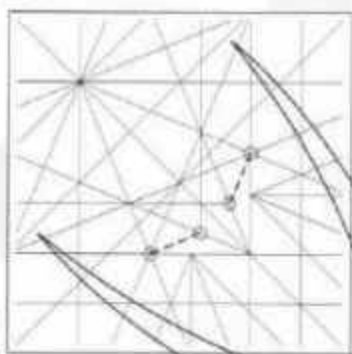

표시된 선에 맞춰 접었다 펴주세요.

23

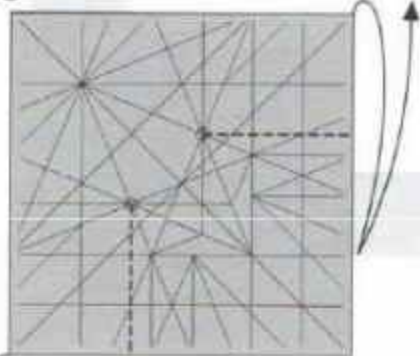

뒤집어서 표시된 선에 맞춰 접었다 펴주세요.

24

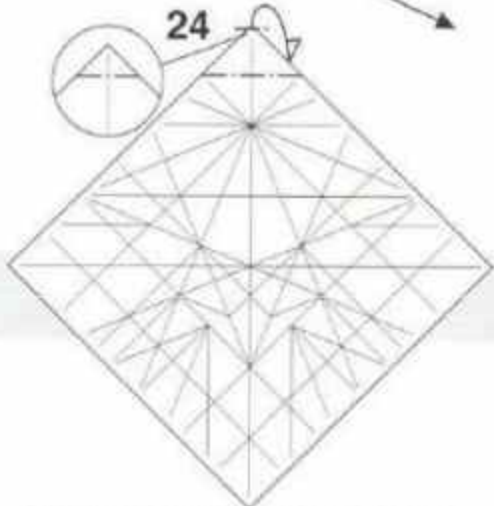

뒤집어서 표시된 부분과 끝부분을 접어주세요.

33

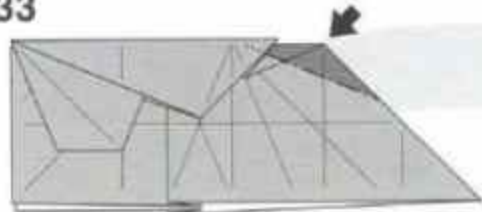

말뭉치기
(Closed sink)

34

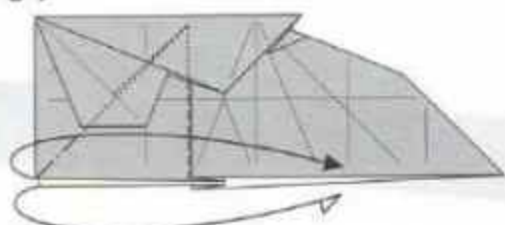

양쪽을 모두 펼쳐 놓아 접어주세요.

32



펼쳤다 펴주세요.

29

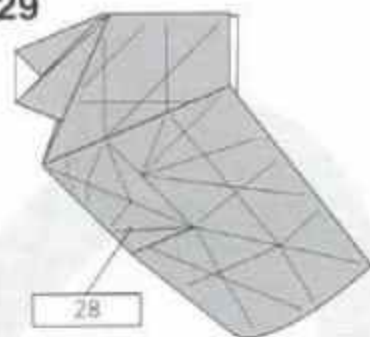

반대쪽도 28을 반복해주세요.



30

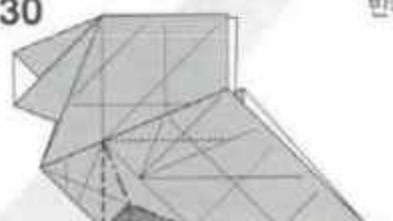

표시된 부분을 눌러 접으면서
종이를 아래로 내려주세요.

28

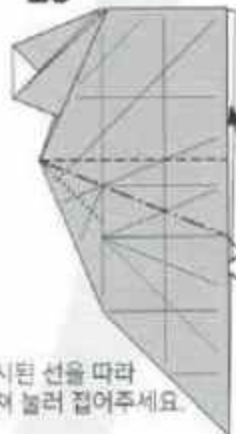

표시된 선을 따라
펼쳐 놓아 접어주세요.

31

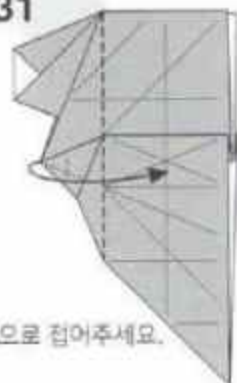

반으로 접어주세요.

27

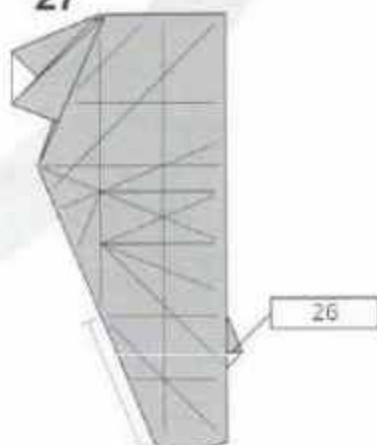

표시된 부분은 잡지 말고
반대쪽은 26을 반복해주세요.

25

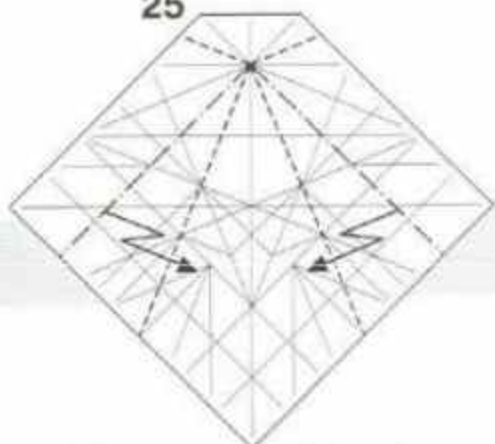

선을 따라 가운데로 모아 접어주세요.

26

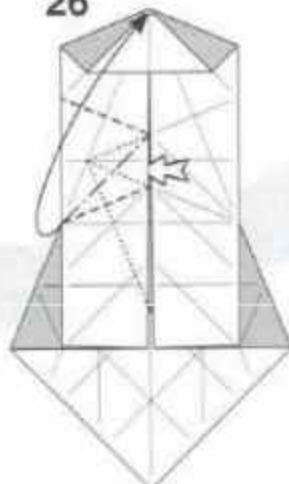

표시된 선을 따라 뒷쪽으로 접어 올리세요.

35



안쪽에 접혀있던 종이를 빼주세요.

36



선을 따라 접어 올려주세요.

37



안쪽의 종이층을 앞으로 꺼내주세요.

40

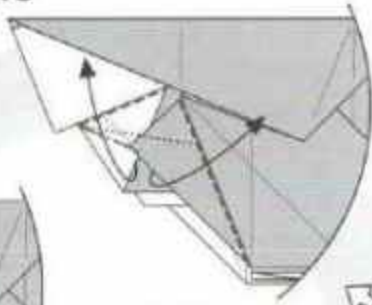

표시된 선을 따라
접어 올리세요.

38



반대쪽도 37을 반복해주세요.

41

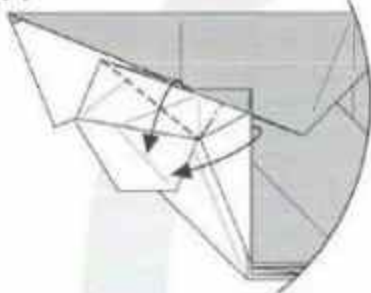

끝부분에 맞춰 접어 내리세요.

39

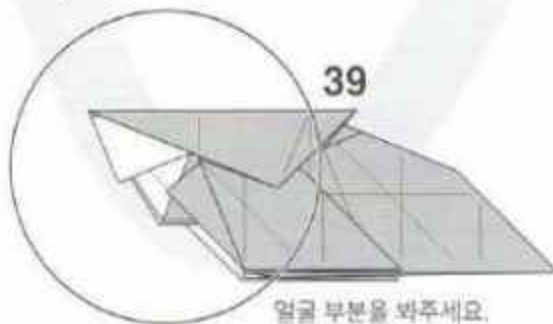

앞쪽 부분을 좌주세요.

42

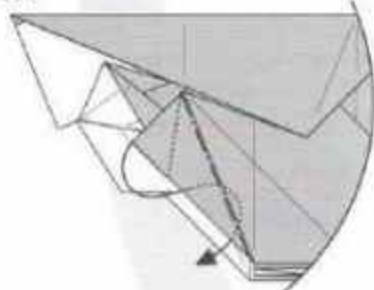

안쪽으로 펼쳐 놓러 접어주세요.

44

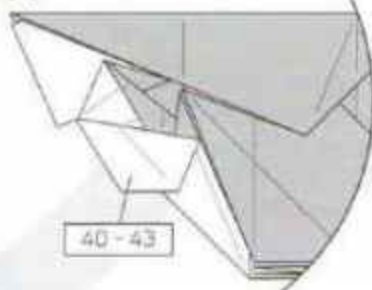

반대쪽도 40-43을 반복해주세요.

43

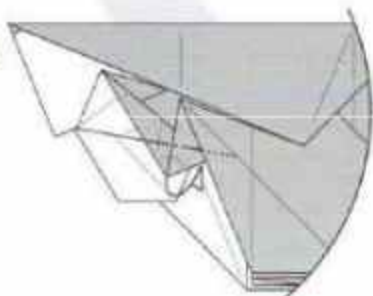

안쪽으로 접어주세요.

45

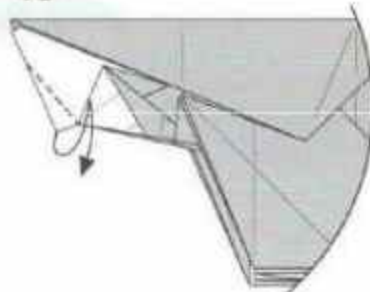

접었다 펴주세요.

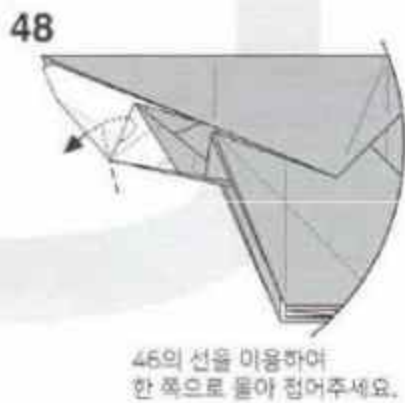
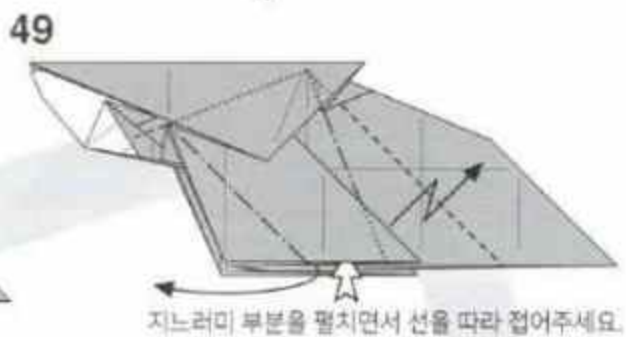
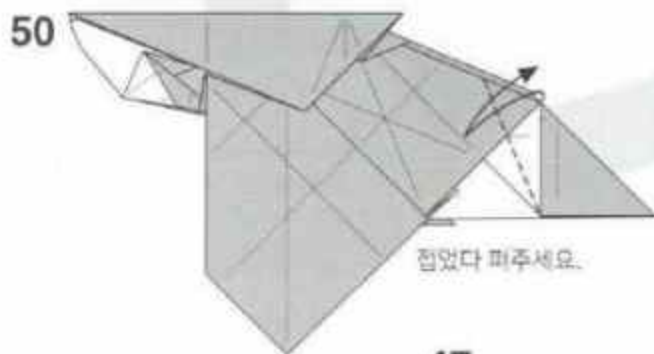
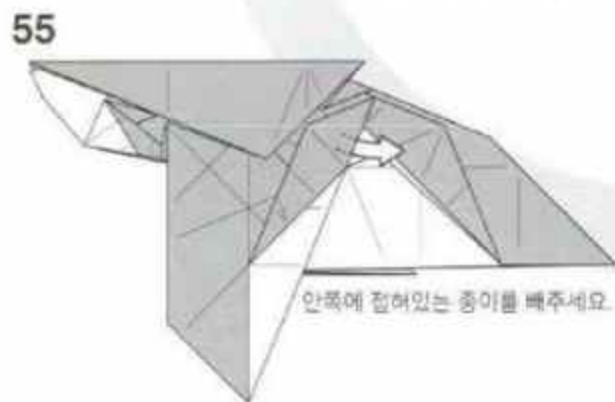
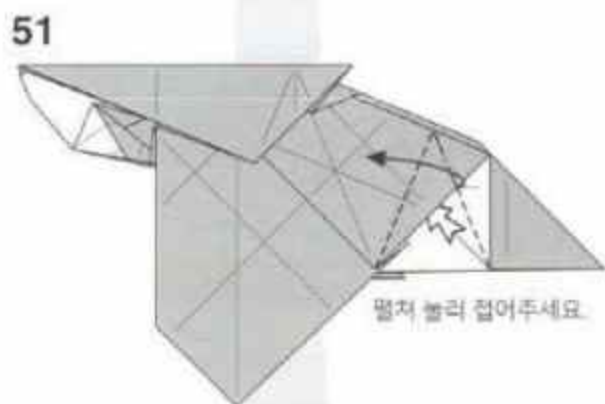
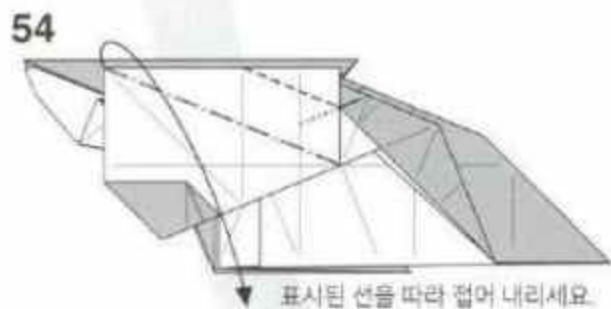
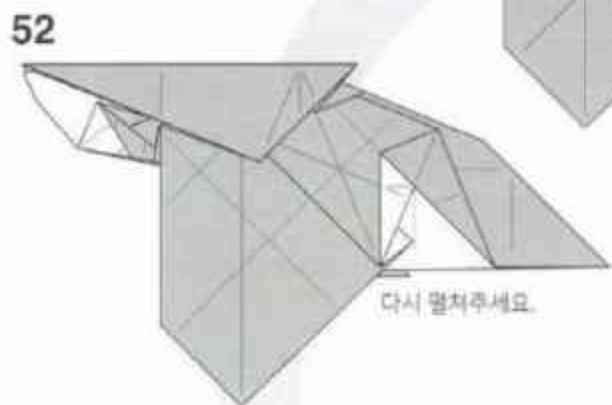
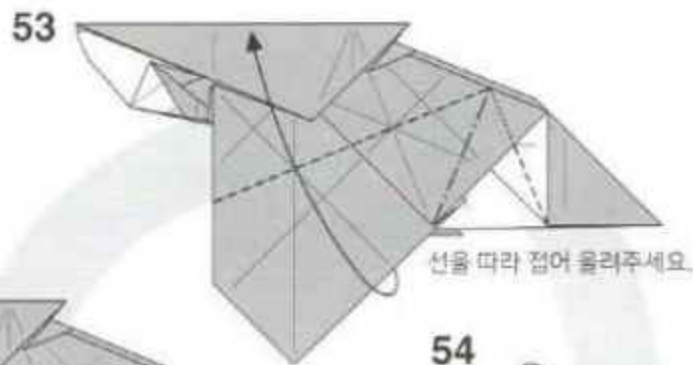

57

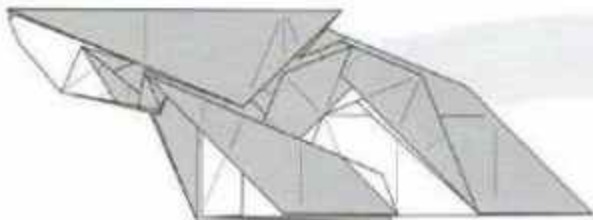

다시 펼쳐주세요.

58

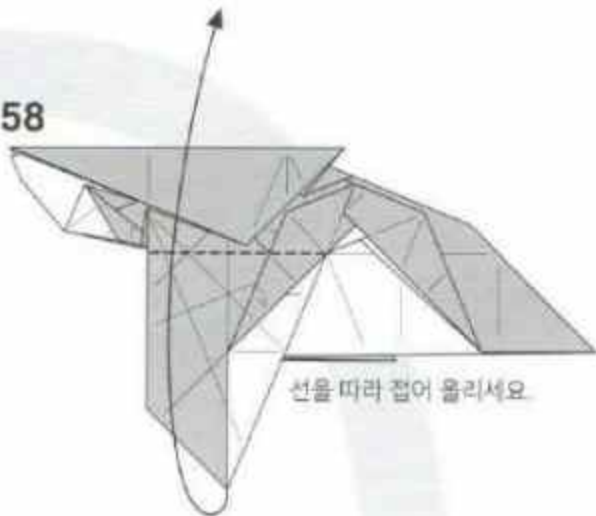

선을 따라 접어 올리세요.

56

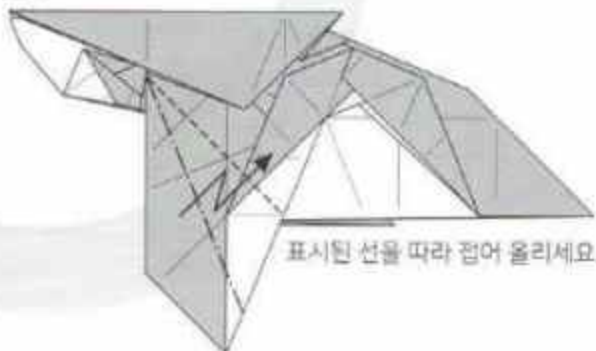

표시된 선을 따라 접어 올리세요.

59

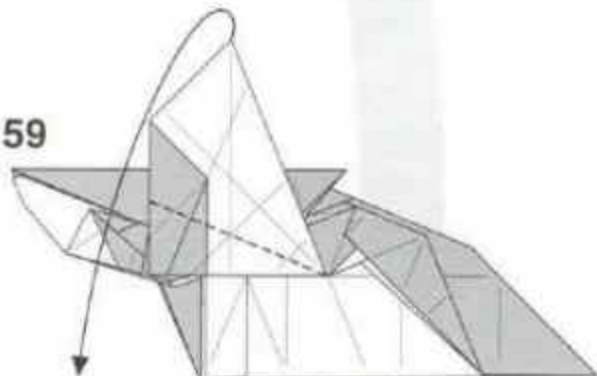

선을 따라 접어 내리세요.

61

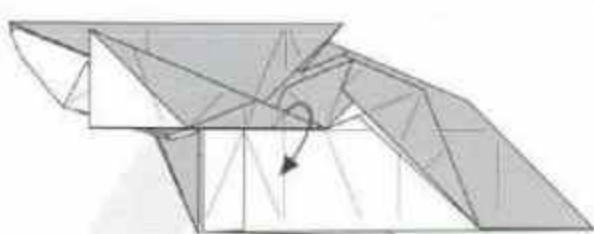

접어있는 공간을 복주세요.

60



안쪽으로 접어주세요.

62

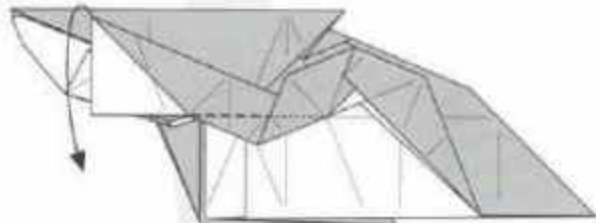

선을 따라 접어 내리세요.

65

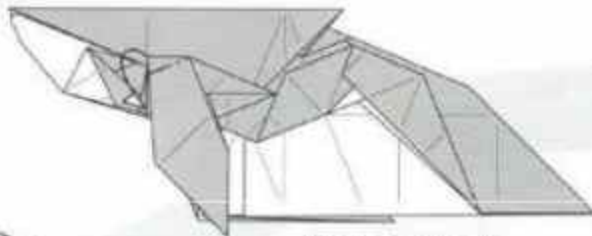

안쪽으로 접어주세요.

63

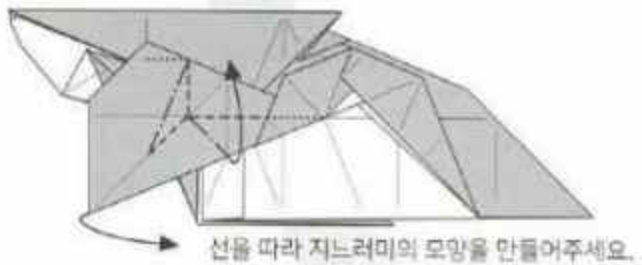

선을 따라 지느러미의 모양을 만들어주세요.

64

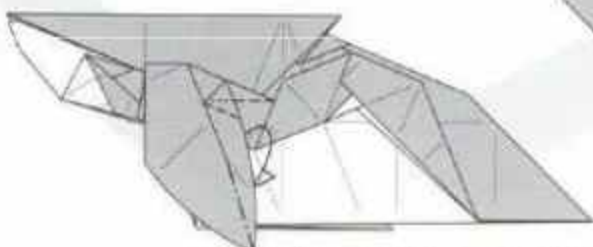

선을 따라 지느러미를 평평하게 접어주세요.

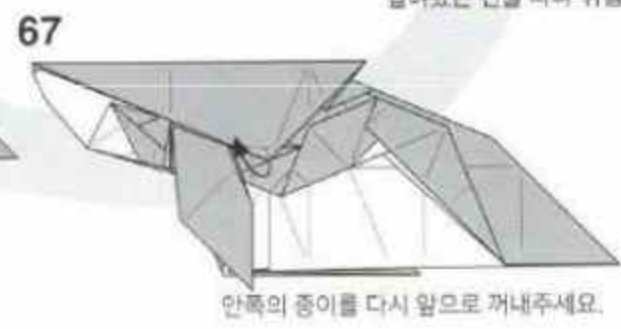
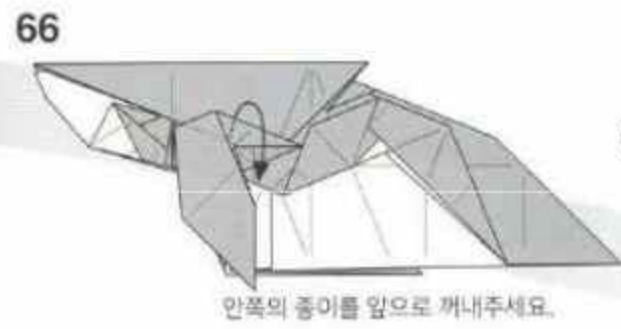
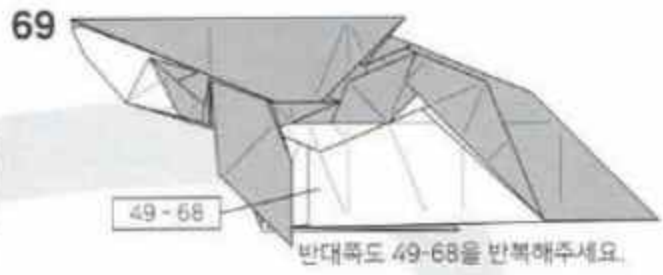
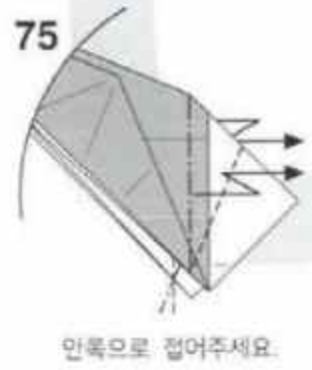
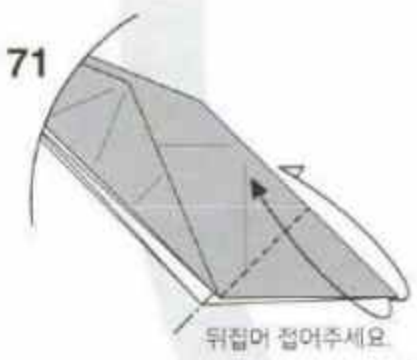
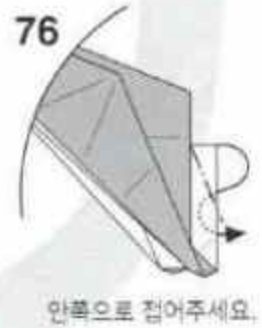
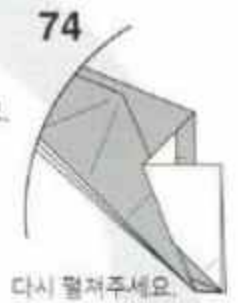
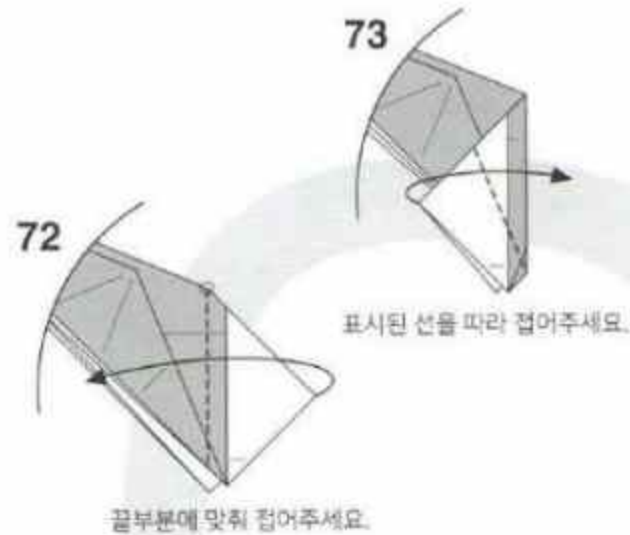

78

함몰점기
(Closed sink)

79

꼬리 끝을 접어서
둥글게 만들어주세요.

80

위 부분을 보주세요.

84

턱을 함몰점기 하면서
입체감을 만들어주세요.

81

옆쪽 끝을 접어주세요.

83

위 부분 완성

82

선을 따라 접어주세요.

85

턱 부분의 종이를
살짝 당겨주세요.

86

코 부분의 종이를
살짝 접어 올리세요.

89

완성

87

양쪽 지느러미를
안쪽을 접어주세요.

88

전체적으로 둥글게 다듬어주세요.

포크레인 ver.2

Poclain ver.2

- Creator : 김진우(Kim Jin Woo)
- Diagram : 박종우(Park Jong Woo)
- Size : 45cm x 45cm

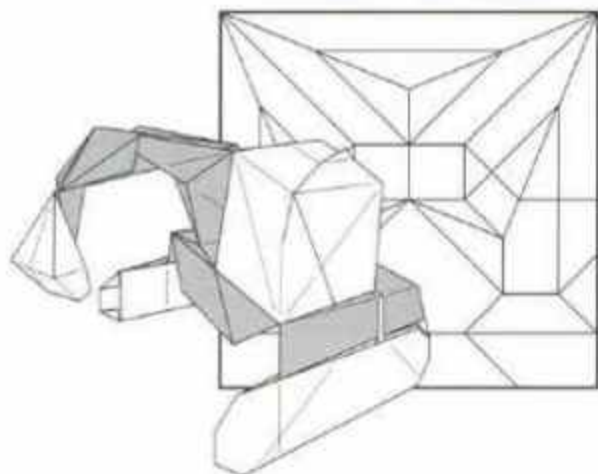

12

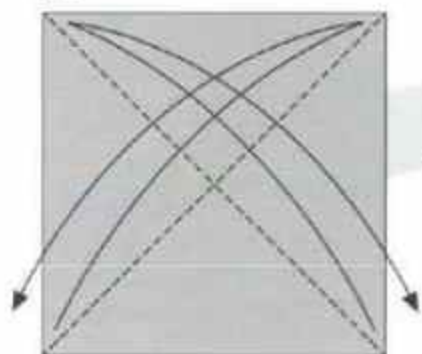

대각선으로 접었다 펴주세요.

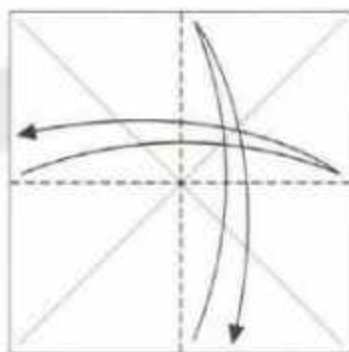

뒤집어서 수직으로 접었다 펴주세요.

3

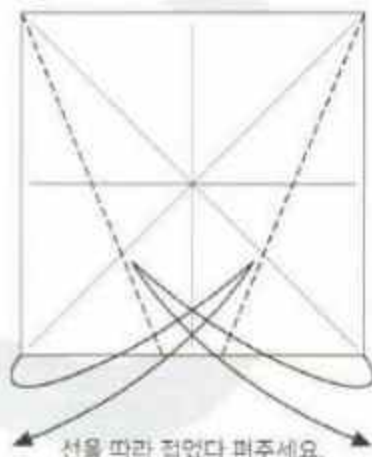

선을 따라 접었다 펴주세요.

5

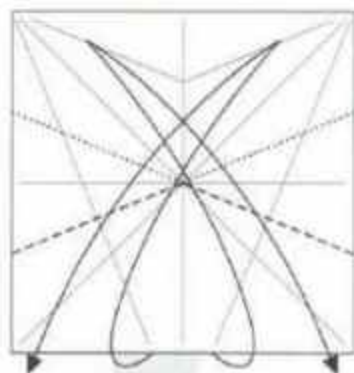

표시된 부분까지만 접었다 펴주세요.

4

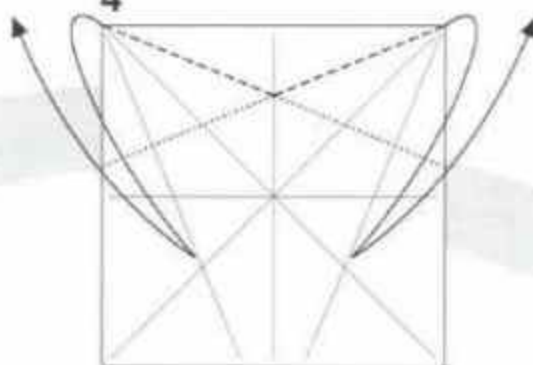

표시된 부분까지만 접었다 펴주세요.

7

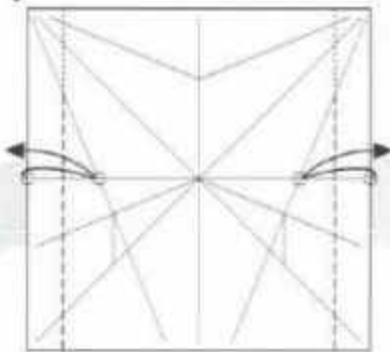

표시된 부분까지만 접었다 펴주세요.

6

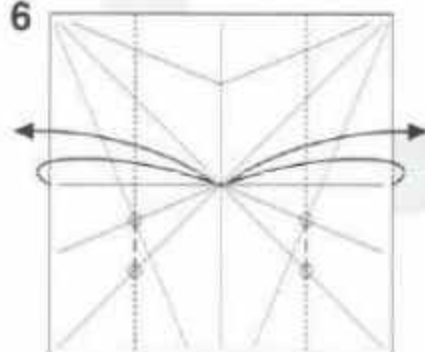

표시된 부분까지만 접었다 펴주세요.

8

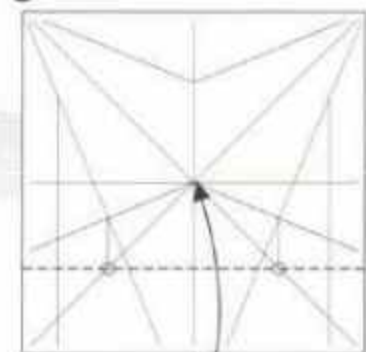

표시된 부분에 맞춰 접어 올리세요.

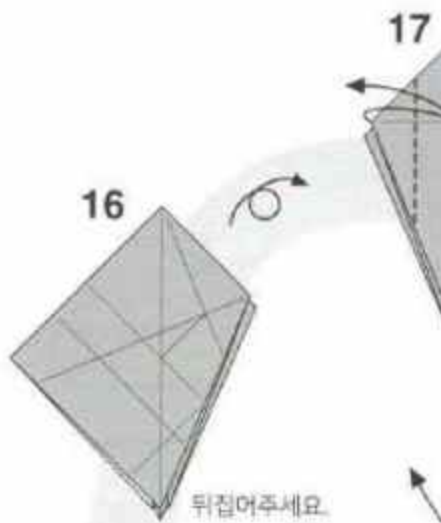

16

뒤집어주세요.

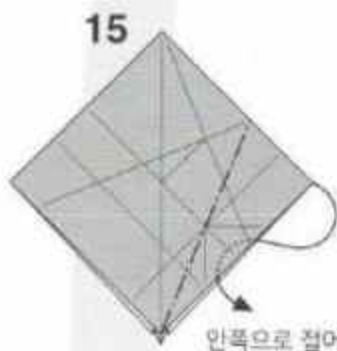

15

안쪽으로 접어주세요.

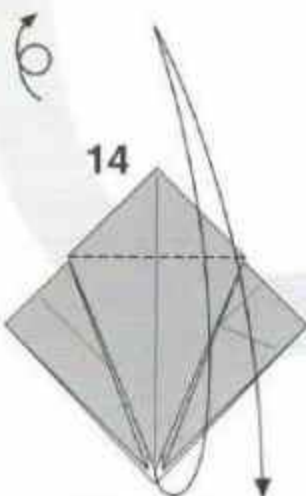

14

접었다 펴주세요.

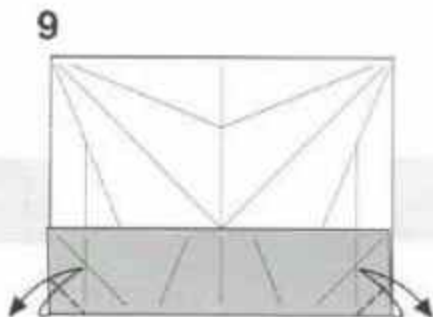

9

선에 맞춰 접었다 펴주세요.



17

선에 맞춰 접었다 펴주세요.

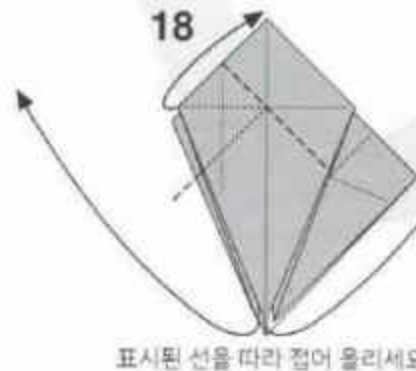

18

표시된 선을 따라 접어 올리세요.

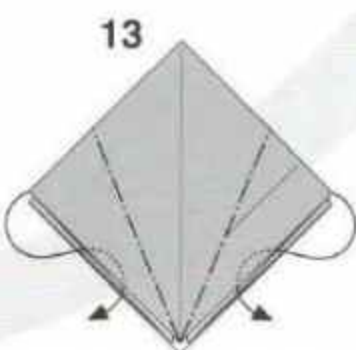

13

안쪽으로 펼쳐 눌러 접어주세요.
(Inside reverse fold)

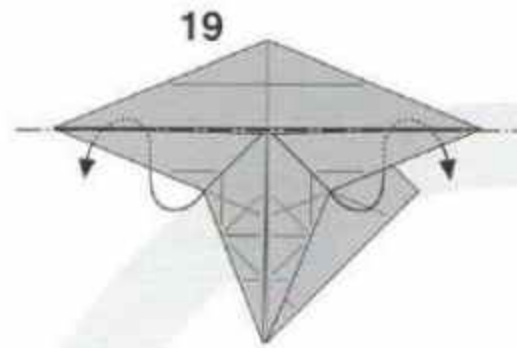

19

안쪽으로 접어주세요.

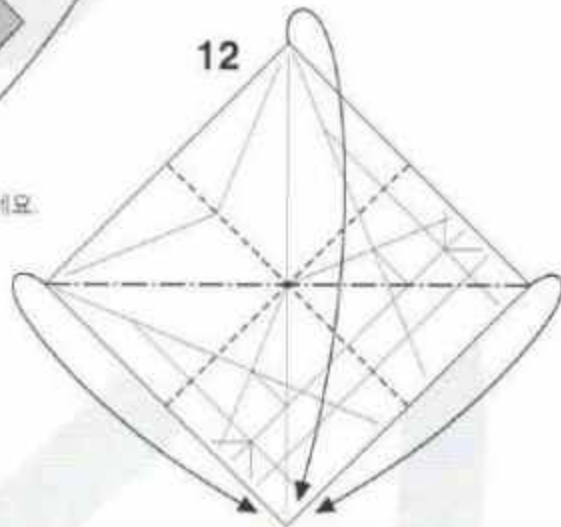

12

예비선의 위치들을 잘 확인하며
사각 주머니 접기를 해주세요.

11

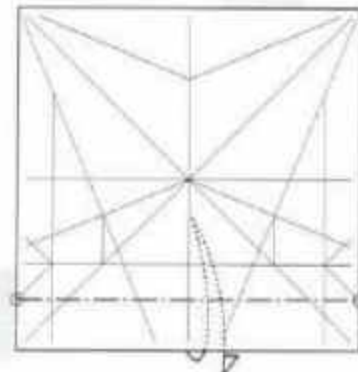

9의 선에 맞춰 접었다 펴주세요.

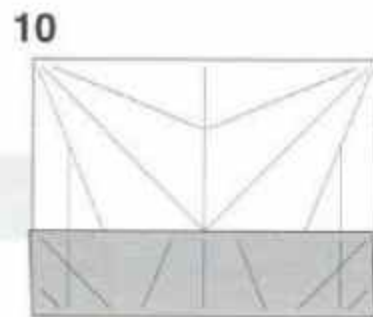

10

다시 펼쳐주세요.

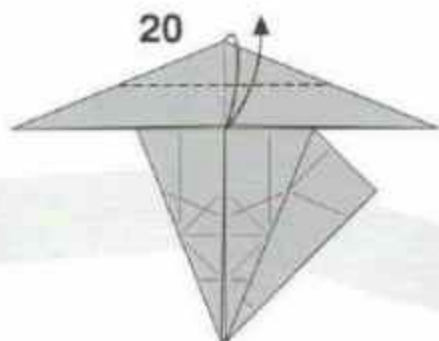

선에 맞춰 접었다 펴주세요.

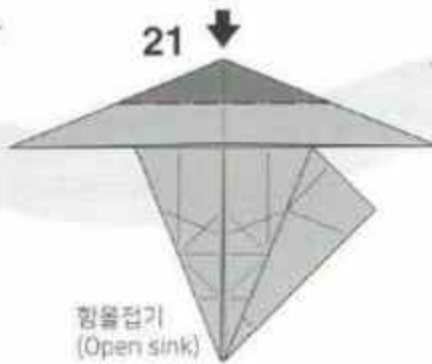

함몰접기
(Open sink)

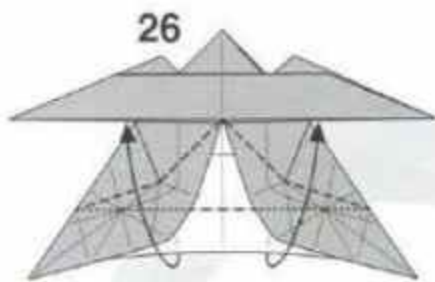
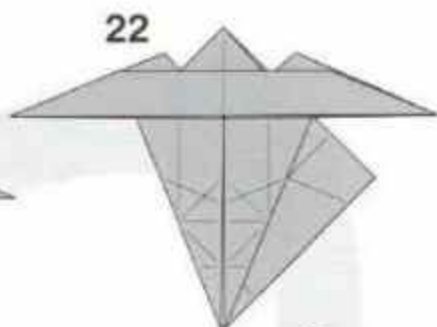

선을 따라 접어 올려 평평하게 만들어주세요.

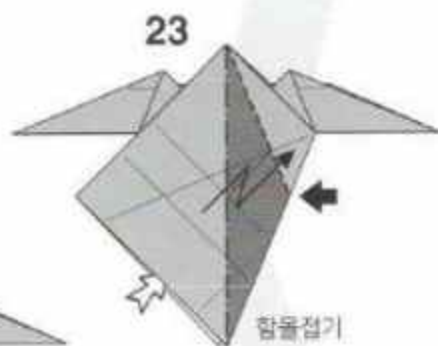
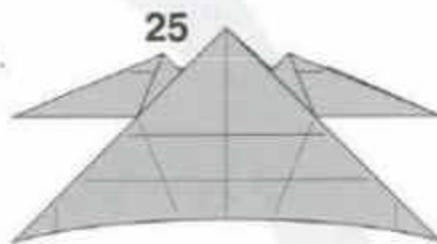

함몰접기

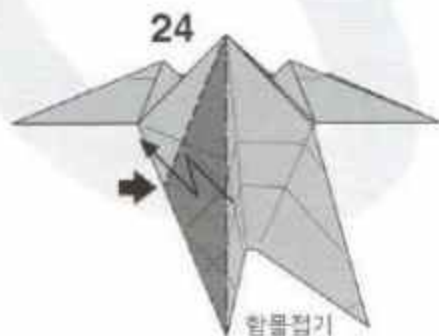

함몰접기

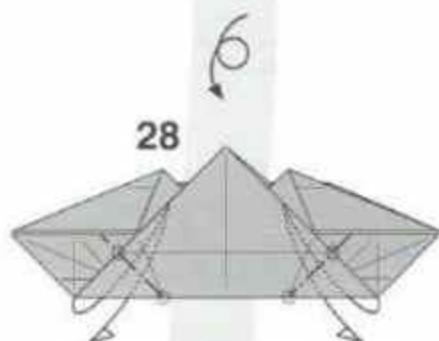

표시된 부분에 맞춰 접었다 펴주세요.

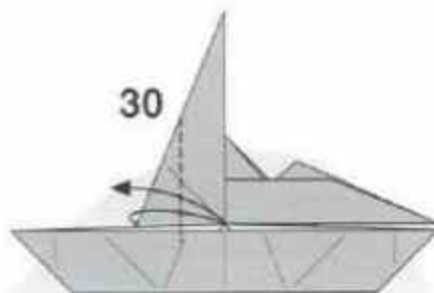

선에 맞춰 접었다 펴주세요.

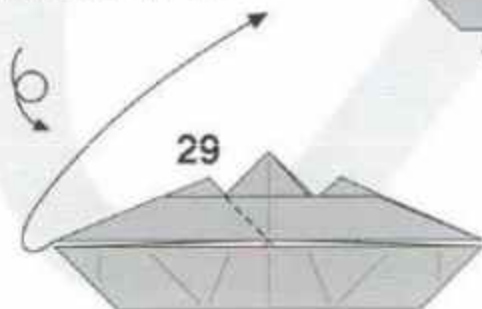

한 쪽을 접어 올리세요.

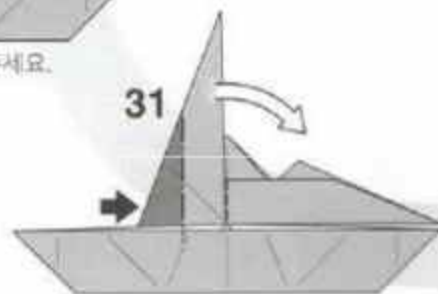

종이를 당기면서 함몰접기 해주세요.
(Spread sink)

43

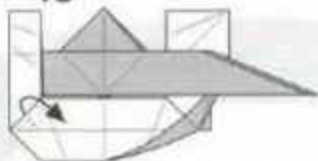

안쪽에 접혀있는 종이를 빼주세요.

44



선을 따라 접어 올리세요.

42



선을 따라 뒤집어주세요.

45

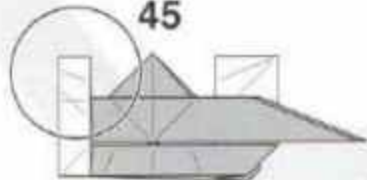

바깥 앞부분을 봐주세요.

41



반대쪽으로 접어주세요.

37

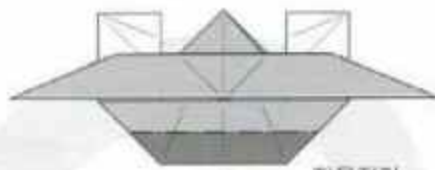

힘들접기
(Open sink)

40



38



36

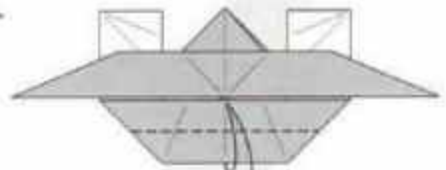

반으로 접었다 피주세요.

39



반으로 접었다 피주세요.

35

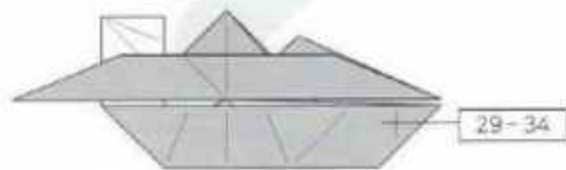

29-34

반대쪽도 29-34를 반복해주세요.

32



선을 따라 접어주세요.

33

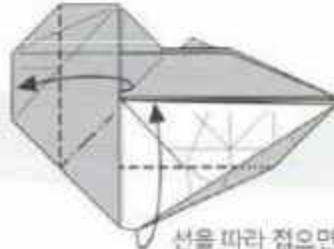

선을 따라 접으면서
색판전을 만들어주세요.

34

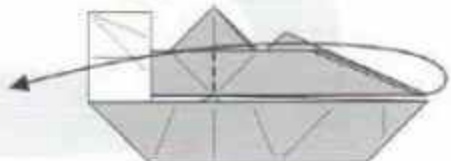

종이층을 반대쪽으로 접어주세요.

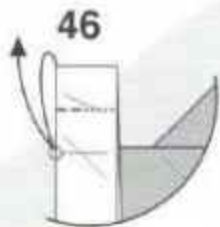

선에 맞춰 끝부분만 접었다 펴주세요.

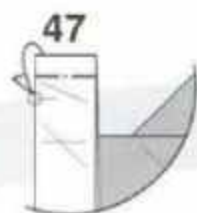

표시된 선에 맞춰 뒤로 접어주세요.

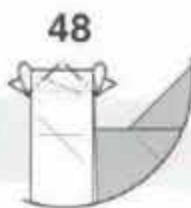

표시된 선에 맞춰 뒤로 접어주세요.

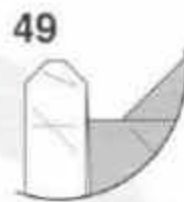

바위 앞부분 완성

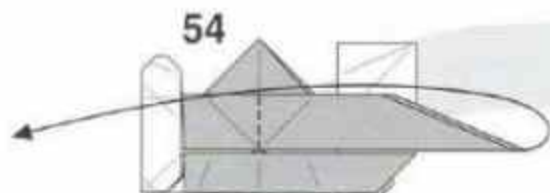

종이중을 반대쪽으로 접어주세요.

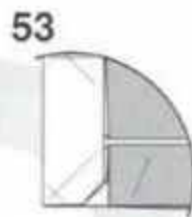

다시 전체를 봐주세요.



바위 뒷부분을 봐주세요.

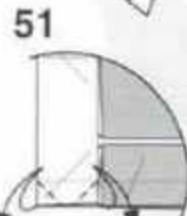

표시된 선에 맞춰 접었다 펴주세요.

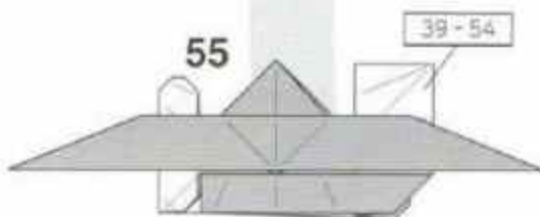

반대쪽도 39-54를 반복해주세요.

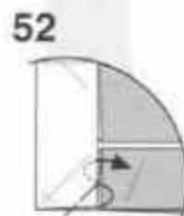

안쪽으로 펼쳐 눌러 접어주세요.
(Inside reverse fold)

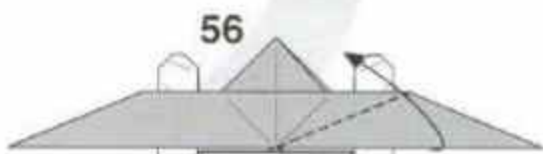

선에 맞춰 접어 올리세요.

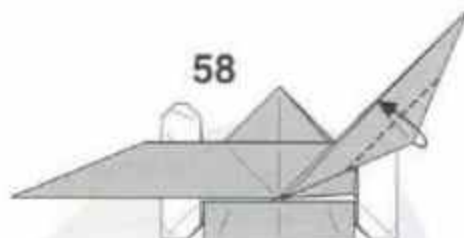

중심에 맞춰 반으로 접어주세요.

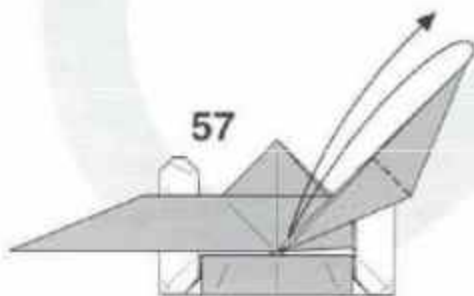

반으로 접었다 펴주세요.



선에 맞춰 접었다 펴주세요.

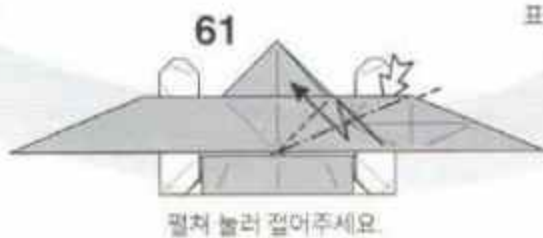
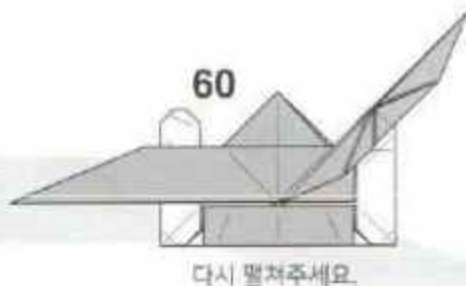
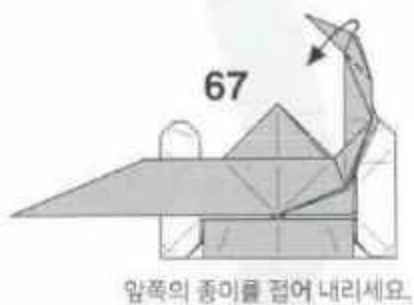
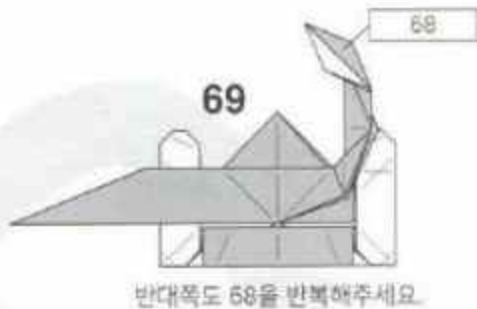
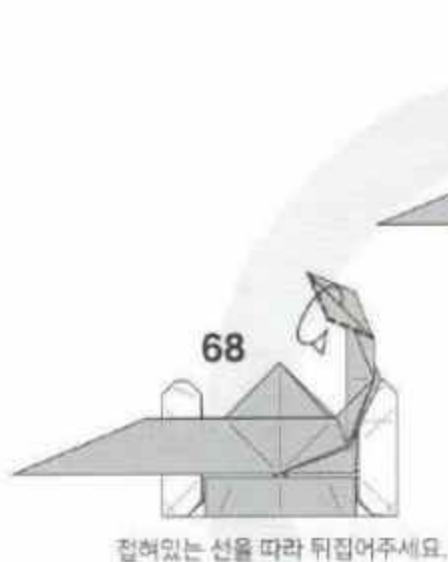

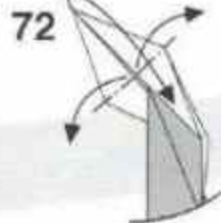

펼쳐 눌러 접어주세요.



선에 맞춰 접었다 펴주세요.



표시된 선을 따라 계단접기 해주세요.

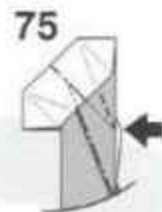

선을 따라 안쪽으로 펼쳐 눌러 접어주세요.



안쪽으로 펼쳐 눌러 접어주세요.

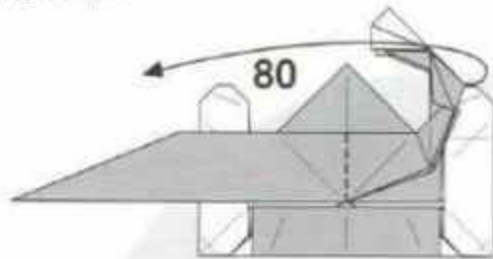

서랍을 반대쪽으로 접어주세요.

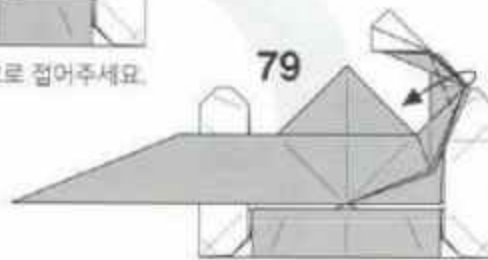

반대쪽도 반복해주세요.



접혀있는 선을 따라 뒤집어주세요.

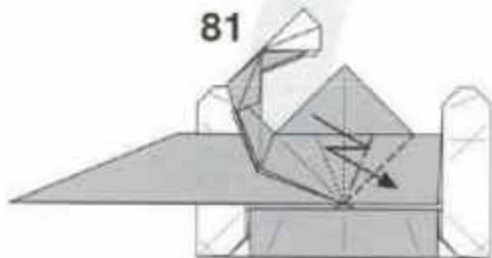

표시된 선을 따라 계단접기 해주세요.



반대쪽도 76-77을 반복해주세요.

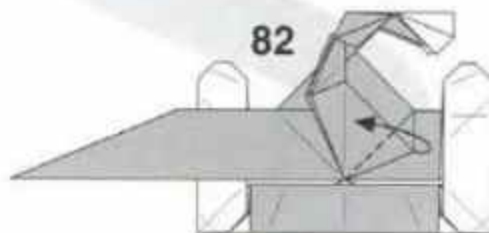

선을 따라 접어주세요.

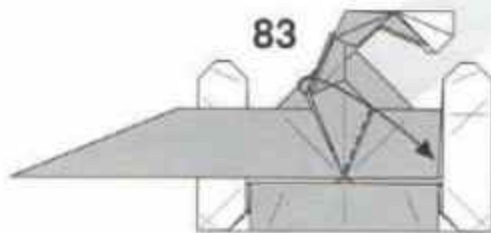

선을 따라 접어주세요.

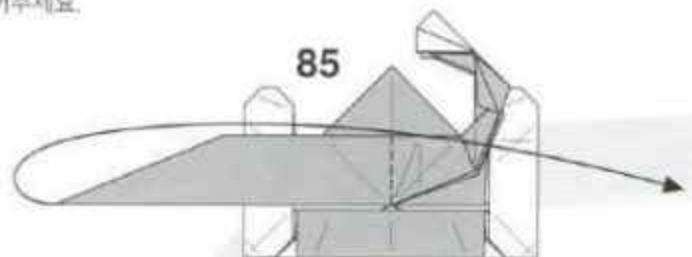

종이를 반대쪽으로 접어주세요.

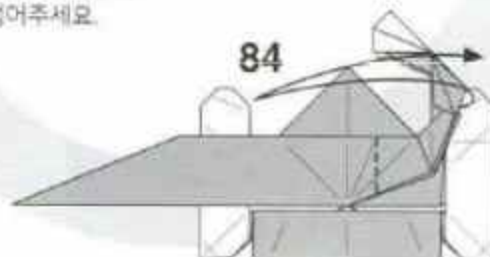

선을 따라 접었다 펴주세요.

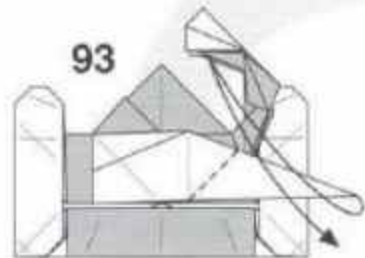

표시된 선을 따라 접었다 펴주세요.

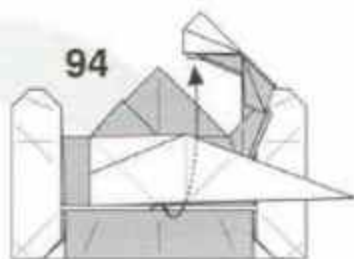

뒷쪽의 종이층을 들어 올리세요.

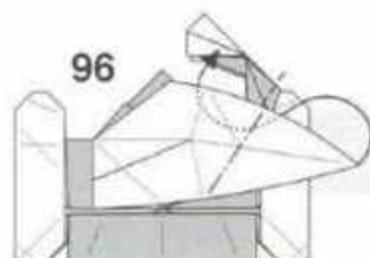

안쪽으로 펼쳐 눌러 접어주세요.

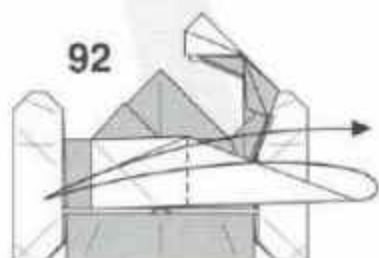

표시된 선을 따라 접었다 펴주세요.

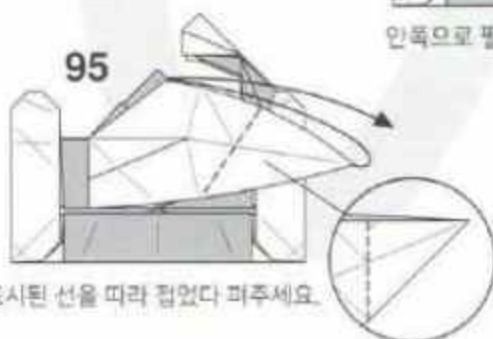

표시된 선을 따라 접었다 펴주세요.



표시된 선을 따라 접어 올리세요.

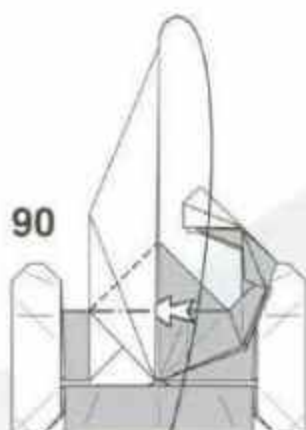

표시된 선을 따라 한 겹을 접으면서 내려주세요.

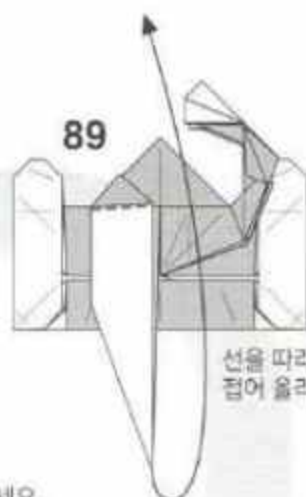

선을 따라 한 겹을 접으세요.

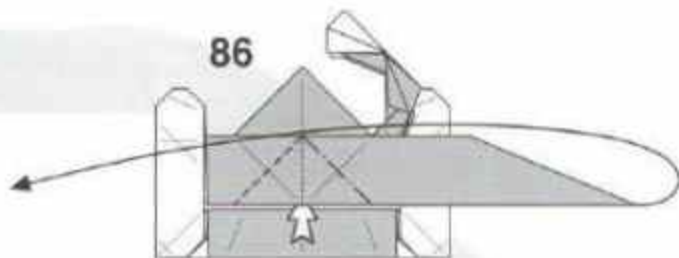

종이 한 겹을 들어 올리면서 반대쪽으로 접어주세요.

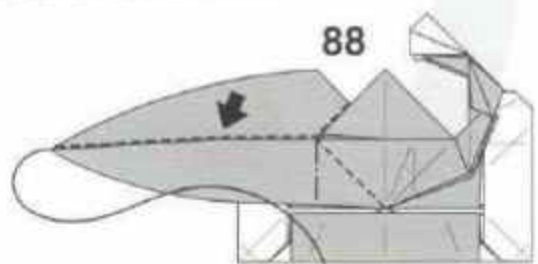

튀어나온 부분을 함몰시키면서 뒤집어주세요.

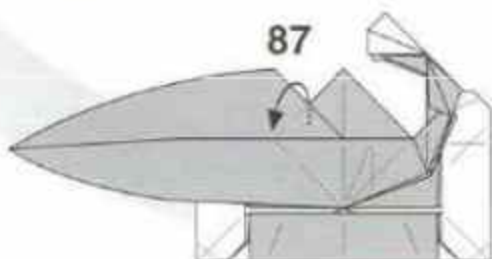

뒷쪽의 종이를 앞으로 꺼내주세요.

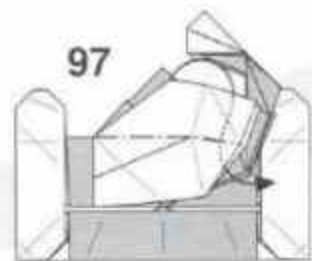

선을 따라 다시 평평하게 접어주세요.

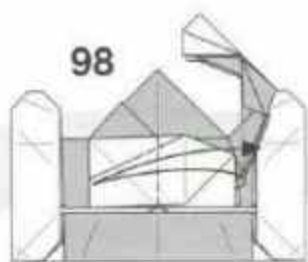

표시된 선을 따라 접었다 펴주세요.

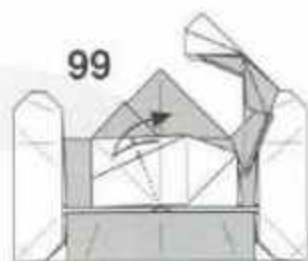

표시된 선을 따라 끝부분만 접었다 펴주세요.



조종석의 앞부분을
각지게 만들어주세요.

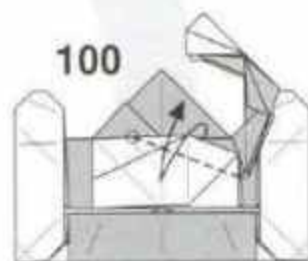

표시된 부분에 맞춰 접었다 펴주세요.

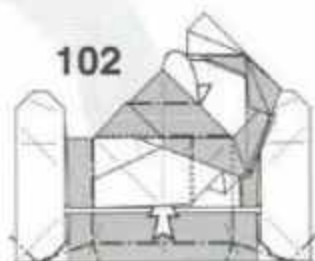

전체를 입체로 만들어주세요.

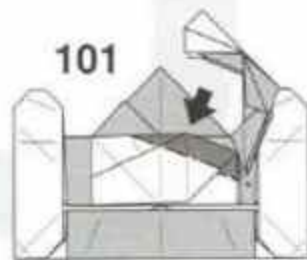

함몰접기
(Closed sink)

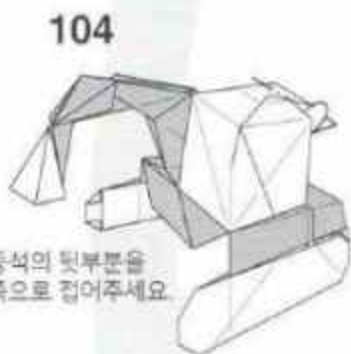

조종석의 뒷부분을
안쪽으로 접어주세요.



조종석의 뒷부분을
반쪽하게 세워주세요.

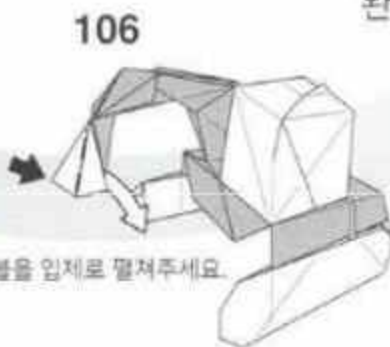

서랍을 입체로 펼쳐주세요.

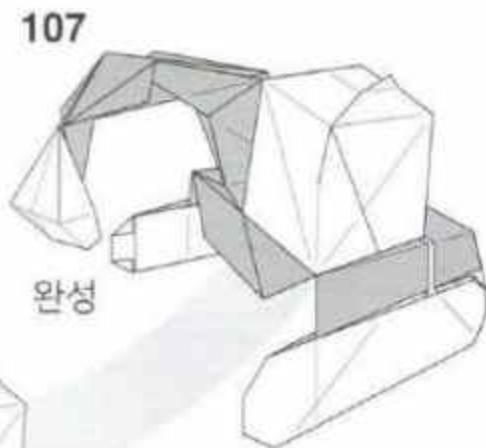

완성

맹꽁이

Boreal digging frog

- Creator : 한지우(Han Ji Woo)
- Diagram : 이인섭(Lee In Seop)
- Size : 40cm x 40cm

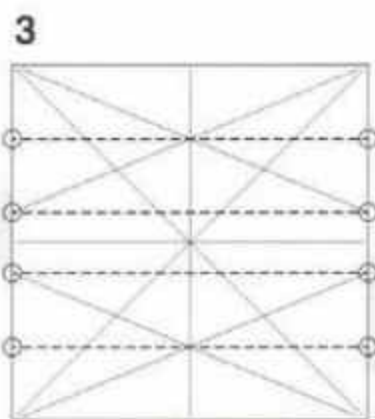
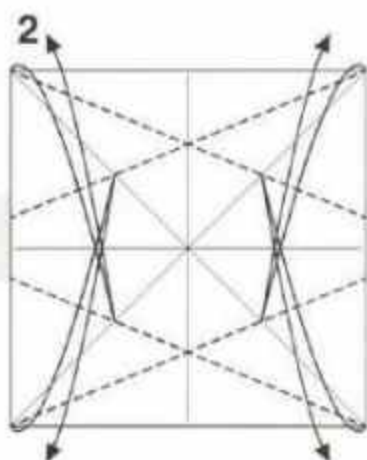
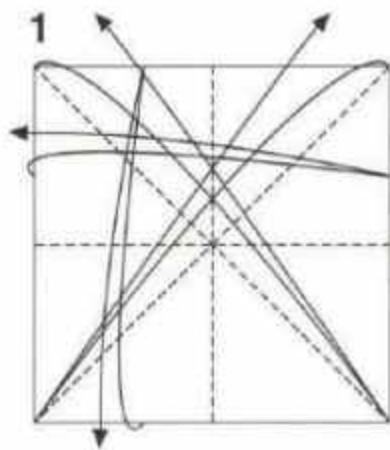
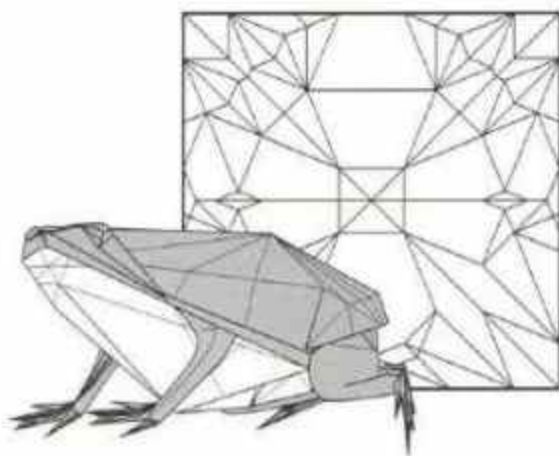

점에 맞춰 접습니다.

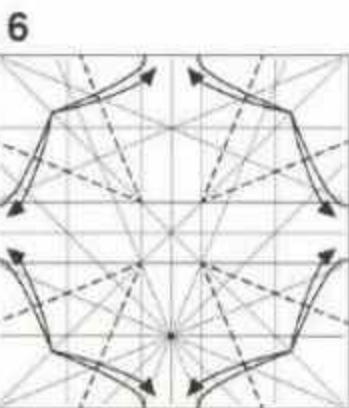

각을 이동분합니다.

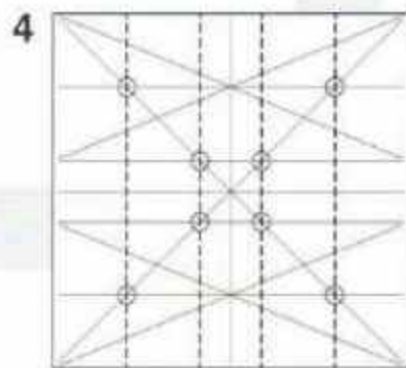
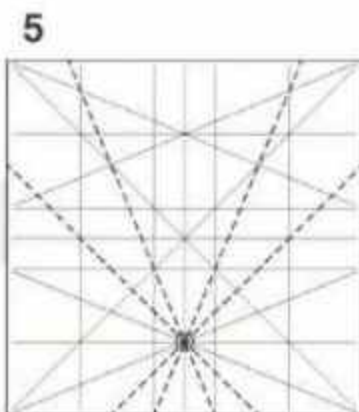

점에 맞춰 접습니다.

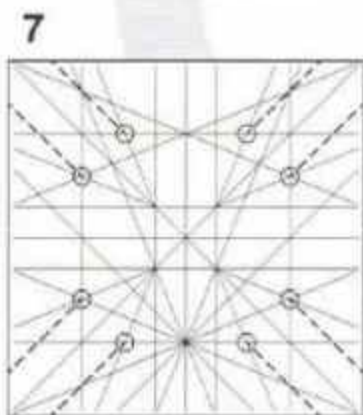

점에 맞춰 접습니다.

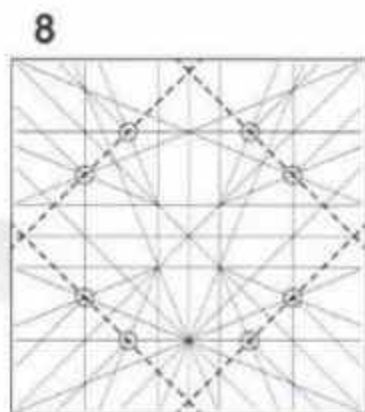

점에 맞춰 접습니다.

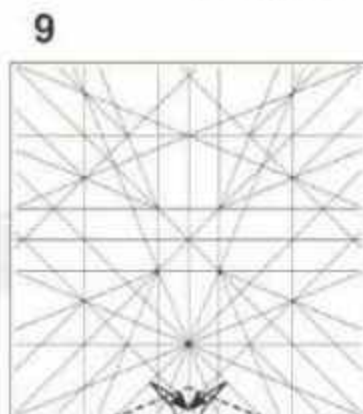

각을 이동분하고 뒤집습니다.

17

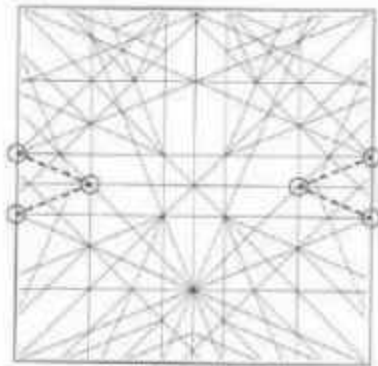

점에 맞춰 접습니다.

18

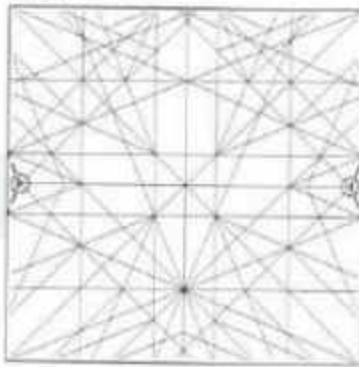

점에 맞춰 접습니다.

21

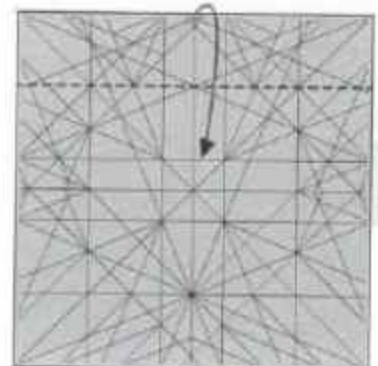

아래로 내려접습니다.



16

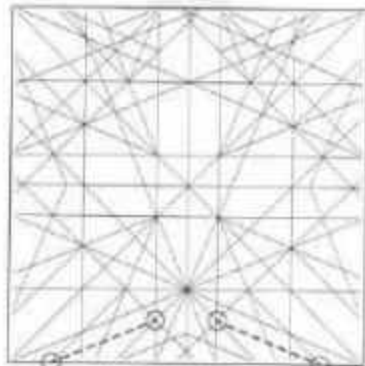

점에 맞춰 접습니다.

19

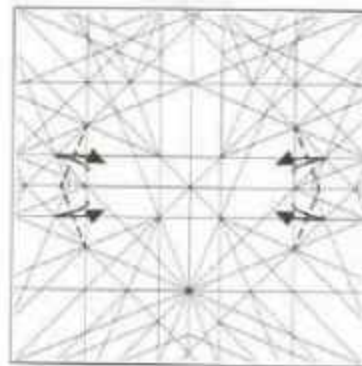

20

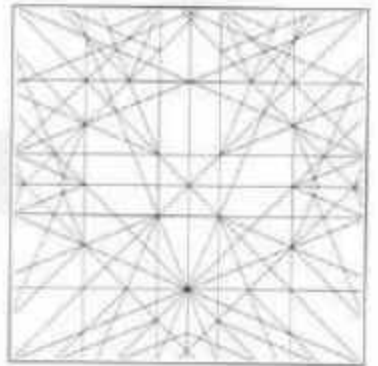

15

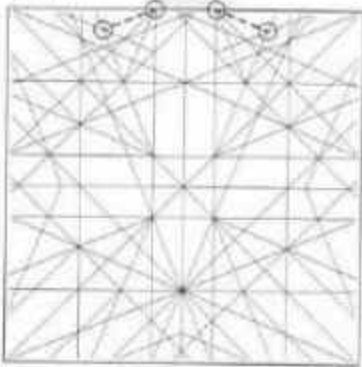

점에 맞춰 접습니다.

14

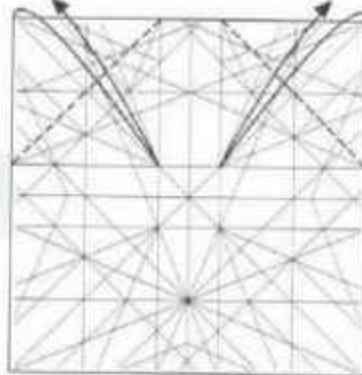

13

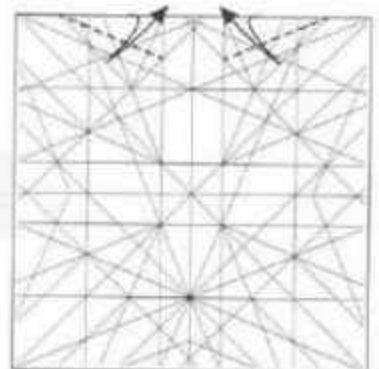

각을 이동분합니다.



10

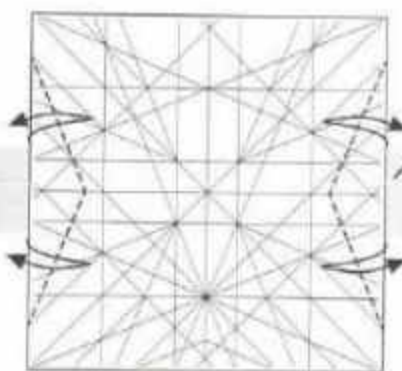

각을 이동분하고 뒤집습니다.

11

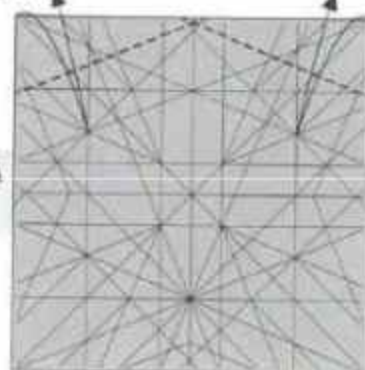

각을 이동분 합니다.

12

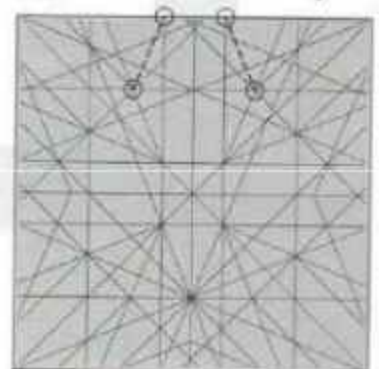

점에 맞춰 접고 뒤집습니다.

22

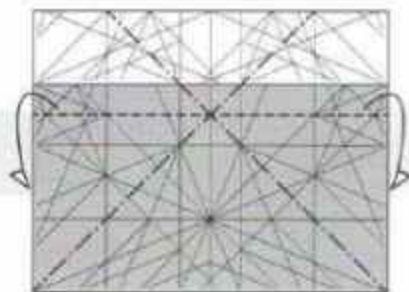

23

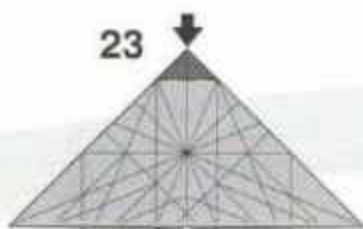

함몰접기
(open sink)

24

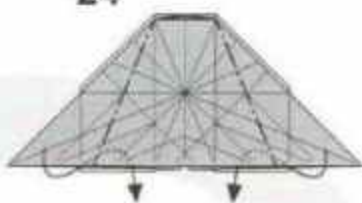

25



뒤로 넘기며 접습니다.

29

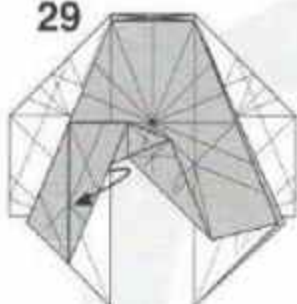

25처럼 펼칩니다.

28

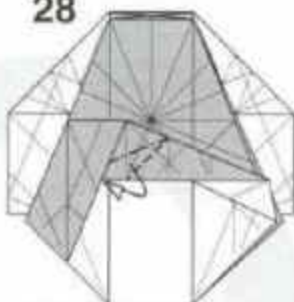

뒤로 넘기며 접습니다.

27



뒤로 넘기며 접습니다.

26

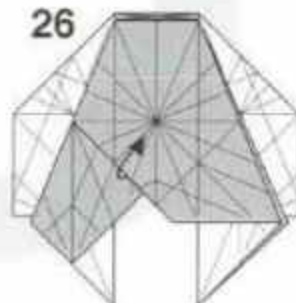

접지 않고 위로 들어올립니다.

30

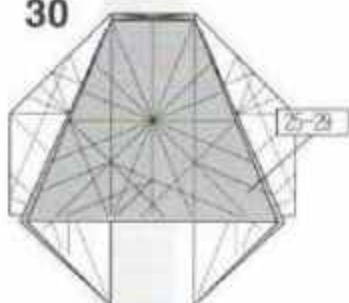

반대쪽도 25-29를 반복합니다.

33

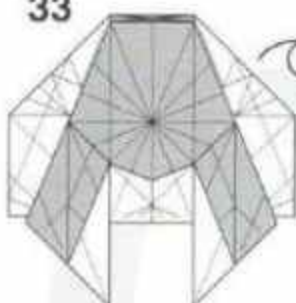

34

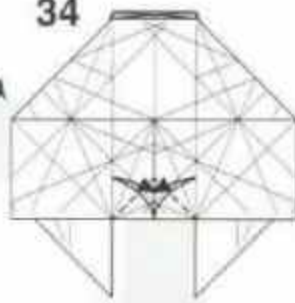

잡았다 편 선을 넘는다.

31

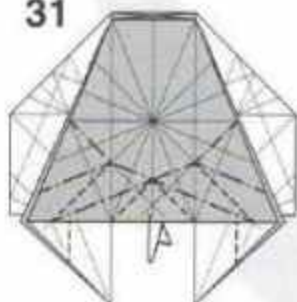

양쪽 모두 선대로 뒤로 접습니다.

32

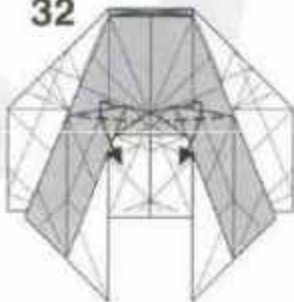

평면으로 내려접습니다.

35

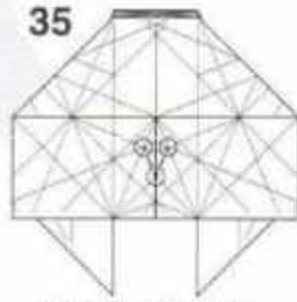

잡았다 편 선을 넘는다.

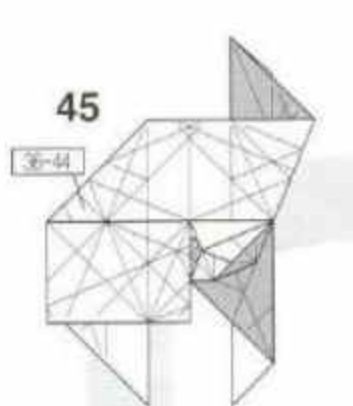

반대쪽도 36-44를 반복합니다.

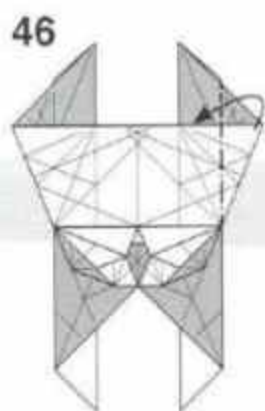

안으로 접어넣습니다.

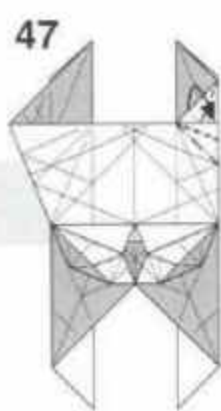

22.5각도로 접습니다.

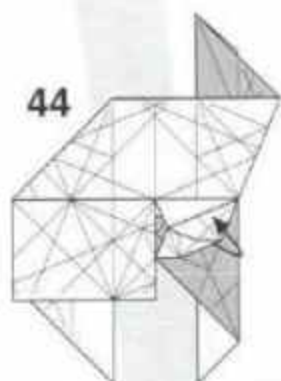
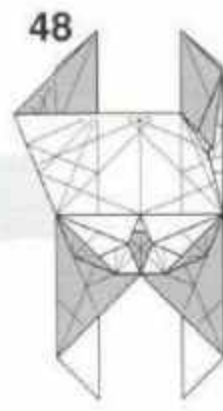

안으로 각을 뒤집어 씌웁니다.

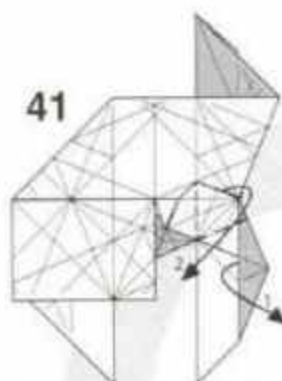

1에서 펼치고 2로 내려접습니다.

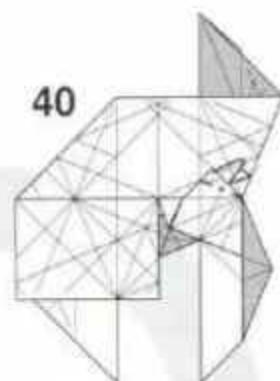

안으로 접어 넣습니다.

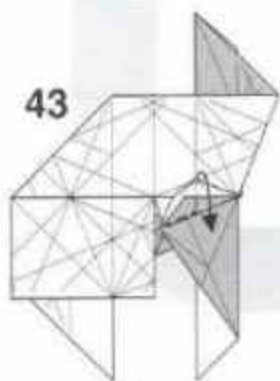

내려접습니다.

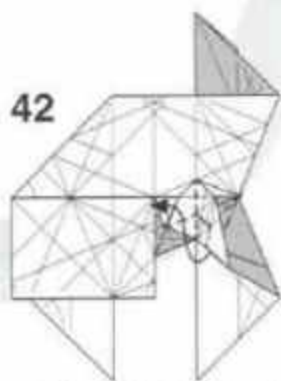

화살표 방향으로 접습니다.

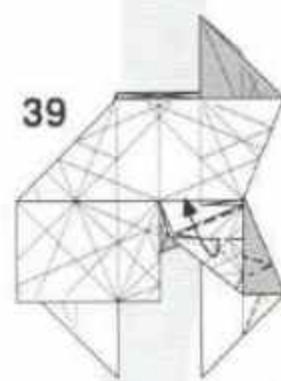

안쪽 부분을 위로 넘겨 평면으로 만듭니다.

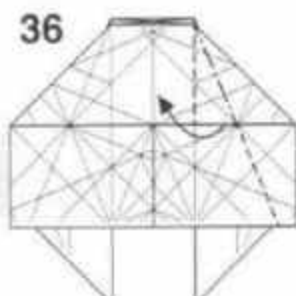

앞쪽으로 접습니다.

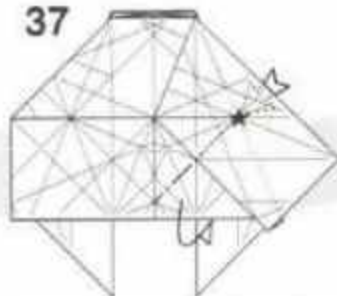

술머리는 ★를 눌러 안으로 합니다.

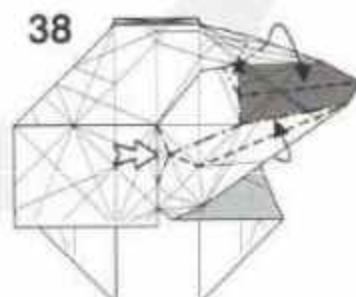

35에서 된 선을 누르며 접습니다.

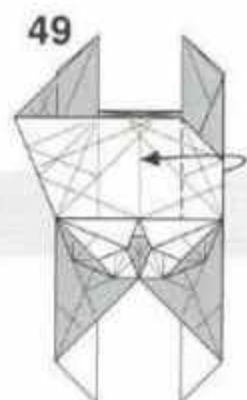

반대쪽으로 넘깁니다.

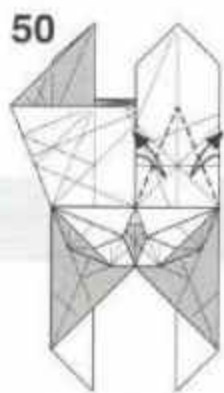

접었다 편 선을 넘니다.

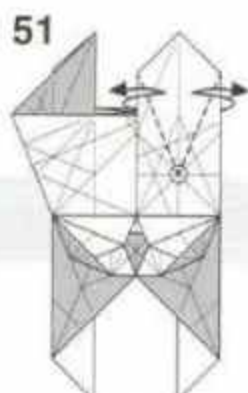

접었다 편 선을 넘니다.

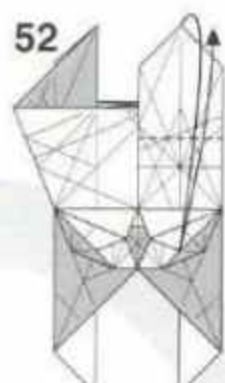

접었다 편 선을 넘니다.

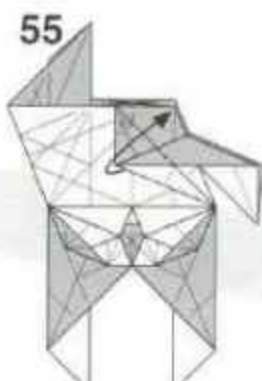
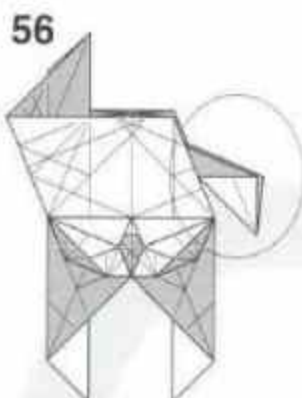

다시 접어 올립니다.

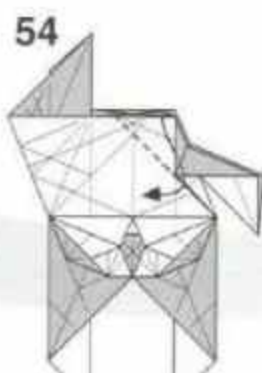

펼치며 접습니다.

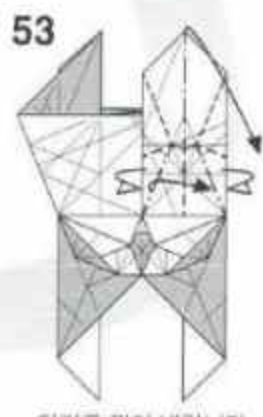

다리를 꺾어 내립니다.

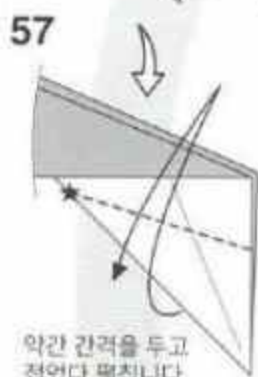

약간 간격을 두고
접었다 펼칩니다.

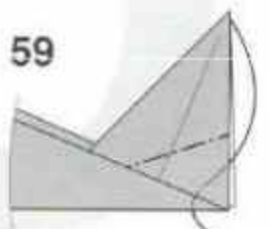
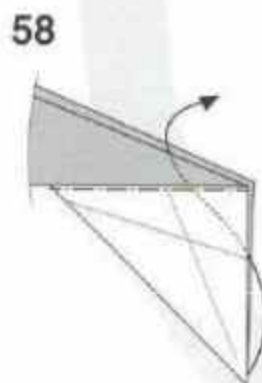
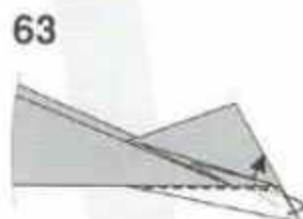
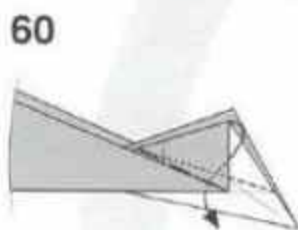
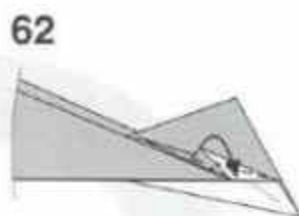
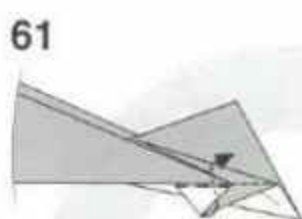

57에서 낸 선대로 접습니다.



안쪽으로 종이를 집어넣습니다.

75

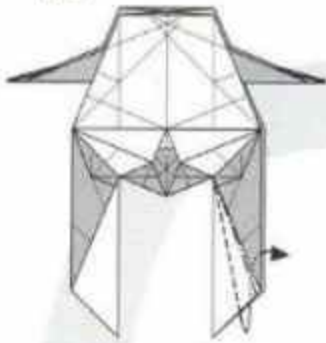

두번 꺾어 접습니다.

76

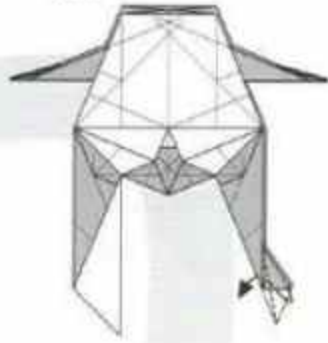

79

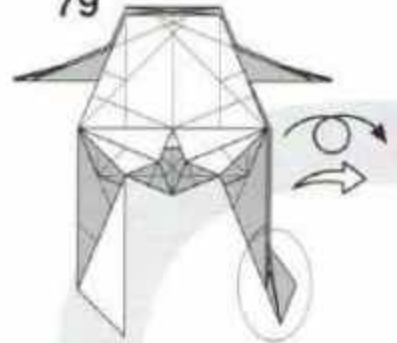

뒤집습니다.

74

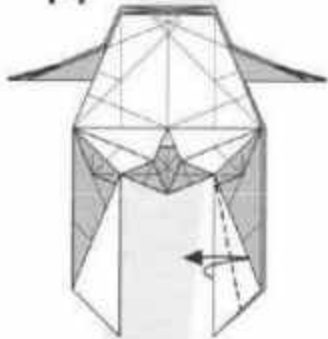

접었다면 편 선을 냅니다.

77

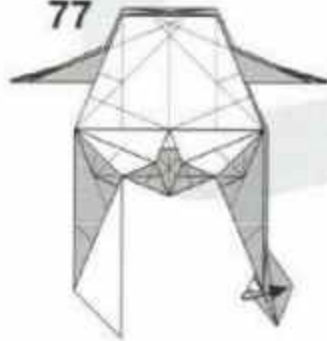

78

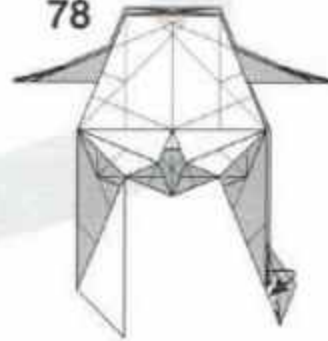

70

46-49

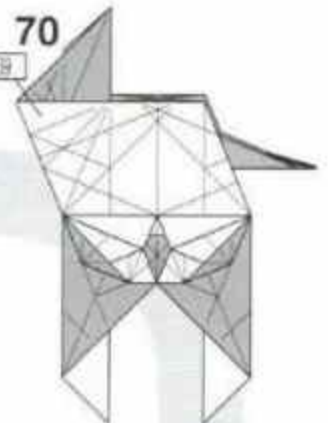

반대쪽도 46-69를 반복합니다.

73

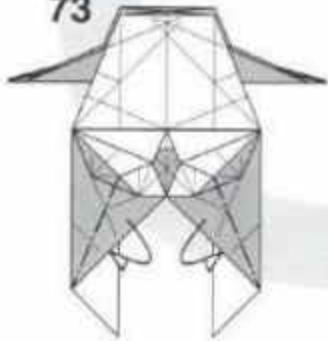

뒤로 접습니다.

72

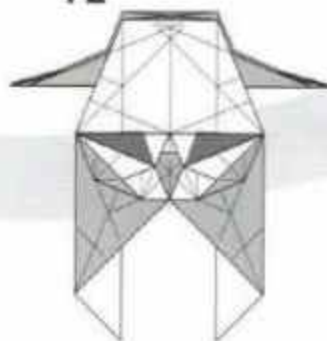

71

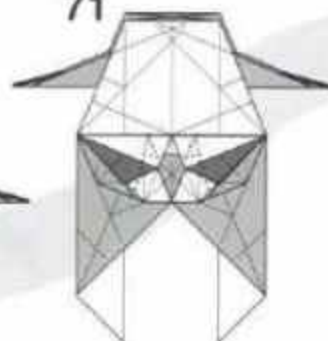

42에서 생긴 내부 각을 위로 올립니다.

69



65



66



67



68



반대쪽도 60-62를 반복합니다.

80



펼칩니다.

81

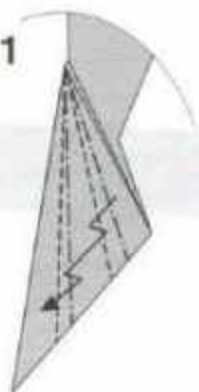

약간의 각도를 주며
계단접기합니다.

83



84



85



90

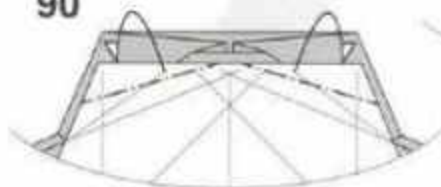

약간의 간격을 두고
뒤로 넘겨 접습니다.

89



합몰접기
(closed sink)

86

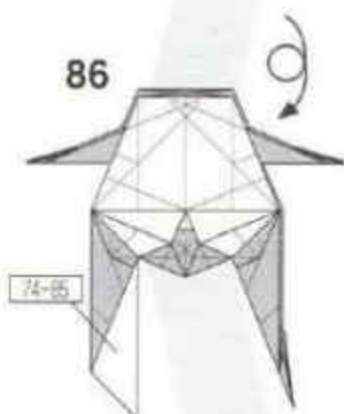

반대쪽도 74-85를 반복합니다.

91



88의 선대로 뒤로 넘겨 접습니다.

88



접었다면 선을 넘니다.

87

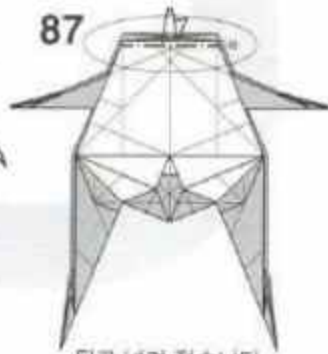

뒤로 넘겨 접습니다.

92

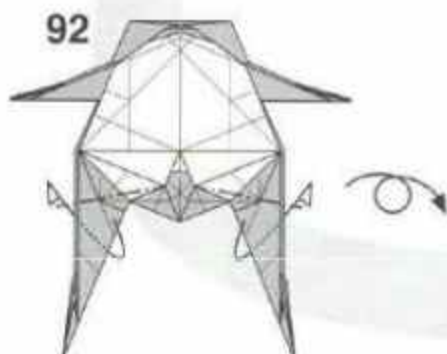

다리를 뒤로 넘겨 접고
고개를 뒤로 넘겨 접습니다.

93

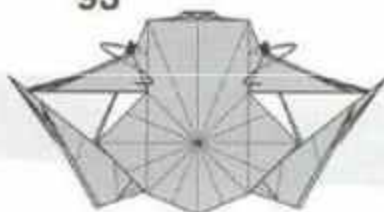

안쪽으로 넣어 숨깁니다.

94

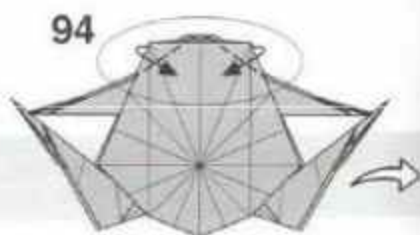

88의 선안을 앞으로 접습니다.

103

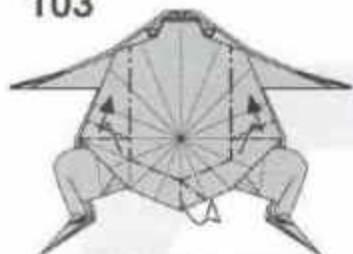

앞면 몸통을 일체로 만들지만
맨 뒤 한장은 접지 않습니다.

102

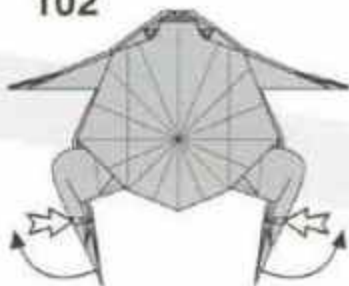

101



다리를 꺾습니다.

104

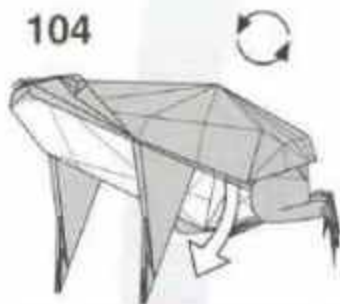

안에 펼쳐있는 한장을 밖으로 꺼냅니다.

100



99



양쪽 붓구멍을 만들어줍니다.

105

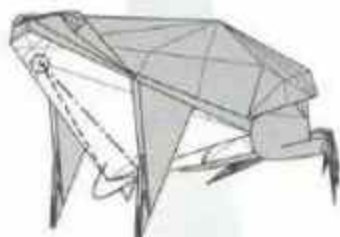

배를 꺾어 접습니다.

107

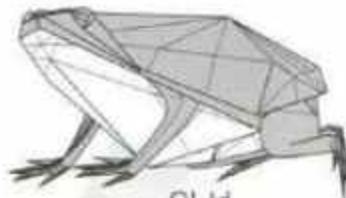

완성

106

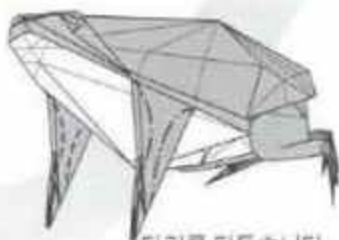

다리를 다듬습니다.

98



약간만 앞으로 접습니다.

97



눈꺼풀을 만듭니다.

95



96



2겹 중 안쪽을 비스듬히 접어
눈을 만듭니다.

청설모

Korean squirrel

- Creator : 장용익(Jang Yong Ik)
- Diagram : 장용익(Jang Yong Ik)
- Size : 60cm x 60cm

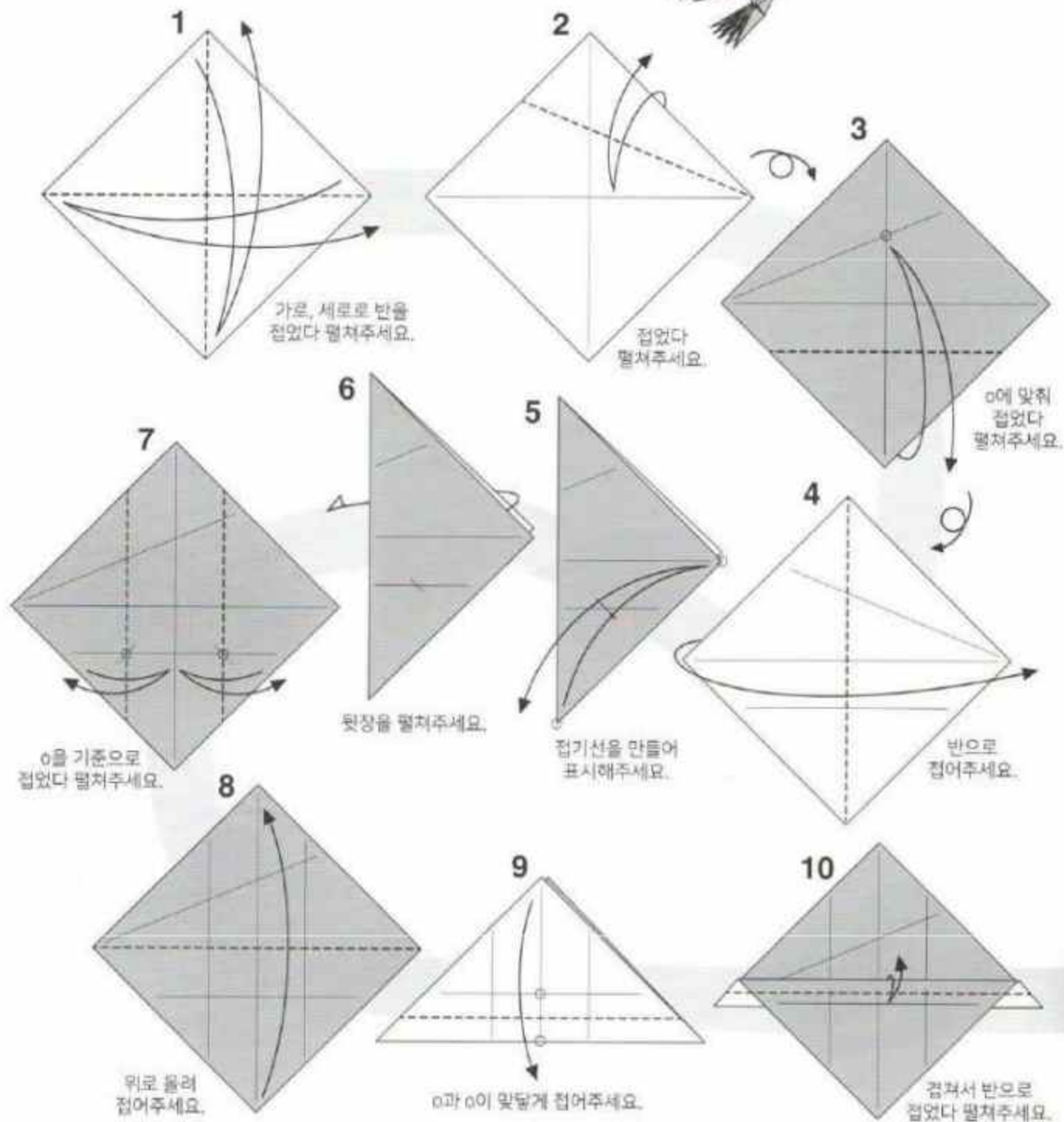
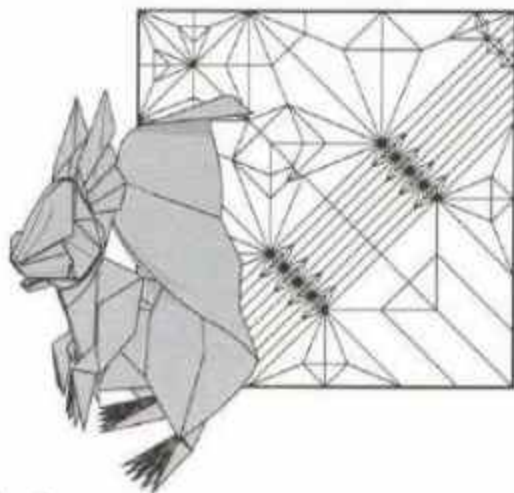

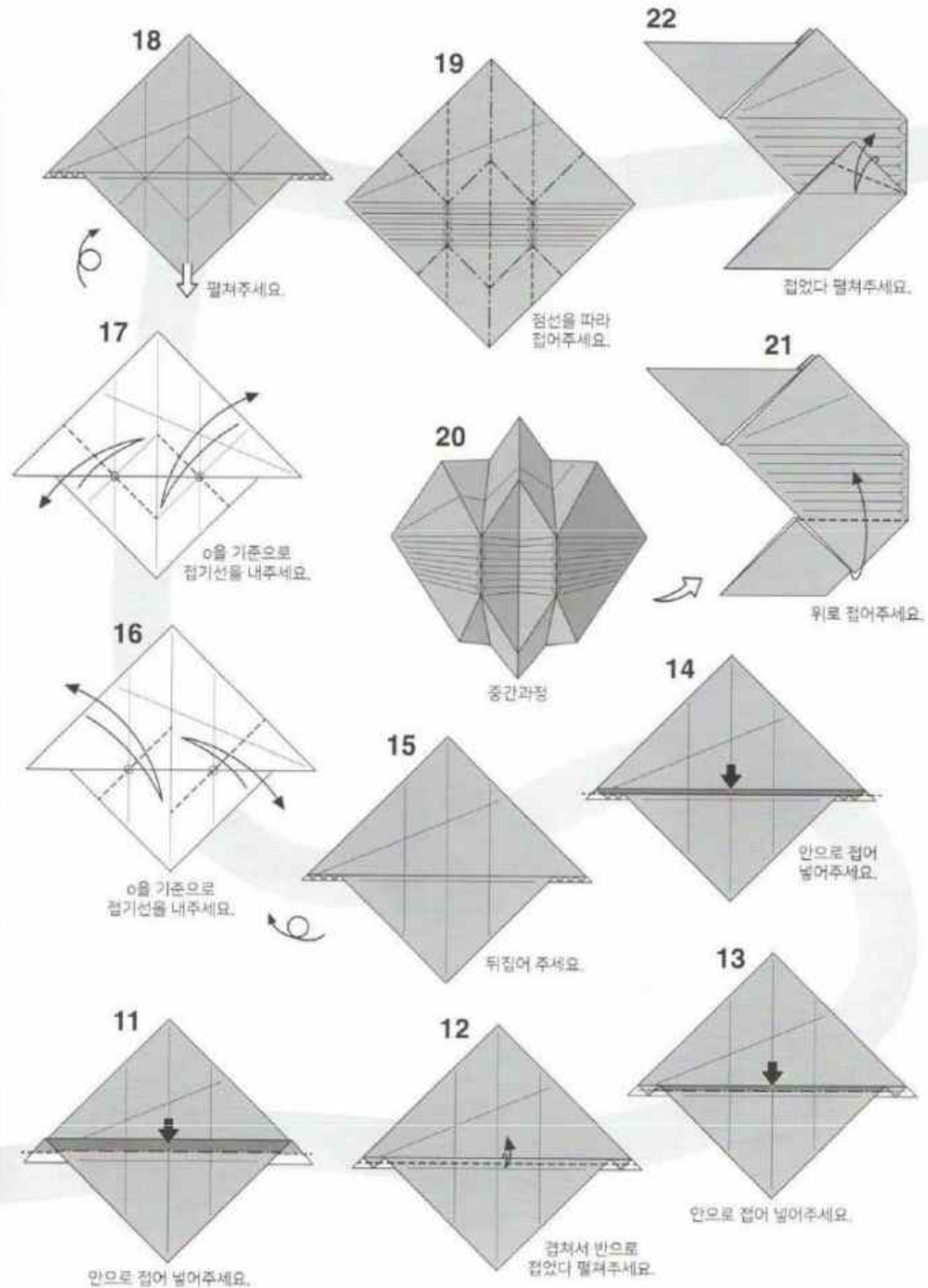

23

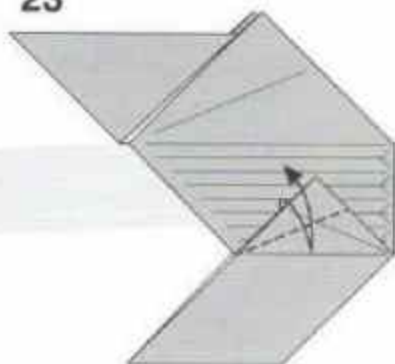

접었다 펼쳐주세요.

24

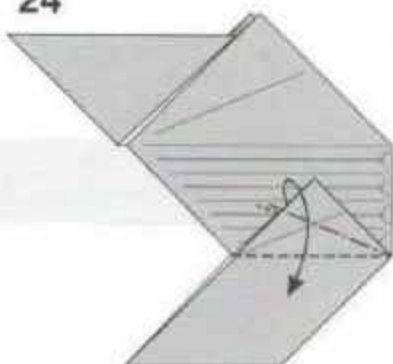

펼쳐서 눌러주세요.

25

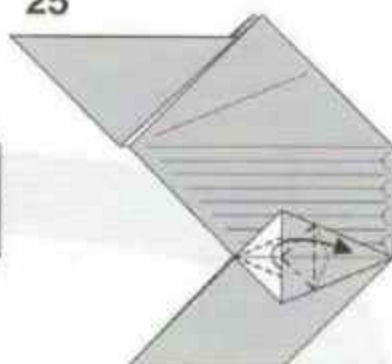

오른쪽으로 빗겨 접어주세요.

29

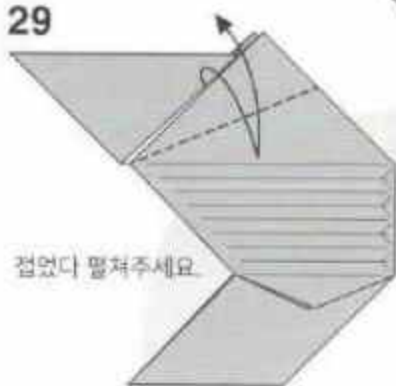

접었다 펼쳐주세요.

28

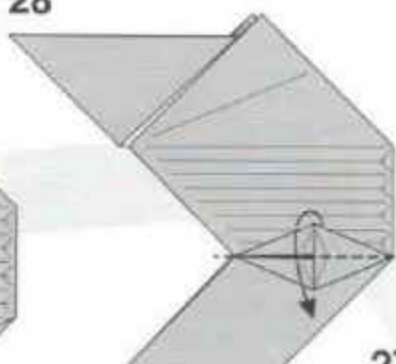

아래로 접어주세요.

26

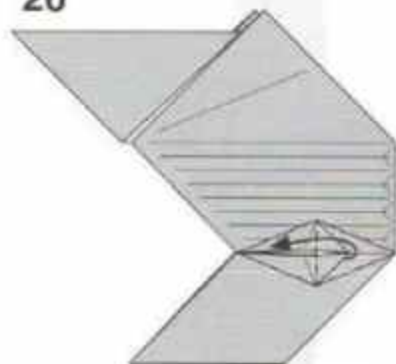

왼쪽으로 접어주세요.

27

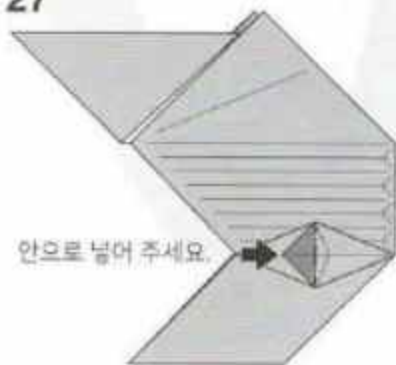

안으로 눌러주세요.

30

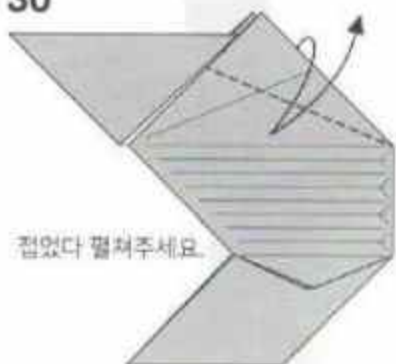

접었다 펼쳐주세요.

32

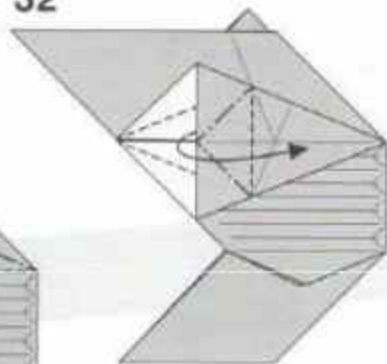

오른쪽으로 빗겨 접어주세요.

33

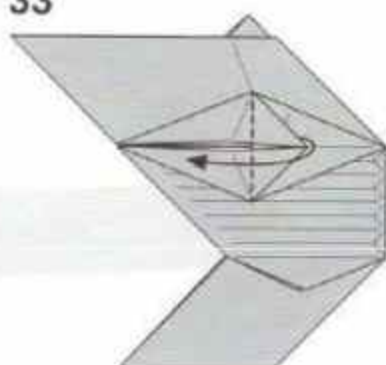

왼쪽으로 접어주세요.

31

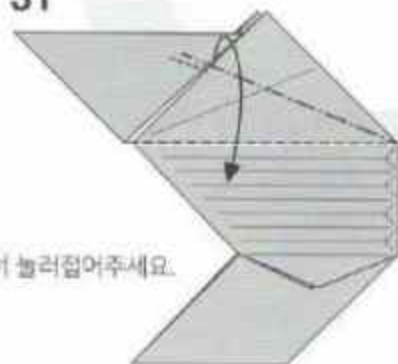

펼쳐서 눌러주세요.

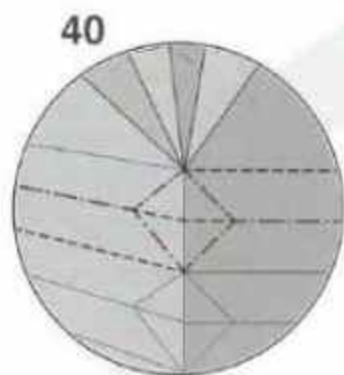

40
점선을 따라 접어주세요.
(반대쪽과 동시진행)

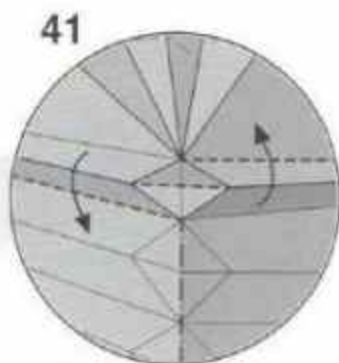

41
점선을 따라 비틀어주세요.

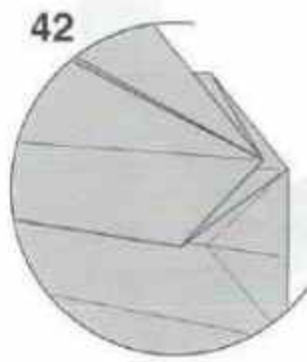

접힌모습

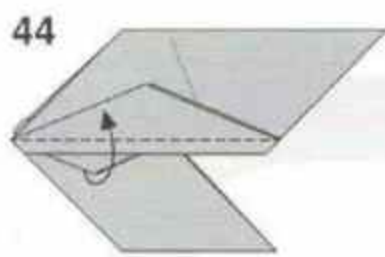

44
올려 접어주세요.

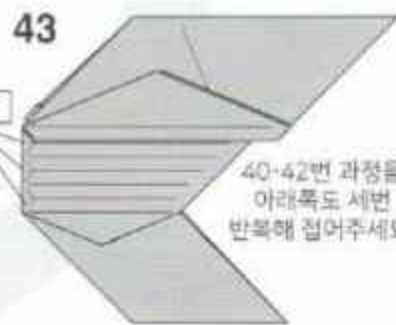

43
40-42번 과정을
아래쪽도 세번
반복해 접어주세요.

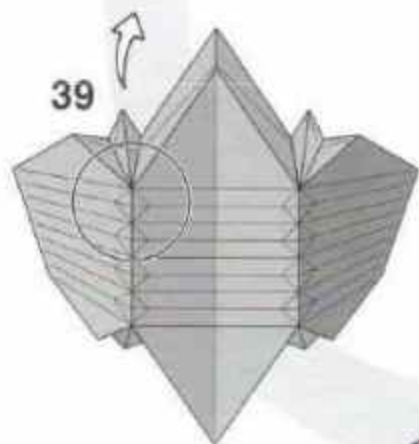

39

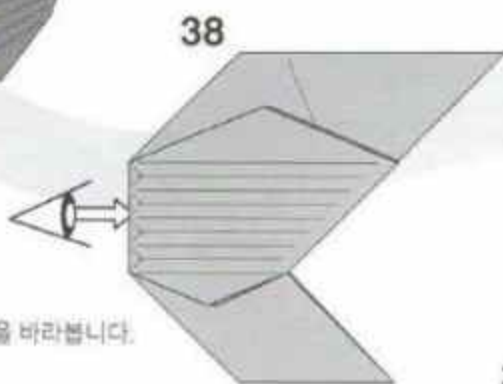

38

안쪽을 따라합니다.

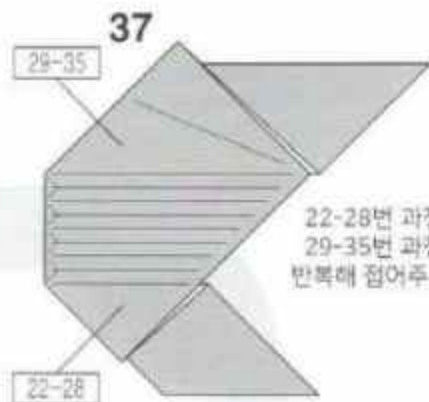

37

22-28번 과정과
29-35번 과정을
반복해 접어주세요.

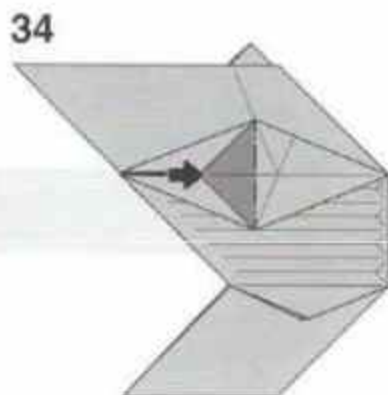

34

안으로 넣어 주세요.

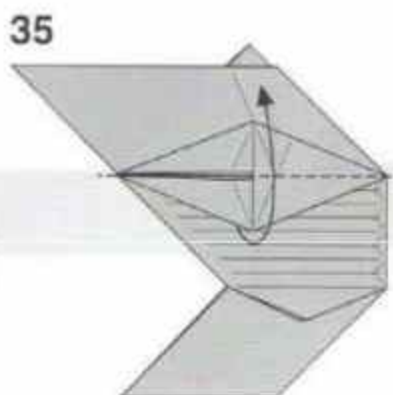

35

위로 접어주세요.

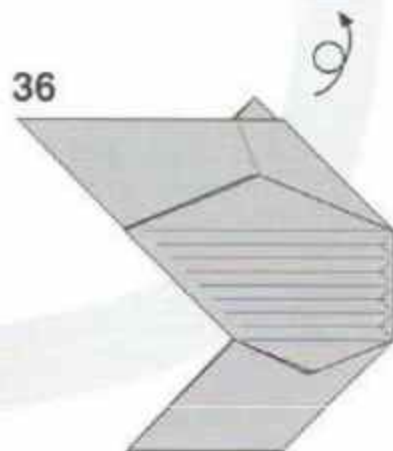

36

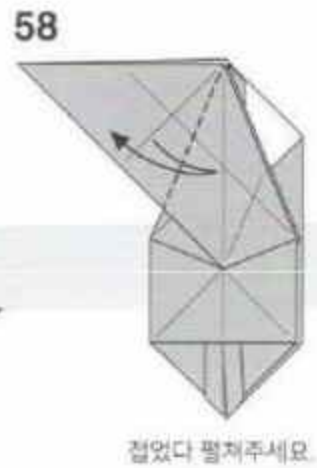
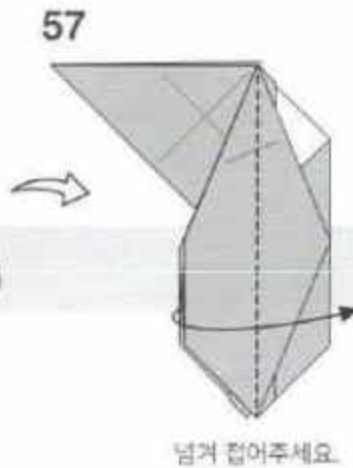
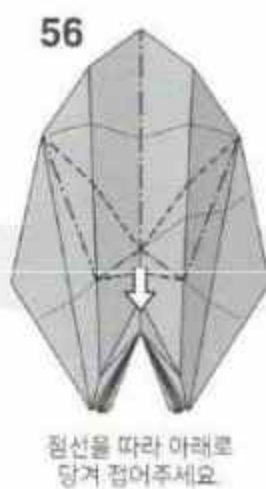
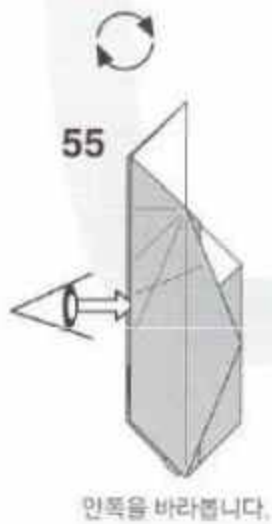
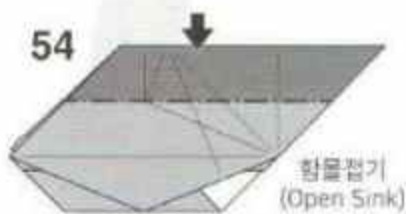
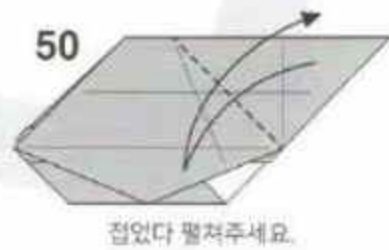
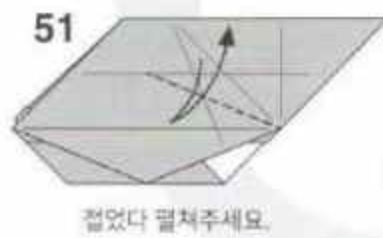
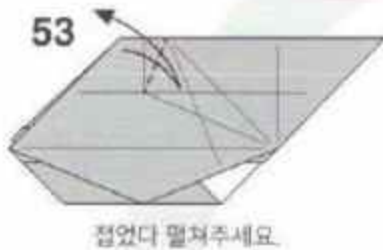
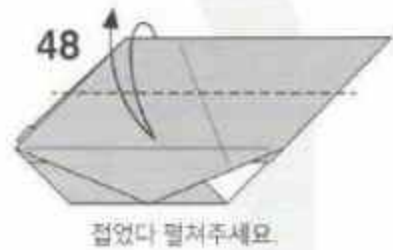
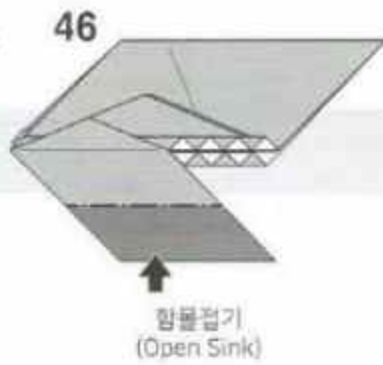

68



내려 잡아주세요.

69



틀려 잡아주세요.

70



안으로 넣어주세요.

71



아래로 당기는 동시에
왼쪽으로도 번개 잡아주세요.

67



안쪽을 펼쳐
잡아주세요.

66

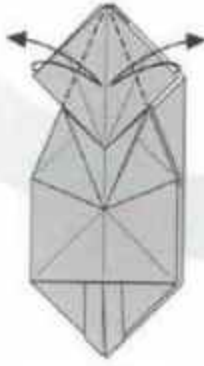

중심선에 맞춰
잡았다 펼쳐주세요.

65

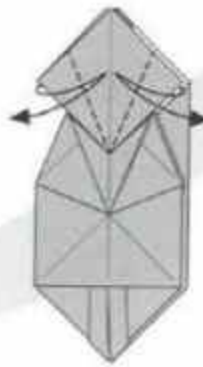

중앙선을 맞춰
잡았다 펼쳐주세요.

64

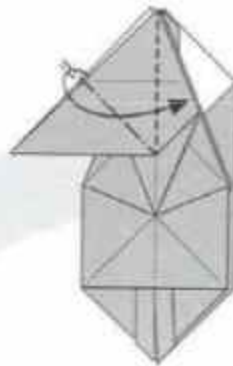

안쪽을 맞춰
잡아주세요.

63

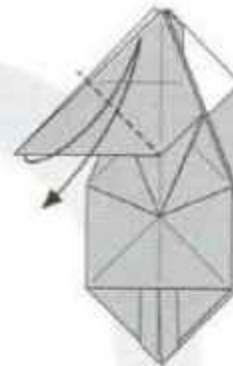

잡았다 펼쳐주세요.

62

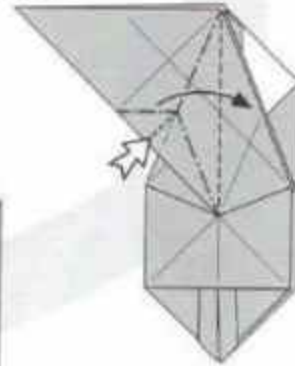

아래쪽을 눌러 오른쪽으로
번개 잡아주세요.

59

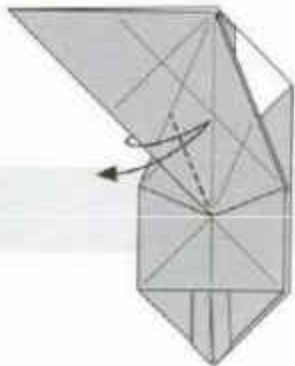

잡았다 펼쳐주세요.

60

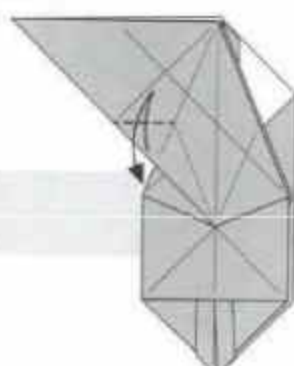

잡았다 펼쳐주세요.

61

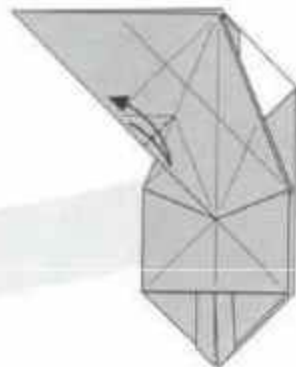

잡았다 펼쳐주세요.

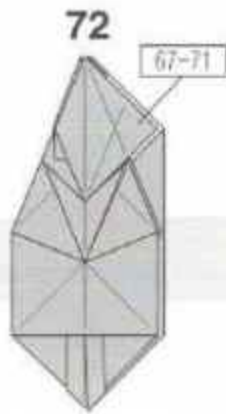

67-71번 과정을 반복해 접어주세요.



내려 접어주세요.



대각선으로 올려 접어주세요.



왼쪽으로 남겨 접어주세요.



핀었다 펼쳐주세요.

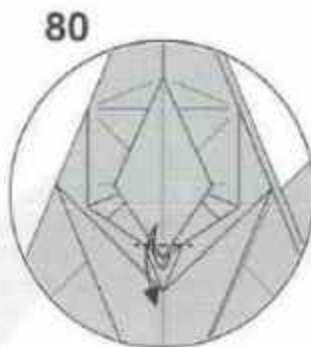

핀 부분을 펼쳤다가 펼쳐주세요.



안쪽을 펼쳐서 올려 접어주세요.



접었다 펼쳐주세요.

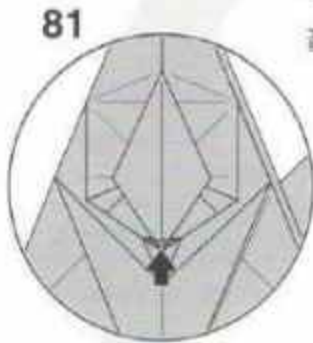

합몰집기 (Open Sink)

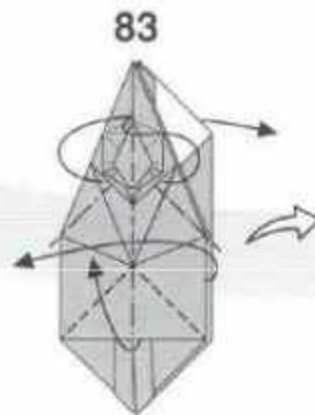
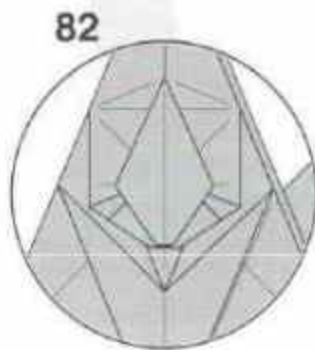

왼쪽으로 편지 접기 행사의 약해쪽을 올려 잡고, 뒷부분을 대각 선으로 끌어 위로 펼치주세요.

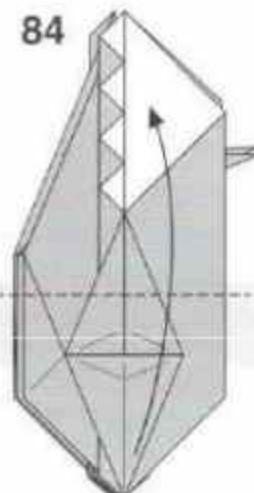

위로 올려 접어주세요.

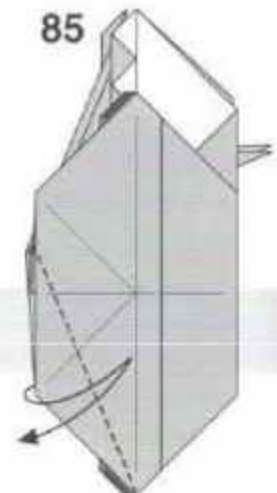

접었다 펼쳐주세요.

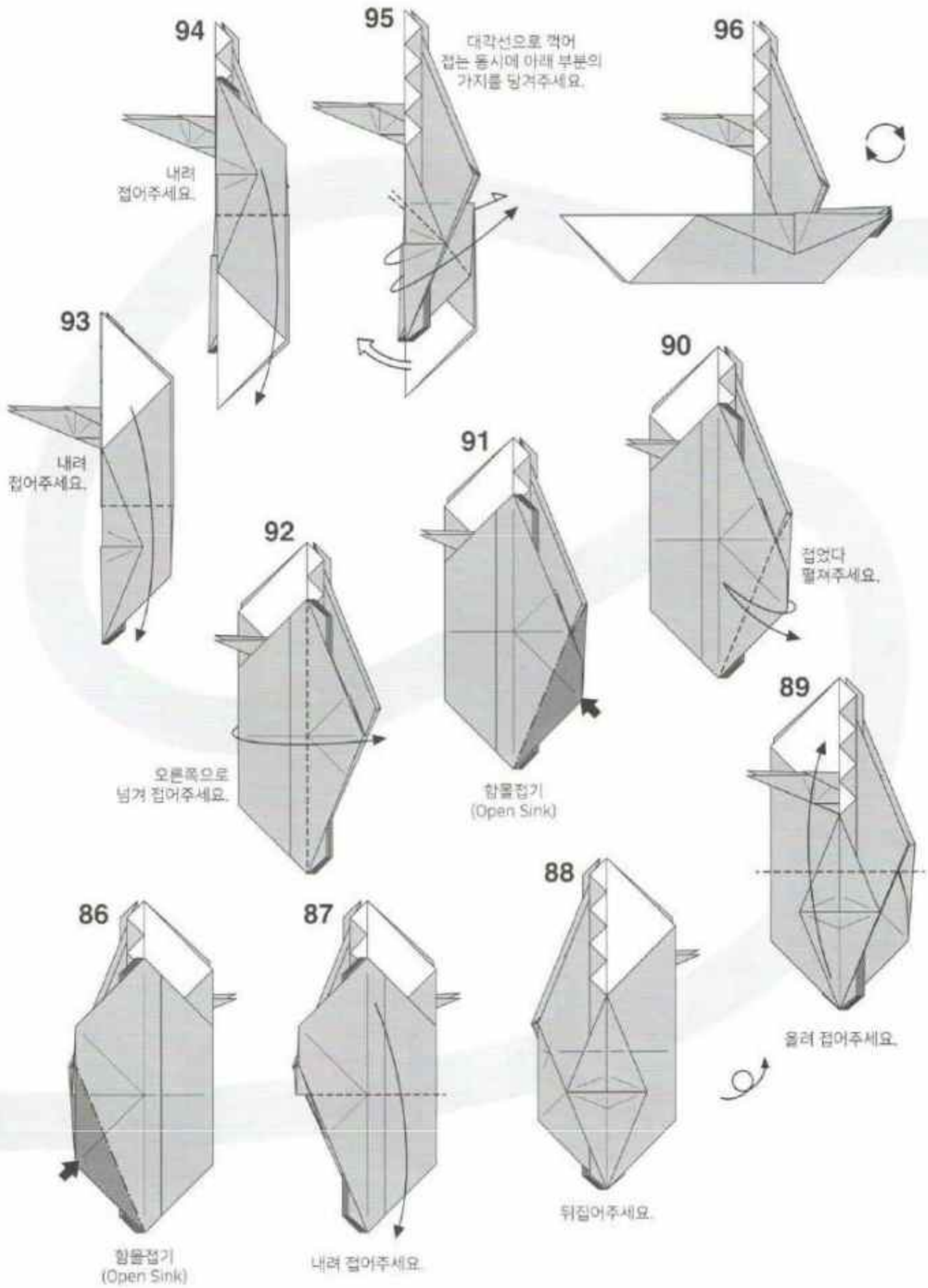

97

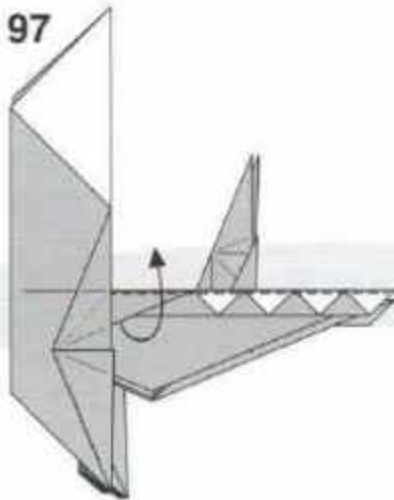

주름을 위로 올리는 동시에
안쪽에 숨겨진 종이층을
꺼내주세요.

98

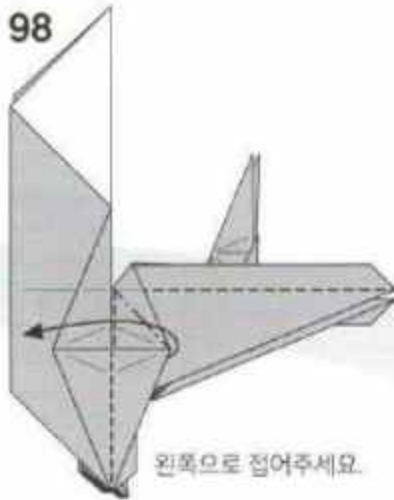

왼쪽으로 접어주세요.

99

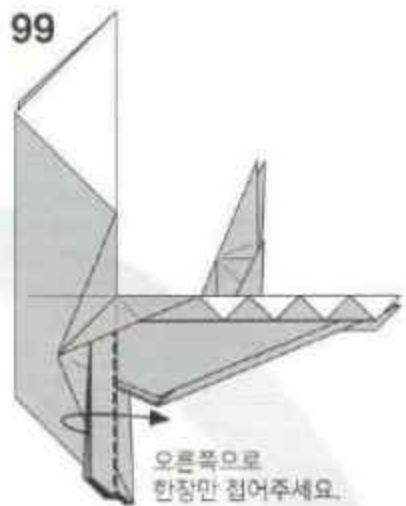

오른쪽으로
한장만 접어주세요.

101

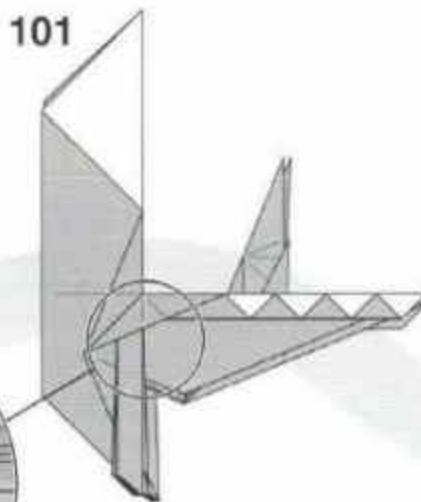

102

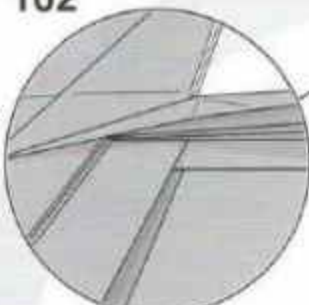

중간과정

100

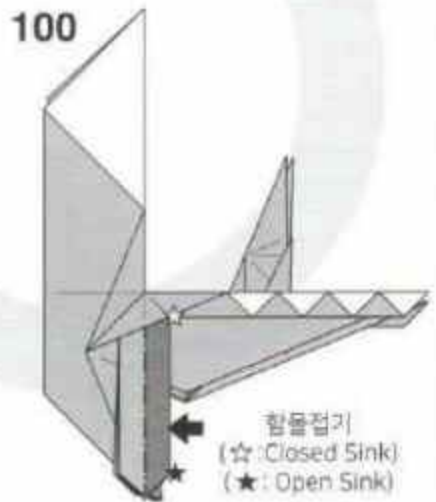

함몰접기
(☆: Closed Sink)
(★: Open Sink)

103

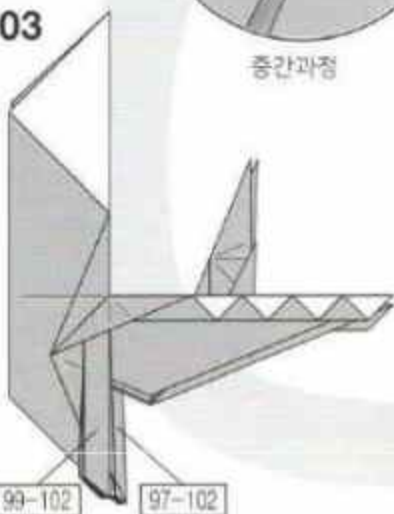

남은 부분과 뒷부분을
반복해 접어주세요.

104

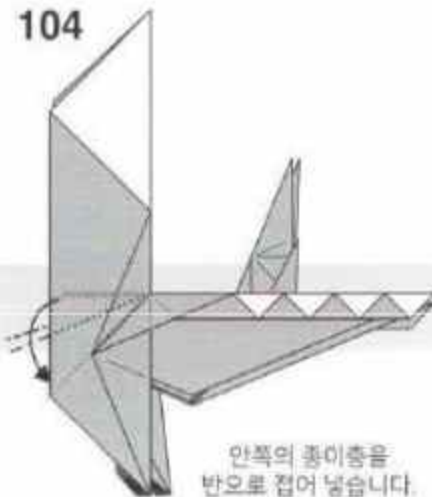

안쪽의 종이층을
반으로 접어 넣습니다.

105



넘겨 접어주세요.

113

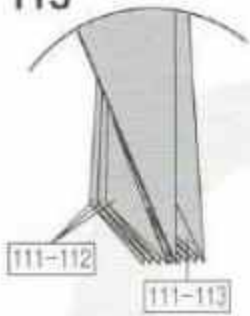

나머지 부분도 반복해 접어주세요.

114

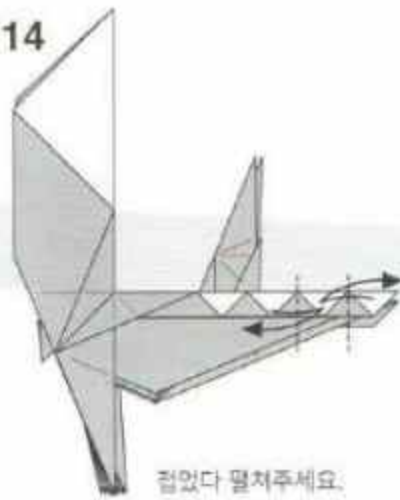

접었다 펼쳐주세요.

115

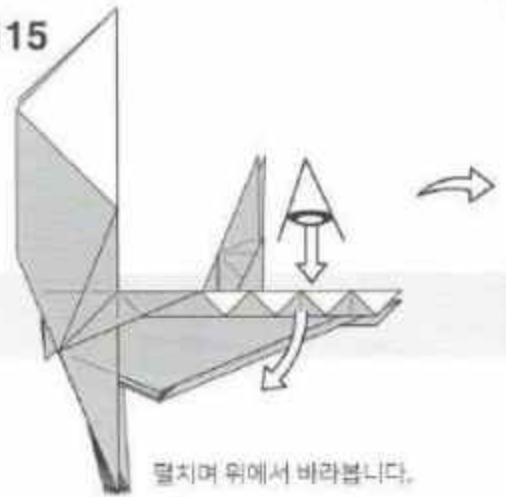

펼치며 위에서 바라봅니다.

112



함몰접기
(Open Sink)

111



접었다
펼쳐주세요.

110

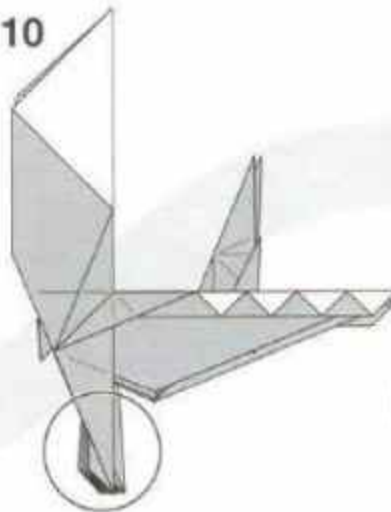

109



105-108

105-108번 과정을
반복해 접어주세요.

106

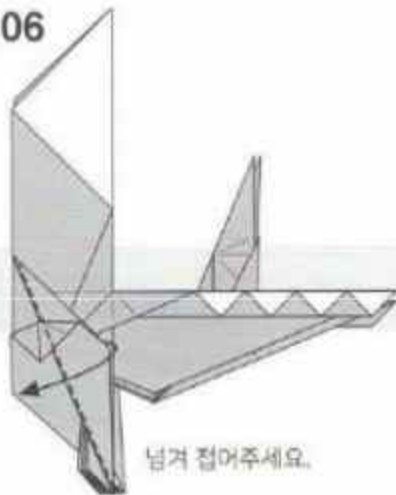

넘겨 접어주세요.

107

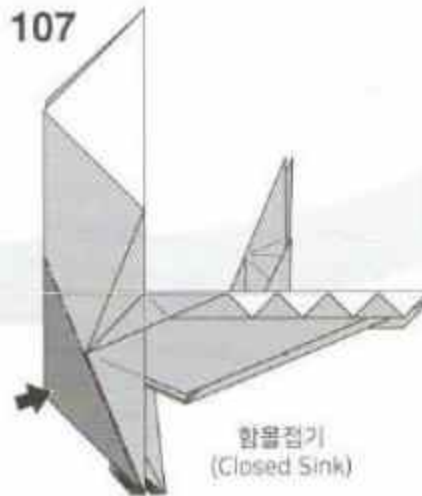

함몰접기
(Closed Sink)

108

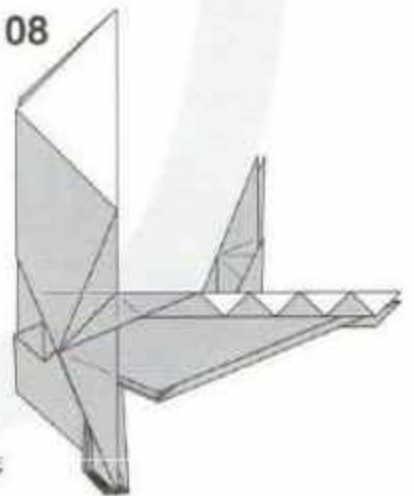

안쪽이 구겨지지 않도록
깔끔하게 넣어 마무리해주세요.

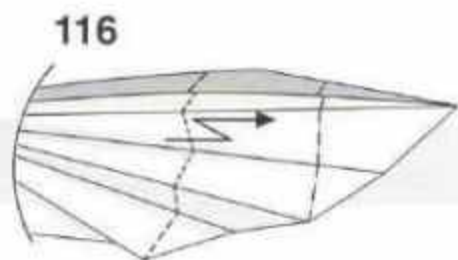

114번에서 만든 선을 기준으로
계단접기 해주세요.

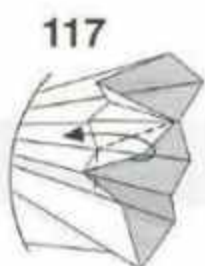

모서리에 맞춰
당겨잡아주세요.

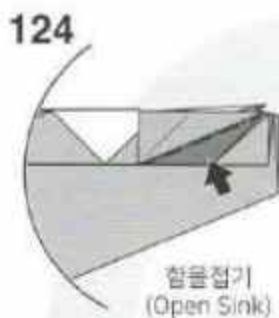
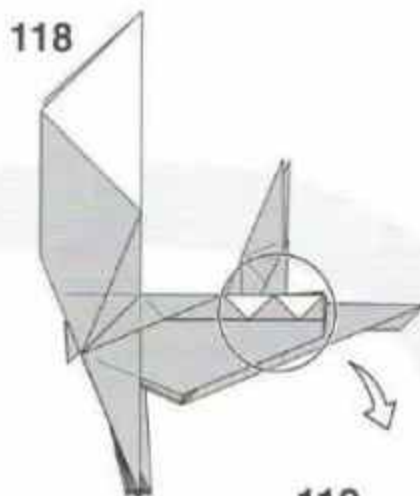

함몰접기
(Open Sink)

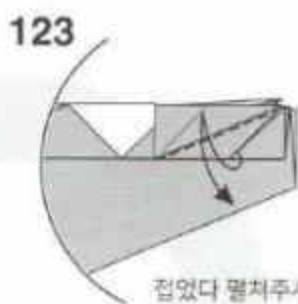

접었다 펼쳐주세요.

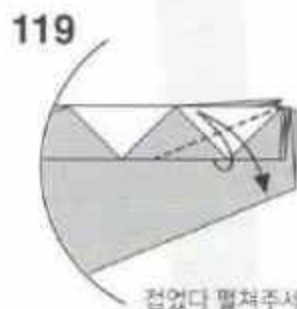

접었다 펼쳐주세요.

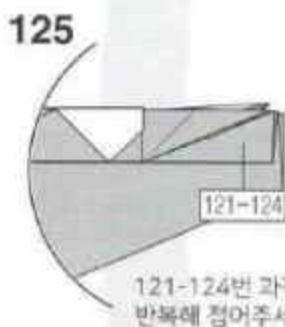

121-124번 과정을
반복해 접어주세요.



안쪽으로 집어 넣어주세요.

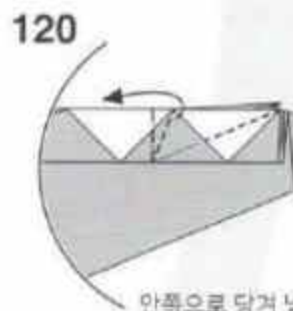

안쪽으로 당겨 넣어주세요.

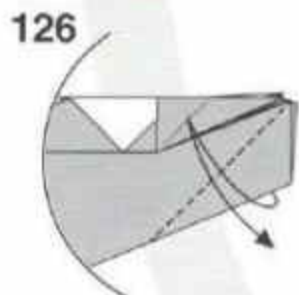

접었다 펼쳐주세요.

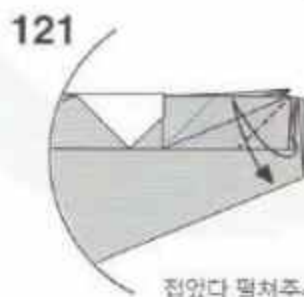

접었다 펼쳐주세요.



접었다 펼쳐주세요.



함몰접기
(Open Sink)



함몰접기
(Open Sink)

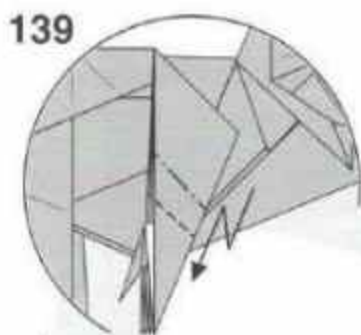

139

계단접기 해주세요.

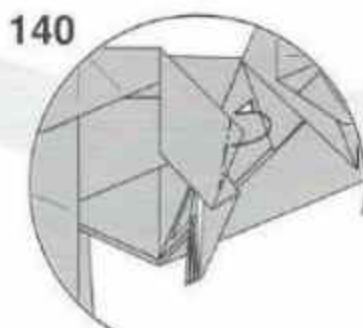

140

뒤로 넘겨 접어주세요.

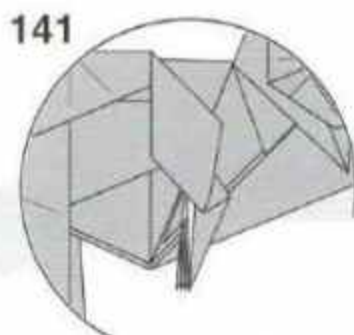

141

원하는 각도로 조절해주세요.

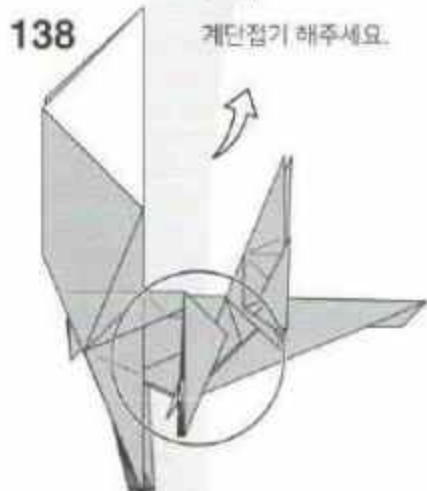

138

계단접기 해주세요.

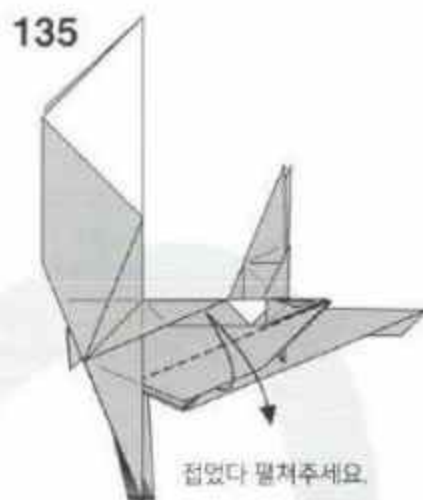

135

접었다 펼쳐주세요.

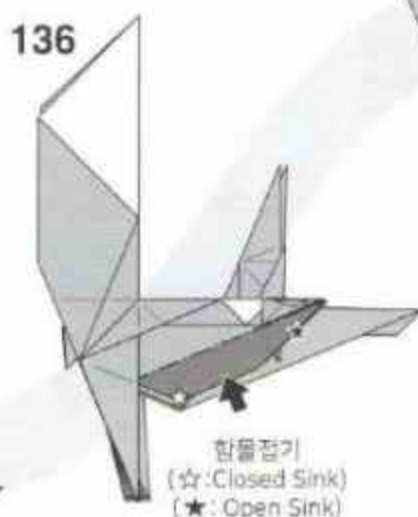

136

함몰접기
(☆: Closed Sink)
(★: Open Sink)

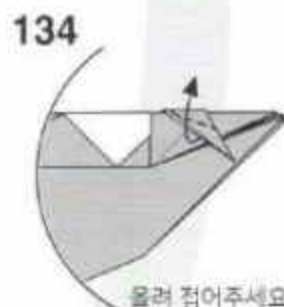

134

올려 접어주세요.

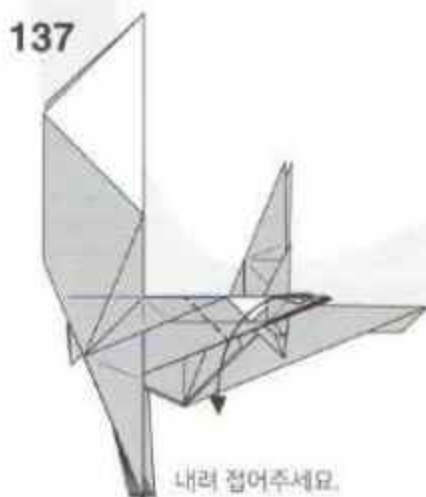

137

내려 접어주세요.

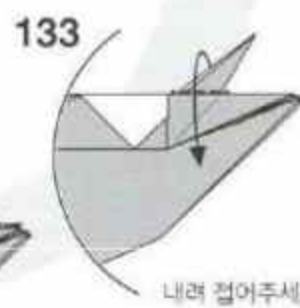

133

내려 접어주세요.

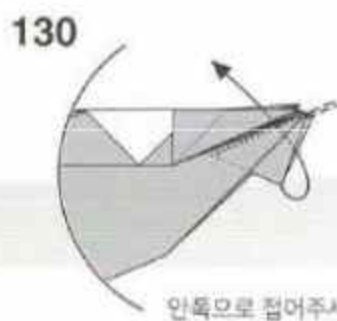

130

안쪽으로 접어주세요.

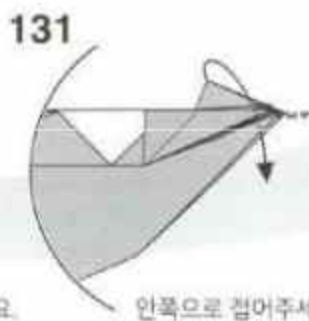

131

안쪽으로 접어주세요.

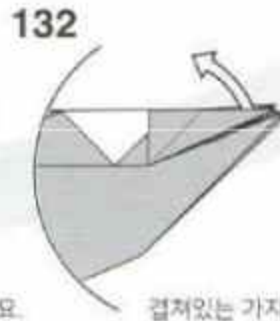

132

걸쳐있는 가지를 꺼내주세요.

142

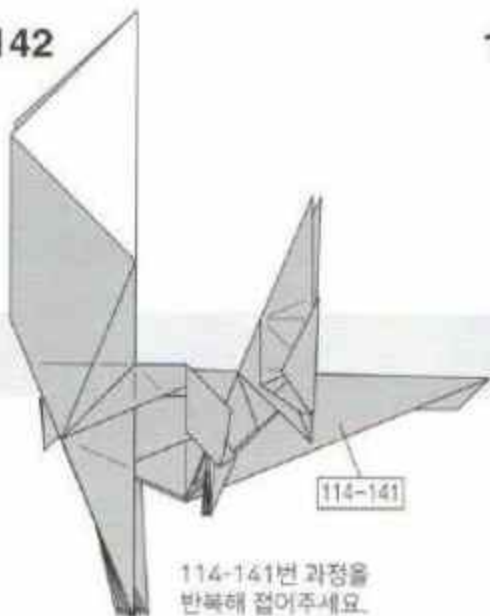

114-141번 과정을
반복해 접어주세요.

143

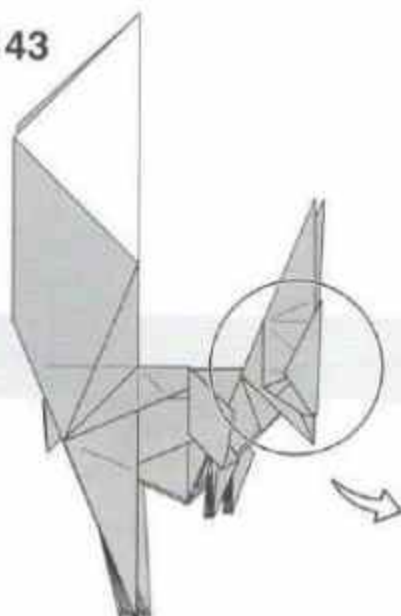

144



안으로 접어
넣어주세요.

145



비스듬히 밖으로
꺼내주세요.

149



앞부분을 접어 넣고
반대쪽도 똑같이 접어주세요.

148



노란 접어주세요.

147



위로 올려잡는 동시에
옆쪽있는 부분을 148번
모양으로 정리해주세요.

146



위로 비워 접어주세요.

150



오른쪽으로 넘겨주세요.

151

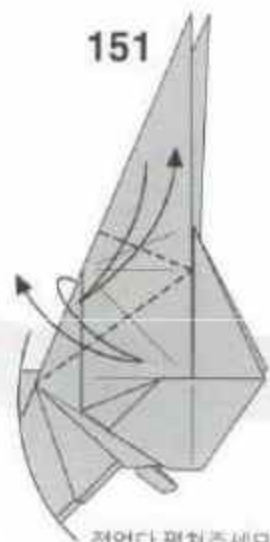

접었다 펼쳐주세요.

152

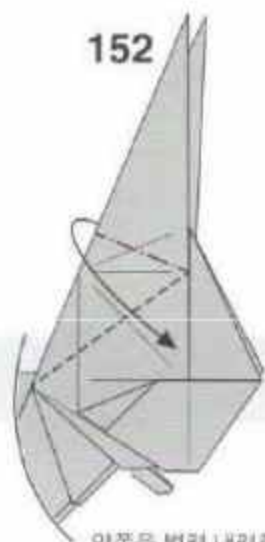

안쪽을 벌려 내려주세요.

153

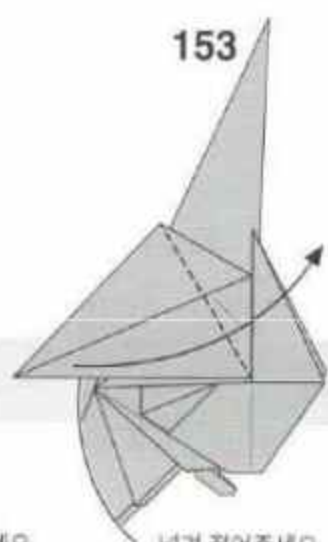

넘겨 접어주세요.

161

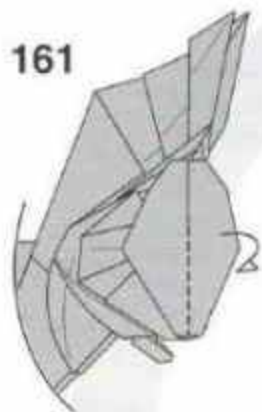

뒤로 넘겨
접어주세요.

162

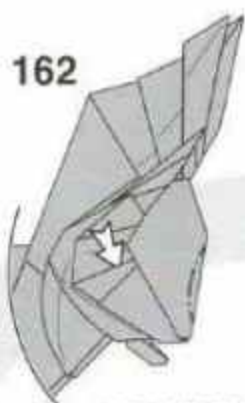

백색 부분을
뒤로 넘겨
다듬어주세요.

163

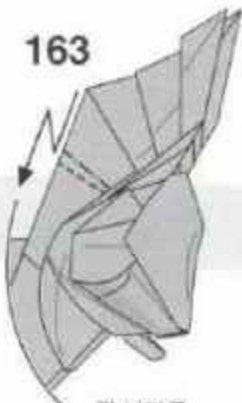

귀 부분을
계단잡기 해주세요.

164

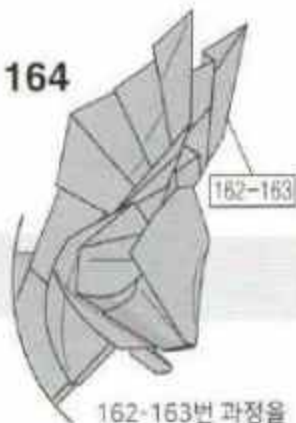

162-163번 과정을
반복해 접어주세요.

160

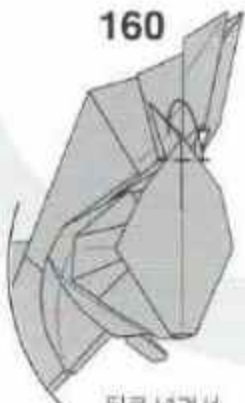

뒤로 넘겨서
고정해주세요.

159

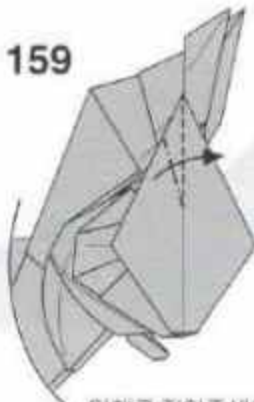

입체로 접어주세요.

158

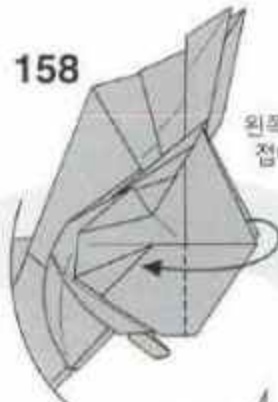

왼쪽으로 넘겨
접어주세요.

157

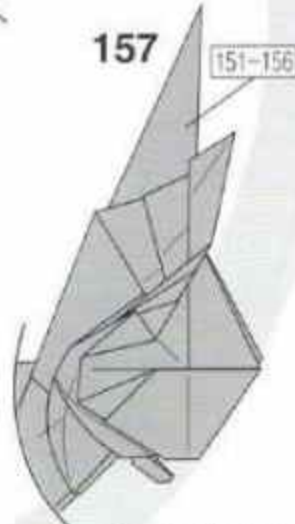

151-156번 과정을
반복해 접어주세요.

154

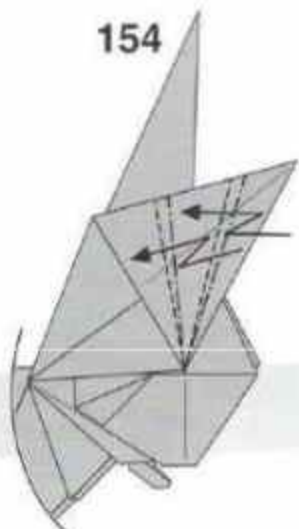

주름잡기를 해주세요.

155

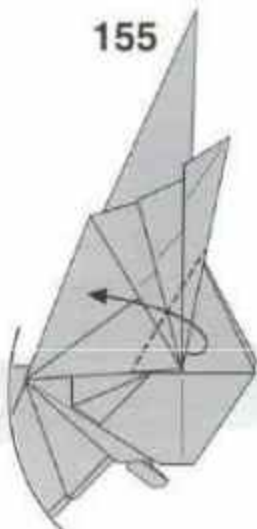

비스듬히 접어주세요.

156

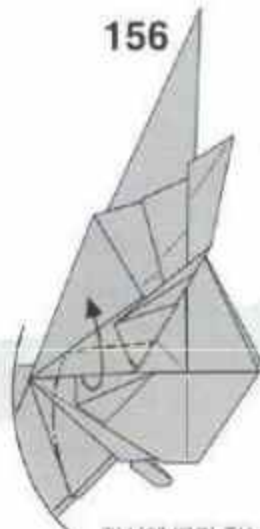

점선에 따라 접는 동시에
입체로 마무리 해주세요.

165



166

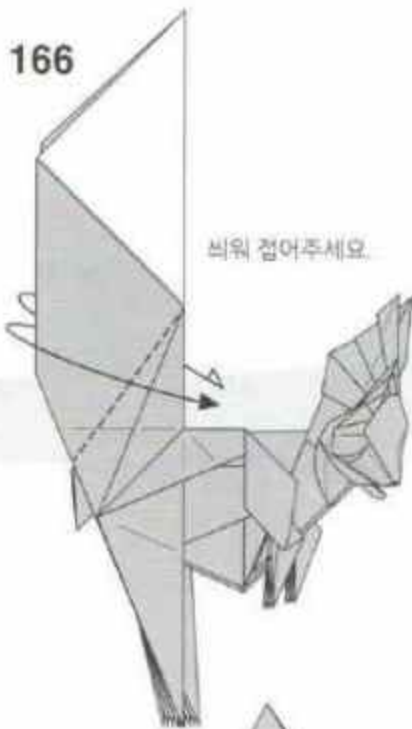

167

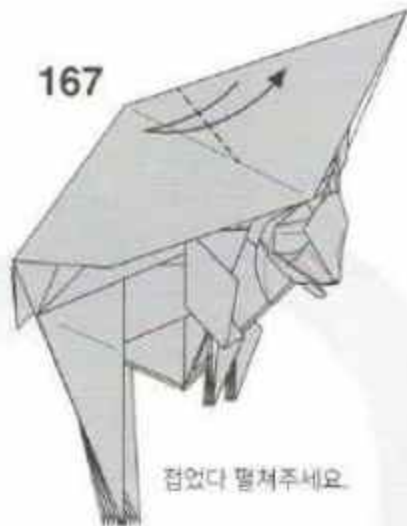

170

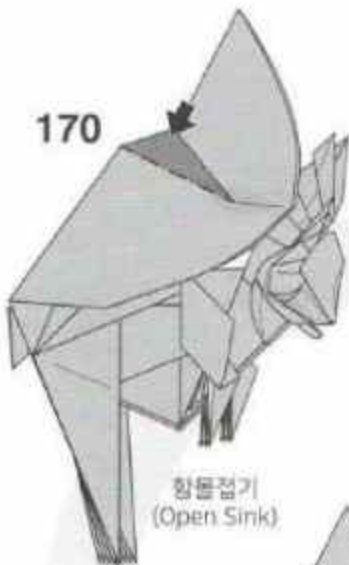

169

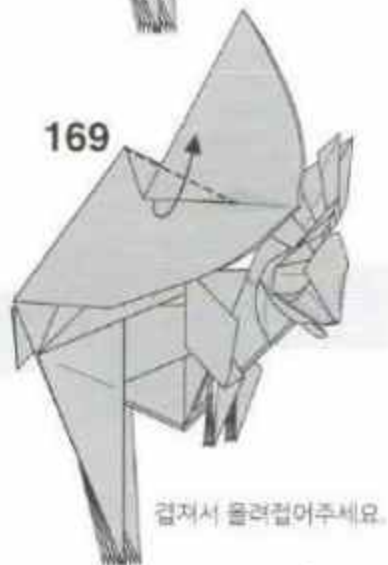

168

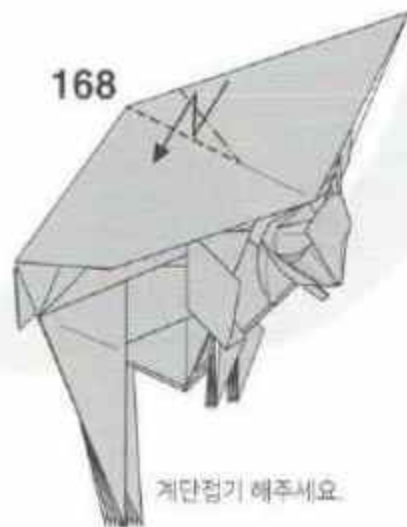

171

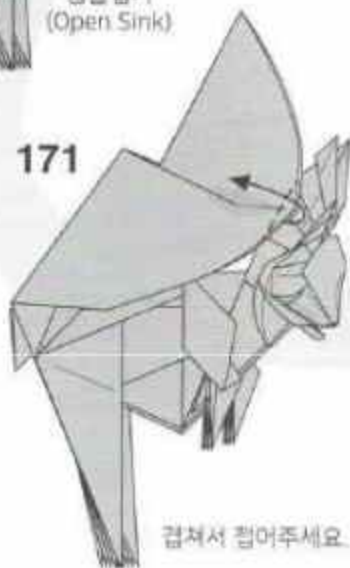

172

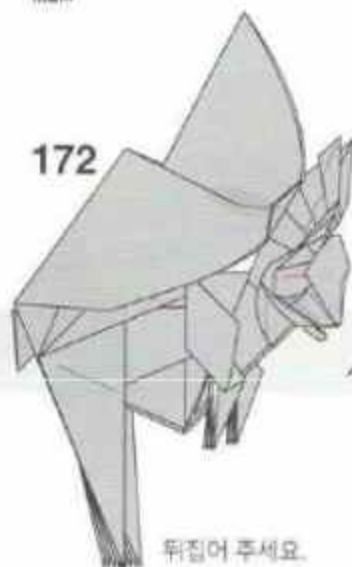

173

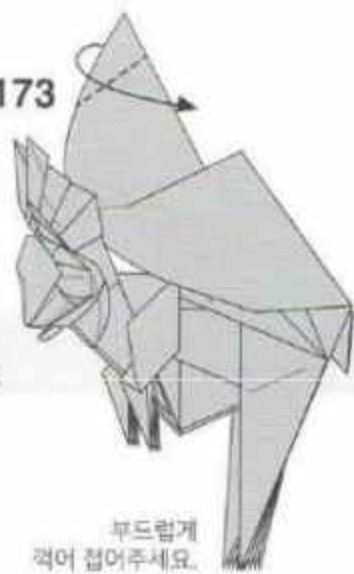

179

뛰어나선 부분을
뒤로 넘겨잡고
엉덩이 부분을 눌러잡어
입체로 만들어주세요.

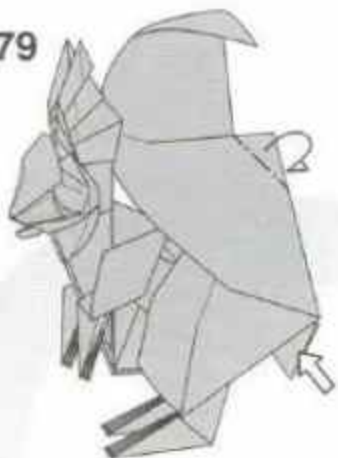

178

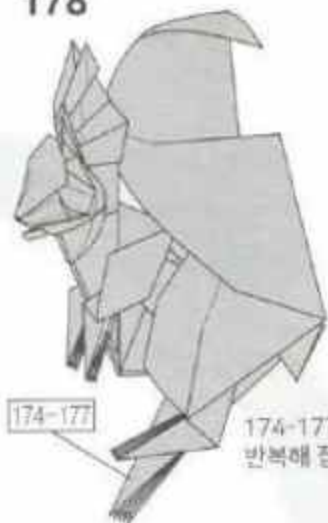

174-177번 과정을
반복해 잡아주세요.

180

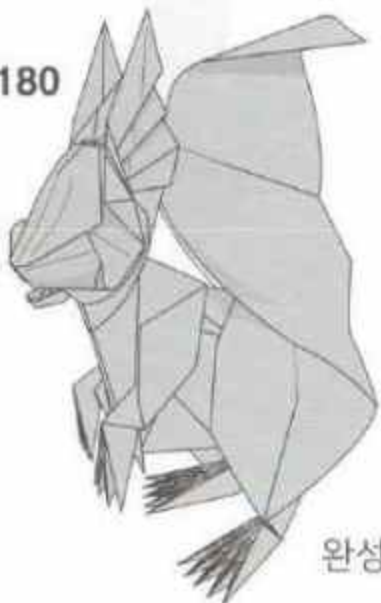

완성

177

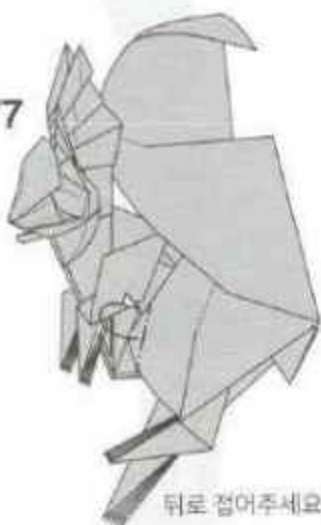

뒤로 잡아주세요.

176

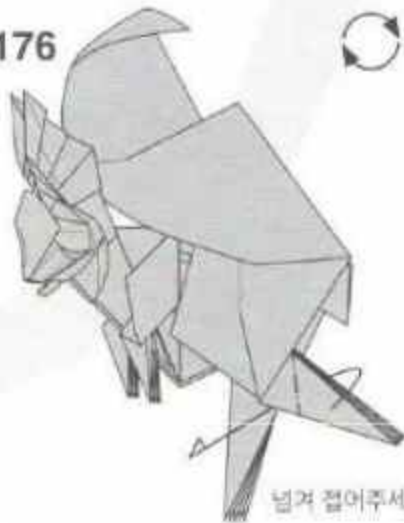

넘겨 잡아주세요.

174

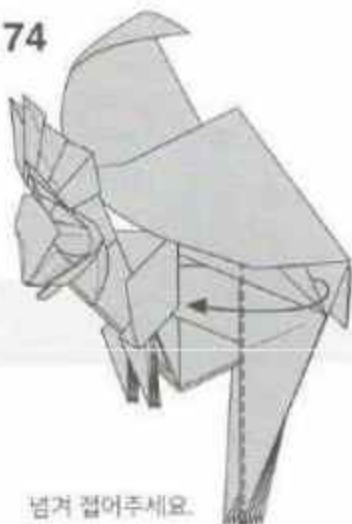

넘겨 잡아주세요.

175

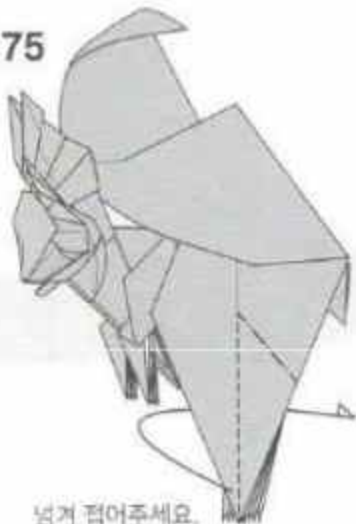

넘겨 잡아주세요.

알로사우루스

Allosaurus

- Creator : 정재일(Jeong Jae Il)
- Diagram : 정재일(Jeong Jae Il)
- Size : 70cm x 70cm

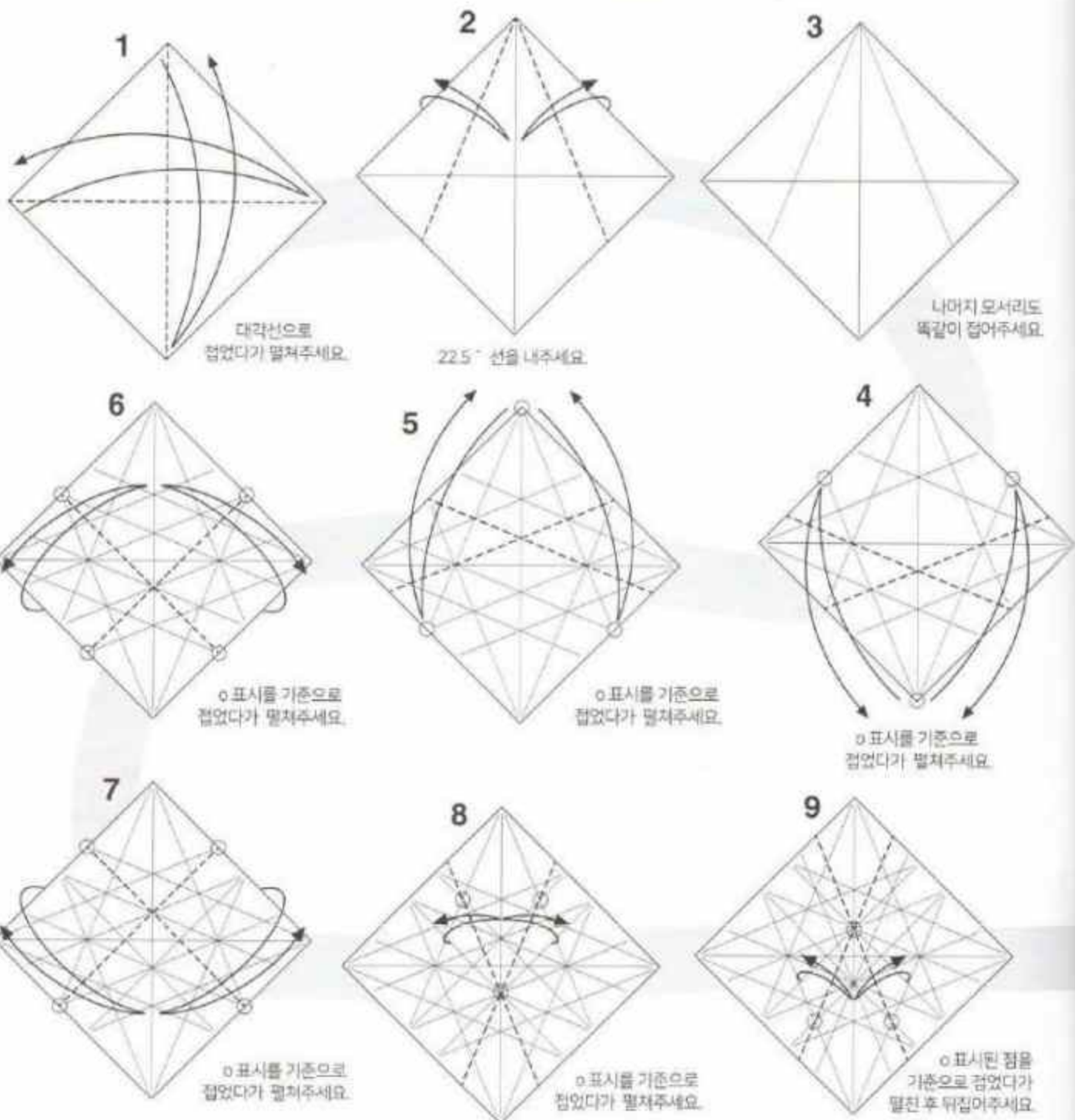
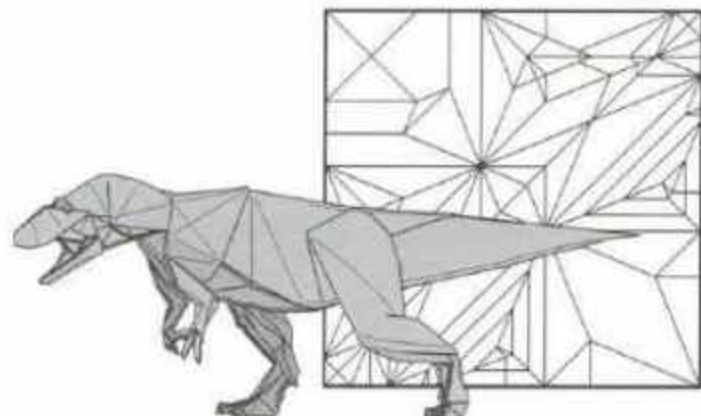

19

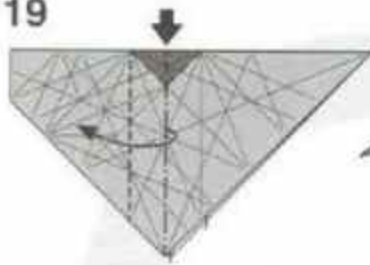

어두운 부분을 눌러주면서
정선대로 접어주세요.

20

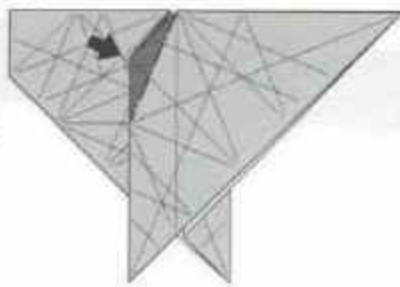

어두운 부분을
함몰접기 해주세요. (open sink)

21

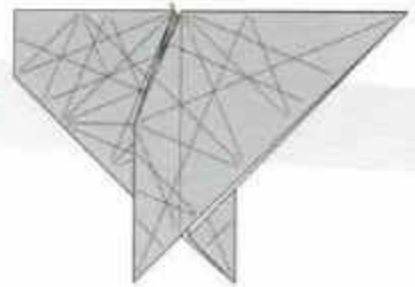

반대쪽도 똑같이 함몰접기 해주세요.

18

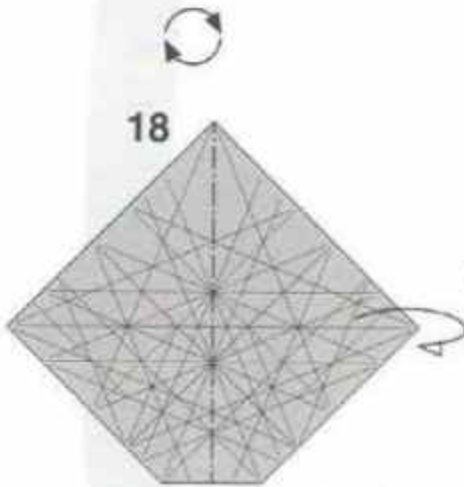

정선을 따라 접은 후 90° 회전해주세요.

15

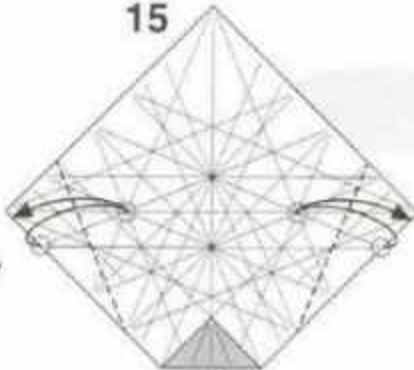

○ 표시를 기준으로
접었다가 펼쳐주세요.

14

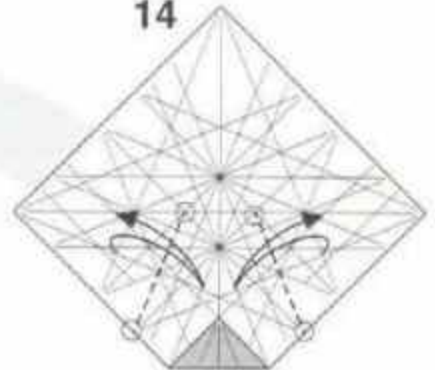

○ 표시를 기준으로
접었다가 펼쳐주세요.

17

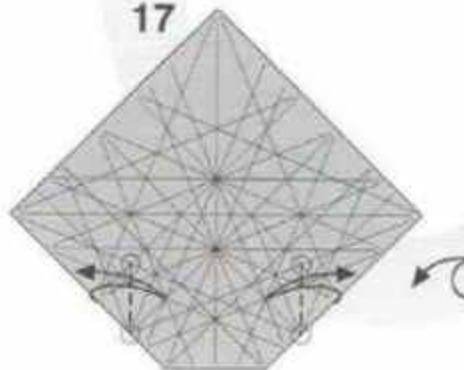

○ 표시를 기준으로
접었다가 펼쳐주세요.

16

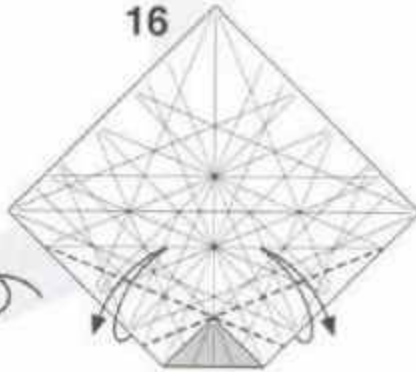

정선대로 접었다가
펼친 후 뒤집어주세요.

13

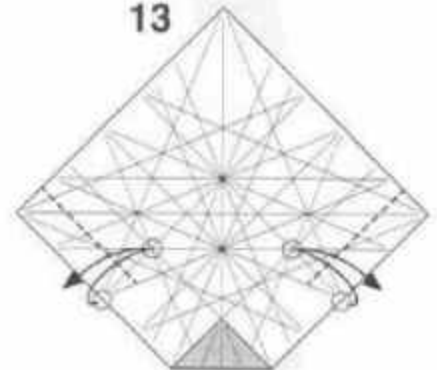

○ 표시를 기준으로
접었다가 펼쳐주세요.

10

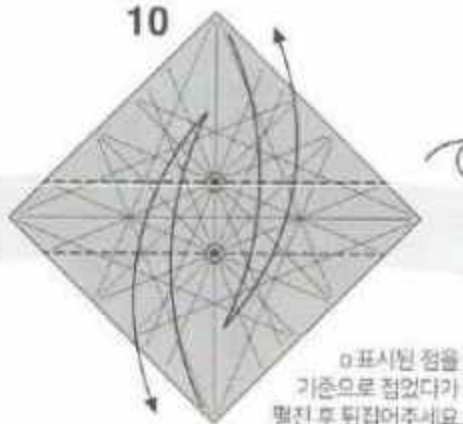

○ 표시된 점을
기준으로 접었다가
펼친 후 뒤집어주세요.

11

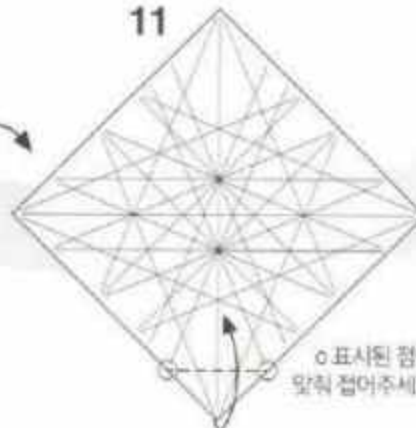

○ 표시된 점에
맞춰 접어주세요.

12

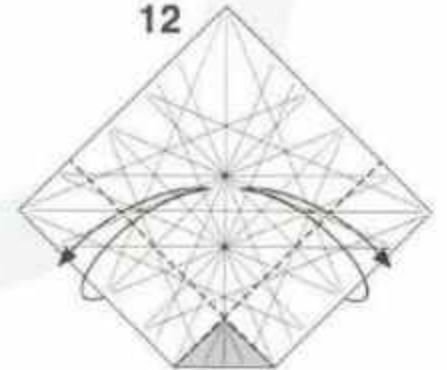

정선대로 접었다가 펼쳐주세요.

22

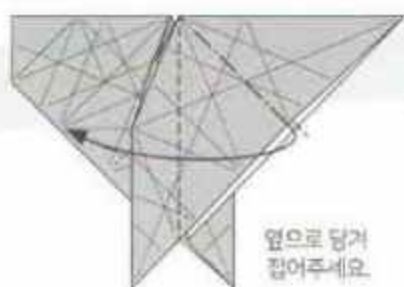

옆으로 당겨
접어주세요.

23

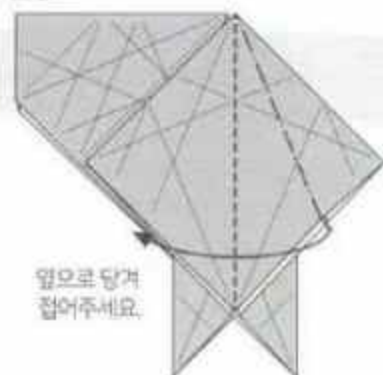

옆으로 당겨
접어주세요.

24



중선을 따라
접었다가
펼쳐주세요.

29

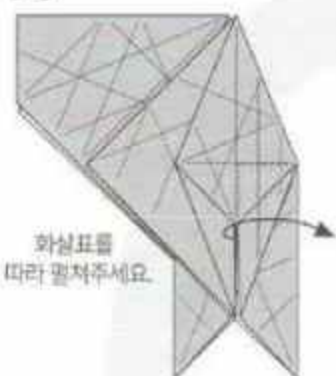

화살표를
따라 펼쳐주세요.

28



화살표를
따라
펼쳐주세요.

25

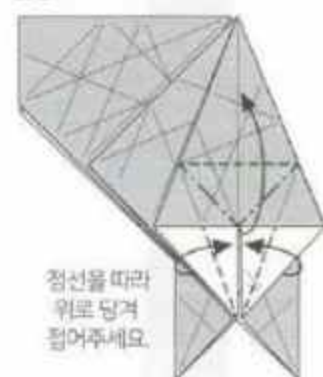

중선을 따라
위로 당겨
접어주세요.

30



o 표시를 기준으로
접었다가 펼쳐주세요.

27



o 표시를 기준으로
접었다가 펼쳐주세요.

26



화살표를 따라
아래로
접어주세요.

31



수평선으로
접었다가
펼쳐주세요.

32

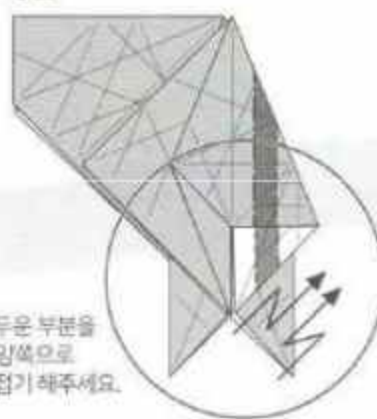

어두운 부분을
양쪽으로
계단접기 해주세요.

33

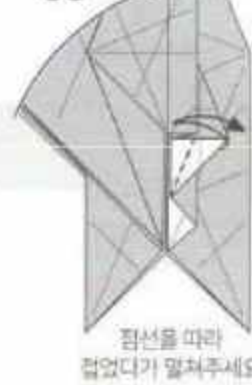

중선을 따라
접었다가 펼쳐주세요.

40



아래쪽의 한 겹을
맨 위로 꺼내주세요.

41



화살표를 따라
앞으로
잡어주세요.

43

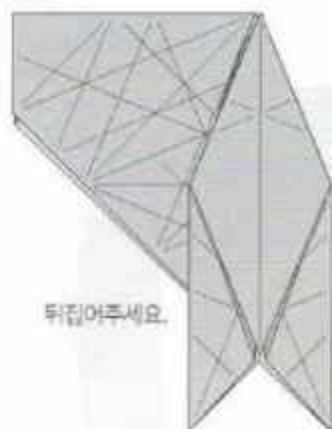

뒤집어주세요.

39

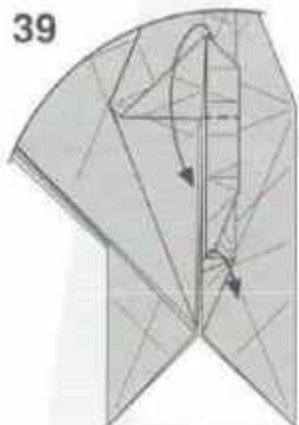

화살표를 따라서
아래로 잡어주세요.

42



반대쪽도
23-41을
반복해주세요.

38



화살표를 따라서
위로 당겨 잡어주세요.

37

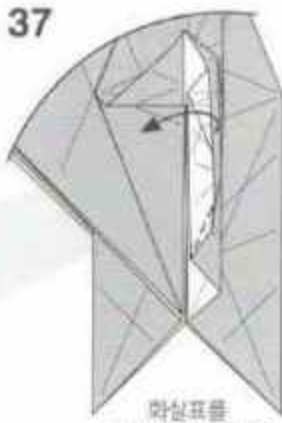

화살표를
따라잡어주세요.

36

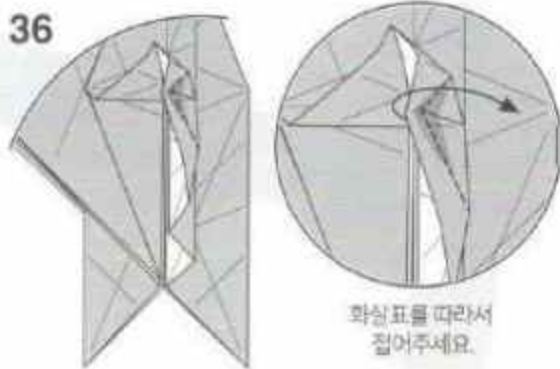

화살표를 따라서
잡어주세요.

34

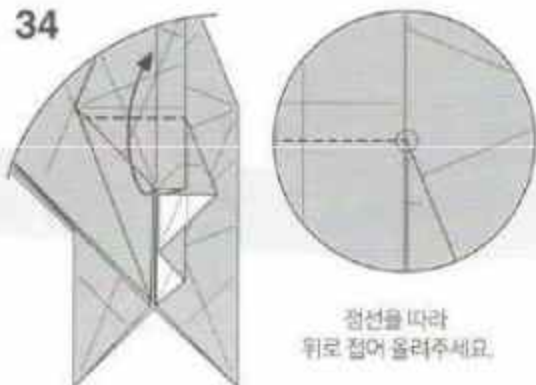

점선을 따라
위로 잡아 올려주세요.

35

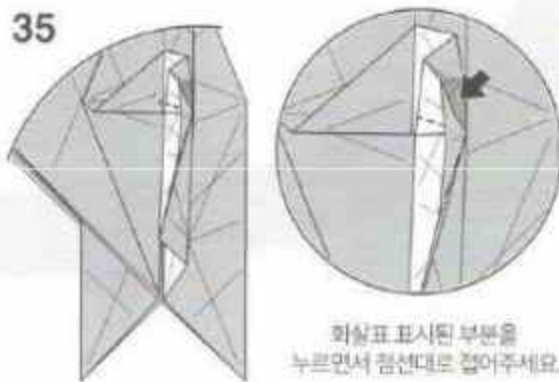

화살표 표시된 부분을
누르면서 점선대로 잡어주세요.

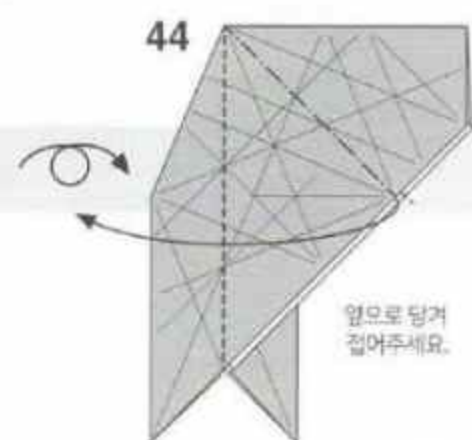

앞으로 당겨
접어주세요.

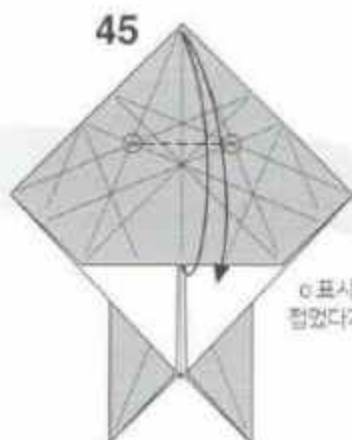

○ 표시를 기준으로
접었다가 펼쳐주세요.

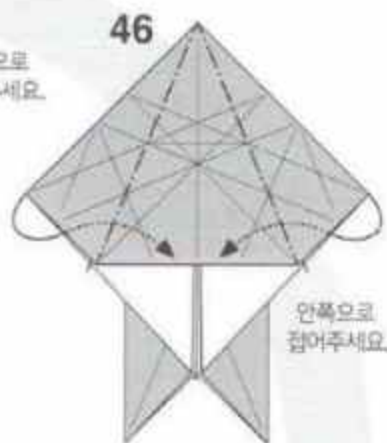

안쪽으로
접어주세요.

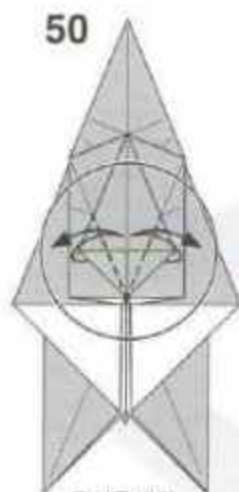

점선을 따라
접었다가 펼쳐주세요.

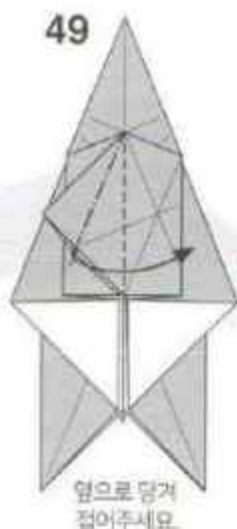

앞으로 당겨
접어주세요.

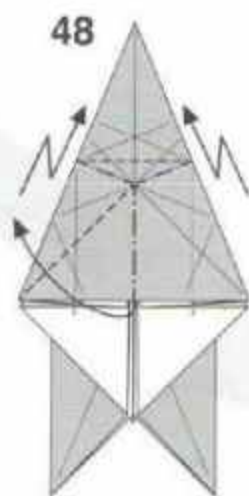

화살표를 따라 당기면서
계단접기 해주세요.

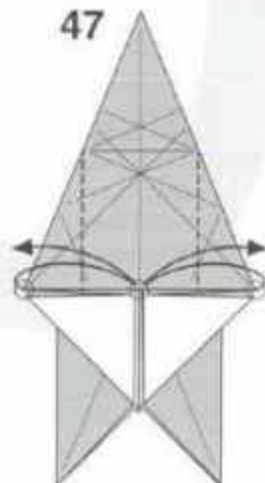

○ 표시를 기준으로
접었다가 펼쳐주세요.

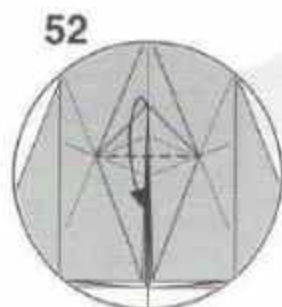

점선을 따라
아래로 접어주세요.

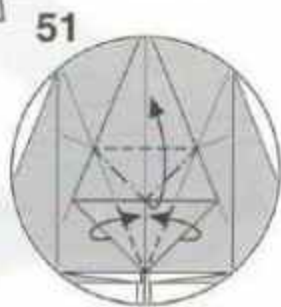

점선을 따라
위로 당겨 접어주세요.

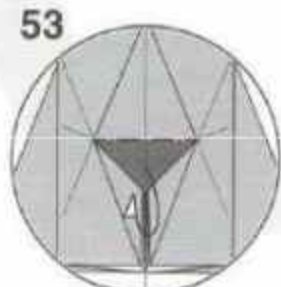

어두운 부분을
안쪽으로 접어 넣어주세요.

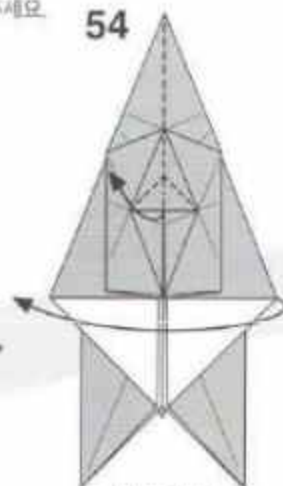

화살표를 따라
앞으로 접어주세요.



○ 표시를 기준으로
접었다가 펼쳐주세요.

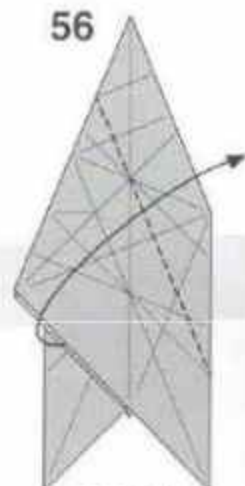

점선을 따라
잡어 올려주세요.

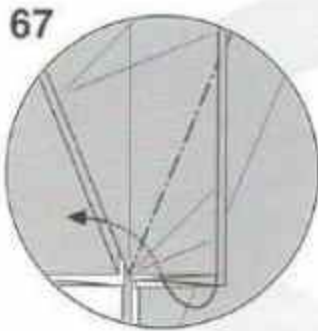

안쪽으로 접어주세요.

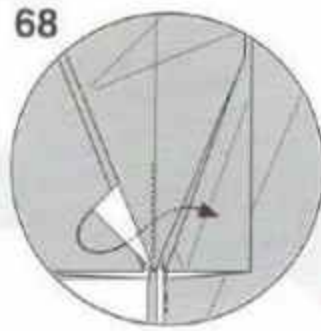

안쪽으로 접어주세요.

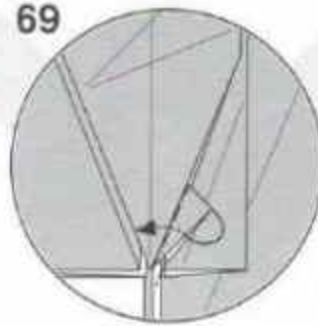

안쪽으로 접어주세요.

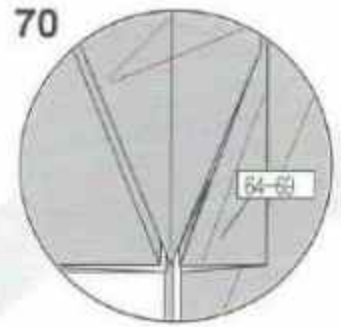

64-69를 반복해주세요.

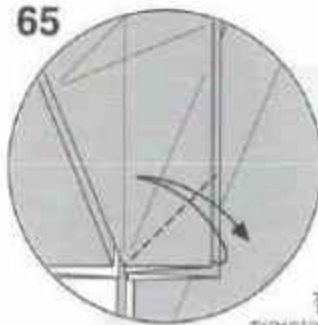

점선을 따라서
잡았다가 펼쳐주세요.

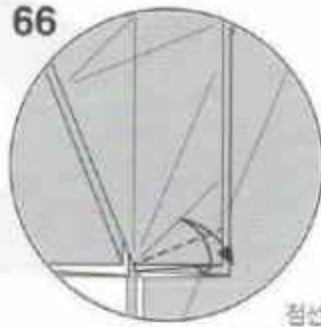

점선을 따라서
잡았다가 펼쳐주세요.

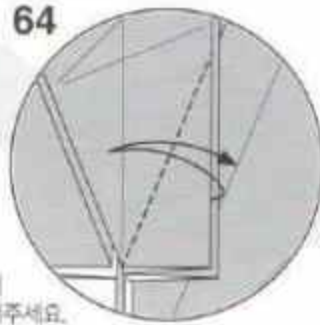

점선을 따라서
잡았다가 펼쳐주세요.



어두운 부분을
함몰시키기 해주세요.
(close sink)

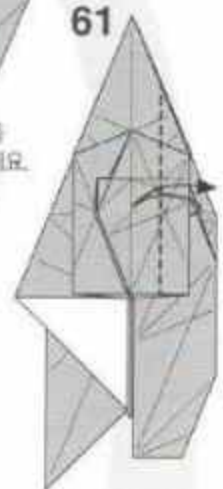

점선을 따라서
잡았다가 펼쳐주세요.



화살표를 따라서
옆으로 접어주세요.

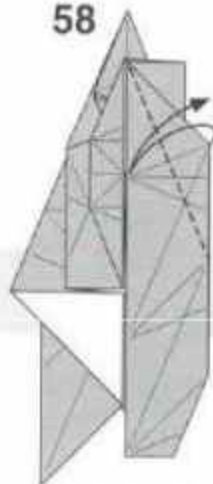

점선을 따라서
잡았다가 펼쳐주세요.

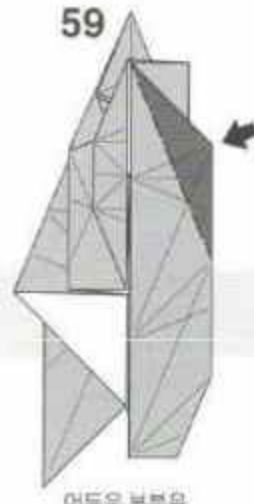

어두운 부분을
함몰시키기 해주세요.
(open sink)



화살표를 따라서
아래로 접어주세요.

71

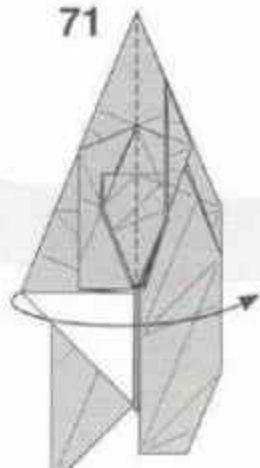

점선을 따라
앞으로 접어주세요.

72

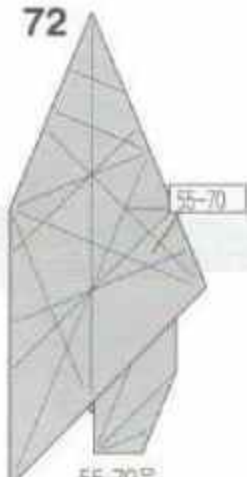

55-70을
반복해주세요.

73

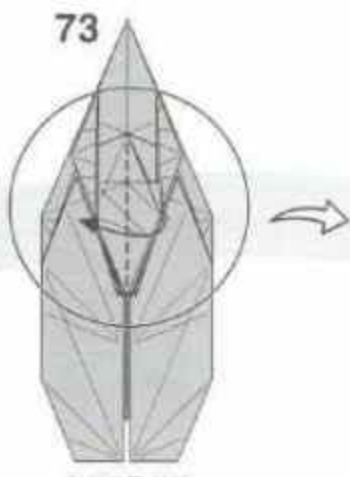

화살표를 따라
앞으로 접어주세요.

74

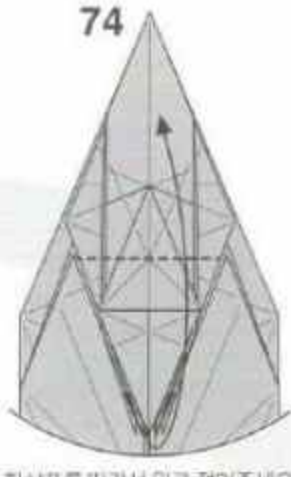

화살표를 따라서 위로 접어주세요.

77

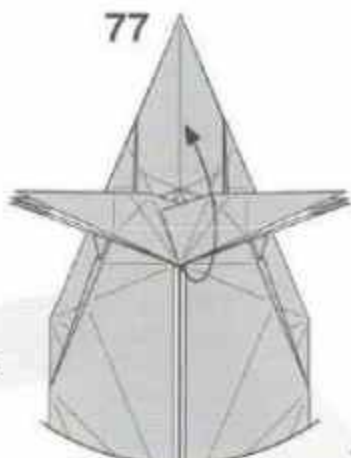

화살표를 따라
한 겹씩 접어붙여주세요.

75

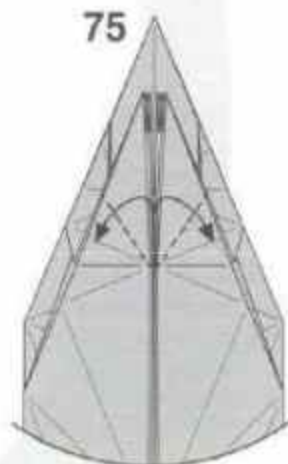

화살표를 따라
앞으로 접어주세요.

78

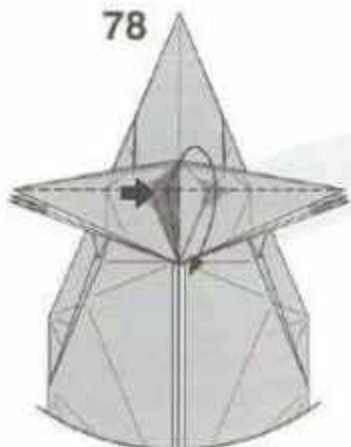

어두운 부분을
누르면서 접어주세요.

76

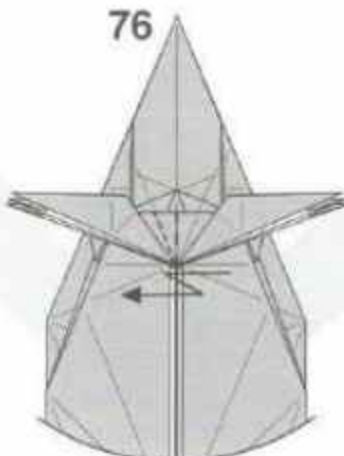

가운데로 종이를 모으면서
계단잡기 해주세요.

79



화살표를 따라
위로 접어주세요.

80

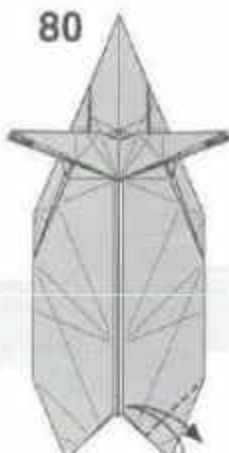

점선을 따라
접었다가 펼쳐주세요.

81



○ 표시를 기준으로
접었다가 펼쳐주세요.

82

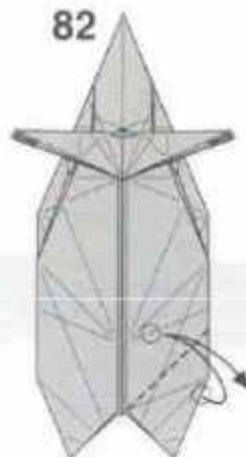

○ 표시를 기준으로
접었다가 펼쳐주세요.

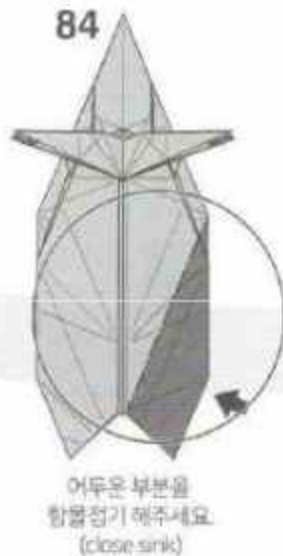
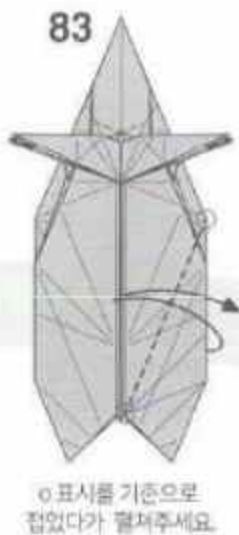
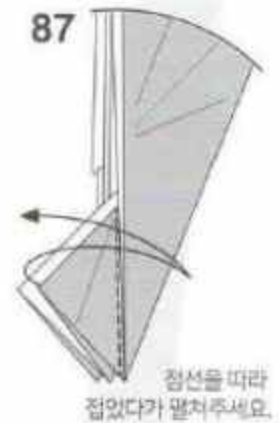
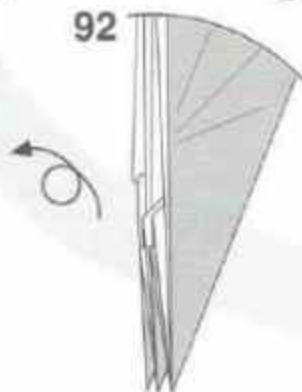
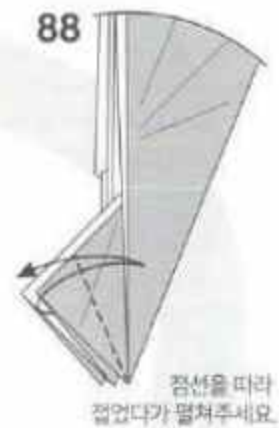
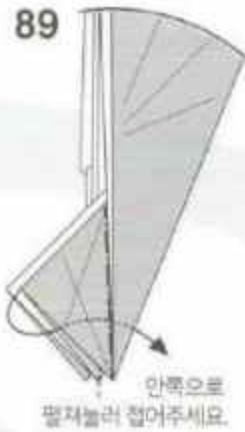
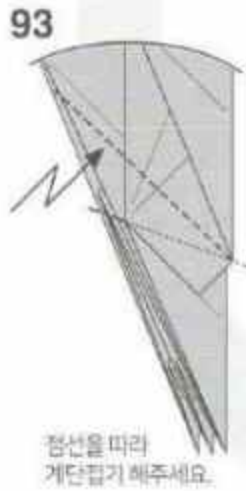
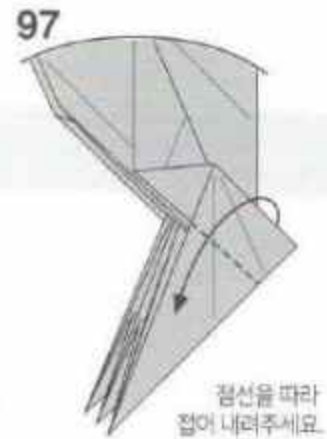
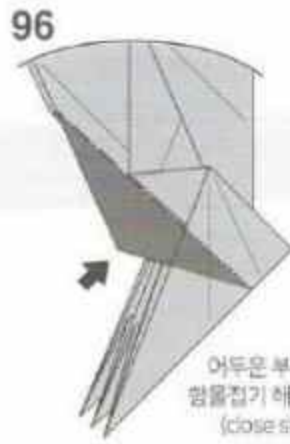
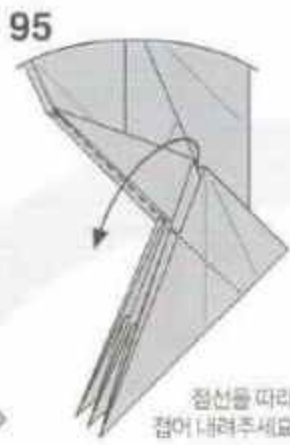
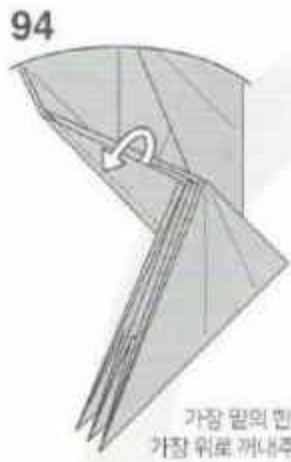

98

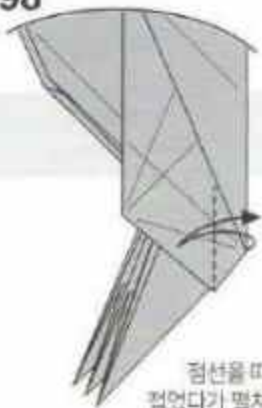

점선을 따라
접었다가 펼쳐주세요.

99

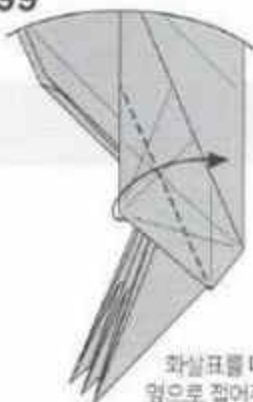

화살표를 따라
앞으로 접어주세요.

100

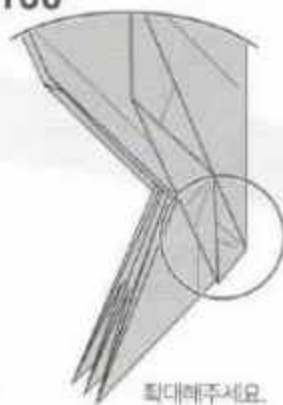

확대해주세요.



101

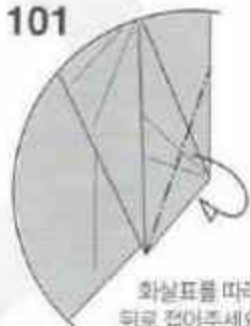

화살표를 따라
뒤로 접어주세요.

107

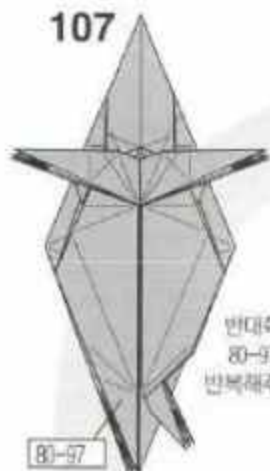

반대쪽도
80-97을
반복해주세요.

80-97

106



뒤집어주세요.

102

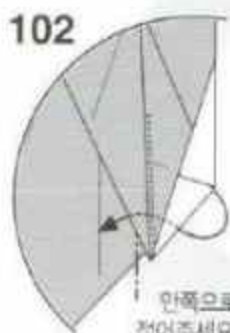

안쪽으로
접어주세요.

103



안쪽으로
접어주세요.

108

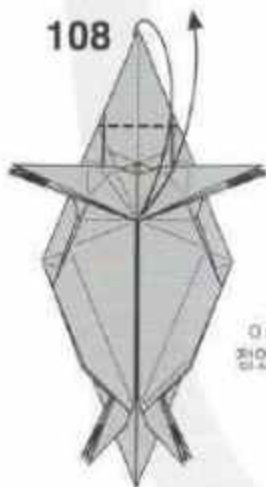

o 표시를 기준으로
접었다가 펼쳐주세요.



105



화살표를 따라
안쪽으로 접어주세요.

104

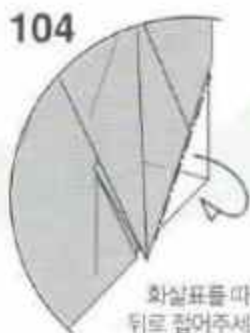

화살표를 따라
뒤로 접어주세요.

109

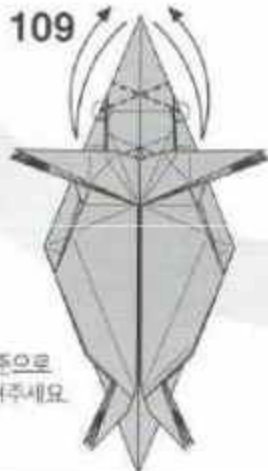

o 표시를 기준으로
접었다가 펼쳐주세요.

110

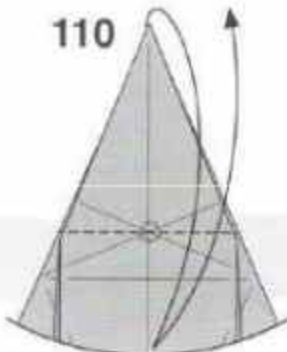

o 표시를 기준으로
접었다가 펼쳐주세요.

111

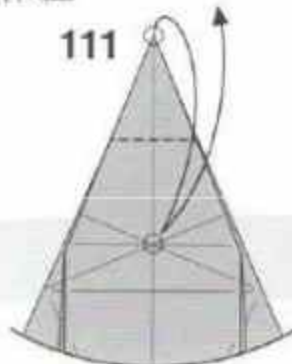

o 표시를 기준으로
접었다가 펼쳐주세요.

120

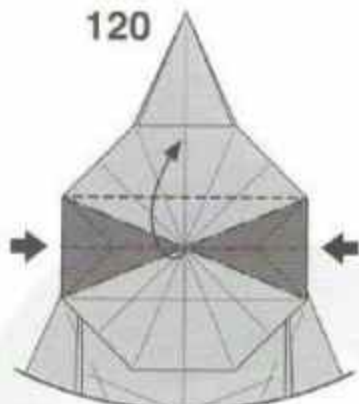

어두운 부분을 불러주면서
점심대로 접어주세요.

121

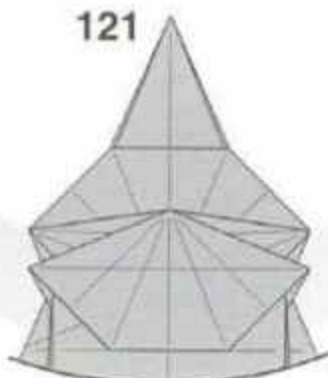

중간과정

122

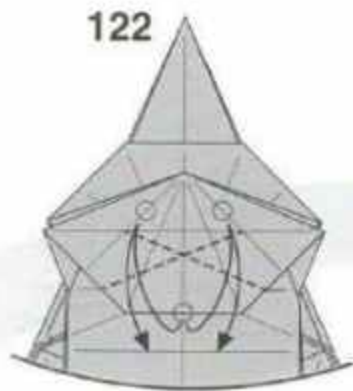

ㄱ 표시를 기준으로
접었다가 펼쳐주세요.

119

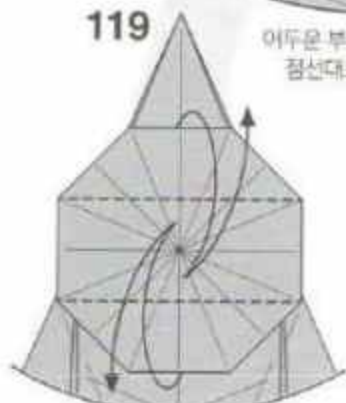

화살표를 따라
접었다가 펼쳐주세요.

116

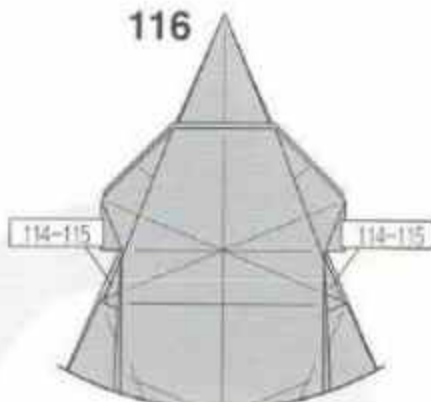

114-115를 반복해주세요.

117

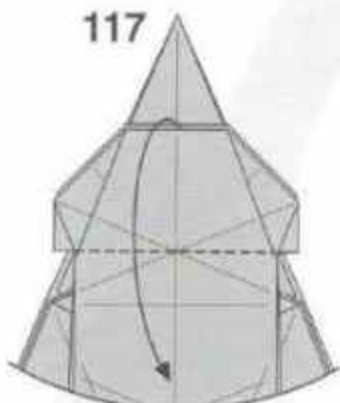

화살표를 따라
아래로 접어주세요.

118

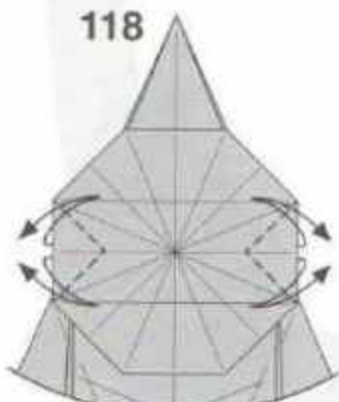

화살표를 따라
접었다가 펼쳐주세요.

115

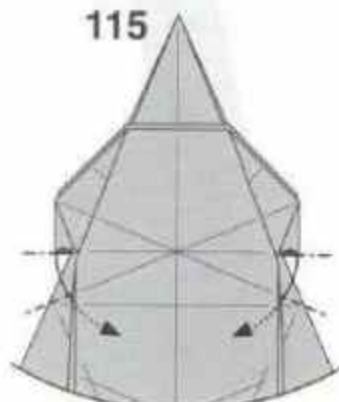

화살표를 따라
아래로 당겨주세요.

112

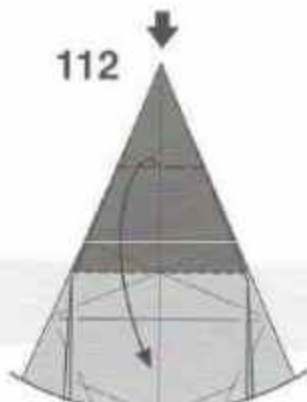

어두운 부분을 펼쳐 놓으세요.
(spread sink)

113

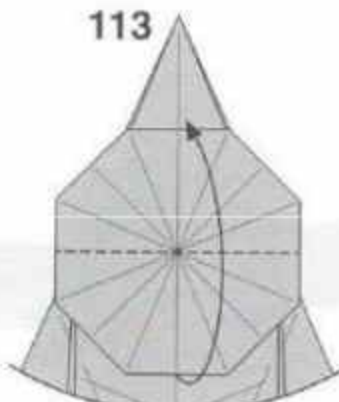

화살표를 따라 뒤로 접어주세요.

114

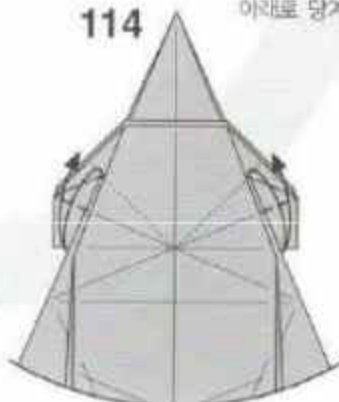

화살표를 따라 접었다가 펼쳐주세요.

123

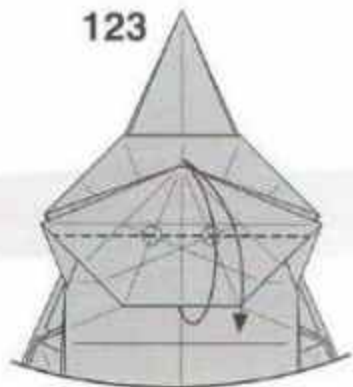

o 표시를 기준으로
접었다가 펼쳐주세요.

124

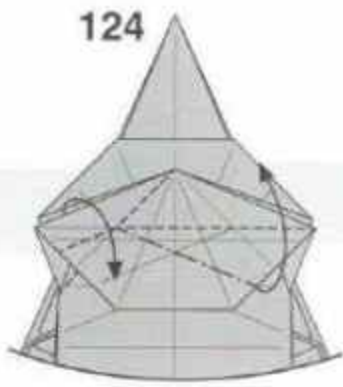

화살표를 따라 당겨주세요.

125

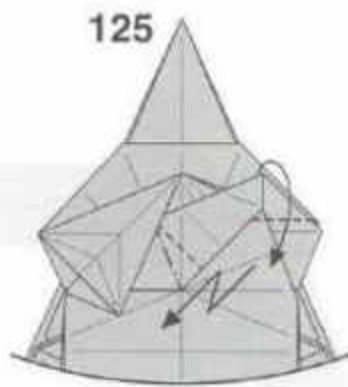

화살표를 따라 접어주세요.

130

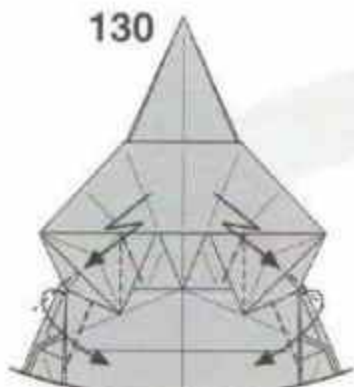

화살표를 따라 접어주세요.

129

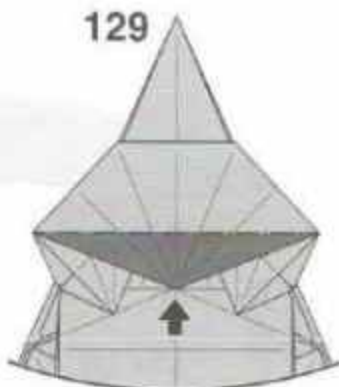

어두운 부분을
함몰시키기 해주세요.
(close sink)

126

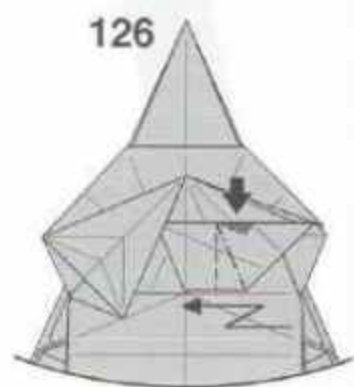

어두운 부분을 눌러주면서
편 상태로 접어주세요.

131

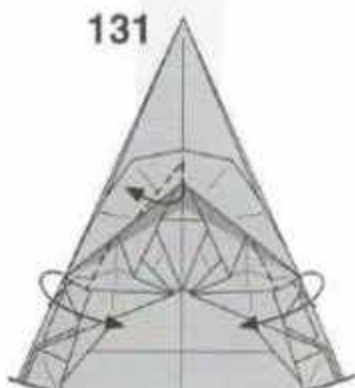

화살표를 따라 접어주세요.

128

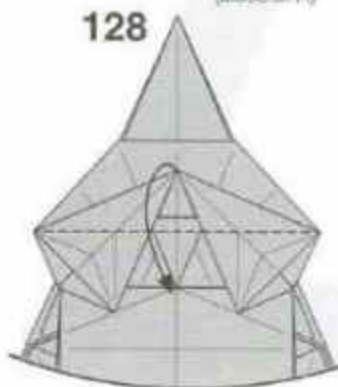

화살표를 따라
아래로 접어주세요.

127

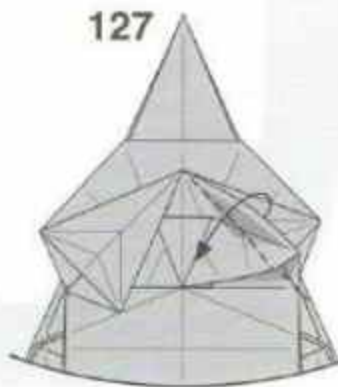

화살표를 따라
아래로 접어주세요.

132

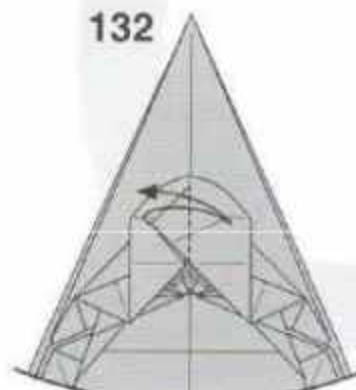

화살표를 따라
접었다가 펼쳐주세요.

133

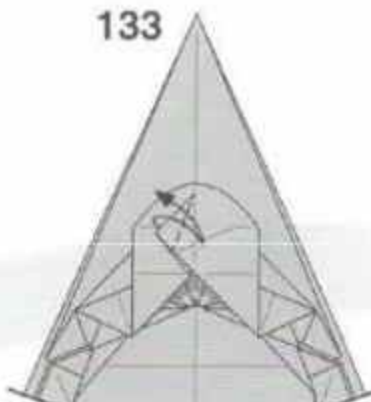

화살표를 따라
접었다가 펼쳐주세요.

134

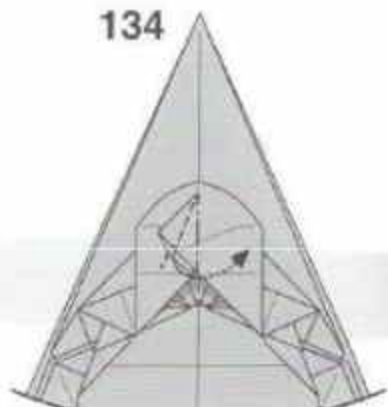

화살표를 따라
안쪽으로 당겨주세요.

144



위의 두 부분도
동일하게 꺼내주세요.

146

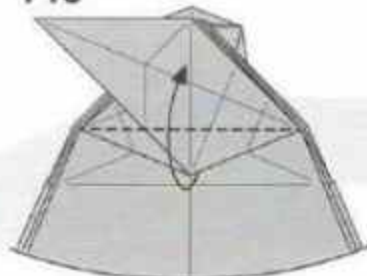

화살표를 따라서 위로 접어주세요.

145



반대쪽도 143-144를 반복해주세요.

143

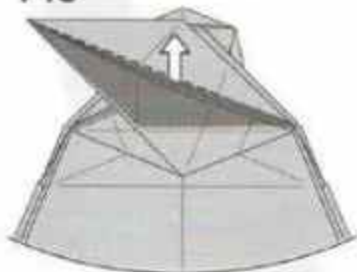

안쪽의 한 겹을 꺼내주세요.

139

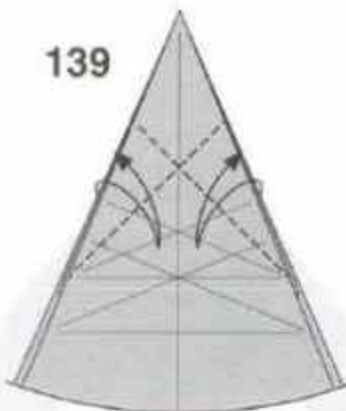

점선을 따라서
접었다가 펼쳐주세요.

142

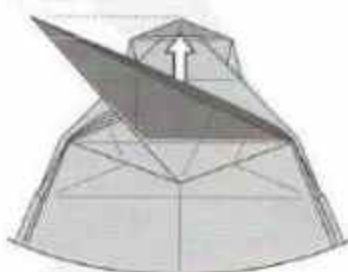

가장 안쪽의 한 겹을 꺼내주세요.

140

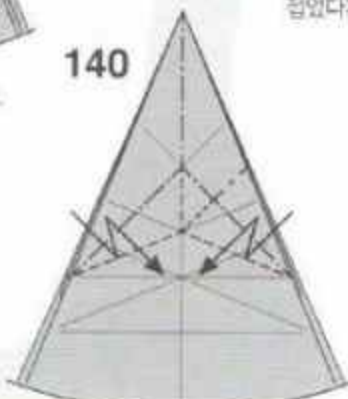

점선을 따라서 접어주세요.

138

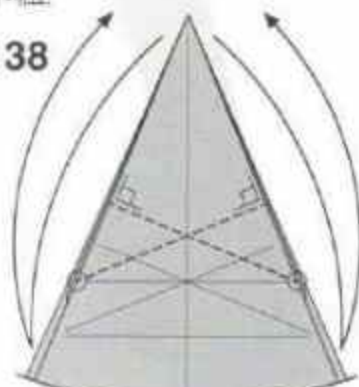

o 표시를 기준으로
접었다가 펼쳐주세요.

141



안쪽의 한 겹을 꺼내주세요.

135

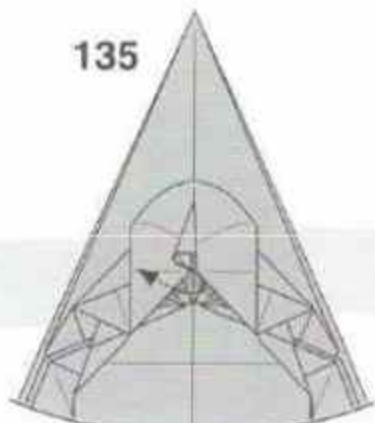

반대쪽도 134번처럼 안쪽으로 당겨주세요.

136

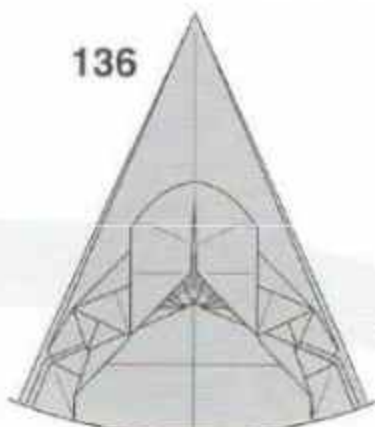

뒤집어주세요.

137

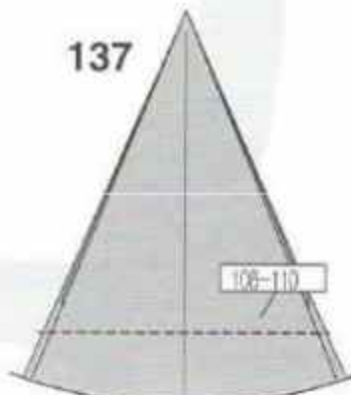

108-110을 반복해주세요.

147



어두운 부분을 함몰집기 해주세요.
(close sink)

148

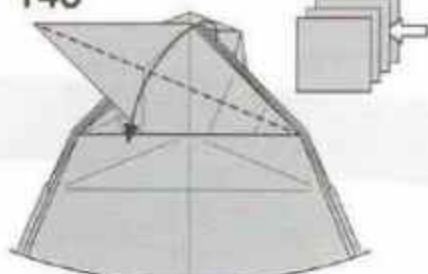

세 겹을 아래로 접어주세요.

149

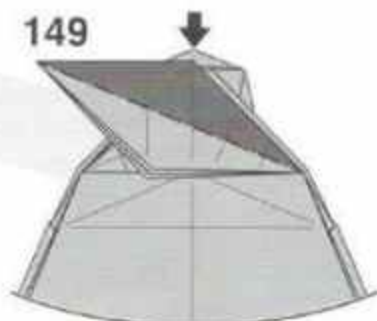

어두운 부분을 함몰집기 해주세요.

153



화살표를 따라
뒤로 접어주세요.

150

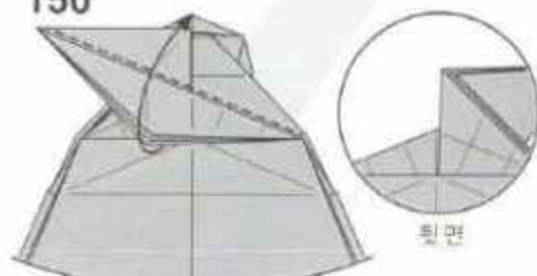

세 겹을 위로 접어주세요.

154

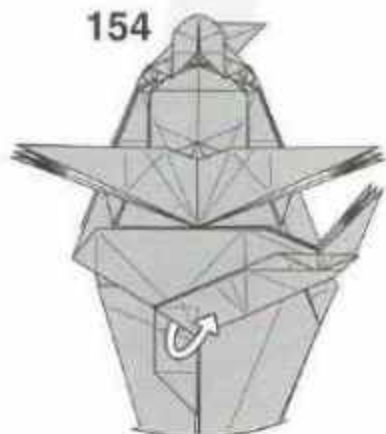

아래쪽의 한 겹을
맨 위로 꺼내주세요.

152

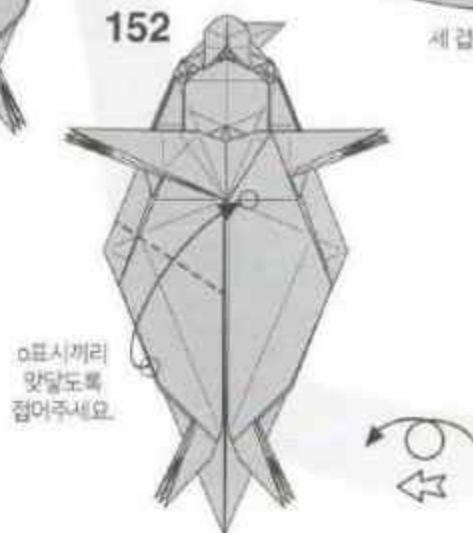

표시끼리
맞닿도록
접어주세요.

151



뒤집어주세요.

155

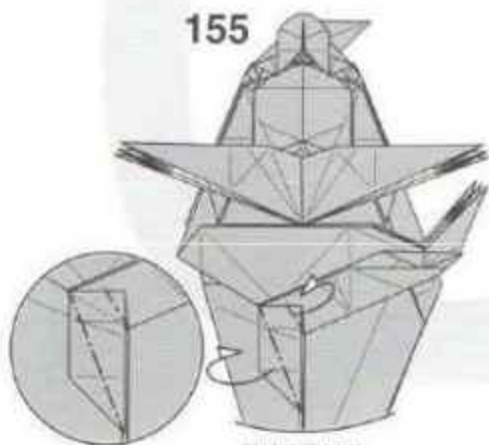

화살표를 따라
뒤로 접어주세요.

156

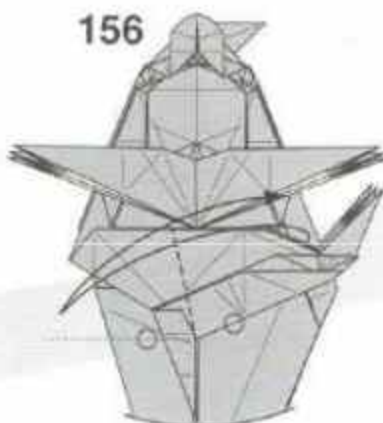

표시끼리 맞닿도록
접었다가 펼쳐주세요.

157

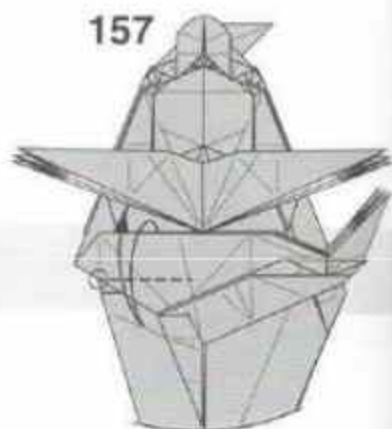

표시를 기준으로
접었다가 펼쳐주세요.

166

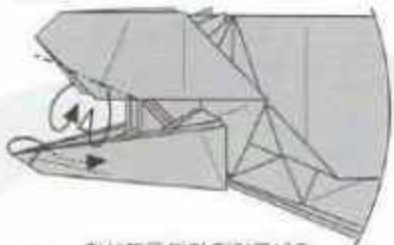

화살표를 따라 접어주세요.

167

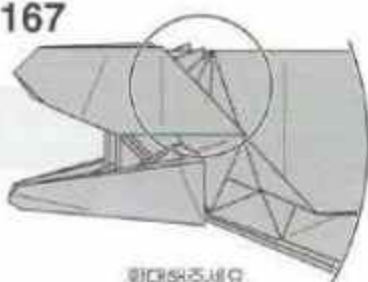

확대해주세요.



165

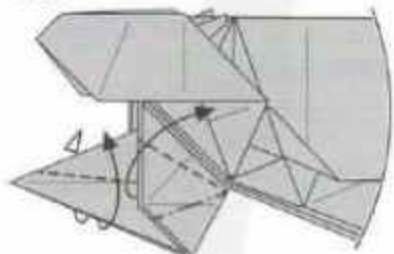

화살표를 따라 접어주세요.

162

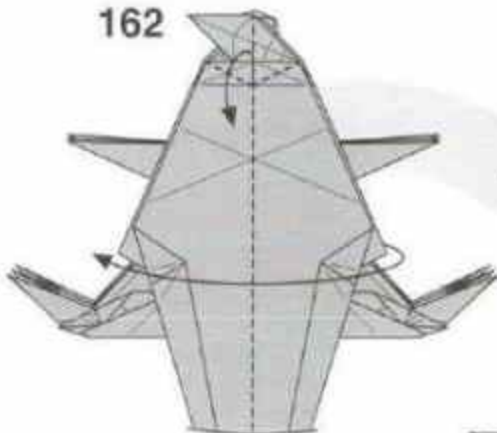

화살표를 따라 접어주세요.

164

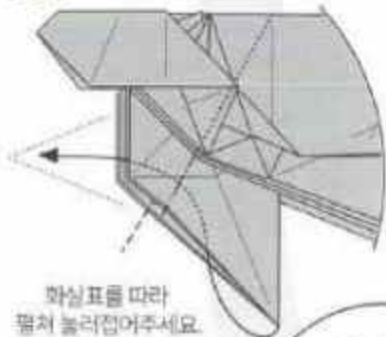

화살표를 따라 펼쳐 놓아주세요.

161

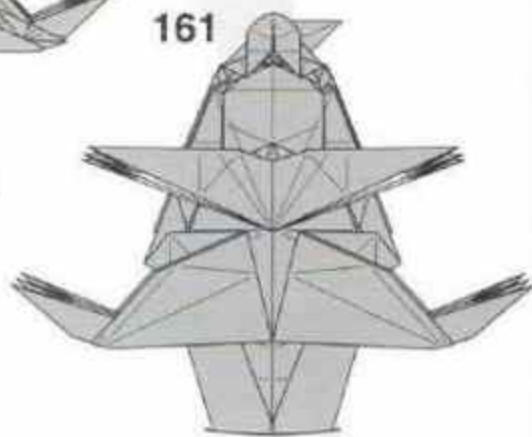

뒤집어주세요.

163

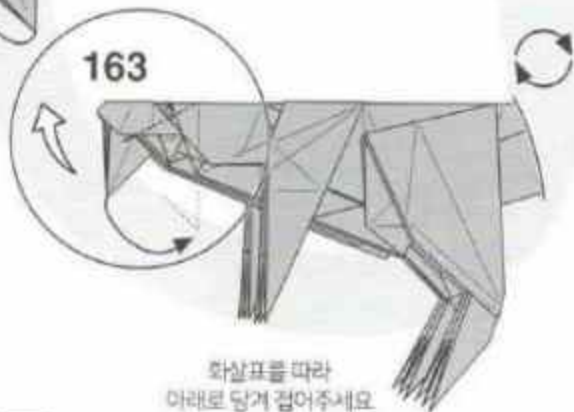

화살표를 따라 아래로 당겨 접어주세요.

160

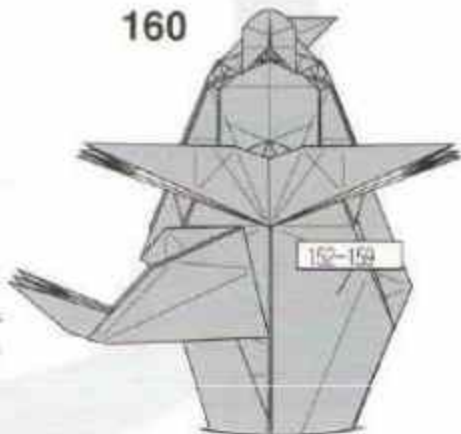

152-159를 반복해주세요.

158

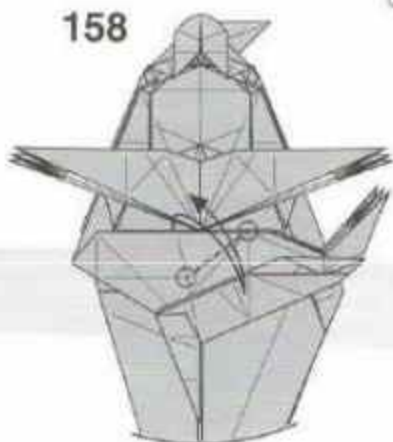

표시를 기준으로 접었다가 펼쳐주세요.

159

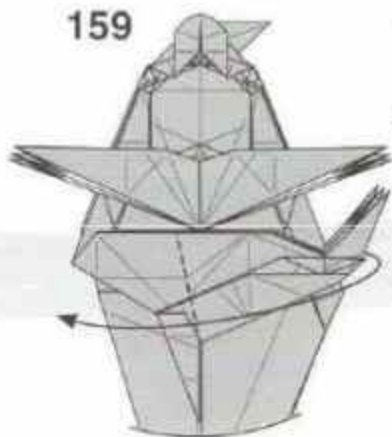

화살표를 따라서 접어주세요.

168

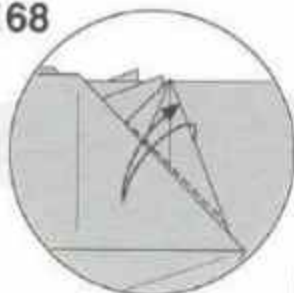

점선을 따라서
접었다가 펼쳐주세요.

169

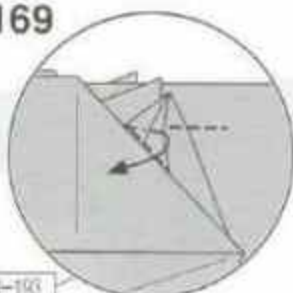

180-193

화살표를 따라
아래로 밀어 넣어주세요.

170

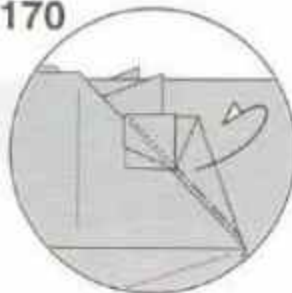

화살표를 따라
뒤로 접어주세요.

171



반대쪽도
168-170을 반복해주세요.

176

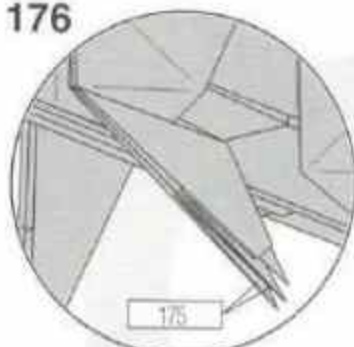

175

나머지 두 가지도 175번 과정을 반복해주세요.

175

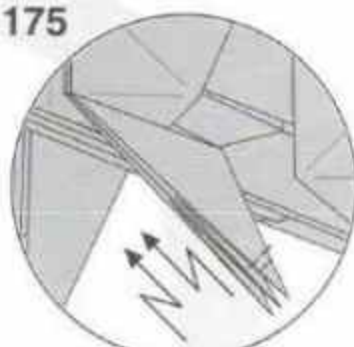

양쪽으로 계단질기해주세요.

172

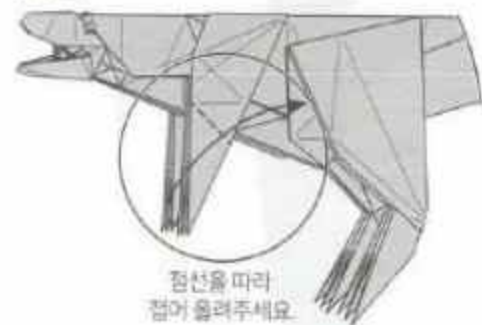

점선을 따라
접어 올려주세요.

177

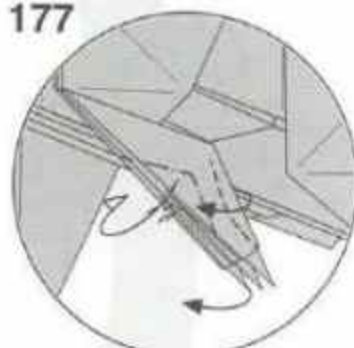

점선대로 접어서 다듬어주세요.

174

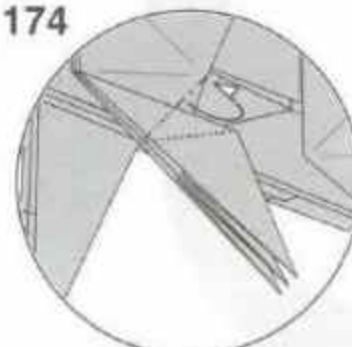

점선을 따라 뒤로 접어주세요.

173

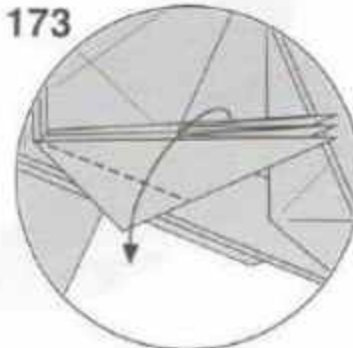

점선을 따라 접어주세요.

178

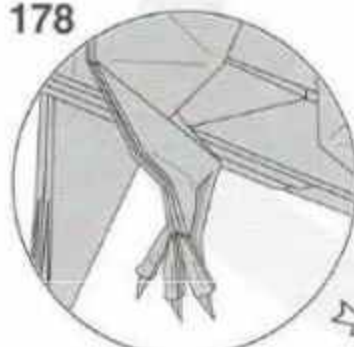

반대쪽도
172-177을 반복해주세요.

179



화살표를 따라
안쪽으로 접어주세요.

180



점선을 따라서
접었다가 펼쳐주세요.

192

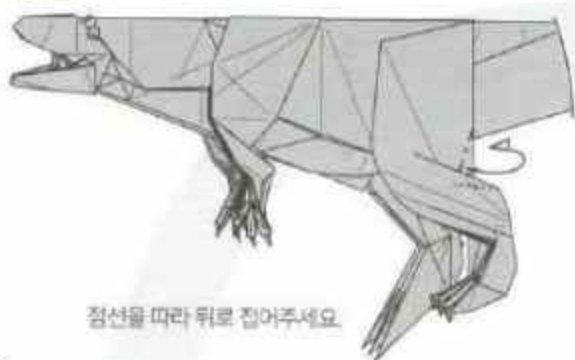

점선을 따라 뒤로 접어주세요.

193

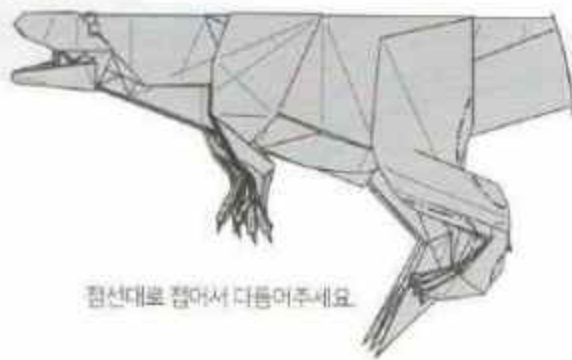

점선대를 접어서 다듬어주세요.

191

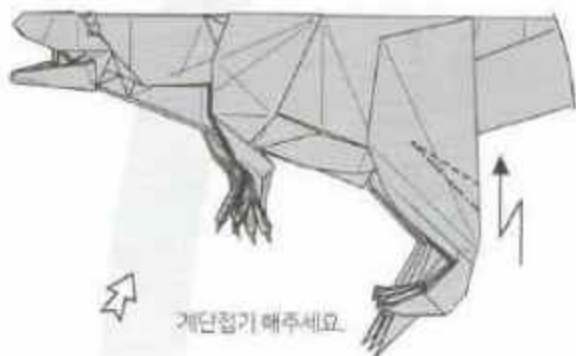

계단접기 해주세요.

187



화살표를 따라 펼쳐 눌러 접어주세요.

186



화살표를 따라 아래로 밀어 접어주세요.

190



189



화살표를 따라 아래로 밀어 접어주세요.

188

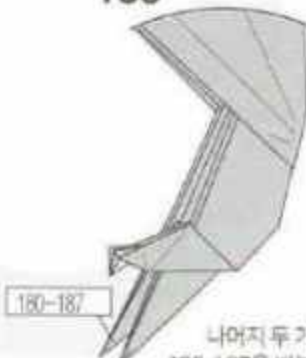

나머지 두 가지도 180-187을 반복해주세요.

185

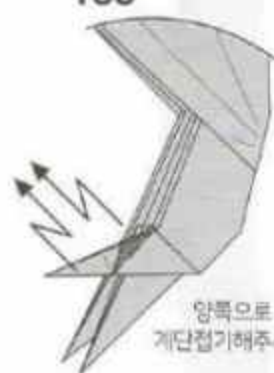

양쪽으로 계단접기 해주세요.

181



점선을 따라서 접었다가 펼쳐주세요.

182

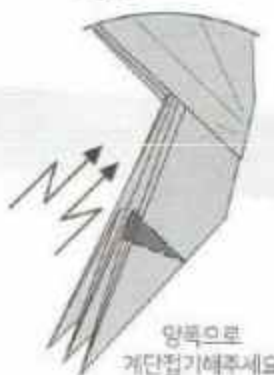

양쪽으로 계단접기 해주세요.

183

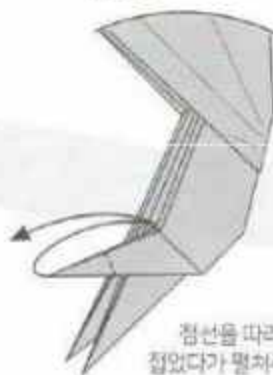

점선을 따라서 접었다가 펼쳐주세요.

184

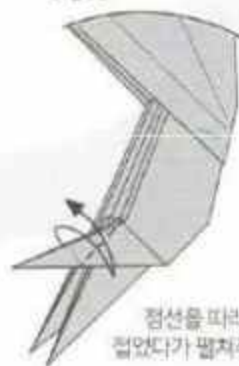

점선을 따라서 접었다가 펼쳐주세요.

194

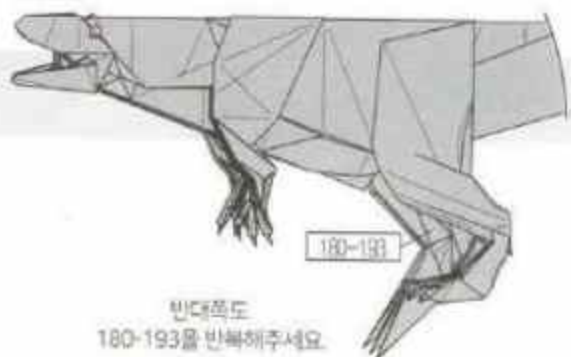

195

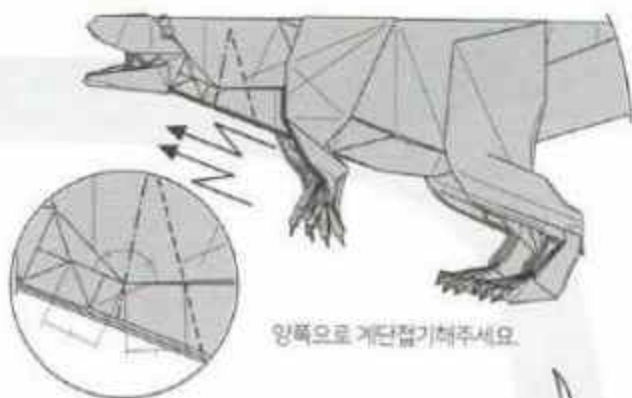

198

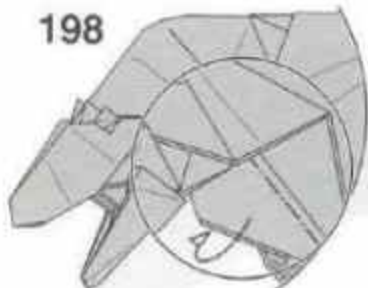

197



196



199

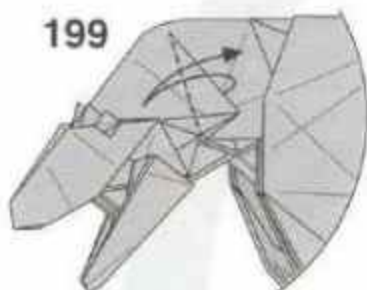

203



200

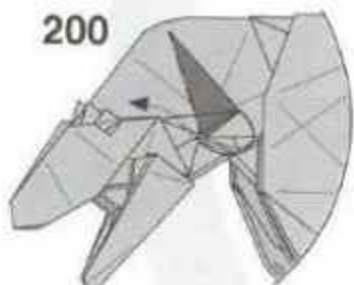

202

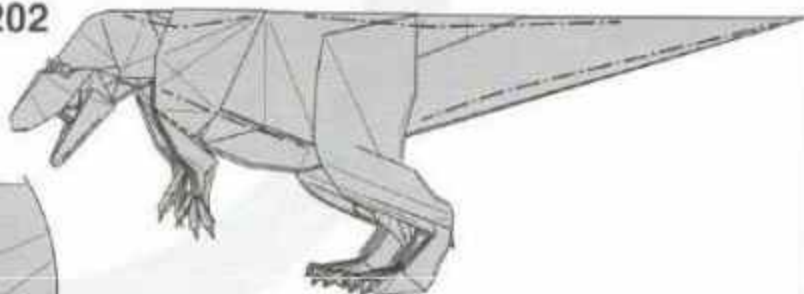

201

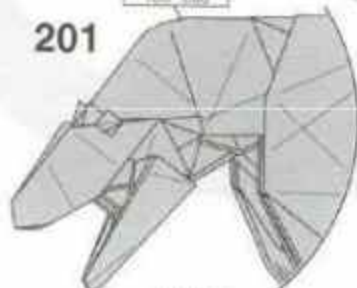

반대쪽도
196-200을 반복해주세요.

작품 전개도

CREASE PATTEN

나방파리

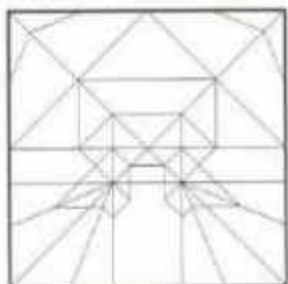

나비

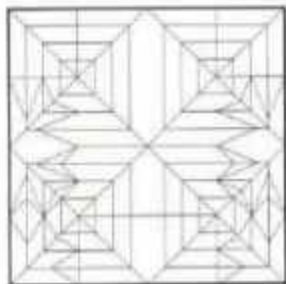

소드

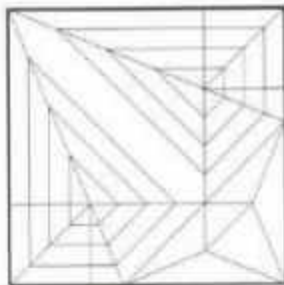

침묵



마이코

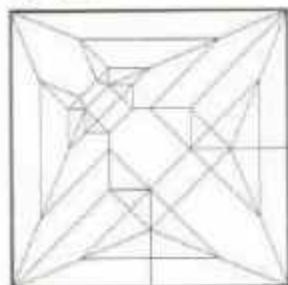

아이스크림

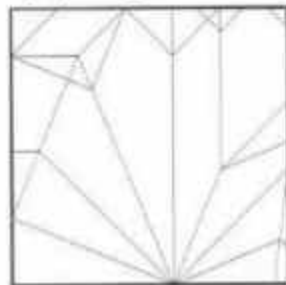

수박조각

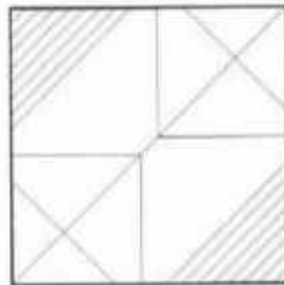

버니

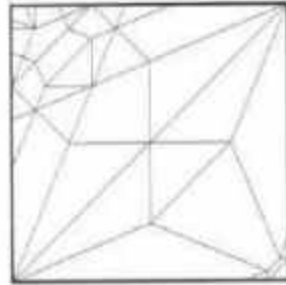

토끼

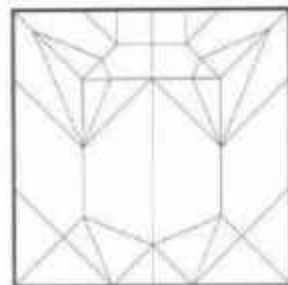

피라루크



빨간통뚝

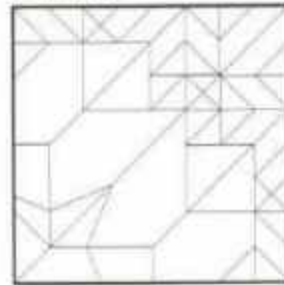

아프간하운드

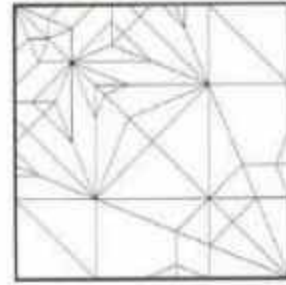

디모르포돈

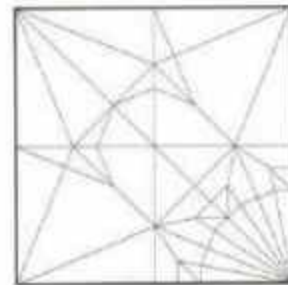

다이노소어

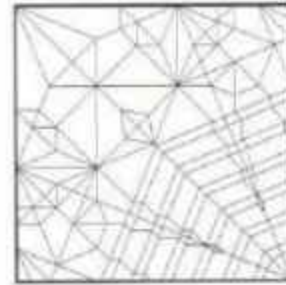

태드레곤

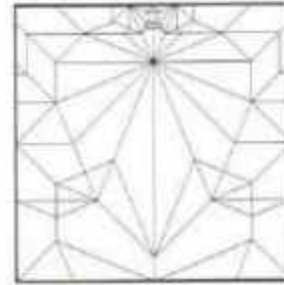

흑동고래

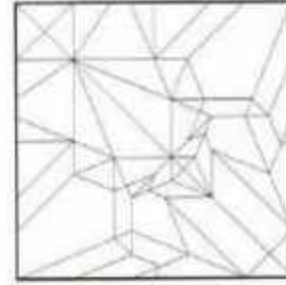

포크레인 2

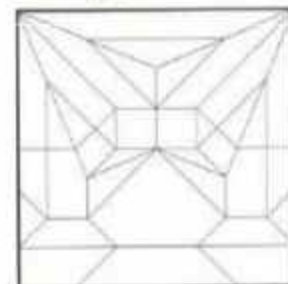

맹꽁이

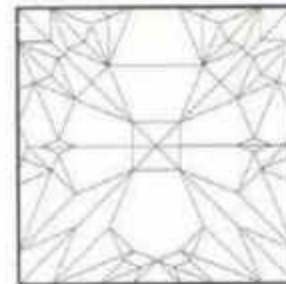

청설모

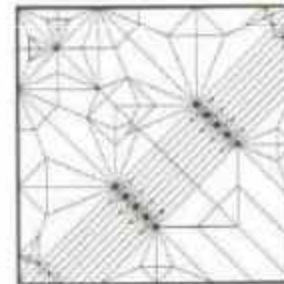

알로사우루스

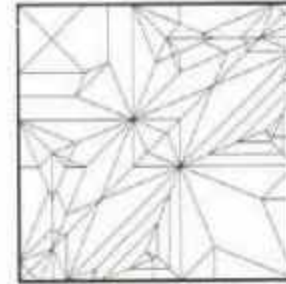

종이접기 매니아를 위한

종이접기 스킬업

ORIGAMI SKILL UP
ADVANCED LEVEL

초판1쇄 인쇄 | 2021년 01월 11일
초판1쇄 발행 | 2021년 01월 18일

참여 작가 | 김진우, 박중우, 장용익, 이인섭, 유태용, 맹형규, 정재일, 한지우
기획/편집/감수 | 김진우, 장용익
진행 | 이승은, 이경구
도면 디자인 | 장용익, 이인섭, 유태용, 맹형규, 정재일, 박중우
표지 디자인 | 장용익

발행인 | 오경해
펴낸곳 | (사) 한국종이접기협회
주소 | 서울시 중구 다산로64 (신당동 366-104)
전화 | 02 - 2254 - 4561
팩스 | 02 - 2254 - 4565
홈페이지 | www.origami.or.kr
등록번호 | 제6-0112호

- 이 책은 저작권법에 따라 보호받는 저작물이므로 무단 전재와 복제를 금합니다.
- 이 책 내용의 전부 또는 일부를 이용하려면 반드시 저작권자와 (사)한국종이접기협회의 서면 동의를 받아야 합니다.
- (사) 한국종이접기협회에서 출간되는 [종이접기 스킬업]의 판매 수익금은 창작 종이접기 작가 육성을 위해 사용됩니다.

종이접기 매니아를 위한

ORIGAMI PRO



동물 종이접기편
정가: 12,000원



판타지 종이접기편
정가: 15,000원



기계 종이접기편
정가: 15,000원



바다생물 종이접기편
정가: 20,000원



고대생물 종이접기편
정가: 22,000원



(사)한국종이접기협회에서 만든
종이접기 전문가용 한지
단청지 / 색한지 / 순백지

구입문의

- 유명종이 : 02-2233-4563
- 알라딘 : www.aladin.co.kr

값 22,000원



13630

9 788997 772377

ISBN 978-89-97772-37-7



ORIGAMI SKILL UP

ADVANCED LEVEL



종이접기 실력향상을 위한

ADVANCED LEVEL 20작품수록



대한민국
한국종이접기협회
KOREA ORIGAMI ASSOCIATION