

CarToon Origami 3

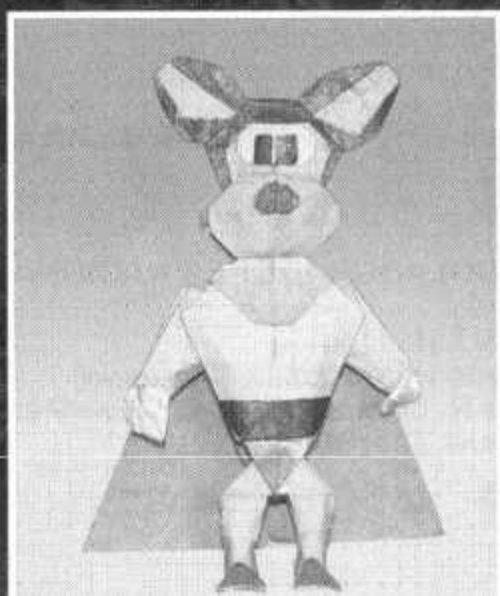

By Halle

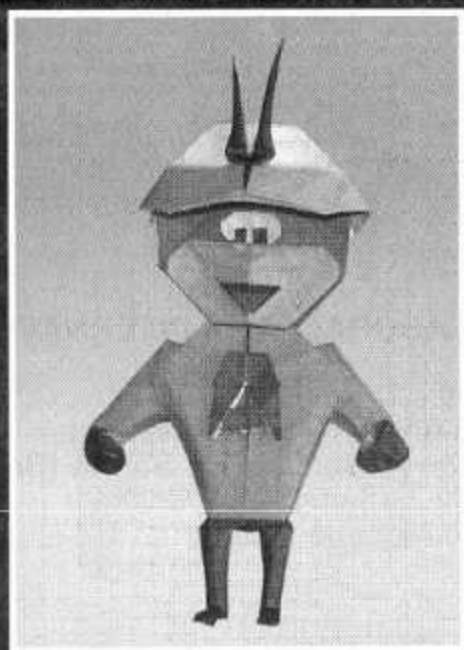

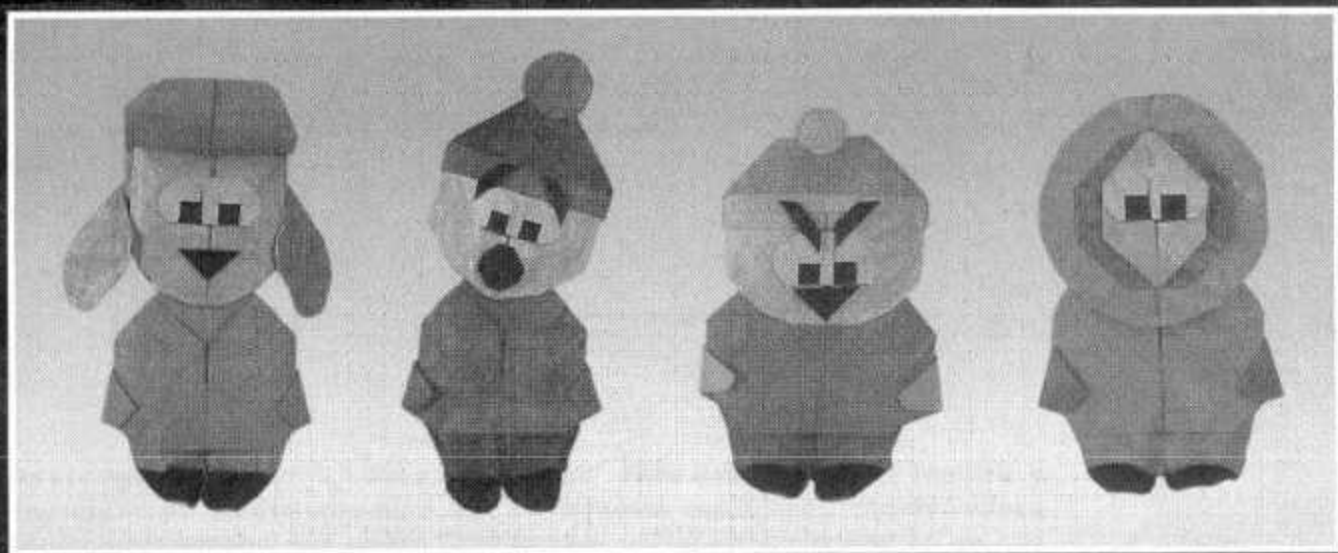
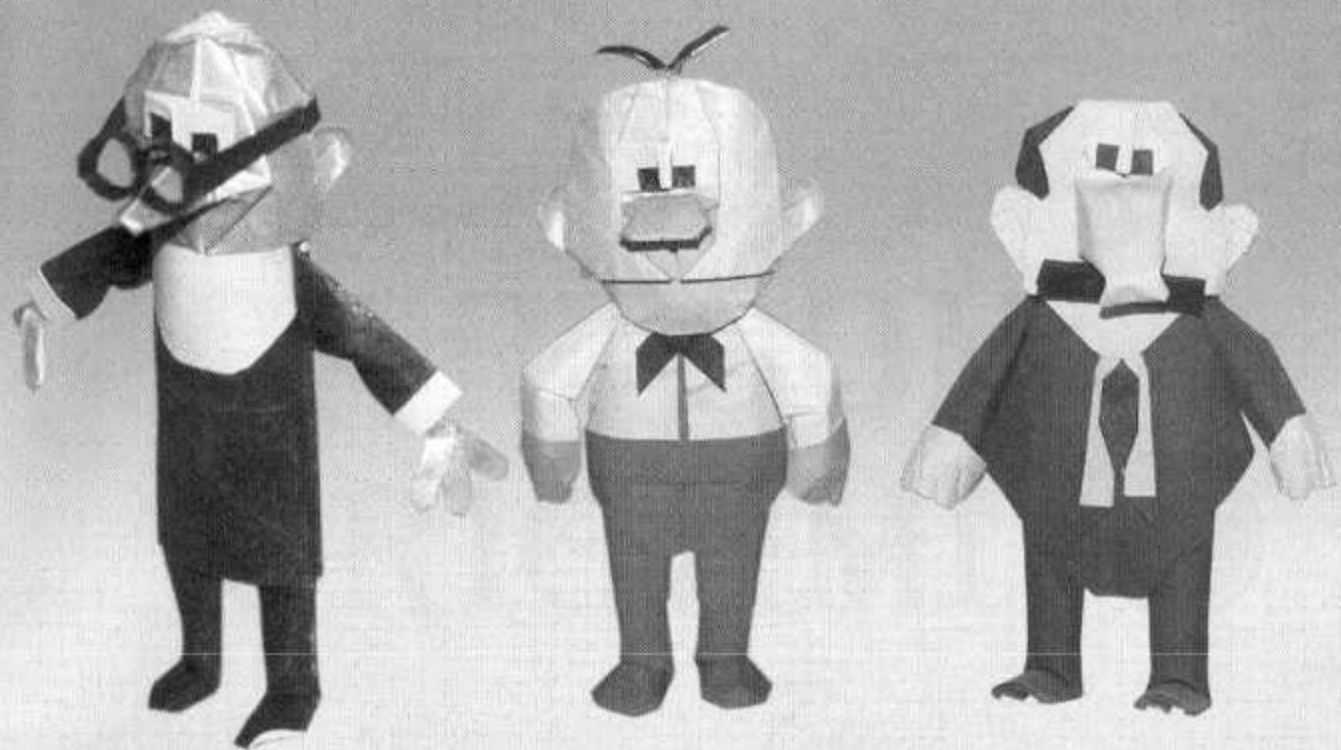

Autor
Fecha de edición
Edición
Modelos diagramados por
Recortados de fotografías

Halle
Noviembre 2002
700 ejemplares
J.A.V.I.
Alfredo Pérez

Tablas realizadas por **Alfredo Pérez Jiménez**

COLABORADORES NACIONALES

J.A.V.I. (Madrid)
Alfredo Pérez Jiménez (Madrid)
José R. Quintana Delgado (Las Palmas)
Manuel Sirgo Alvarez (León)

COLABORADORES INTERNACIONALES

Nicolas Terry (Francia)
Shai Aharon (Nueva Zelanda)
Thiago Alexandre Dos Santos (Brasil)
Penny Groom (Reino Unido)
Dario Motterle (Italia)

ÍNDICE



PÁGINA 12



PÁGINA 22

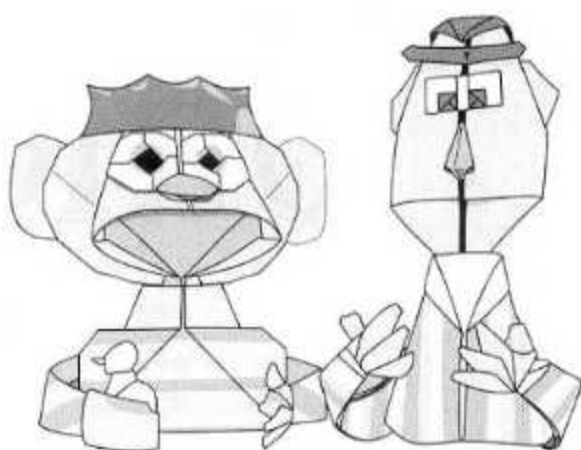

PÁGINA 29

PÁGINA 38

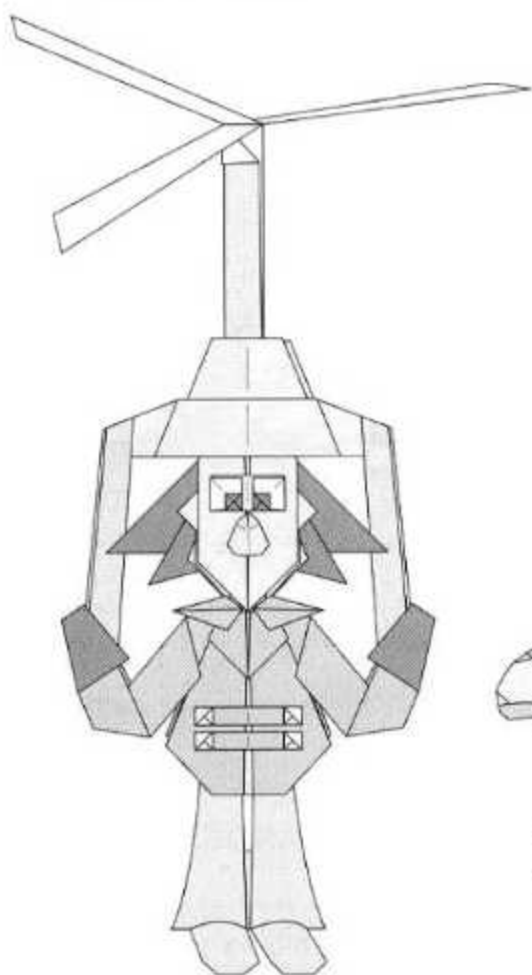

PÁGINA 45

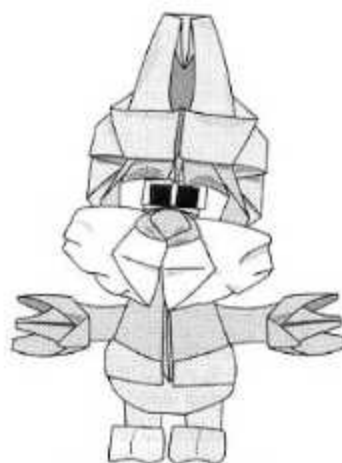

PÁGINA 56

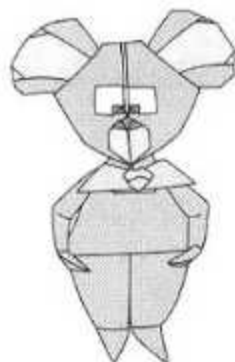

PÁGINA 65

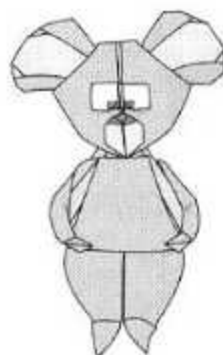

PÁGINA 73

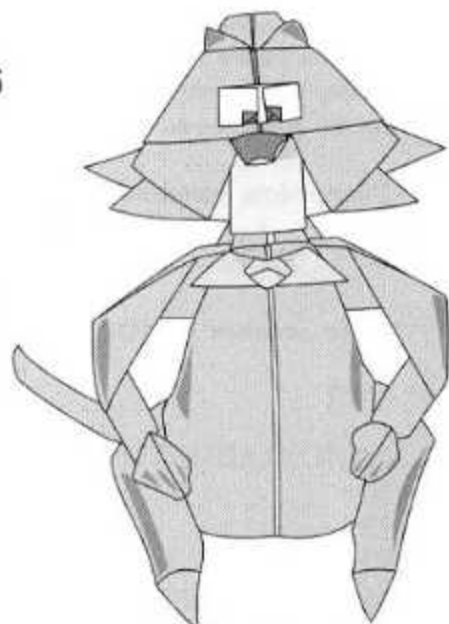

PÁGINA 81

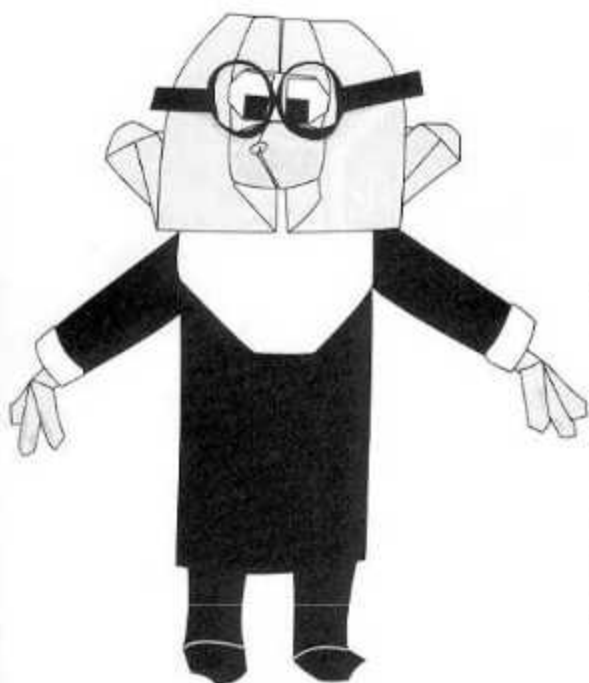

PÁGINA 90

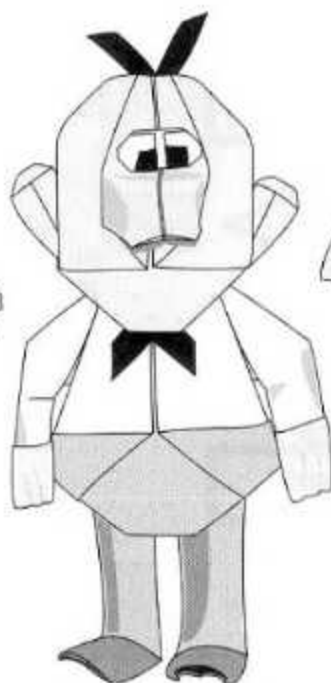

PÁGINA 96

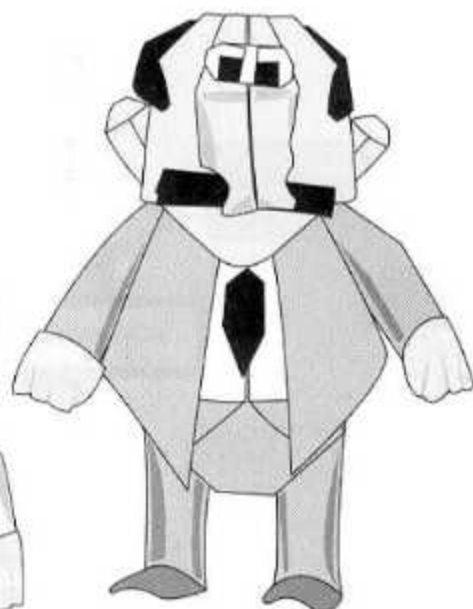

PÁGINA 104



PÁGINA 113

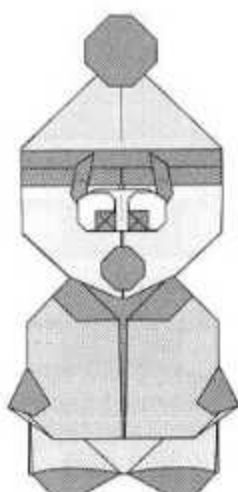

PÁGINA 118

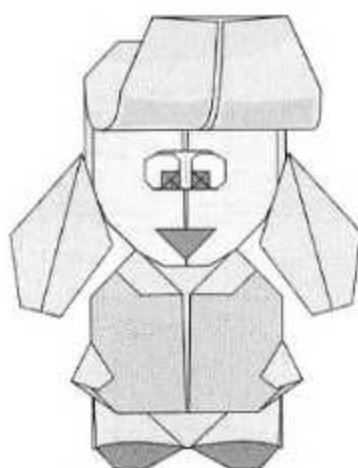

PÁGINA 123

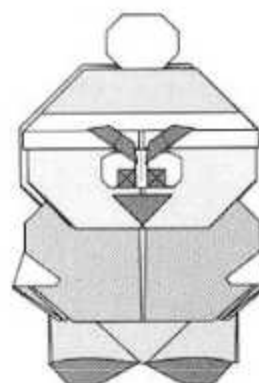

PÁGINA 129

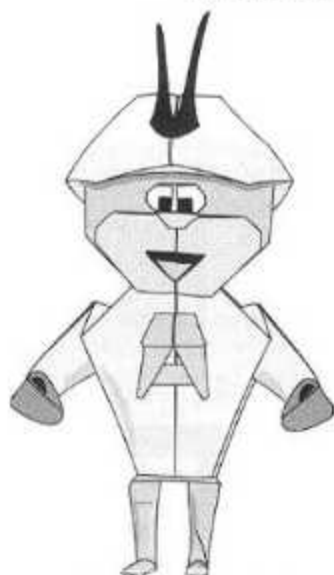

PÁGINA 134

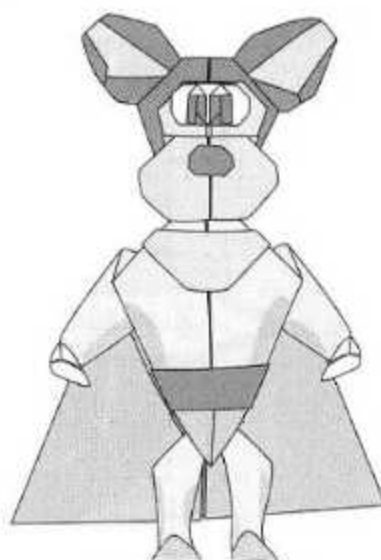

PÁGINA 141

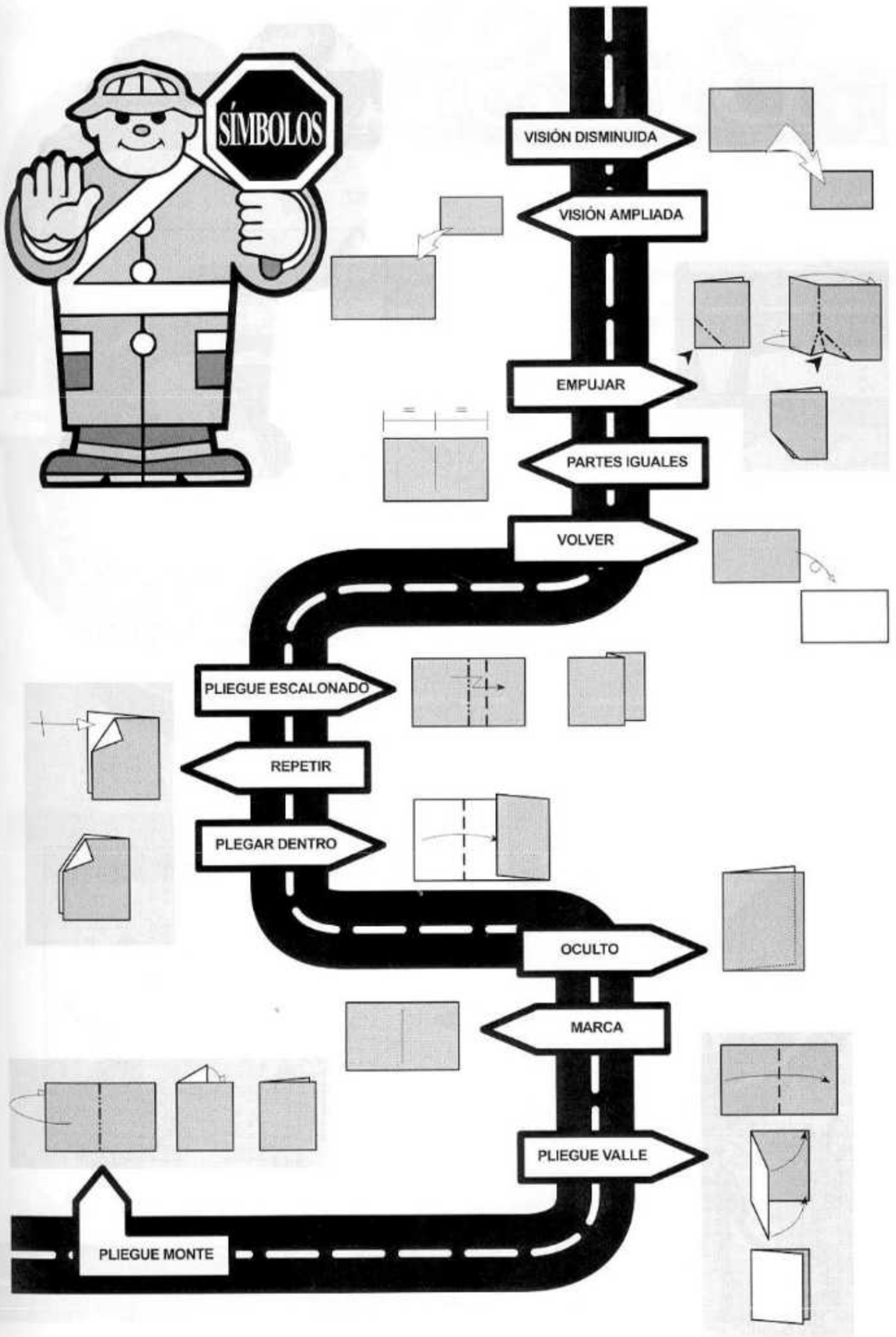

BASES

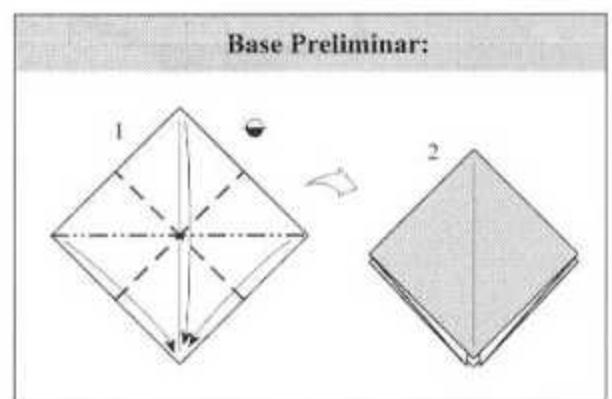
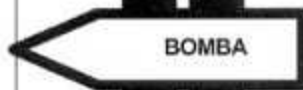
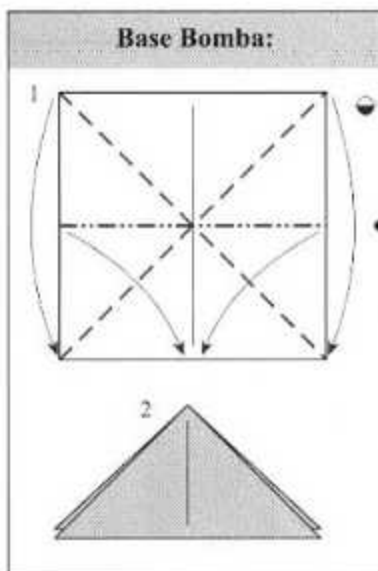
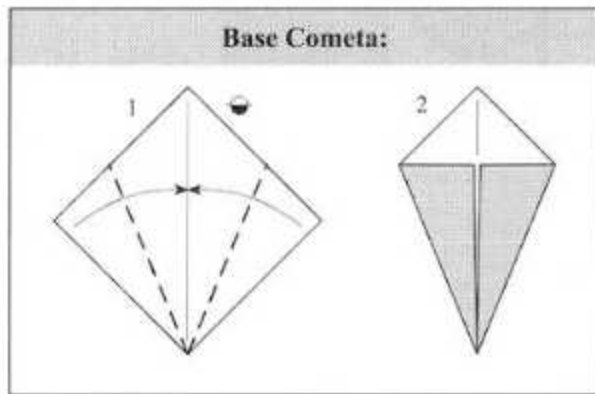

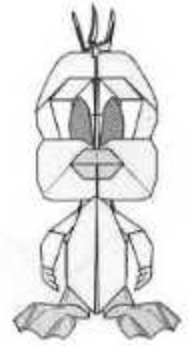
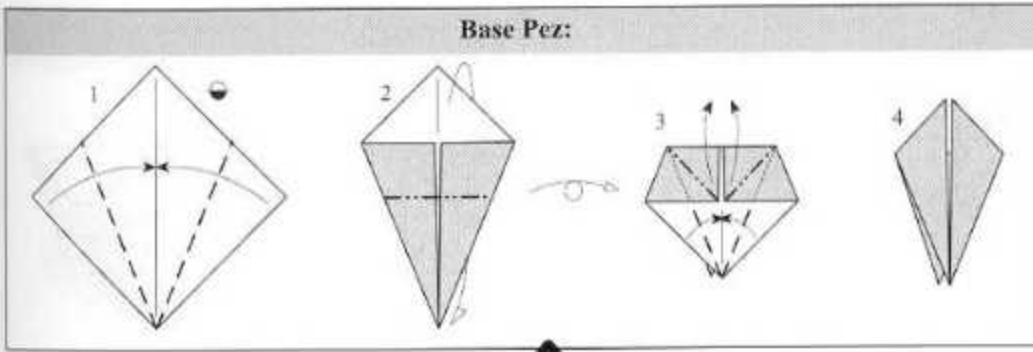

PEZ

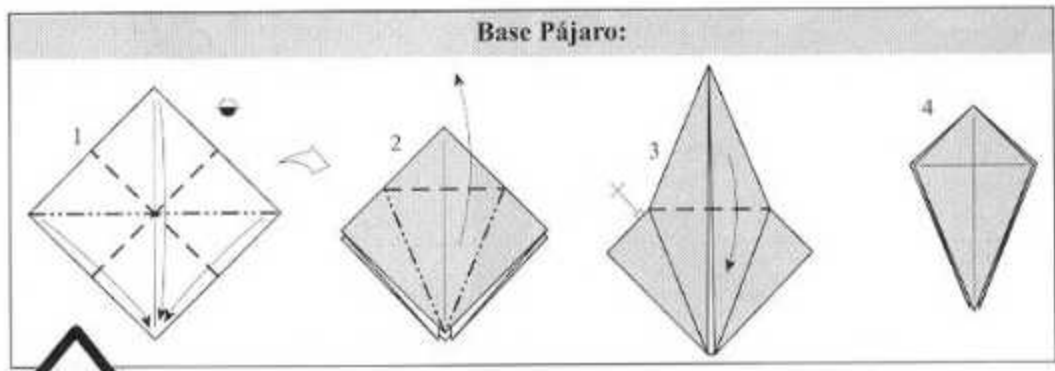

PÁJARO

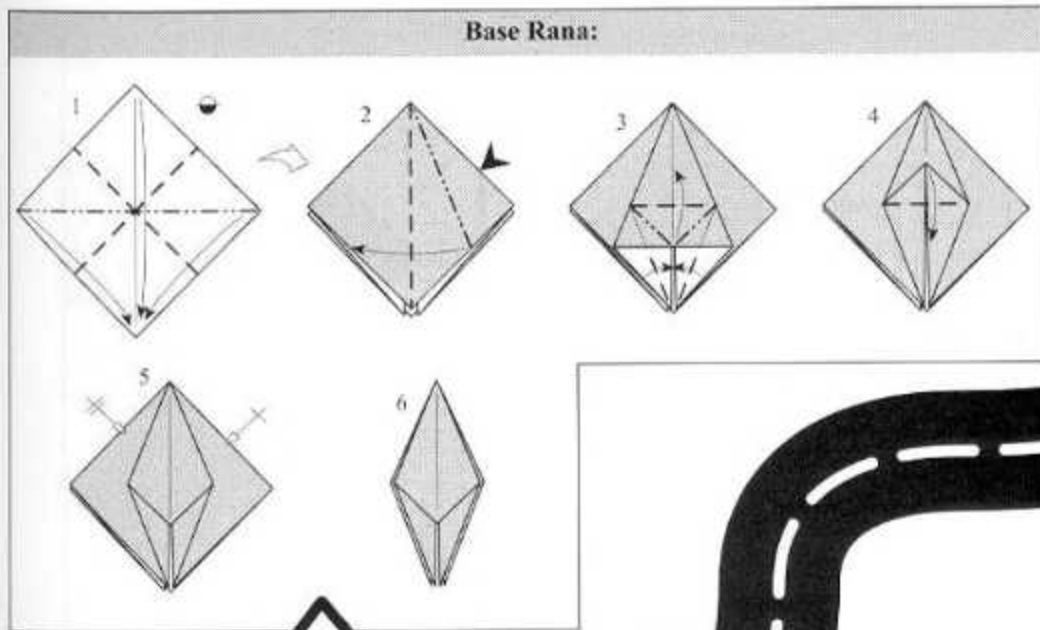

RANA



Base Pájaro estirada:

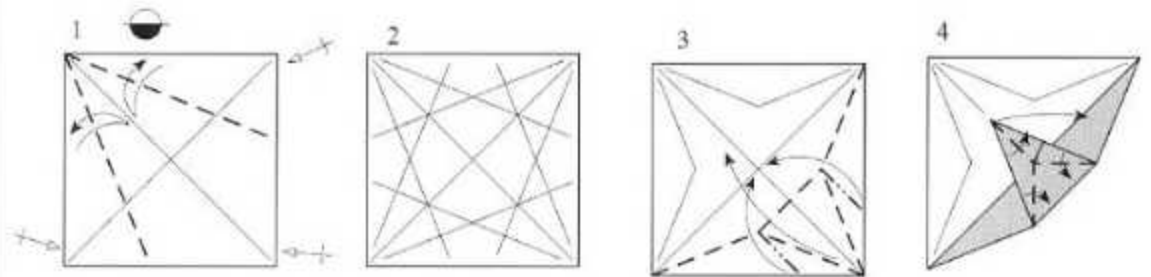

PÁJARO ESTIRADA

5 Repetir 3 y 4.

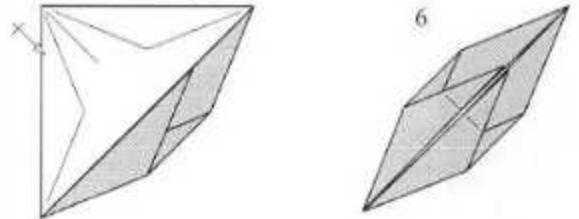

BLINTZ PEZ



Base Blintz Pez:

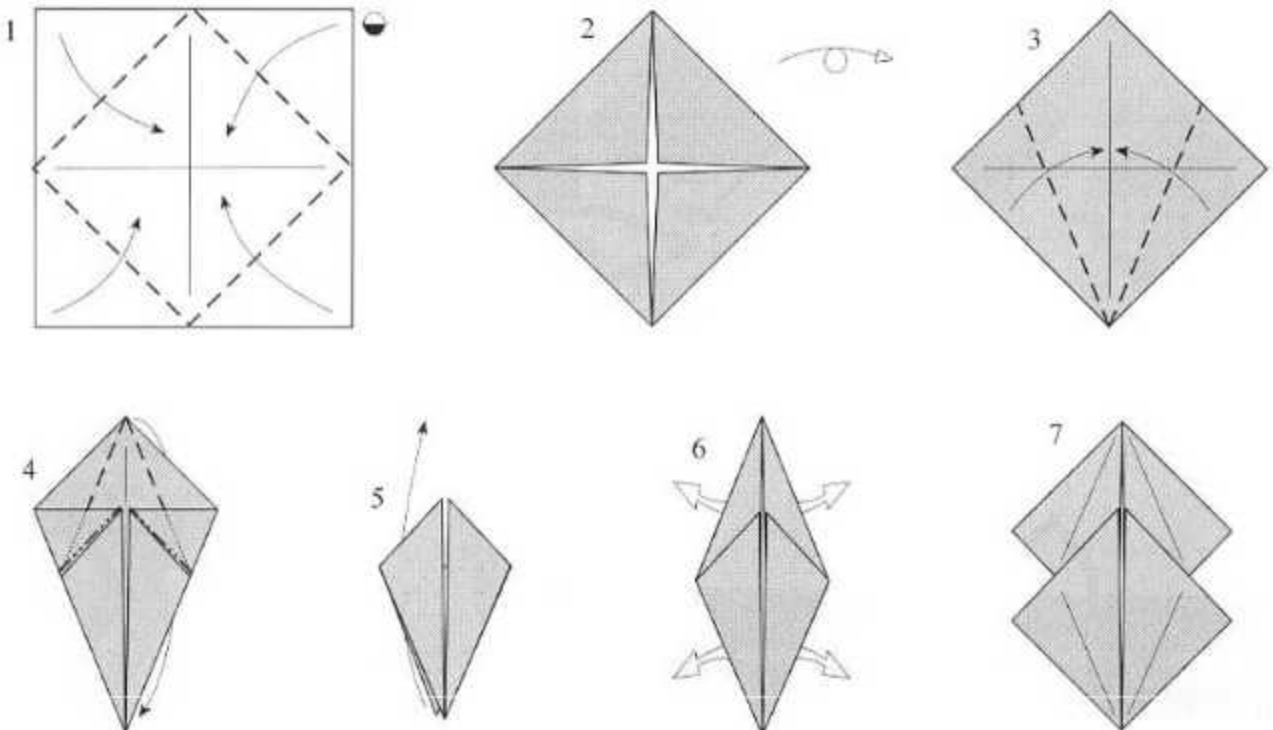

Base Blintz Pájaro:

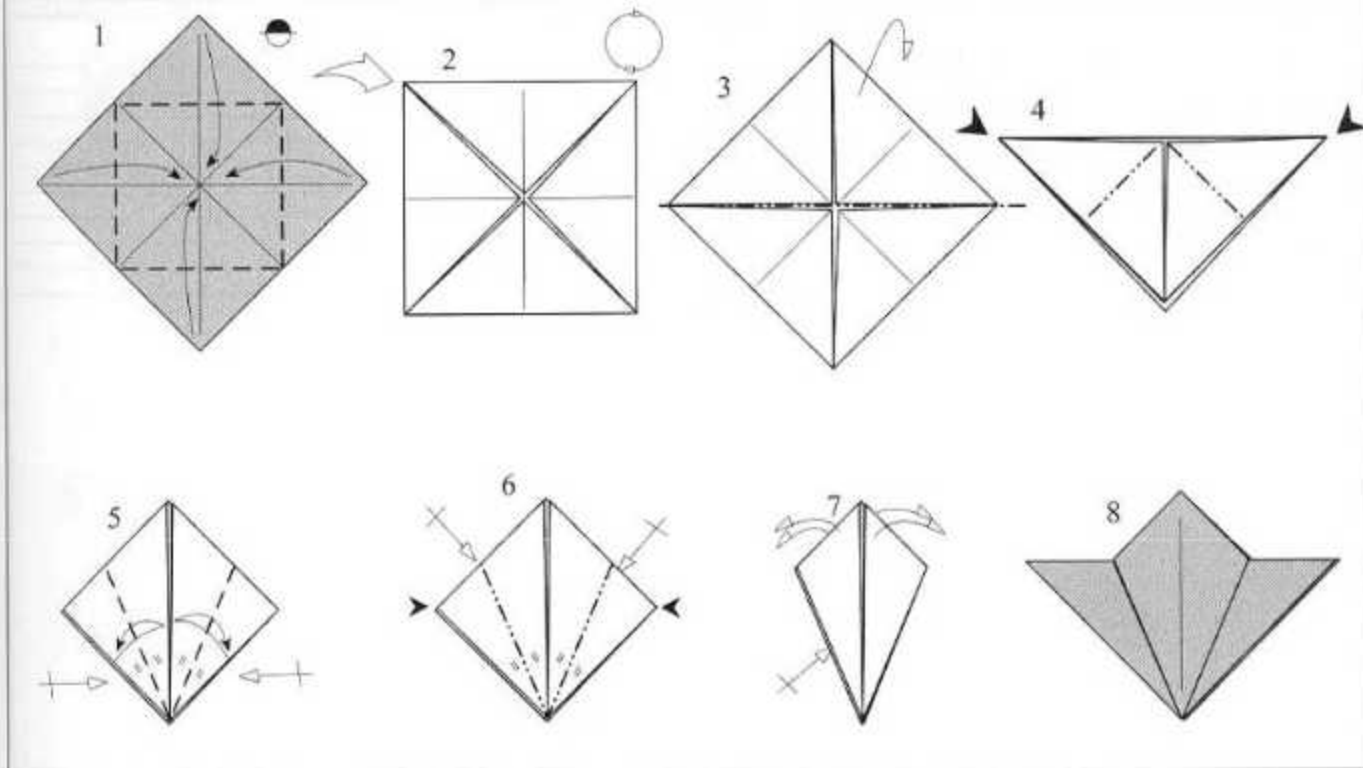

BLINTZ PÁJARO

BLINTZ RANA

Base Blintz Rana:

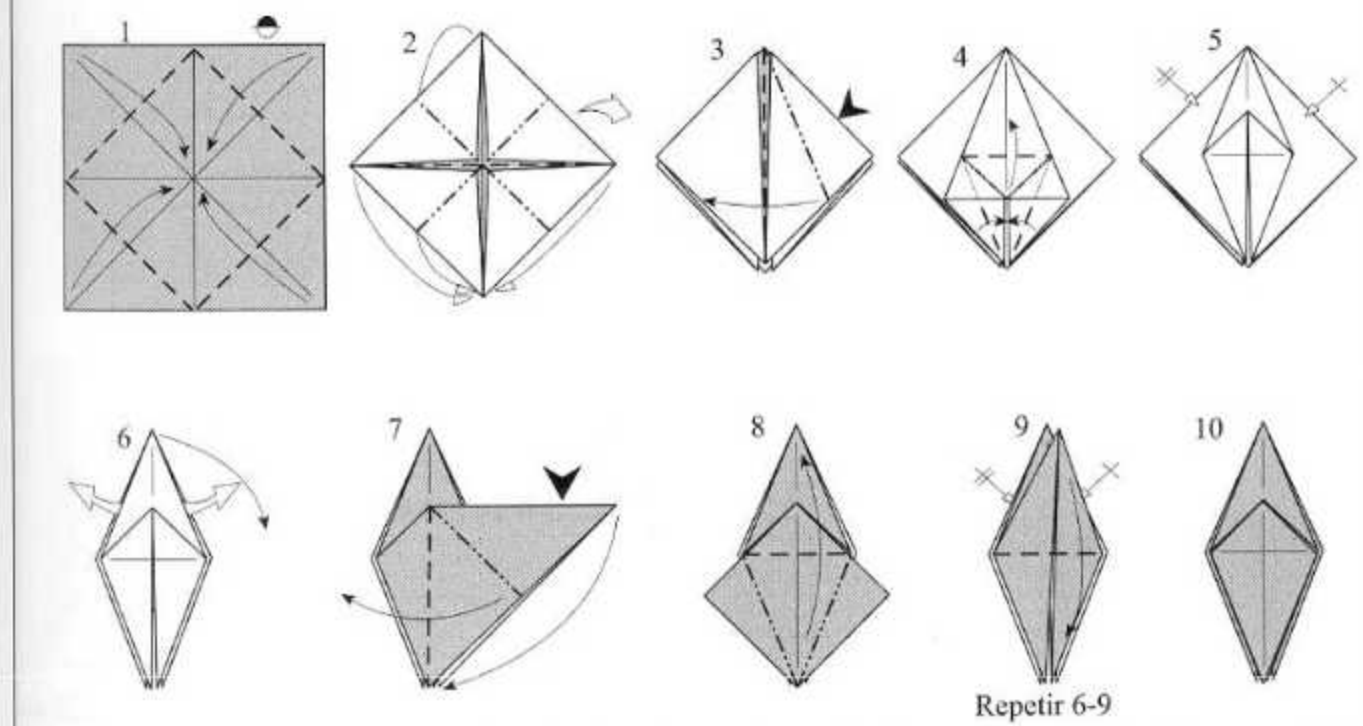

| Página (Desarr.) | Pieza nº | Cantidad | Porción | COLORES | | Tamaño original | Tamaño 2/5 | Tamaño 3/5 | Tamaño 4/5 |
|---------------------|----------|----------|----------------|----------|---------|-----------------|-------------|--------------|--------------|
| | | | | Anverso | Reverso | 24 cm alto | 9,6 cm alto | 14,4 cm alto | 19,2 cm alto |
| | | | | | | Lado (cm) = | Lado (cm) = | Lado (cm) = | Lado (cm) = |
| 13 | 1 | 1 | Cara | Rosa | Negro | 20 | 8 | 12 | 16 |
| 14 | 2 | 1 | Sombrero | Neutro | Marrón | 20 | 8 | 12 | 16 |
| 15 | 3 | 1 | Camisa | Amarillo | Negro | 20 | 8 | 12 | 16 |
| 15 | 4 | 1 | Ojos | Negro | Blanco | 5 | 2 | 3 | 4 |
| 16 | 5 | 1 | Pañuelo cuello | Neutro | Rojo | 5 | 2 | 3 | 4 |
| 17 | 6 | 1 | Nariz | Neutro | Rosa | 5 | 2 | 3 | 4 |
| 17 | 7 | 1 | Pitillo | Negro | Blanco | 5 | 2 | 3 | 4 |
| 18 | 8 | 1 | Pierna/pies | Azul | Marrón | 20 | 8 | 12 | 16 |
| 18 | 9 | 2 | Brazos | Amarillo | Neutro | 10 | 4 | 6 | 8 |
| 19 | 10 | 2 | Manos | Neutro | Rosa | 7,5 | 3 | 4,5 | 6 |

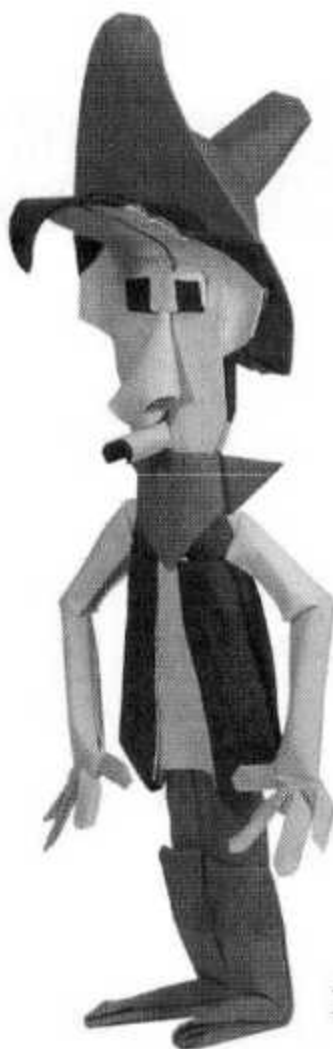

Plegado por: J.A.V.I.



Utilizando las medidas recomendadas, se obtiene un modelo final de 24 cms.

| | |
|-----------------------------|------------|
| Autor: | Halle |
| Nivel de dificultad: | Medio-Alto |
| Número de piezas: | 12 |
| Forma de las piezas: | Cuadrados |

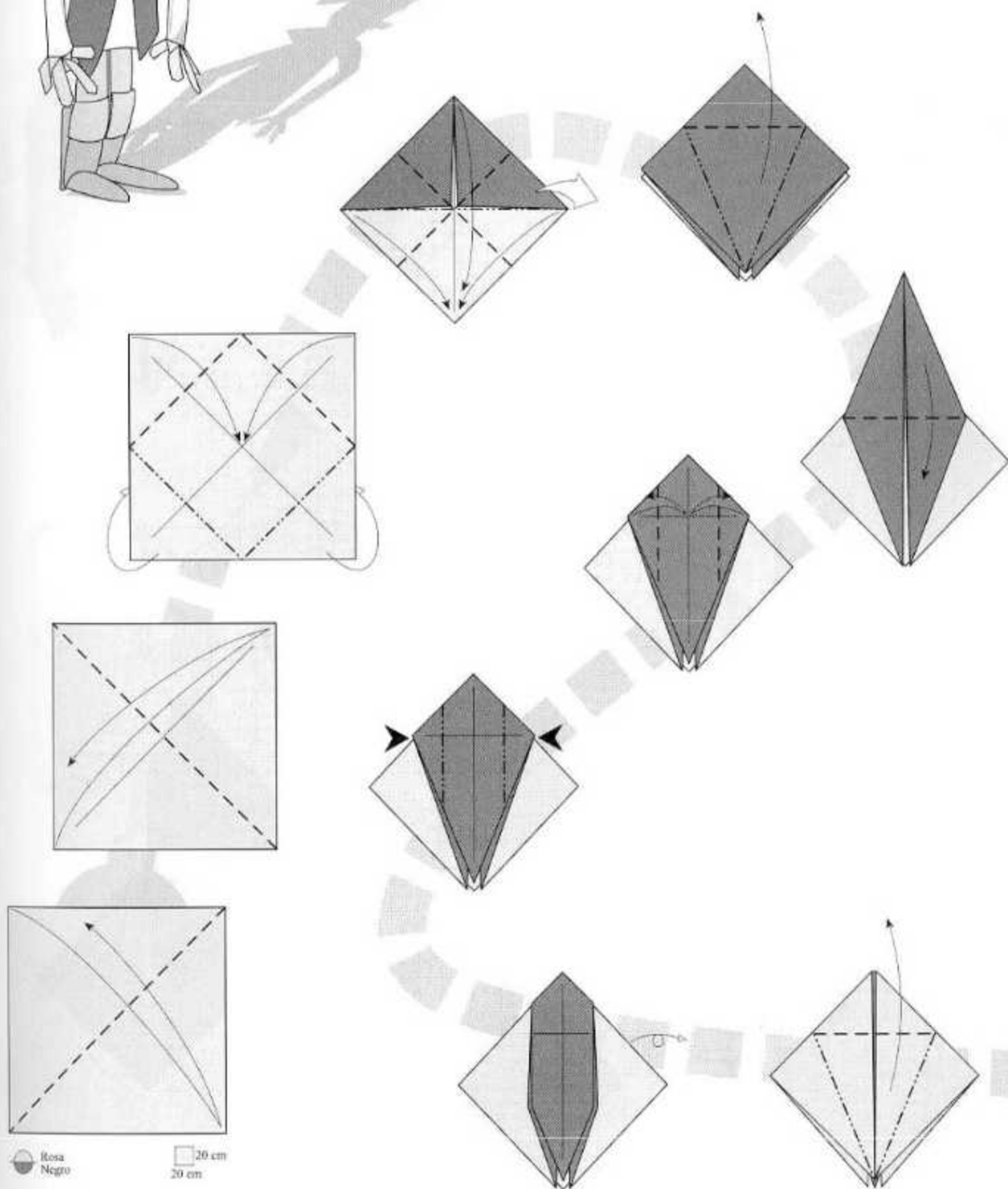

 Rosa
 Negro
 20 cm
 20 cm



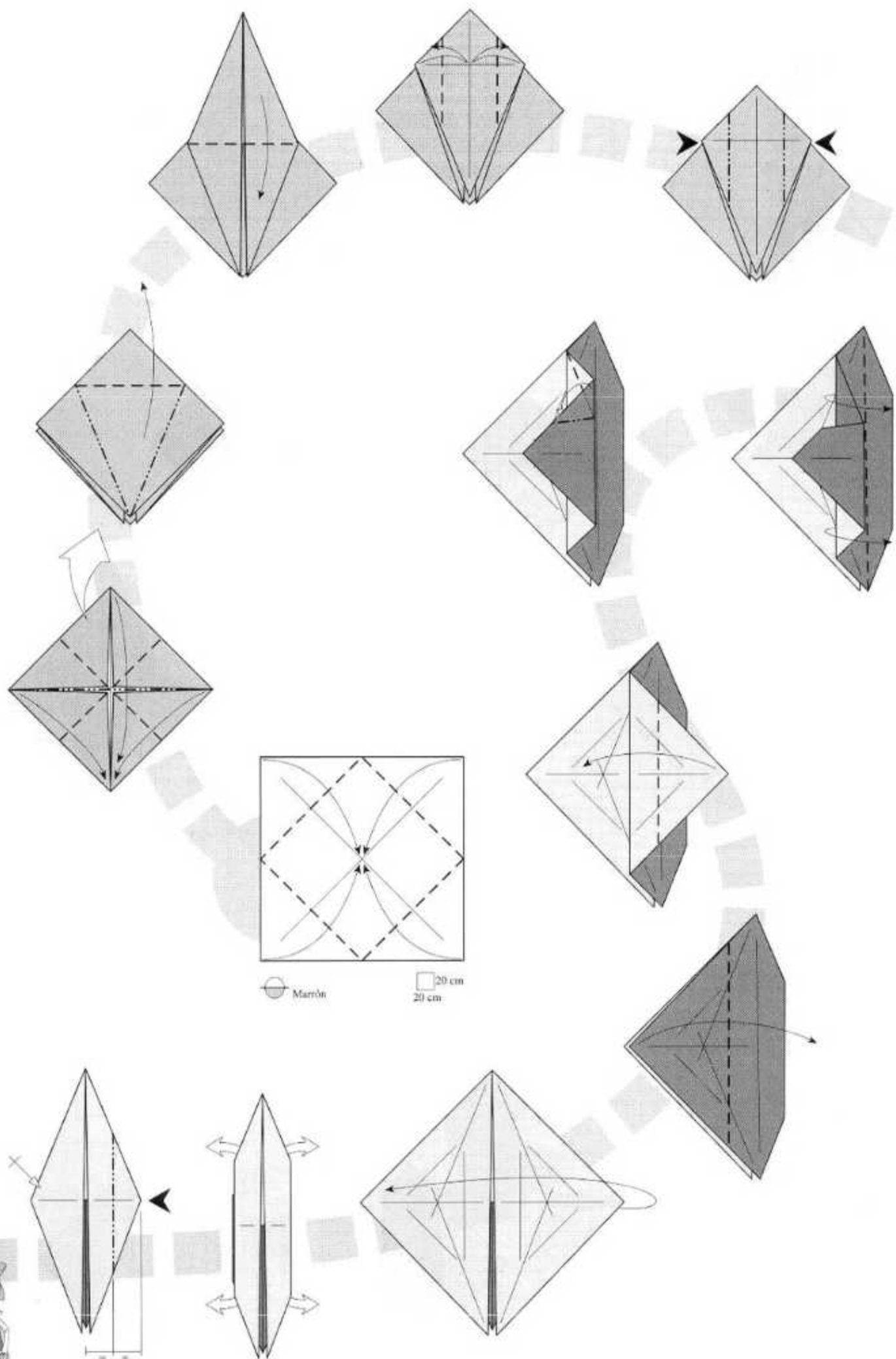

● Marrón

□ 20 cm



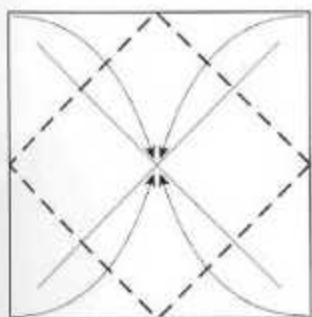
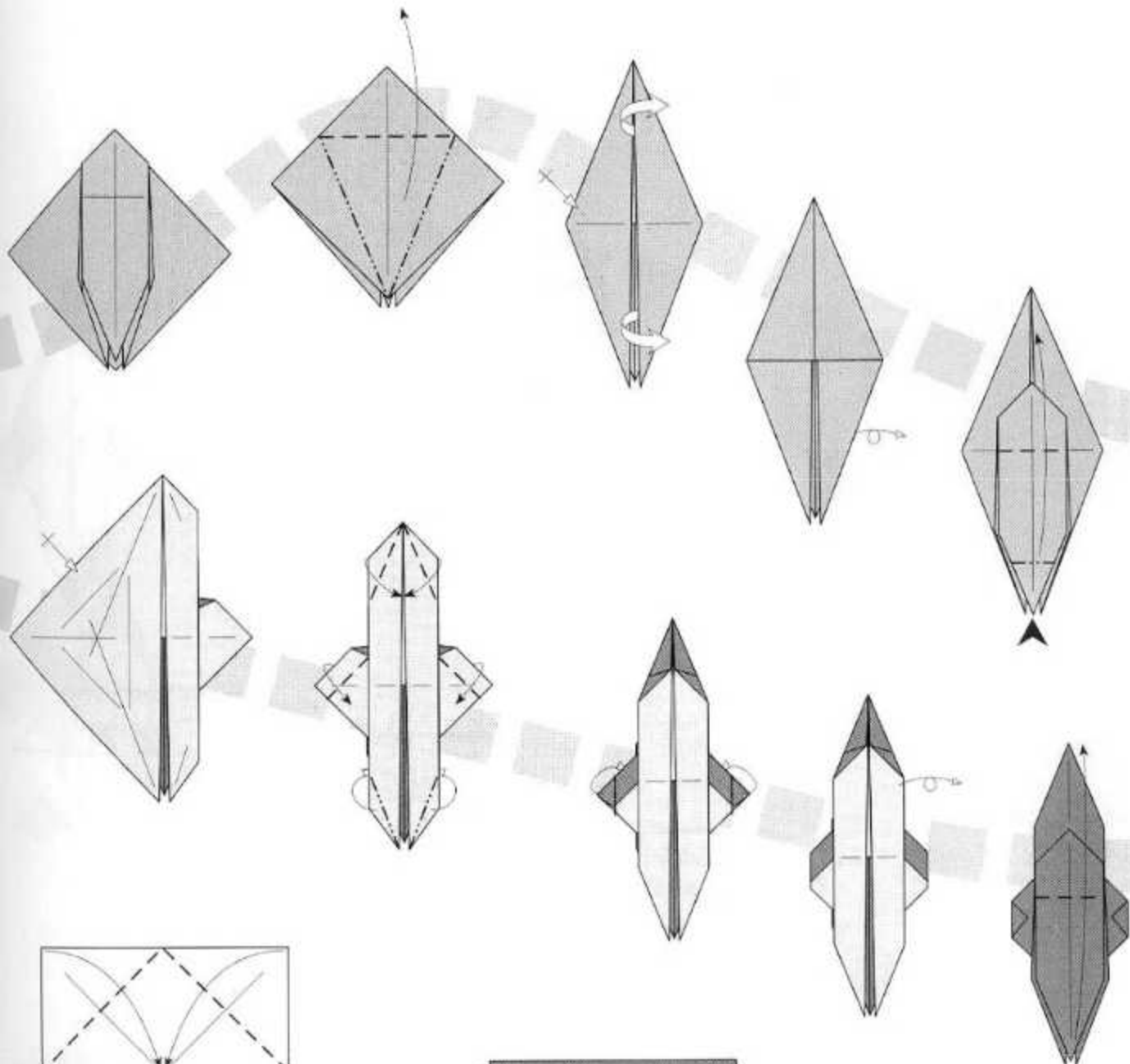

20 cm
 Negro

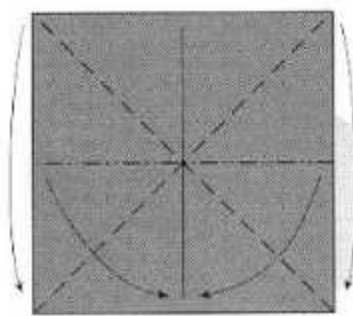

Blanco
 5 cm

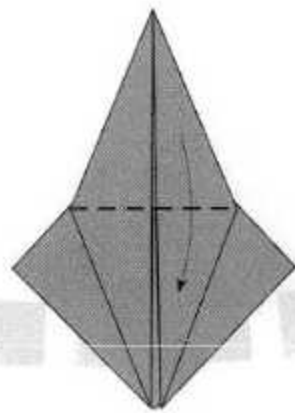
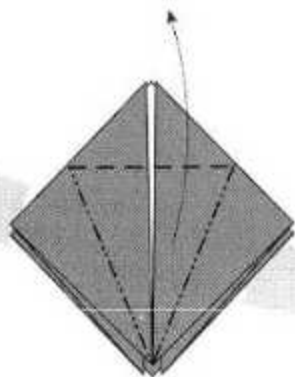
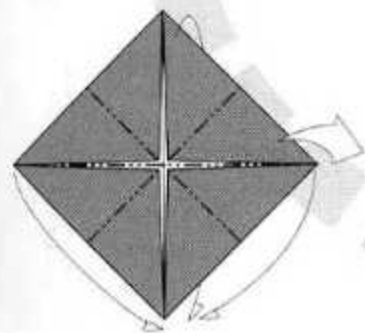
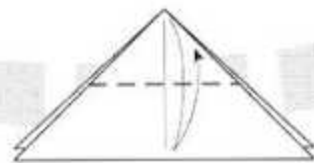

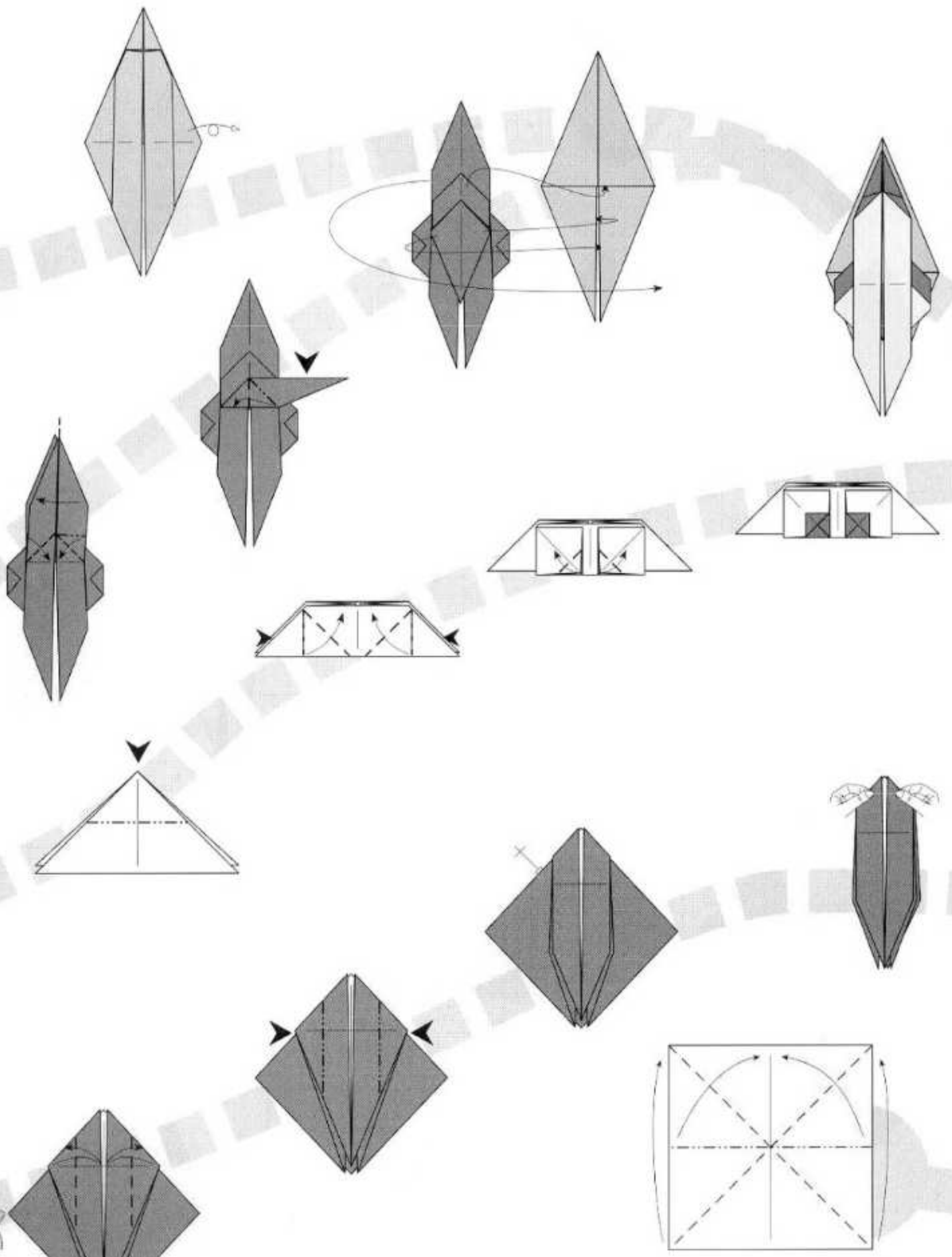

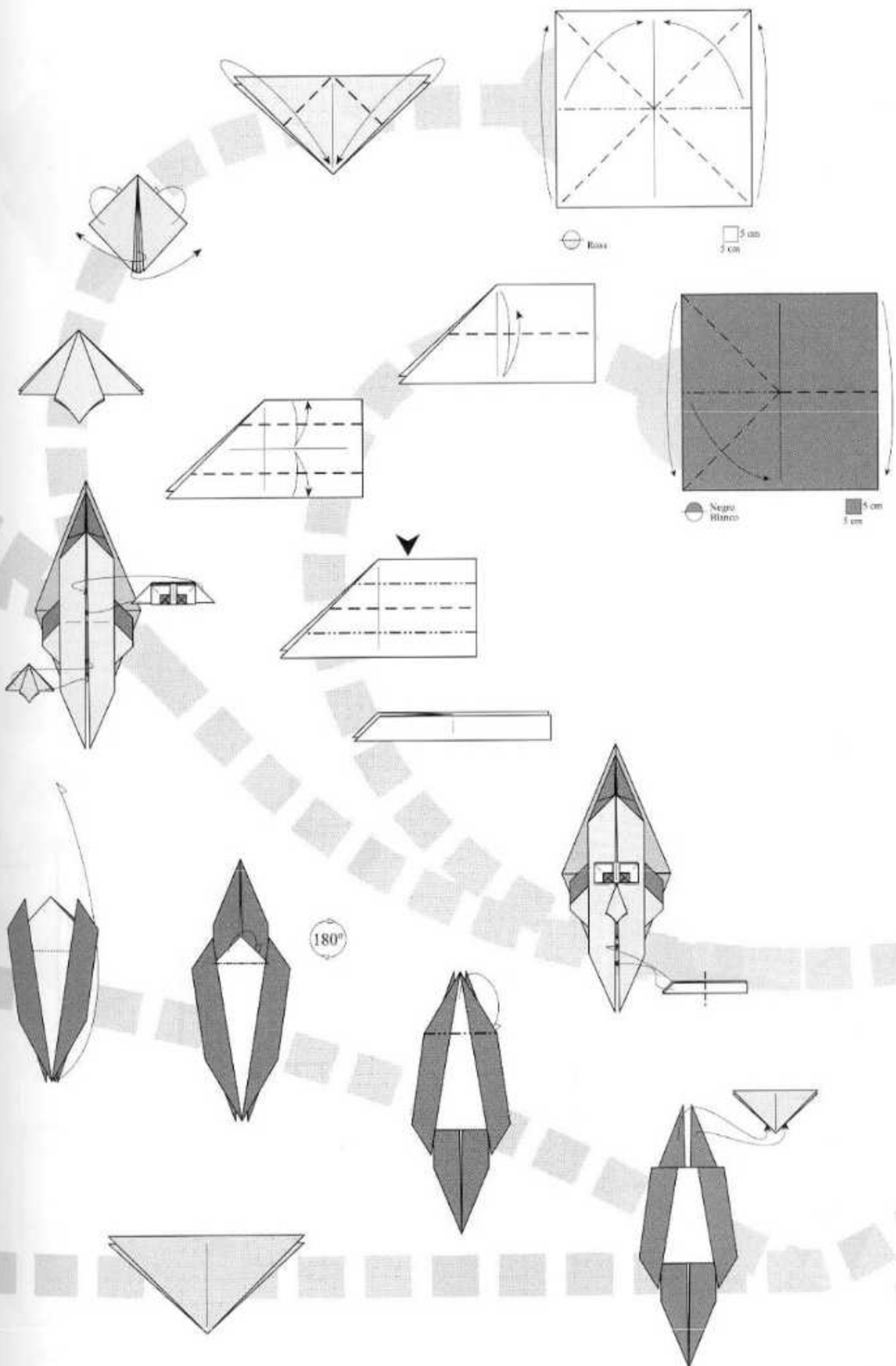

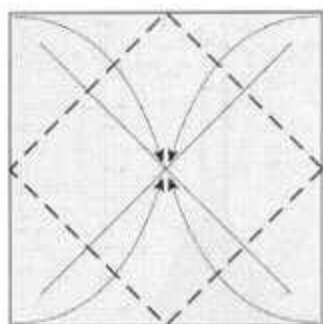

● Azul
● Marrón

□ 20 cm
□ 20 cm

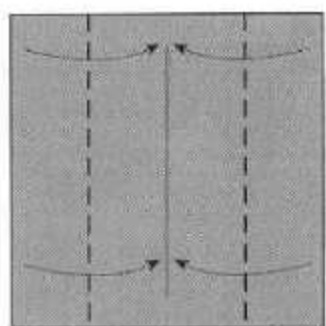
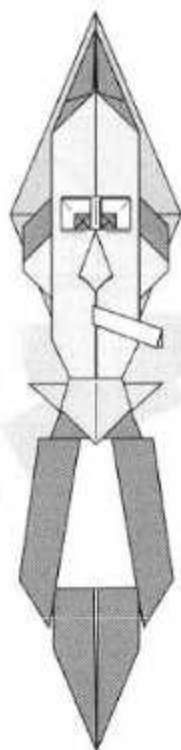
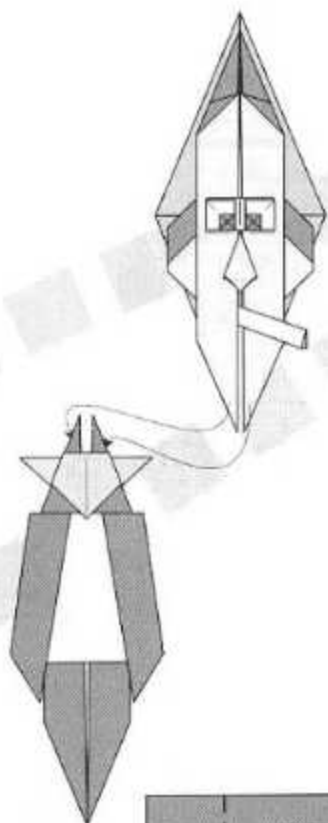
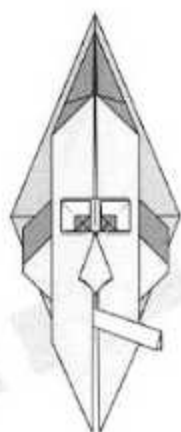
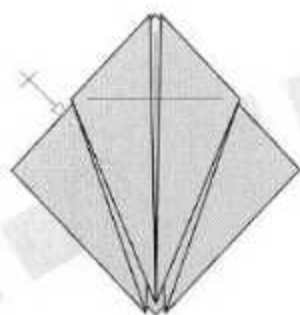
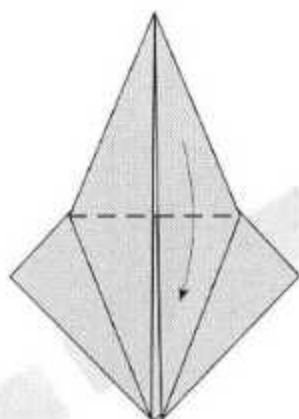
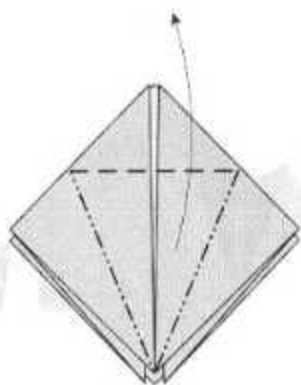
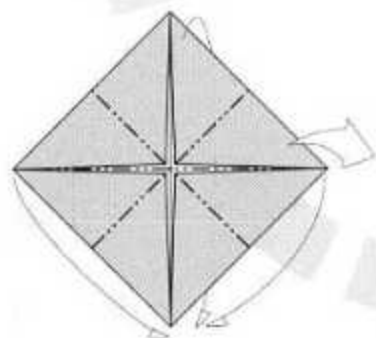

● Amarillo

■ 10 cm
■ 10 cm



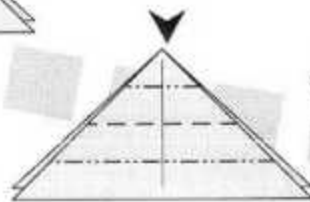
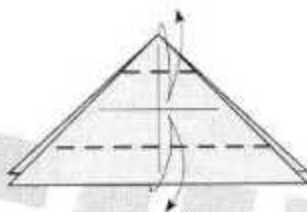
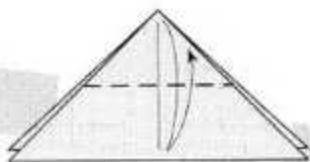
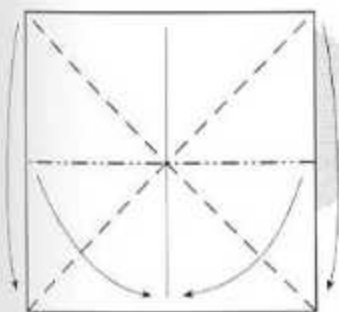
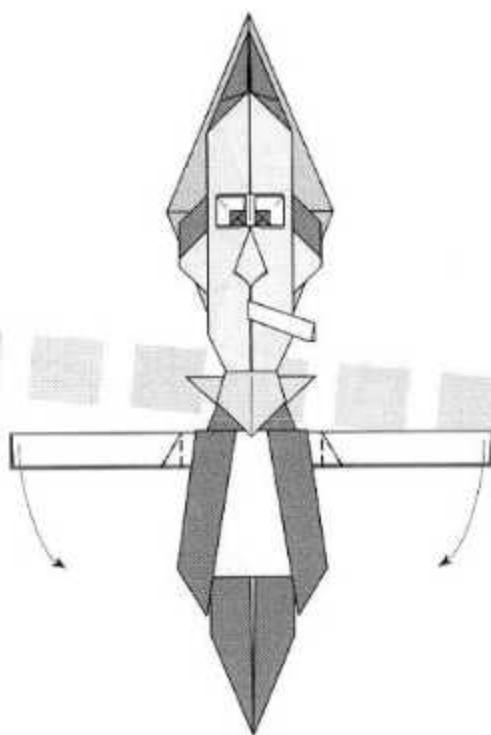
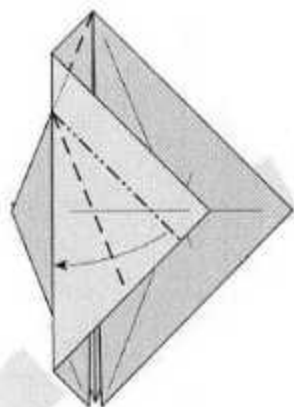
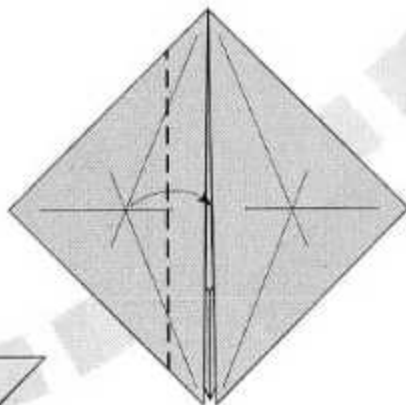
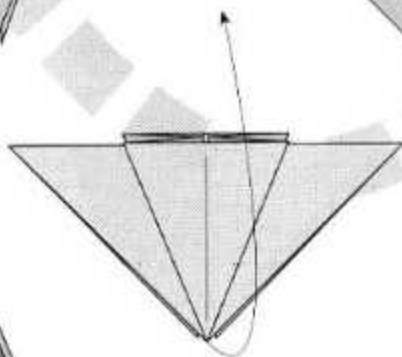
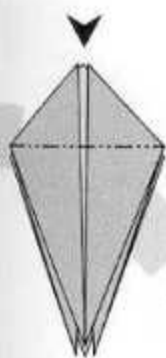

⊕ Rosa

7.5 cm
7.5 cm



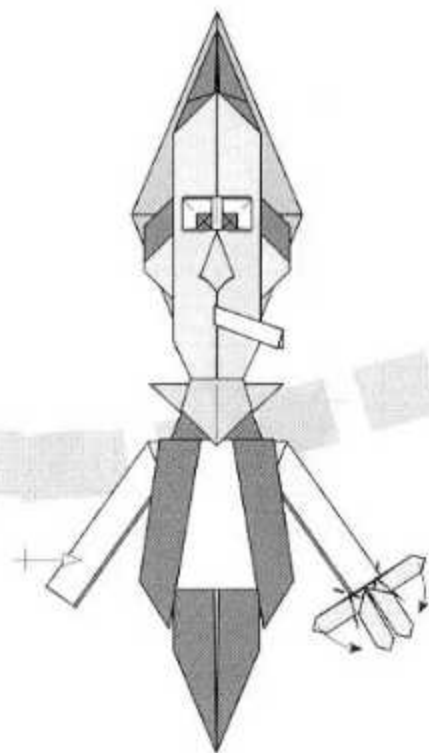
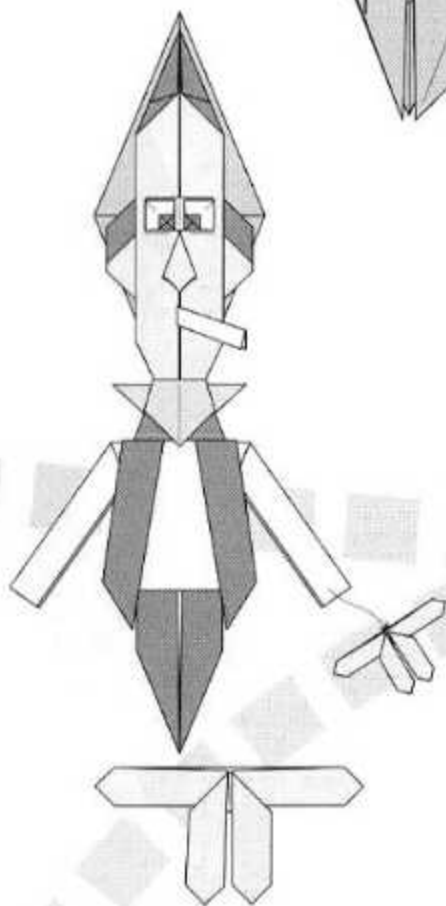
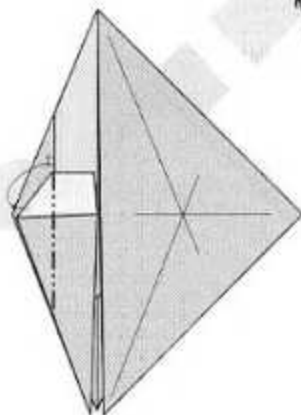
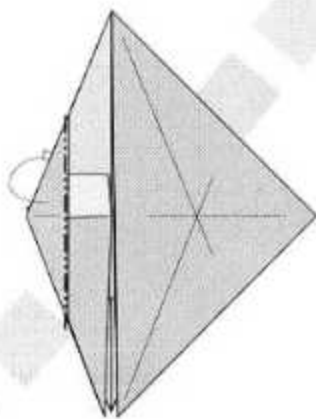
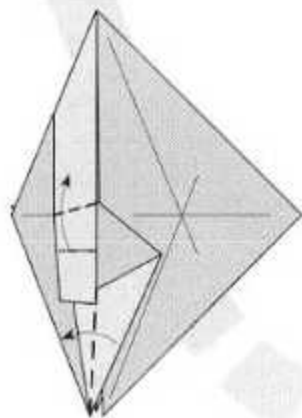
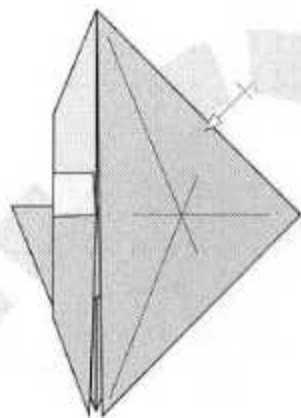
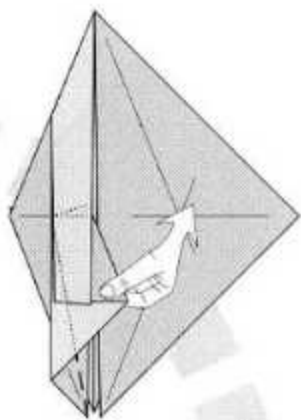

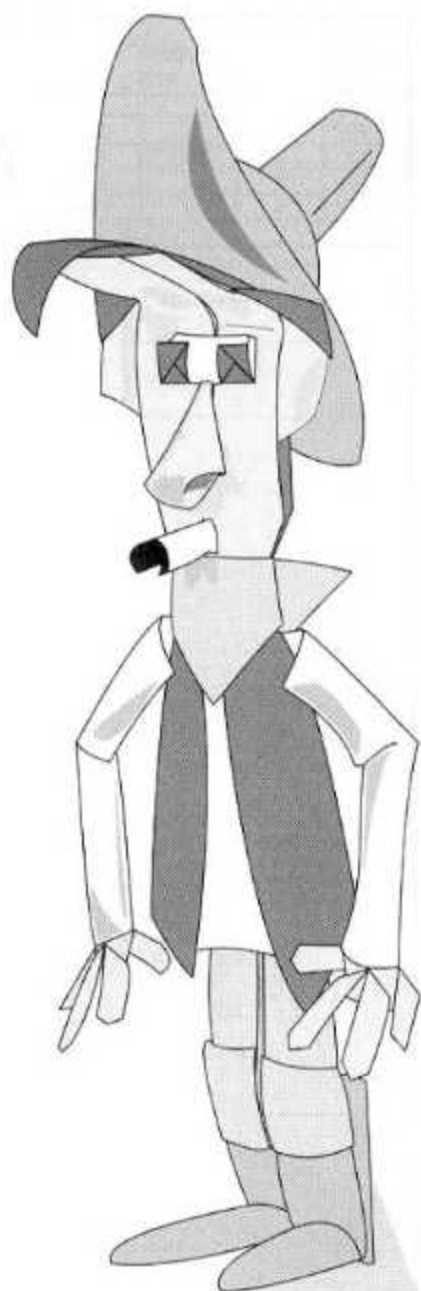
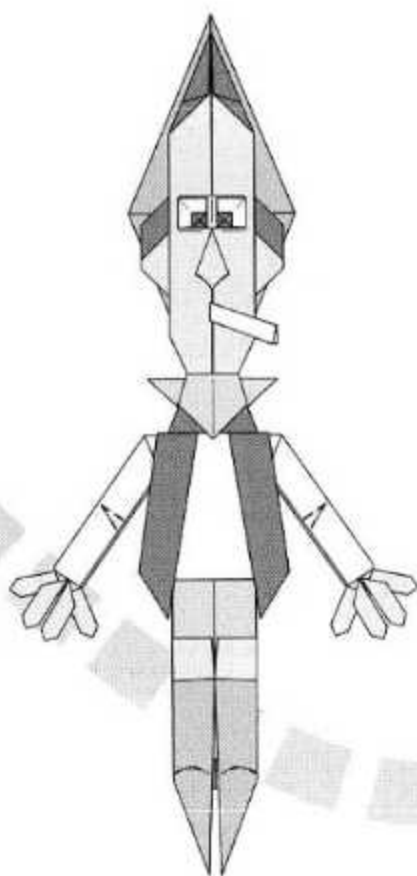
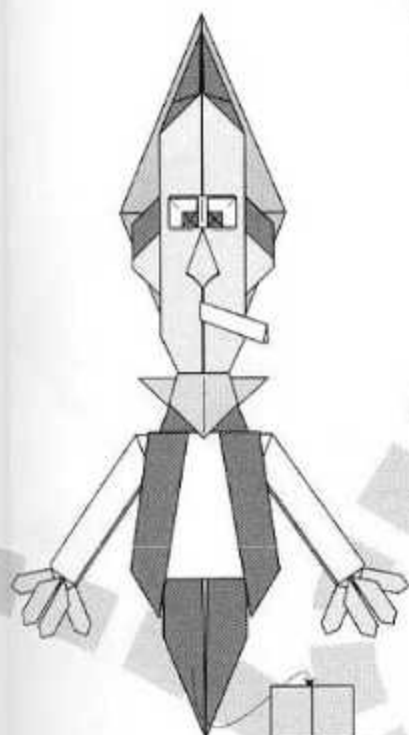
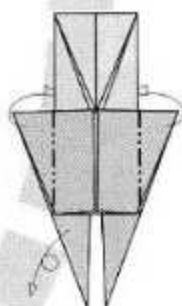
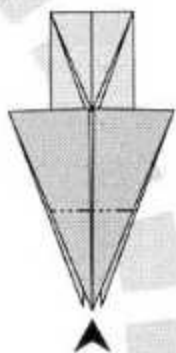
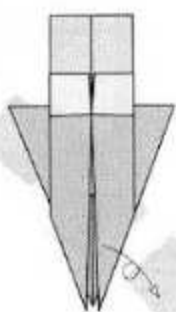
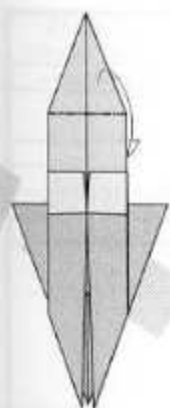

| Página (Desarr.) | Pieza nº | Cantidad | Porción | COLORES | | Tamaño original | Tamaño 3/10 | Tamaño 2/5 | Tamaño 3/5 |
|---------------------|----------|----------|---------|---------|---------|-----------------|-------------|-------------|-------------|
| | | | | Anverso | Reverso | 14 cm alto | 4,2 cm alto | 5,6 cm alto | 8,4 cm alto |
| | | | | | | Lado (cm) = | Lado (cm) = | Lado (cm) = | Lado (cm) = |
| 23 | 1 | 1 | Cabeza | Rojo | Verde | 15 | 4,5 | 6 | 9 |
| 23 | 2 | 2 | Brazos | Neutro | Verde | 10 | 3 | 4 | 6 |
| 23 | 3 | 1 | Cuerpo | Verde | Neutro | 20 | 6 | 8 | 12 |
| 24 | 4 | 2 | Piernas | Neutro | Verde | 15 | 4,5 | 6 | 9 |
| 25 | 5 | 2 | Ojos | Negro | Bianco | 5 | 1,5 | 2 | 3 |

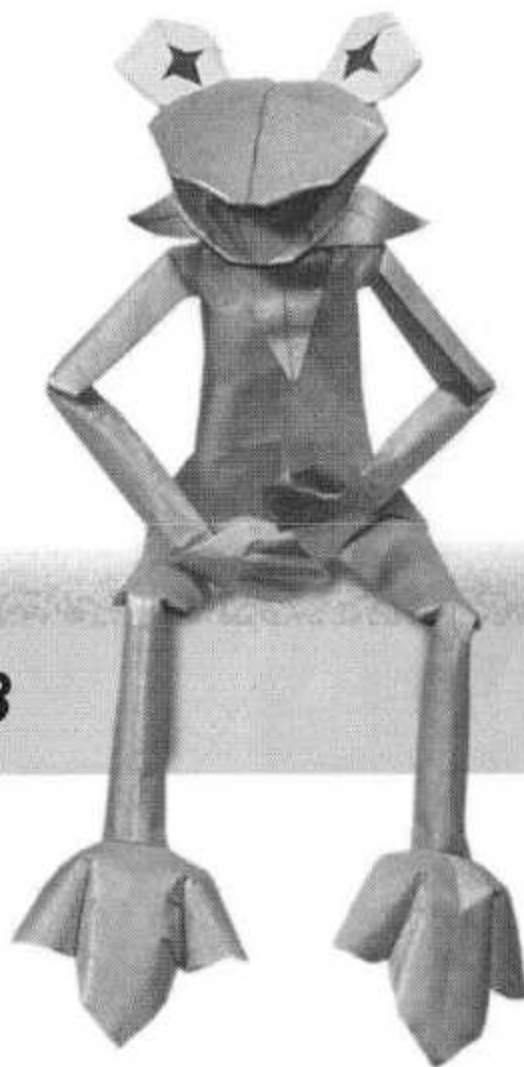

Cartoon Origami 3

Plegado por: J.A.V.I.



Utilizando las medidas recomendadas, se obtiene un modelo final de 14 cms.

| | |
|-----------------------------|------------|
| Autor: | Halle |
| Nivel de dificultad: | Medio-Bajo |
| Número de piezas: | 8 |
| Forma de las piezas: | Cuadrados |

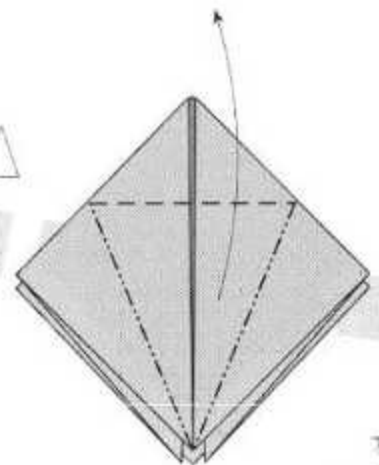
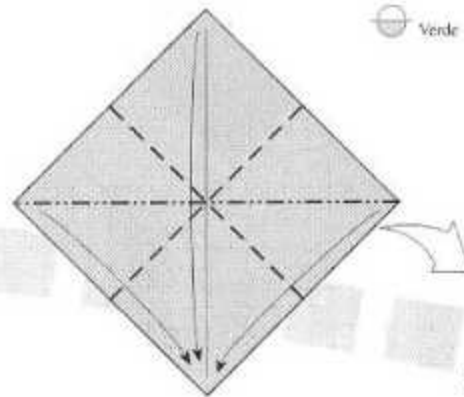
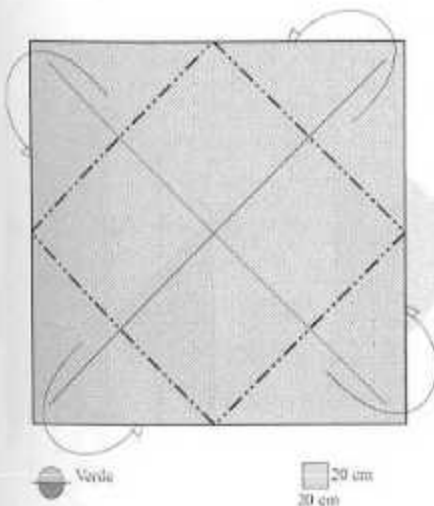
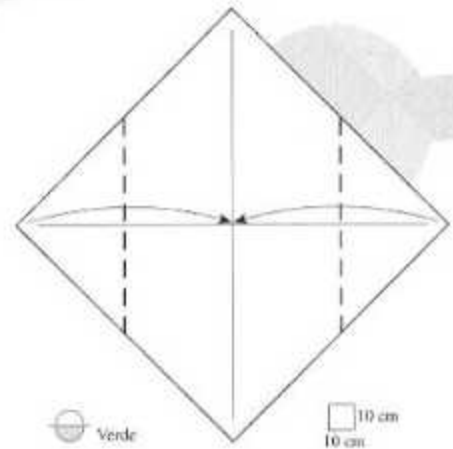
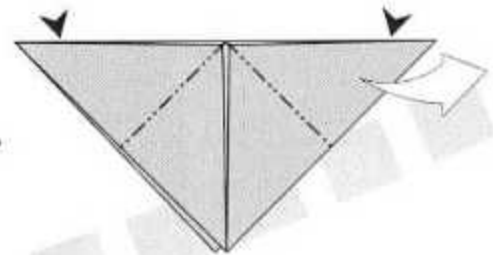
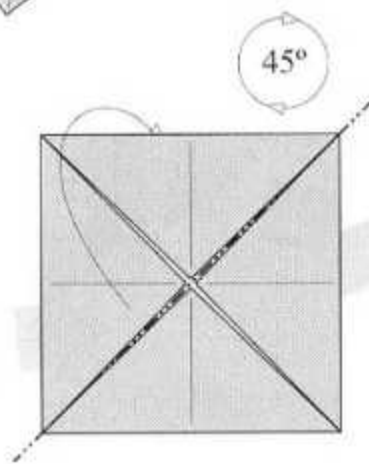
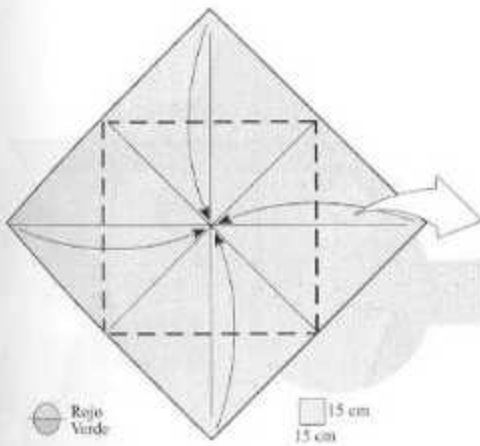

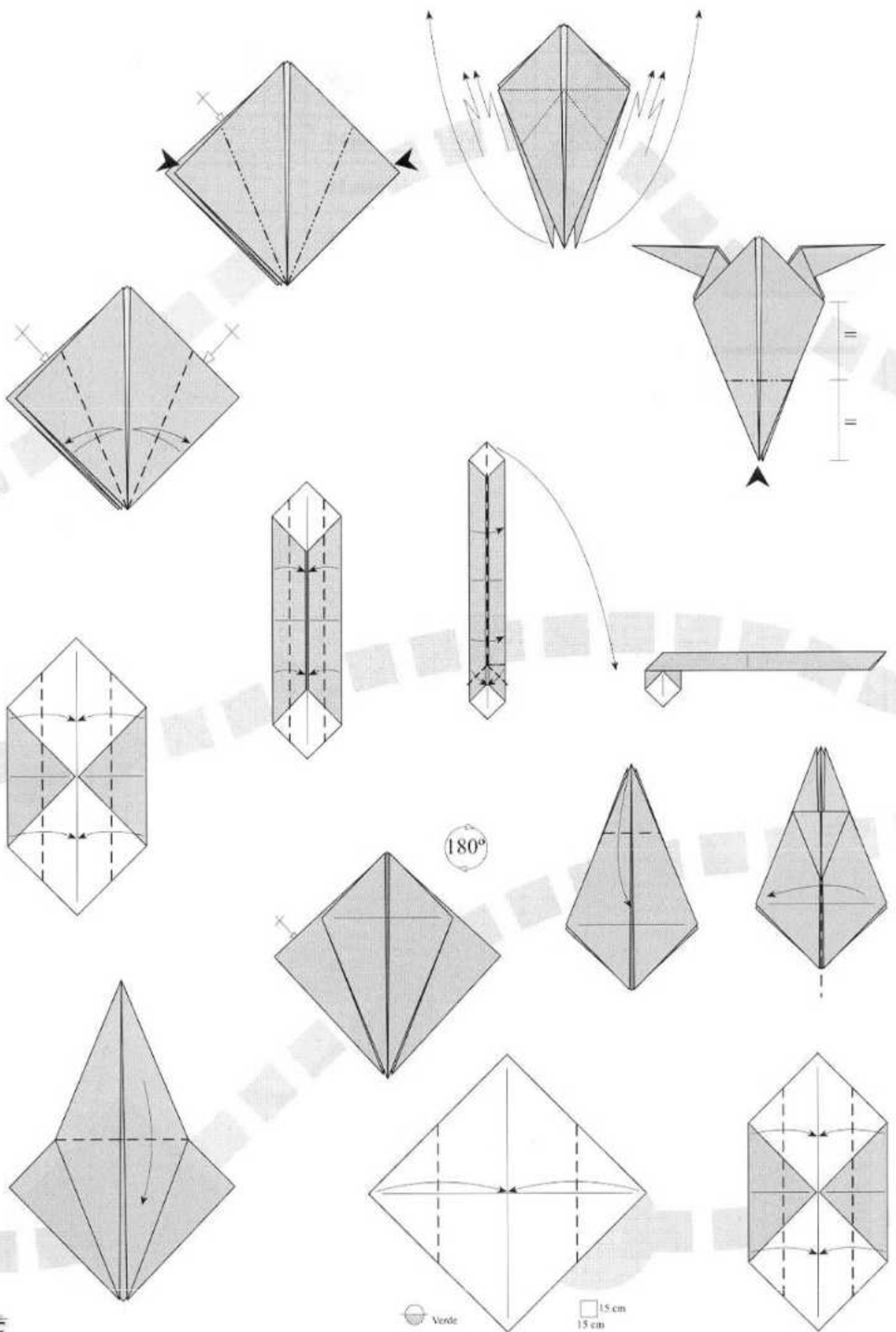

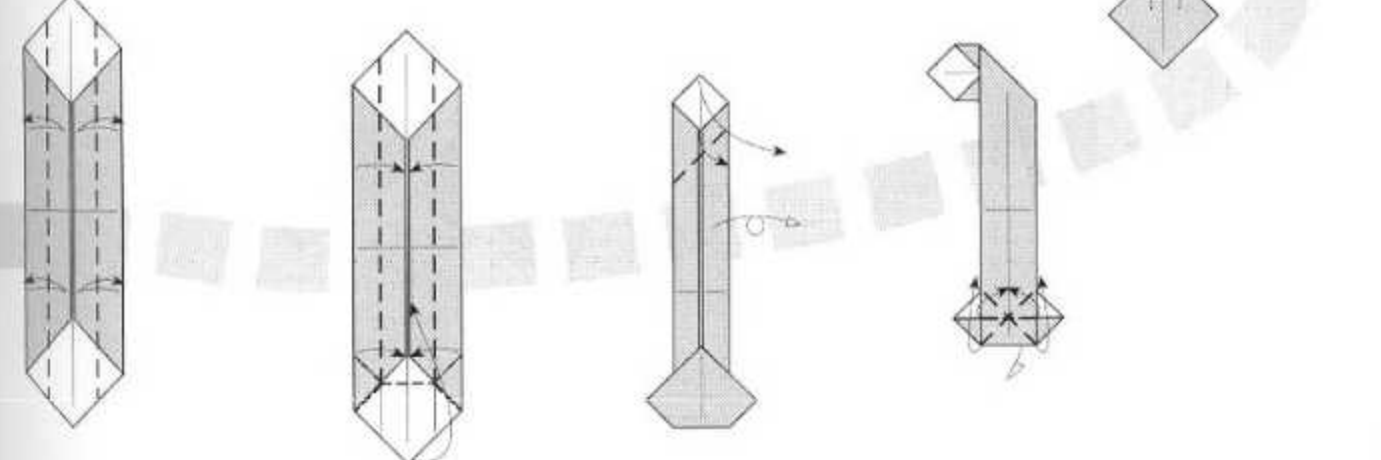
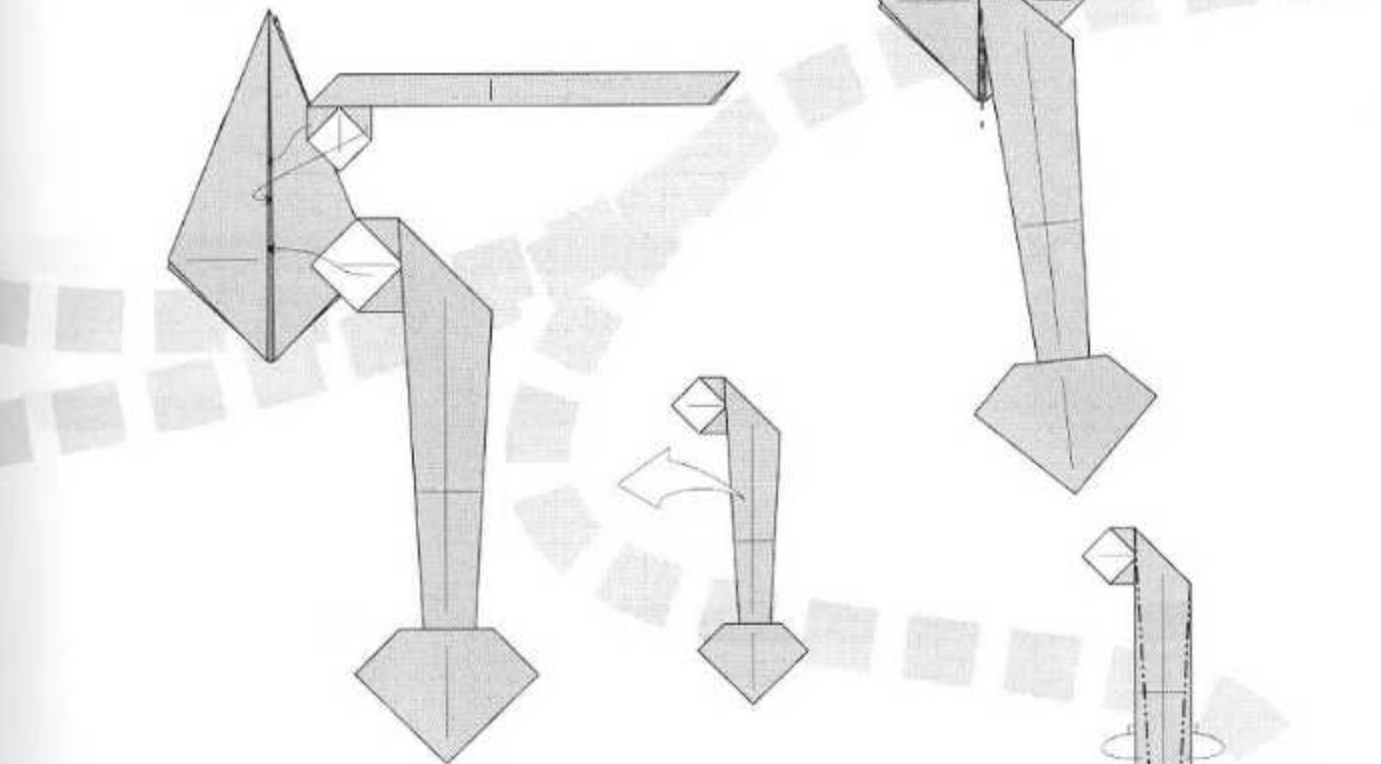
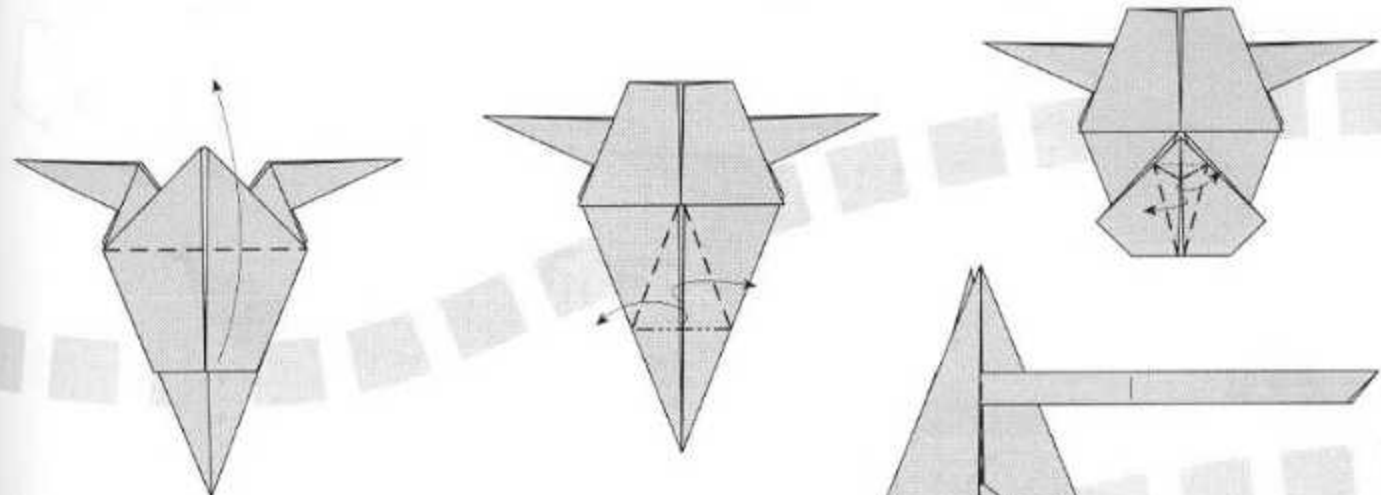
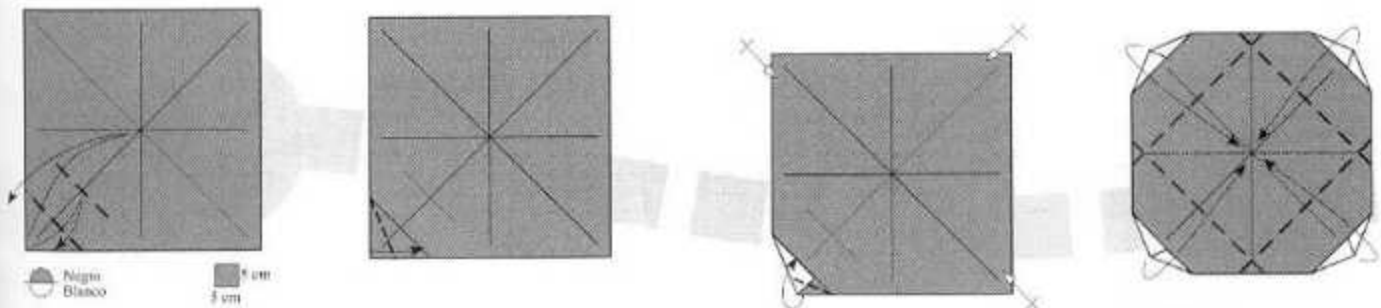

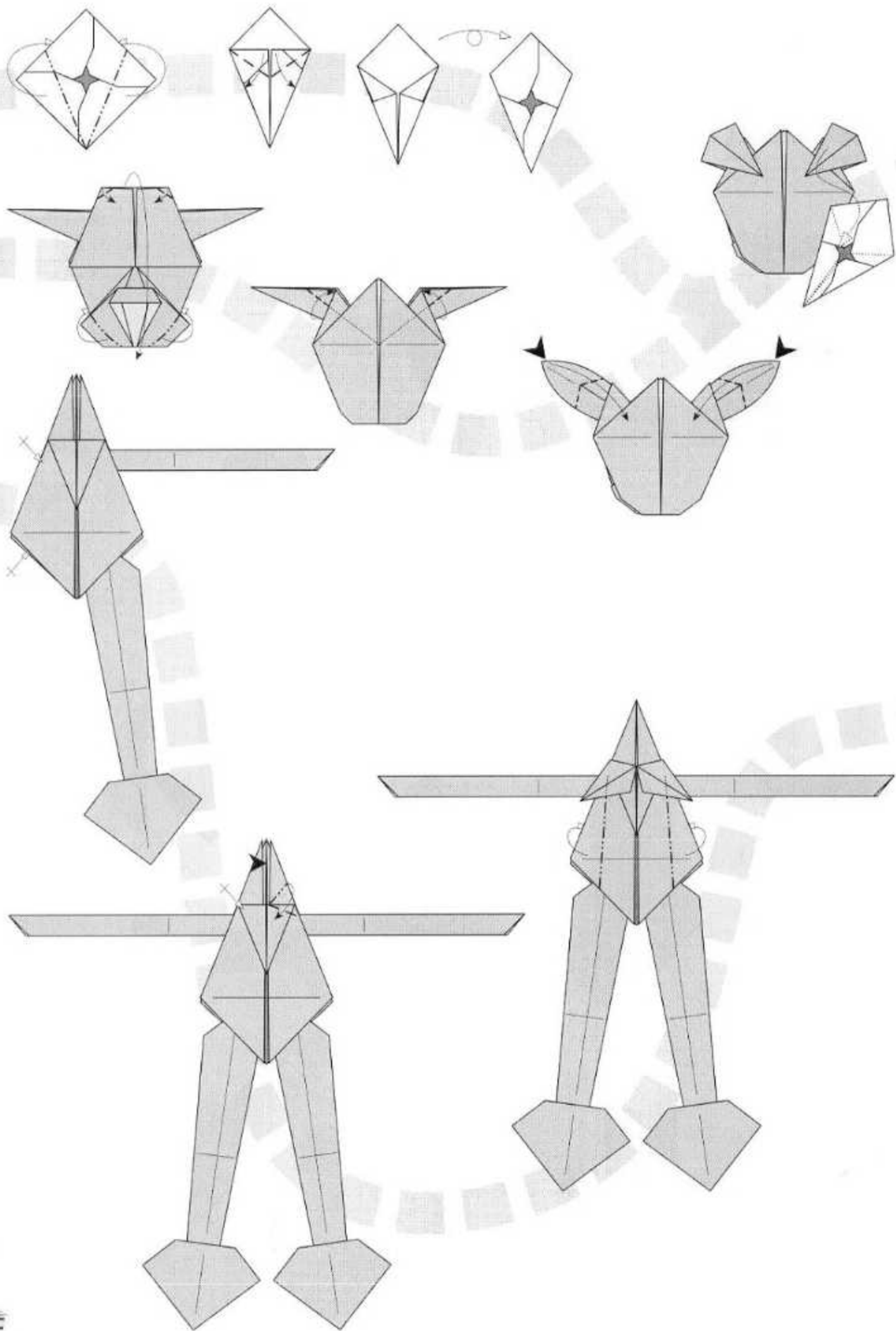

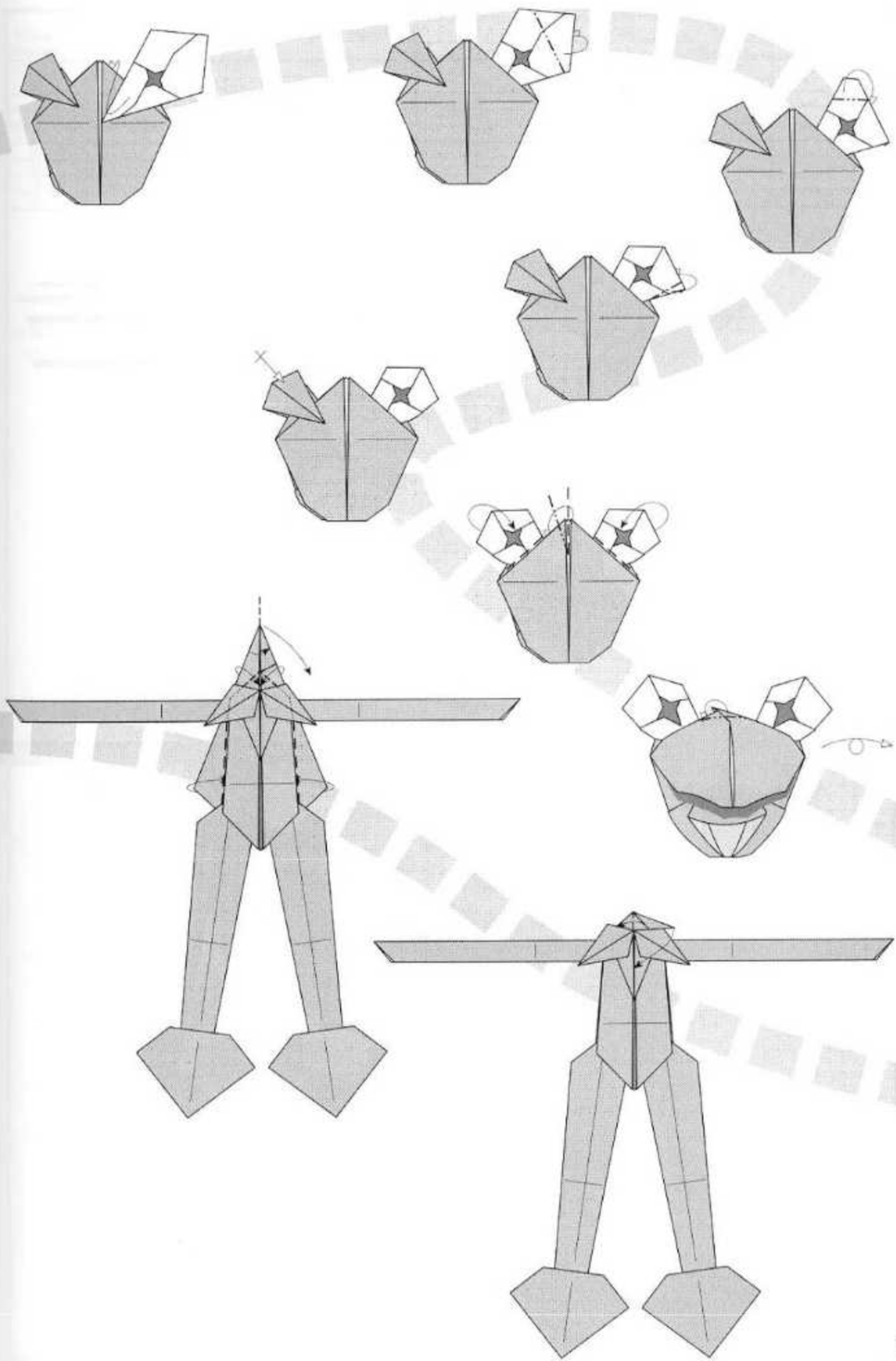

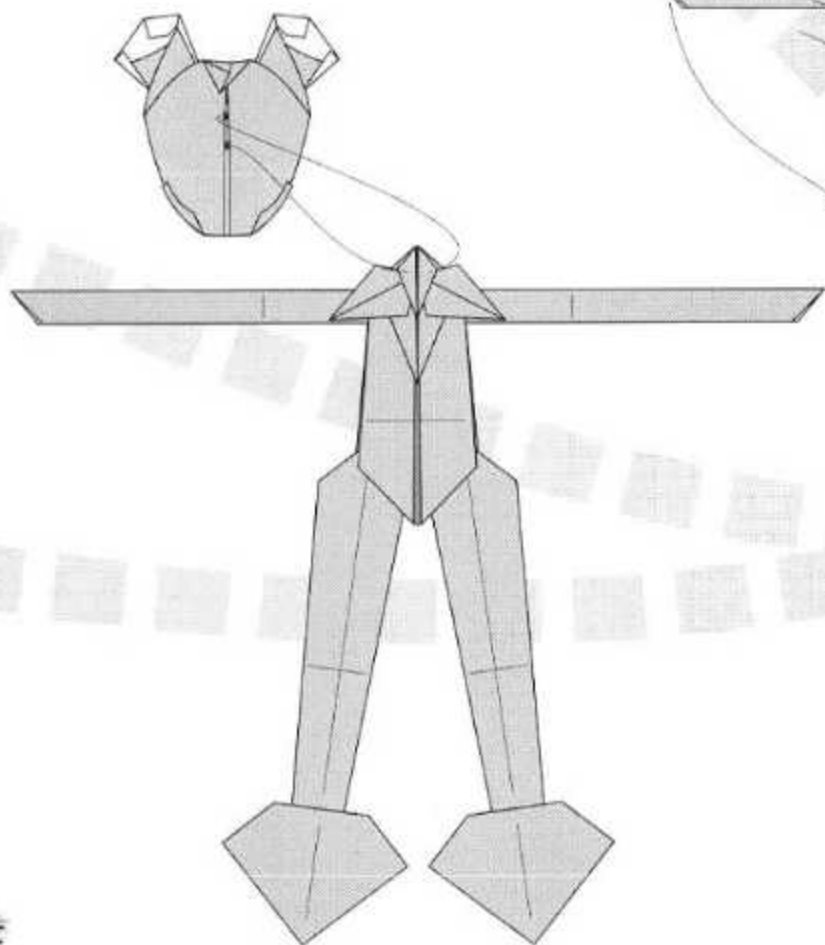
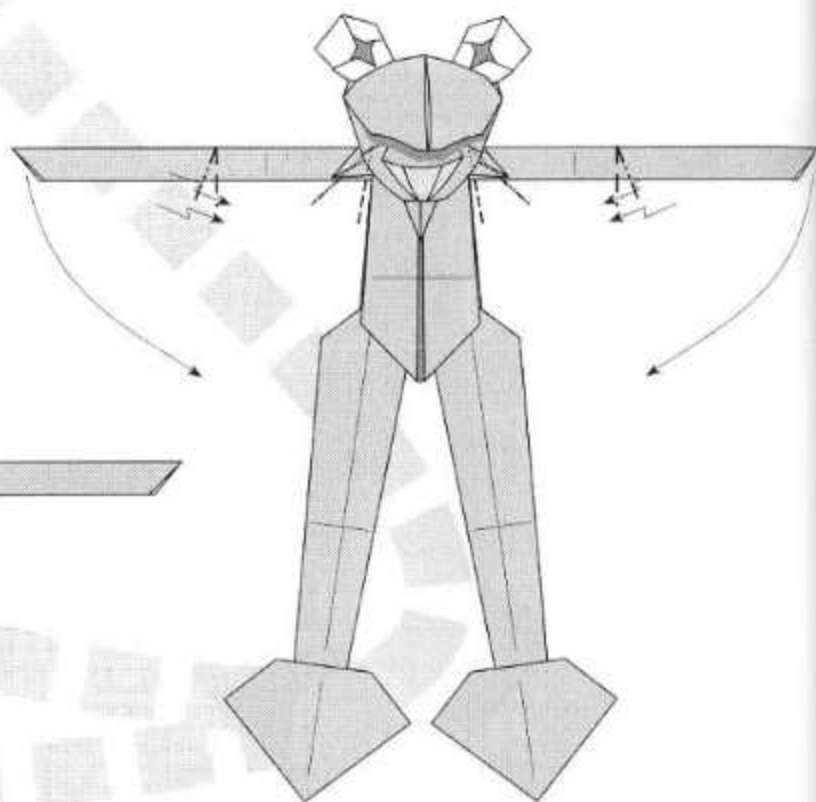
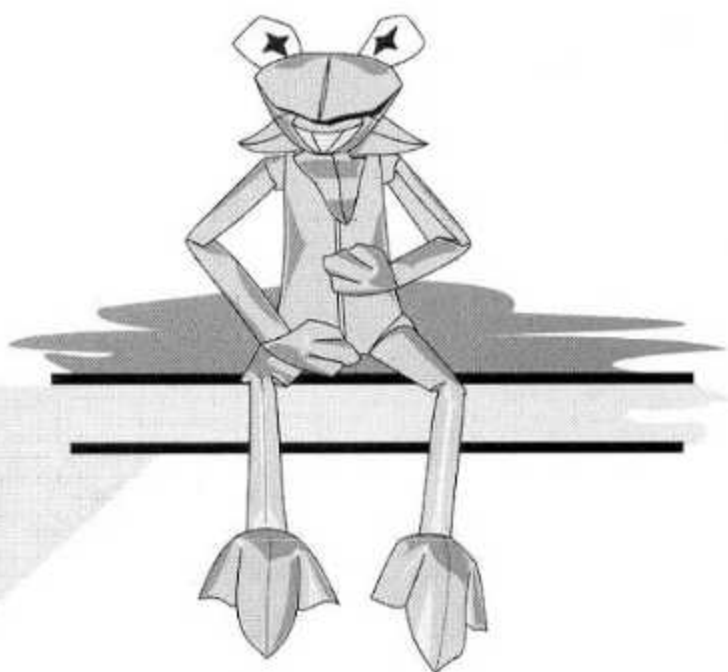
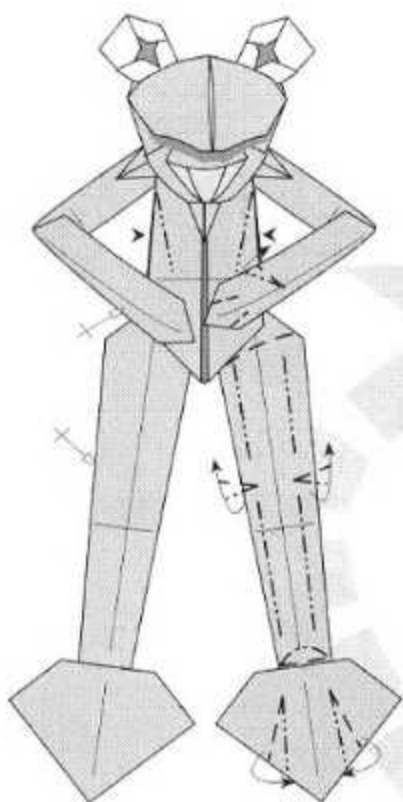

| Página (Desarr.) | Pieza nº | Cantidad | Porción | COLORES | | Tamaño original | Tamaño 3/10 | Tamaño 2/5 | Tamaño 3/5 |
|---------------------|----------|----------|---------------|---------|---------------|-----------------|-------------|-------------|-------------|
| | | | | Anverso | Reverso | 16 cm alto | 4,8 cm alto | 6,4 cm alto | 9,6 cm alto |
| | | | | | | Lado (cm) = | Lado (cm) = | Lado (cm) = | Lado (cm) = |
| 30 | 1 | 1 | Base cara | Rojo | Naranja | 20 | 6 | 8 | 12 |
| 30 | 2 | 1 | Cuerpo-brazos | Azul | Rayas colores | 25 | 7,5 | 10 | 15 |
| 32 | 3 | 1 | Nariz | Neutro | Rojo | 5 | 1,5 | 2 | 3 |
| 33 | 4 | 2 | Orejas | Neutro | Naranja | 10 | 3 | 4 | 6 |
| 33 | 5 | 1 | Pajarito | Naranja | Amarillo | 5 | 1,5 | 2 | 3 |
| 34 | 6 | 1 | Pelo | Neutro | Negro | 10 | 3 | 4 | 6 |
| 34 | 7 | 1 | Ojos | Negro | Blanco | 5 | 1,5 | 2 | 3 |
| 35 | 8 | 1 | Mano | Neutro | Naranja | 5 | 1,5 | 2 | 3 |

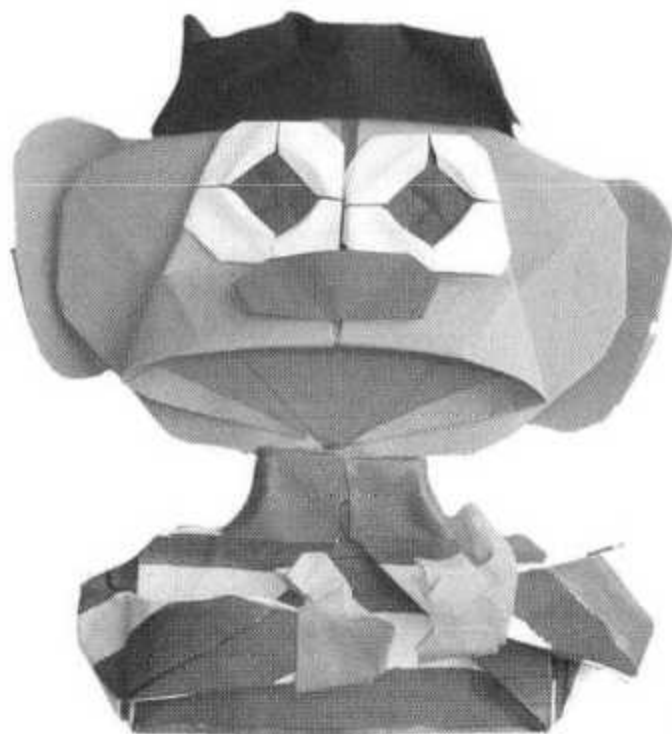

Plegado por: Halle

Utilizando las medidas recomendadas, se obtiene un modelo final de 16 cms.

| | |
|-----------------------------|-----------|
| Autor: | Halle |
| Nivel de dificultad: | Medio |
| Número de piezas: | 9 |
| Forma de las piezas: | Cuadrados |

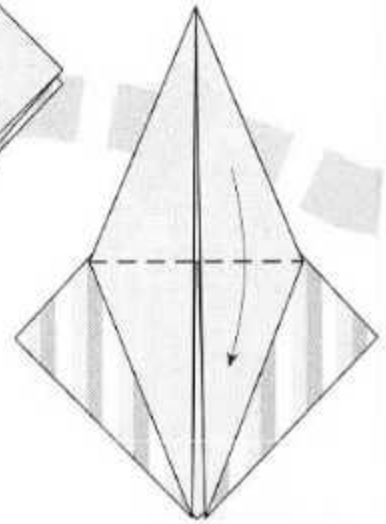
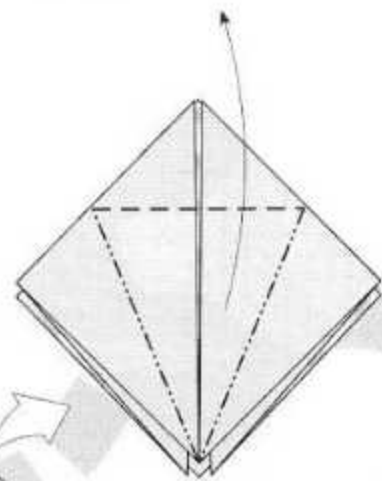
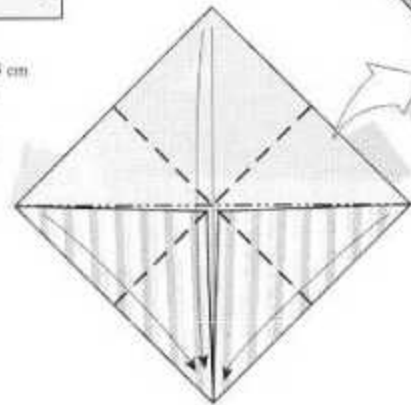
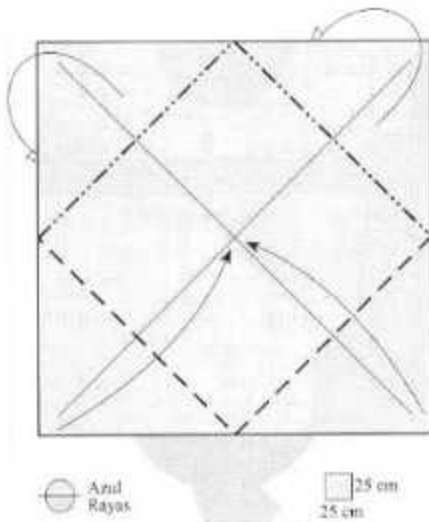
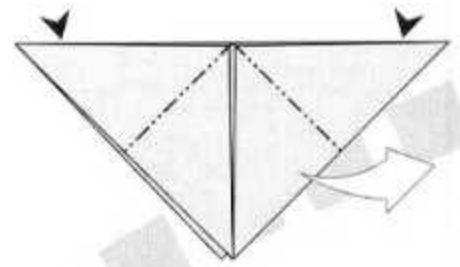
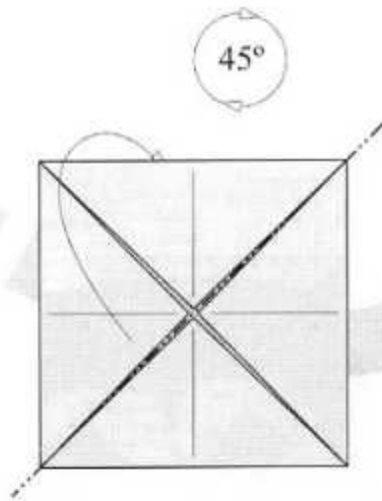
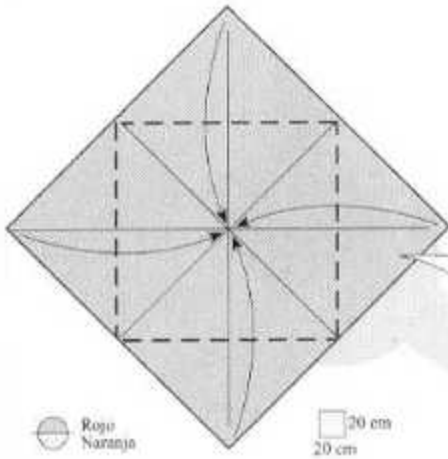
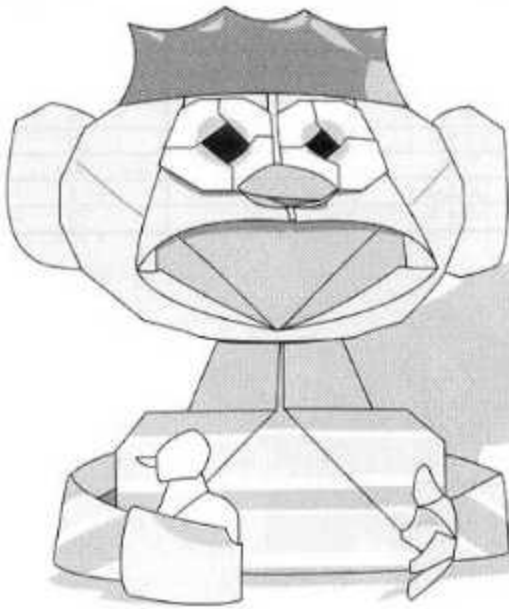

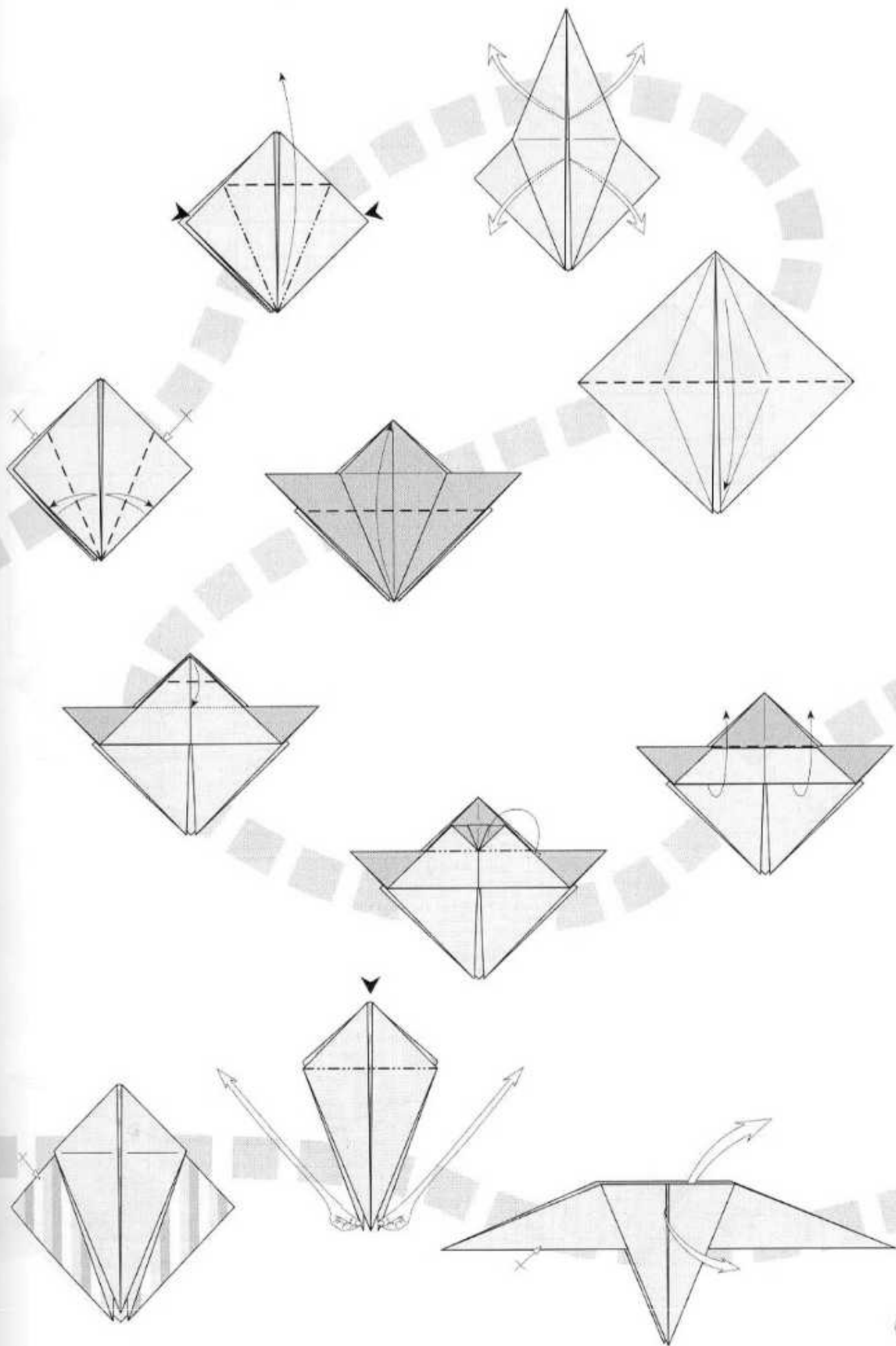

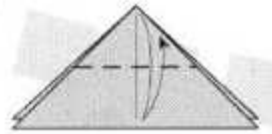
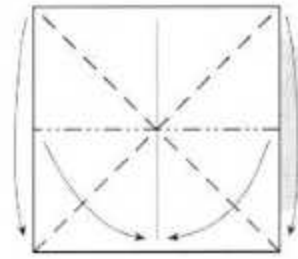
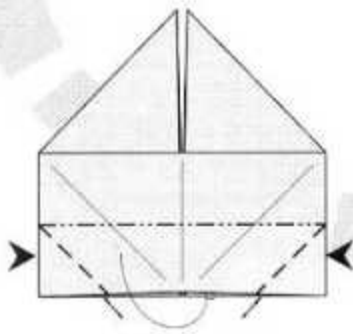
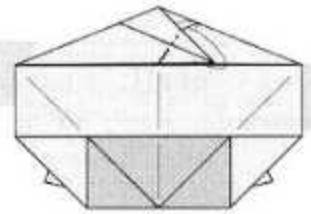
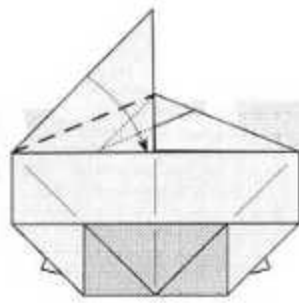
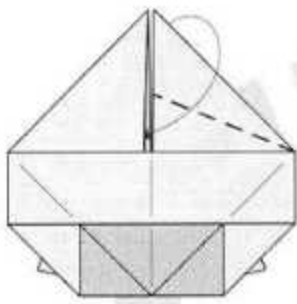

80°

5 cm

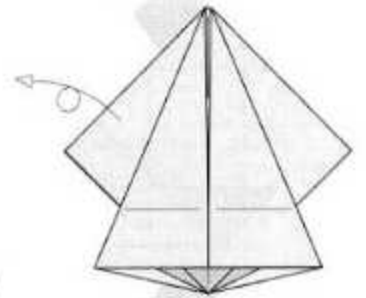
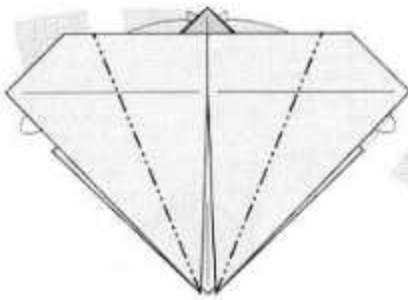
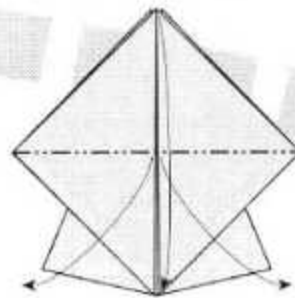

180°

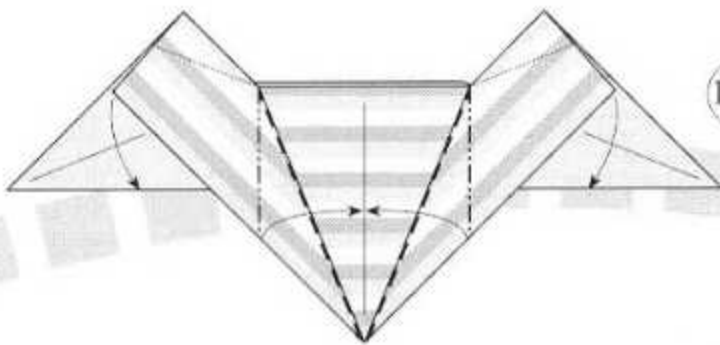
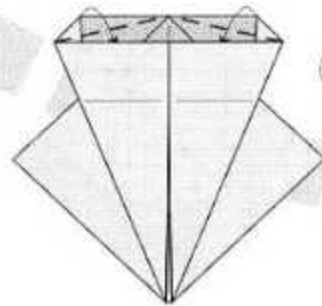

180°

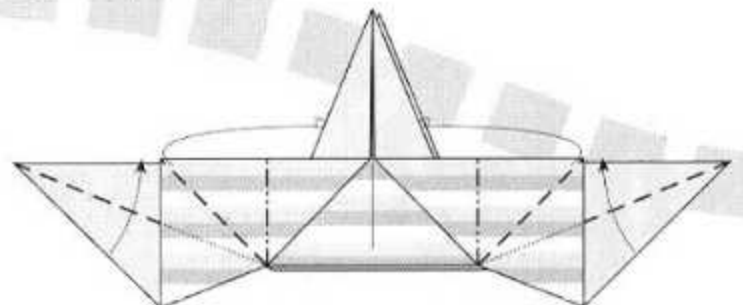

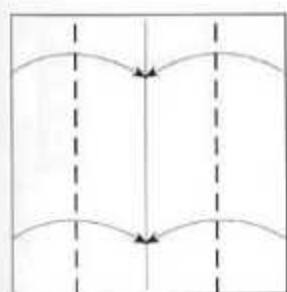
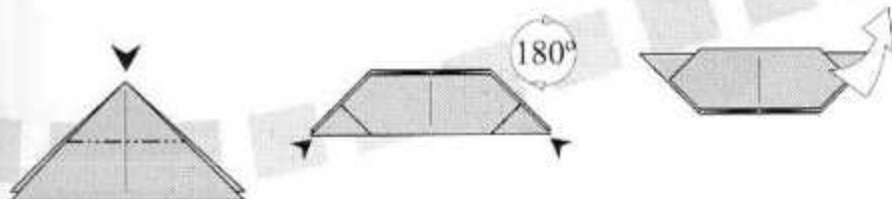
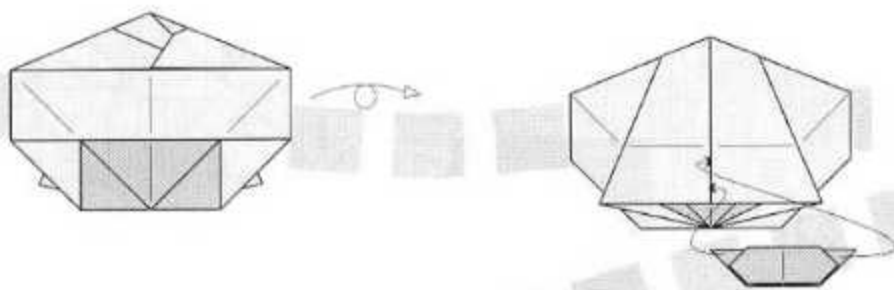

● Naranja 10 cm
□ 10 cm

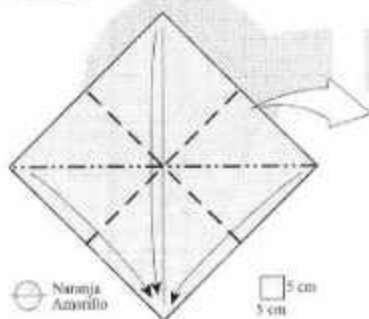
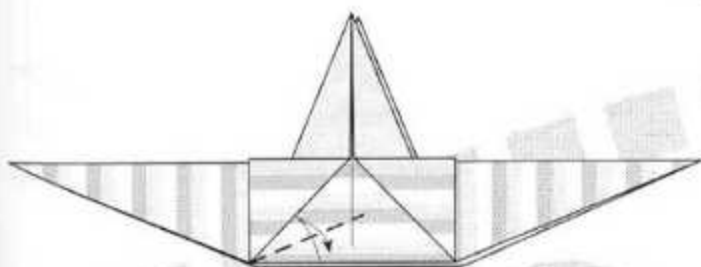
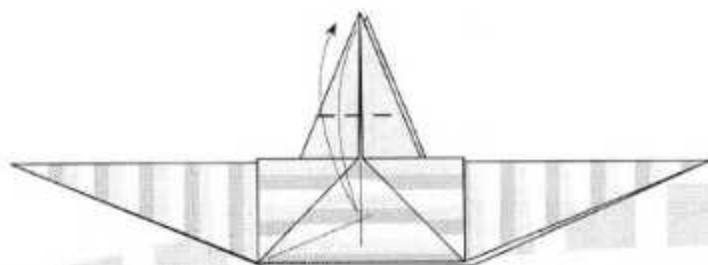
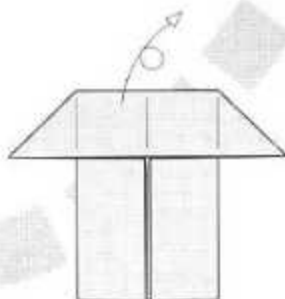
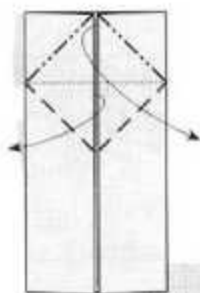
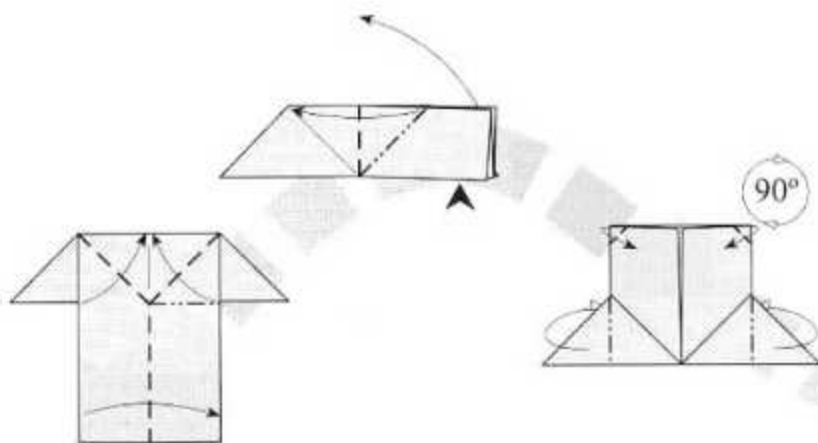

● Naranja
● Amarillo 5 cm
□ 5 cm

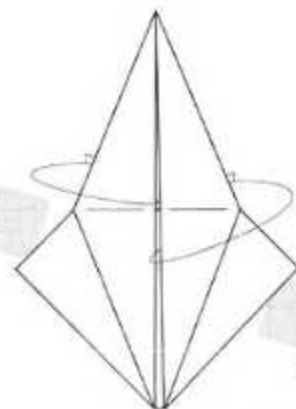
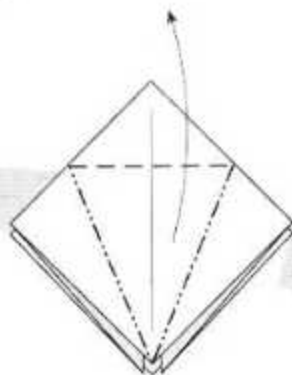

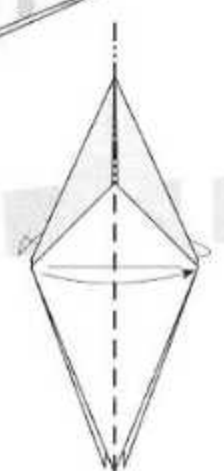
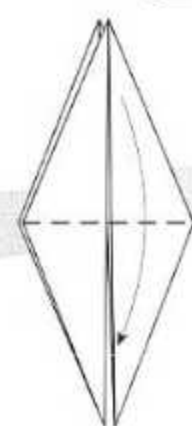
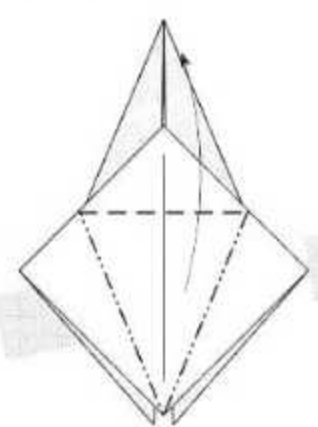
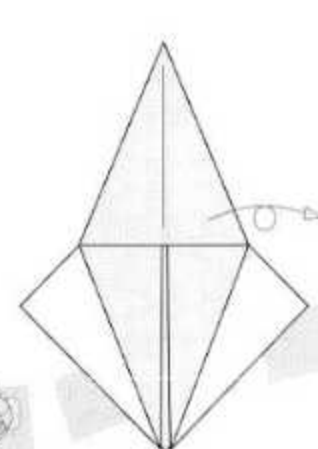
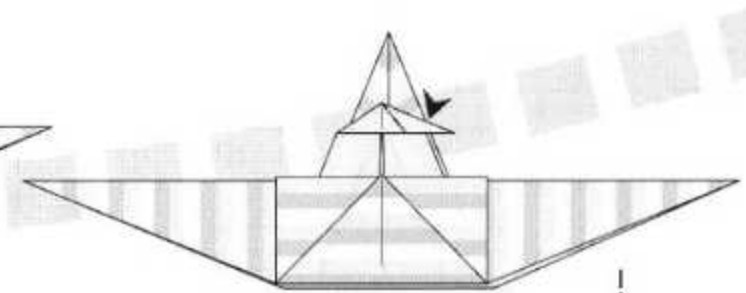
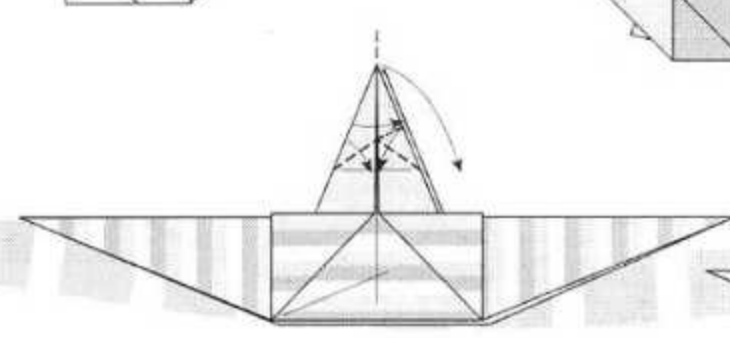
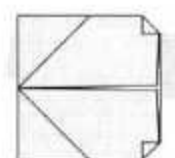
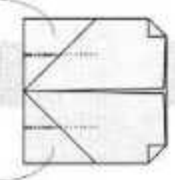
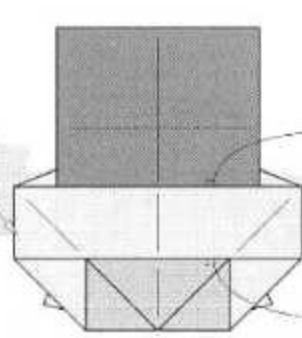
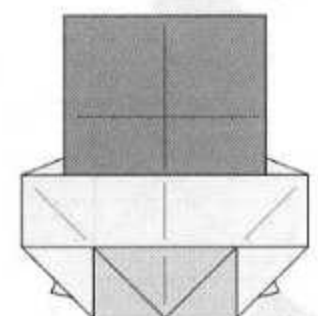
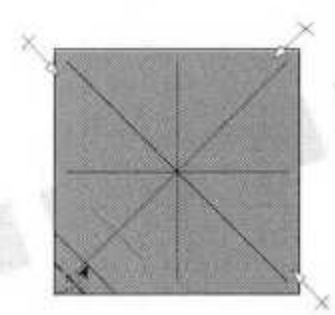
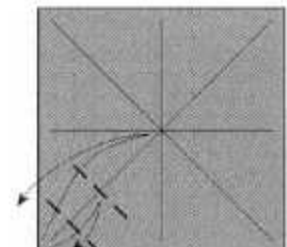
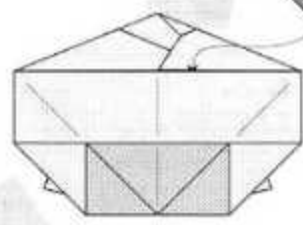
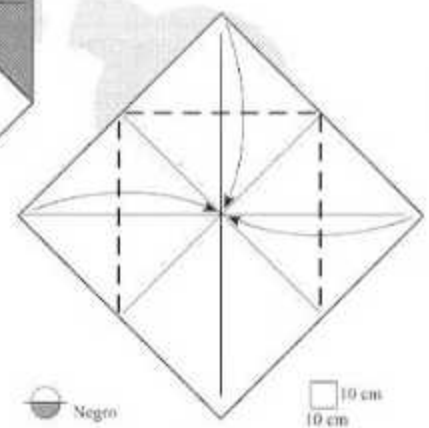
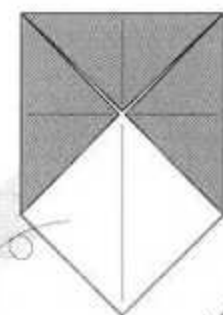
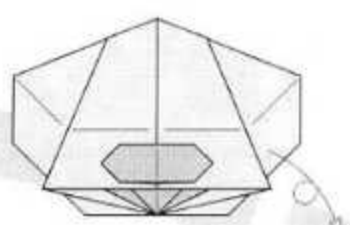

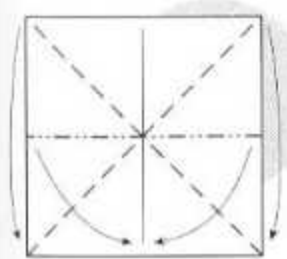
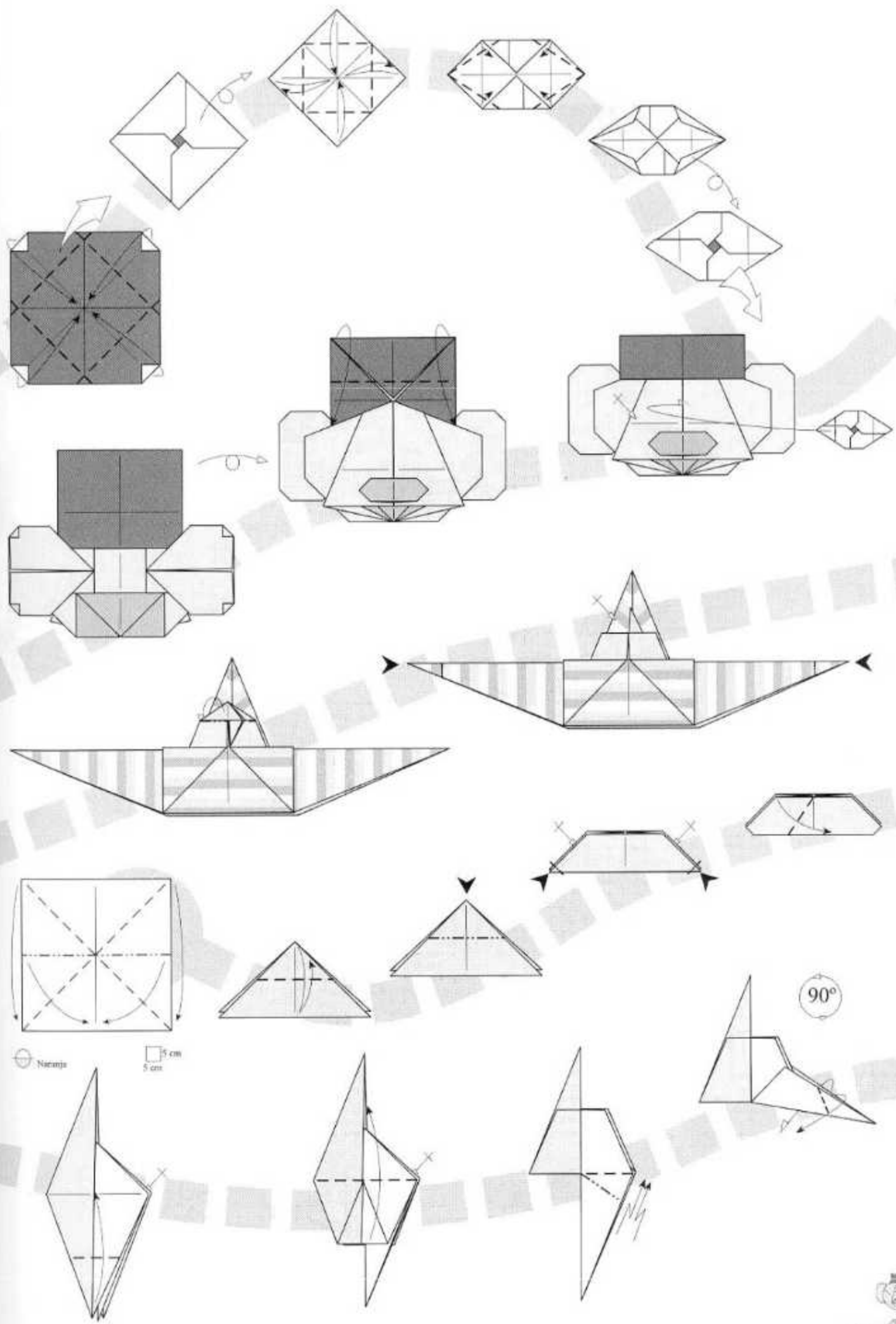

 *Nacimje*
  5 cm
  5 cm

90°



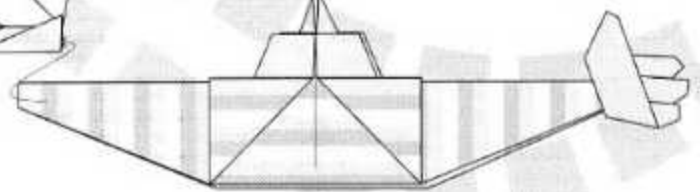
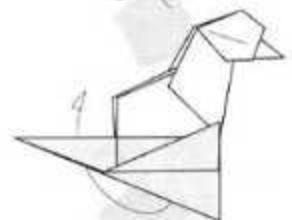
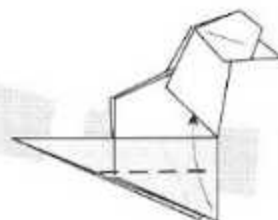
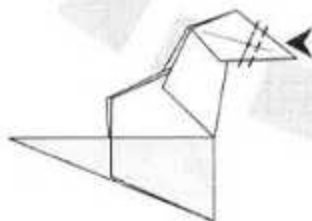
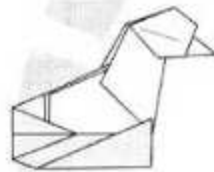
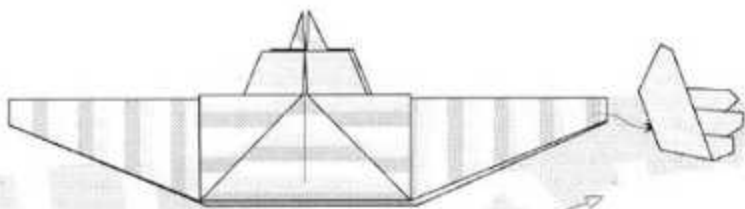
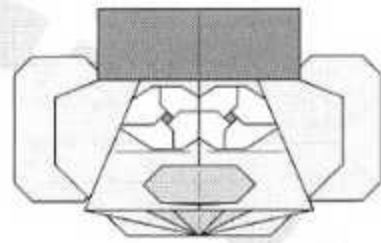
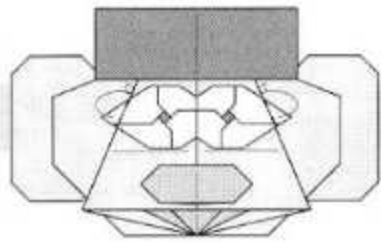

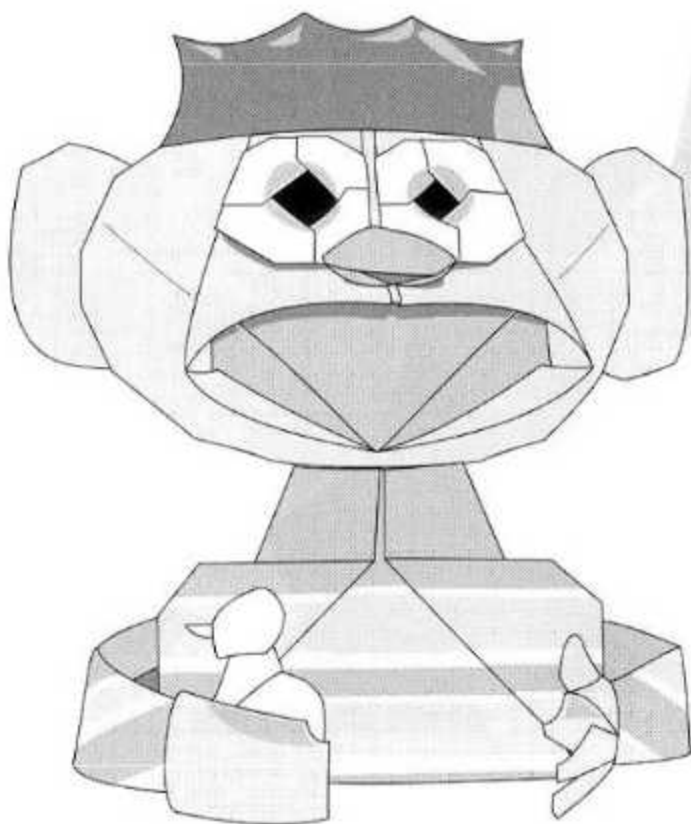
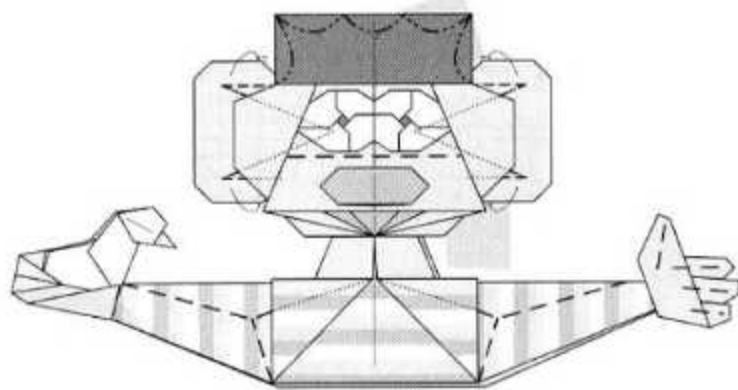
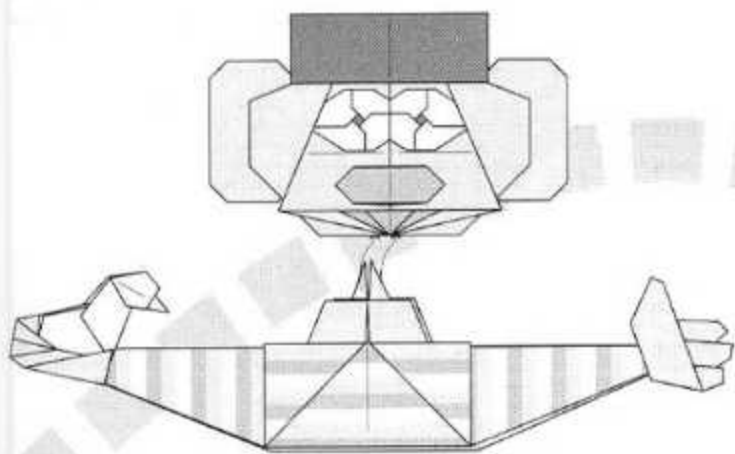

| Página (Desarr.) | Pieza nº | Cantidad | Porción | COLORES | | Tamaño original | Tamaño 3/10 | Tamaño 2/5 | Tamaño 3/5 |
|---------------------|----------|----------|---------------|---------|----------|-----------------|-------------|-------------|-------------|
| | | | | Anverso | Reverso | 15 * cm alto | 4,5 cm alto | 6 cm alto | 9 cm alto |
| | | | | | | Lado (cm) = | Lado (cm) = | Lado (cm) = | Lado (cm) = |
| 39 | 1 | 1 | Cara | Negro | Amarillo | 25 | 7,5 | 10 | 15 |
| 39 | 2 | 1 | Cejas | Neutro | Negro | 5 | 1,5 | 2 | 3 |
| 40 | 3 | 1 | Cuerpo-brazos | Rayas | Blanco | 25 | 7,5 | 10 | 15 |
| 40 | 4 | 1 | Ojos | Negro | Blanco | 5 | 1,5 | 2 | 3 |
| 41 | 5 | 1 | Nariz | Neutro | Rojo | 5 | 1,5 | 2 | 3 |
| 43 | 6 | 2 | Manos | Neutro | Amarillo | 5 | 1,5 | 2 | 3 |

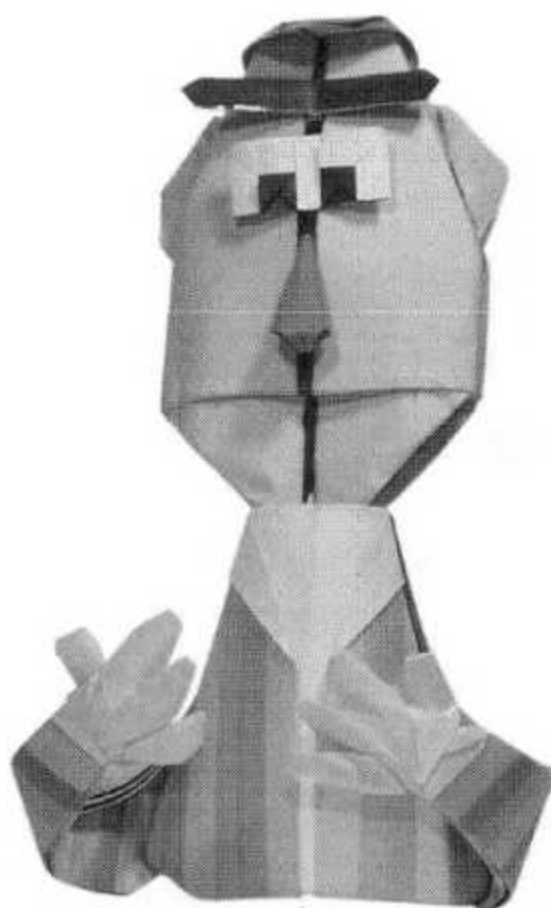

Plegado por: J.A.V.I.

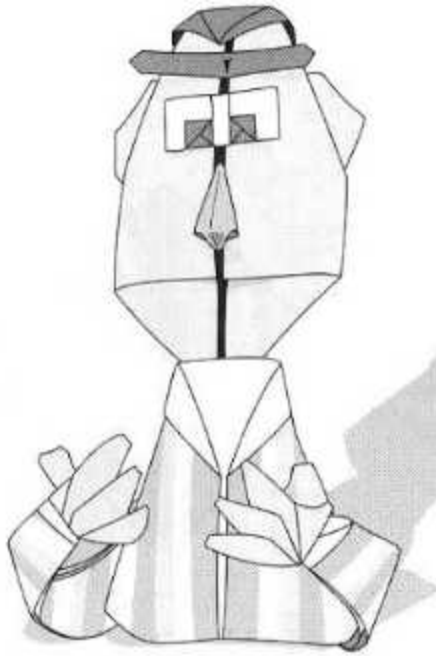

Utilizando las medidas recomendadas, se obtiene un modelo final de 15 cms.

| | |
|-----------------------------|------------|
| Autor: | Halle |
| Nivel de dificultad: | Medio-Bajo |
| Número de piezas: | 7 |
| Forma de las piezas: | Cuadrados |

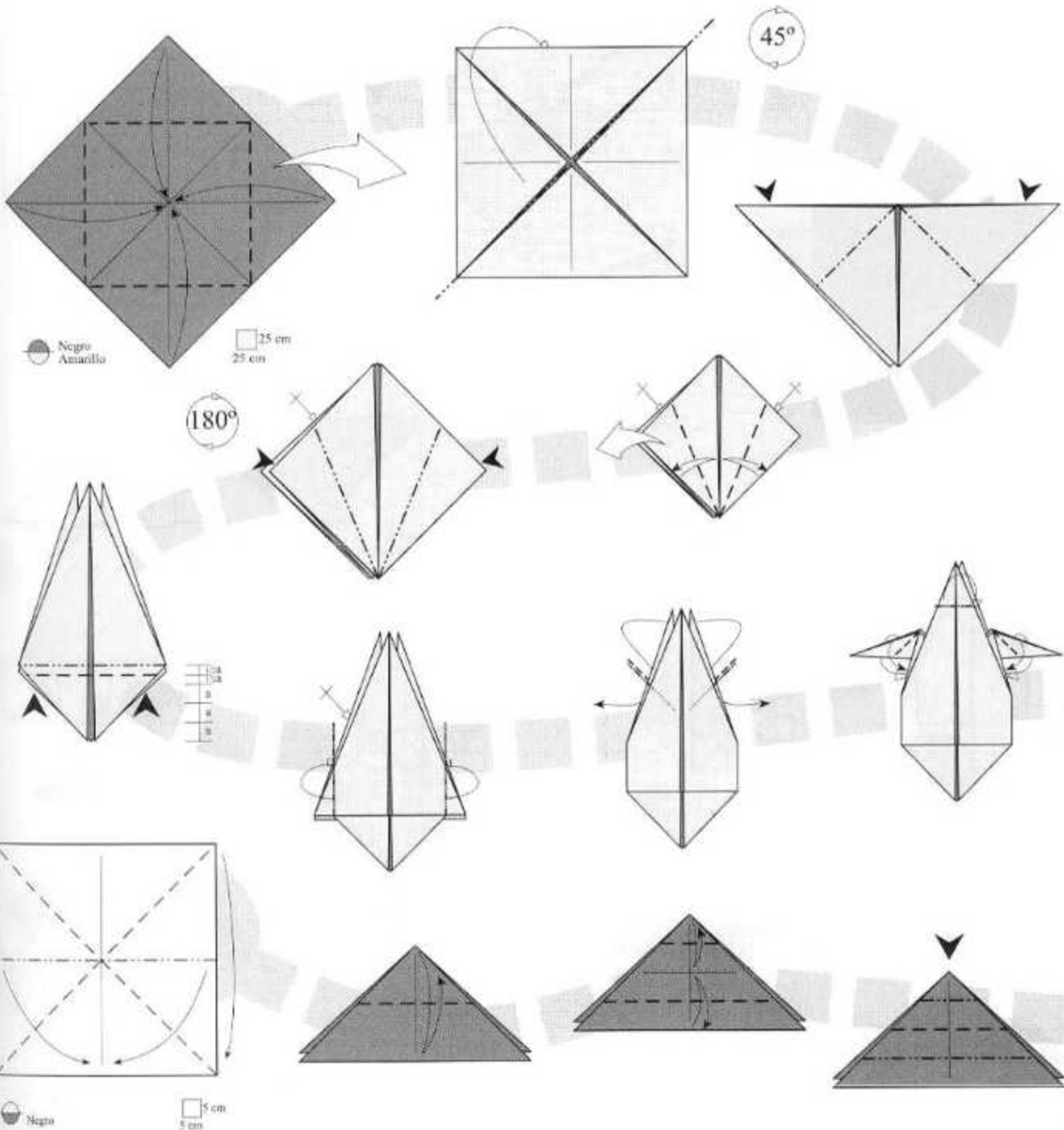

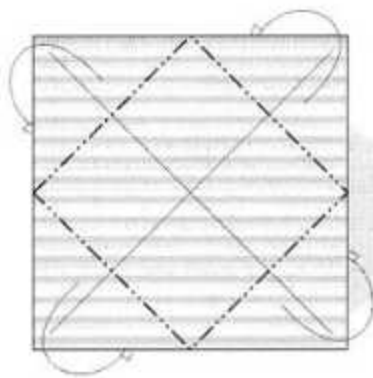

Rayos
Blanco

25 cm
25 cm

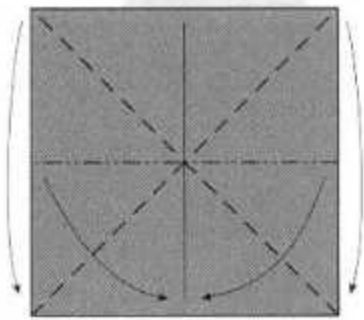
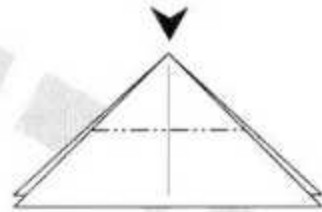
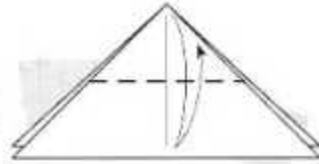
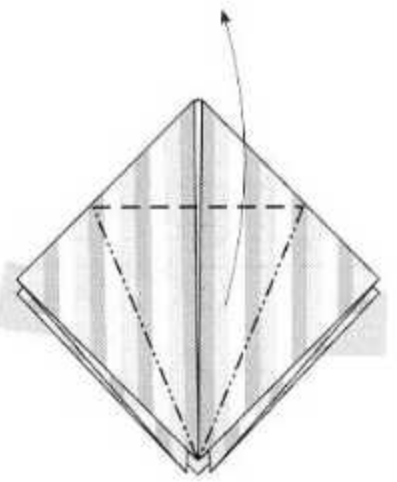
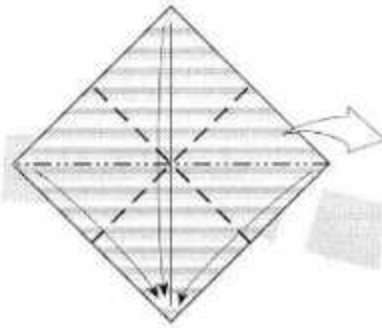

Negro
Blanco

5 cm
5 cm

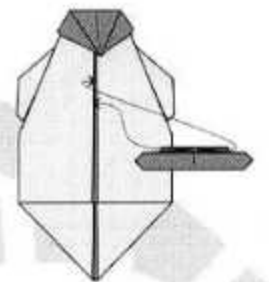
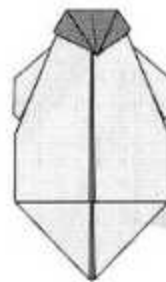
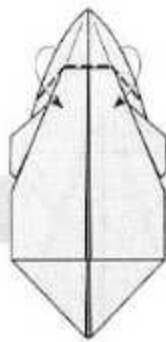
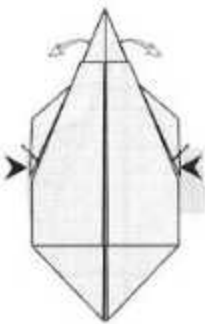
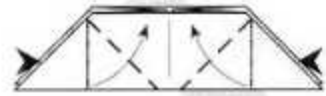

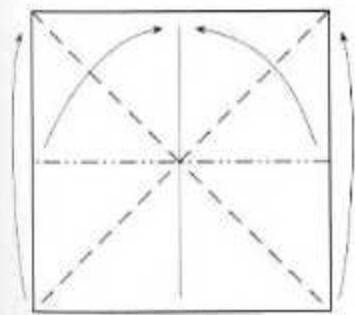
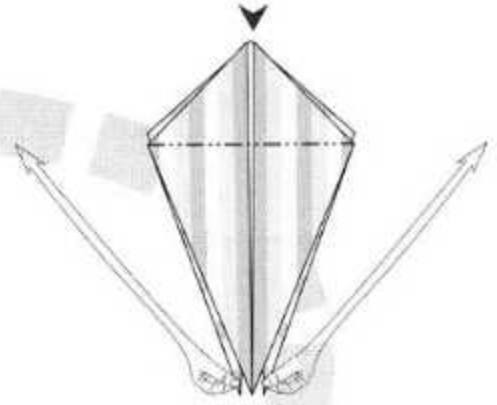
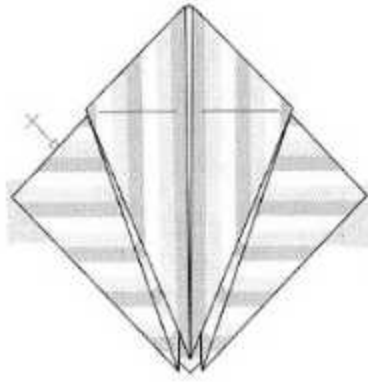
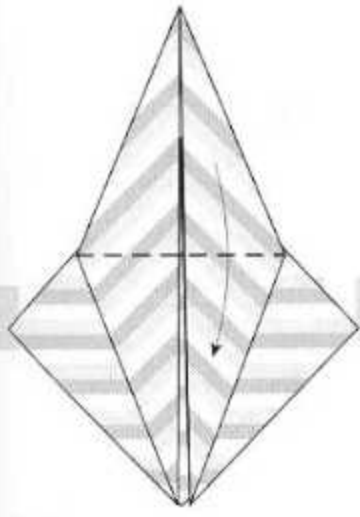

Recorta

5 cm
5 cm

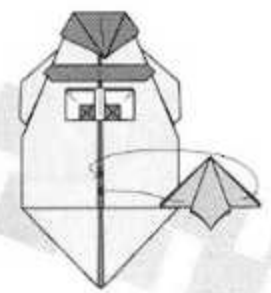
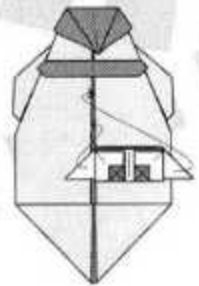
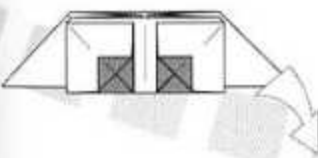
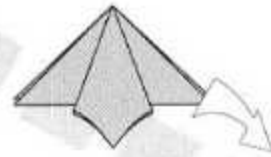
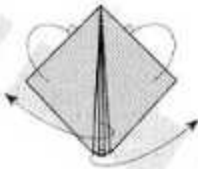
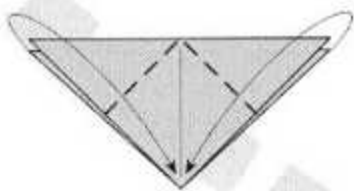
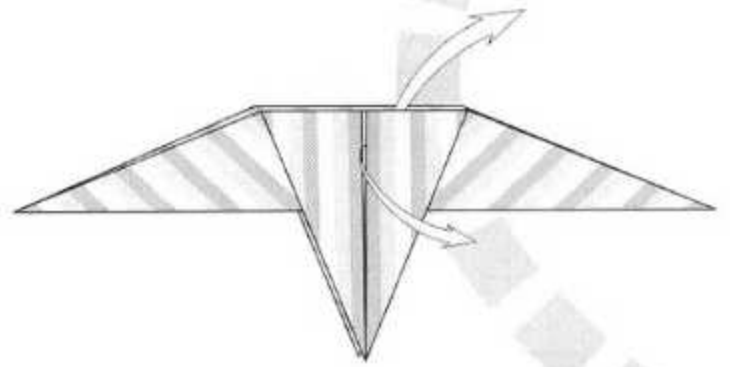

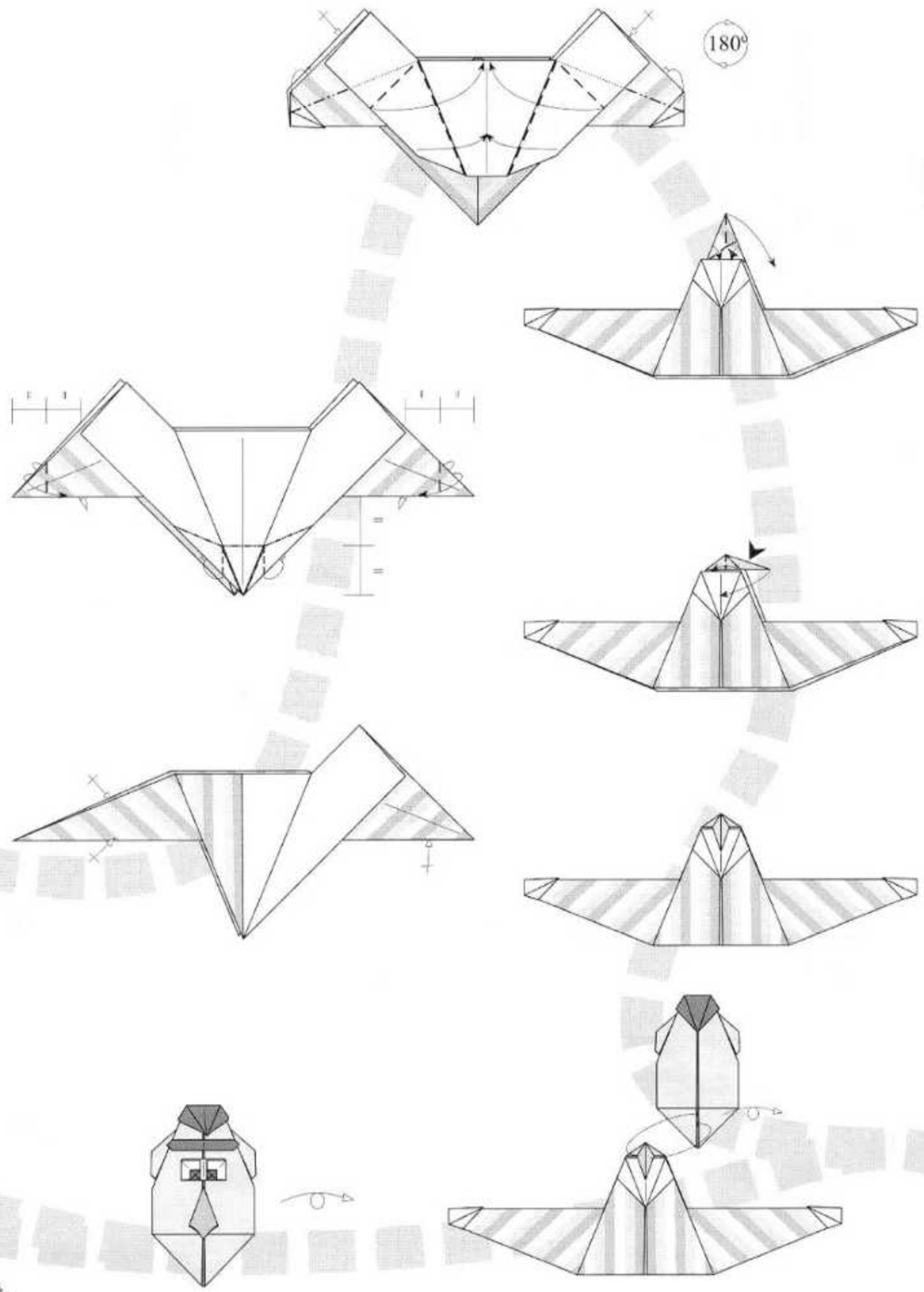

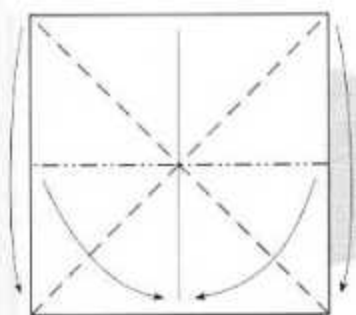

⊖ Amarelo

□ 6 cm
5 cm

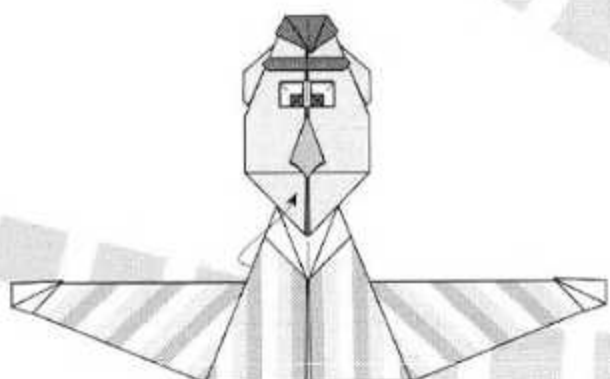
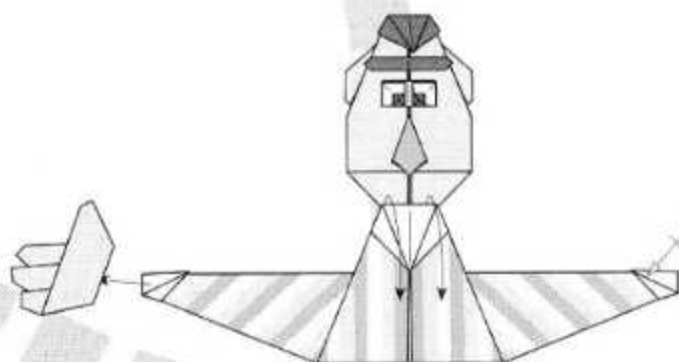
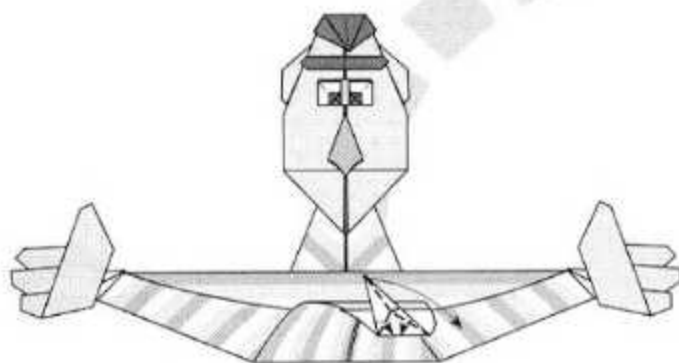
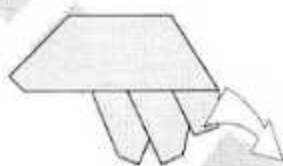
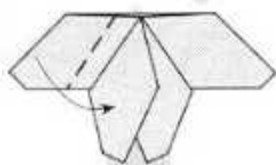
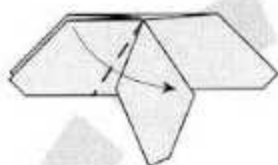
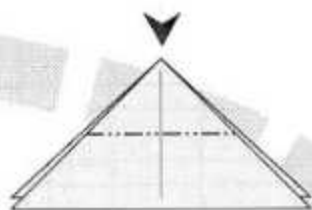
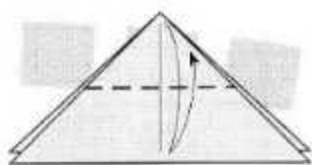

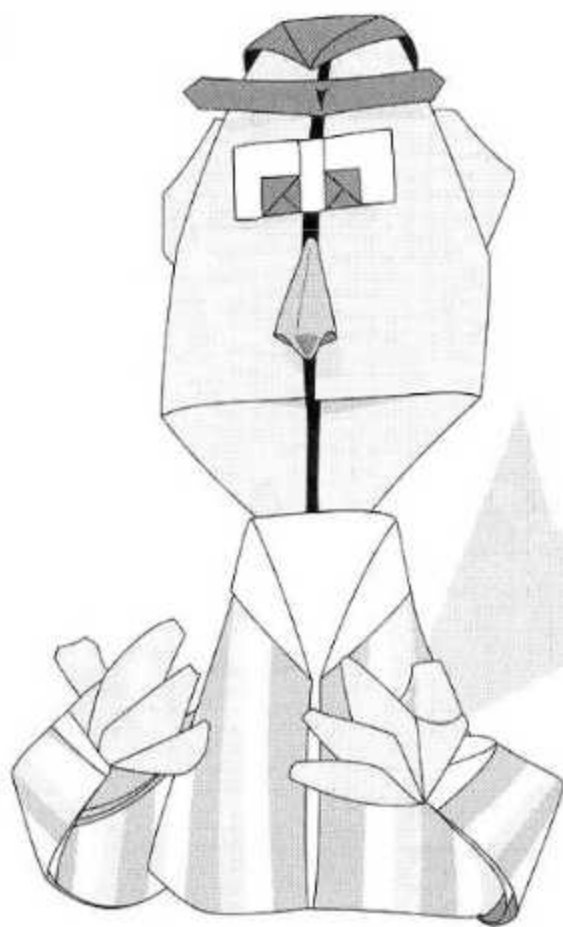
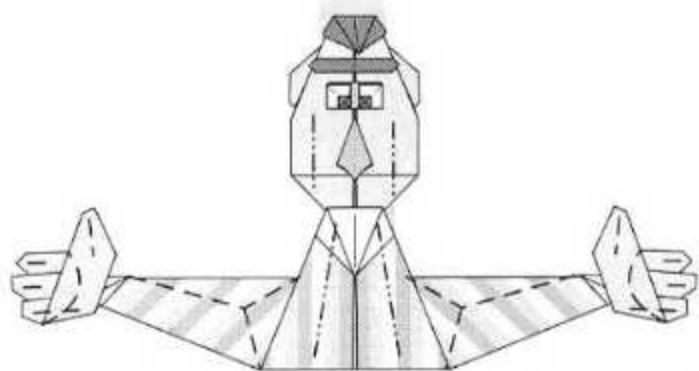
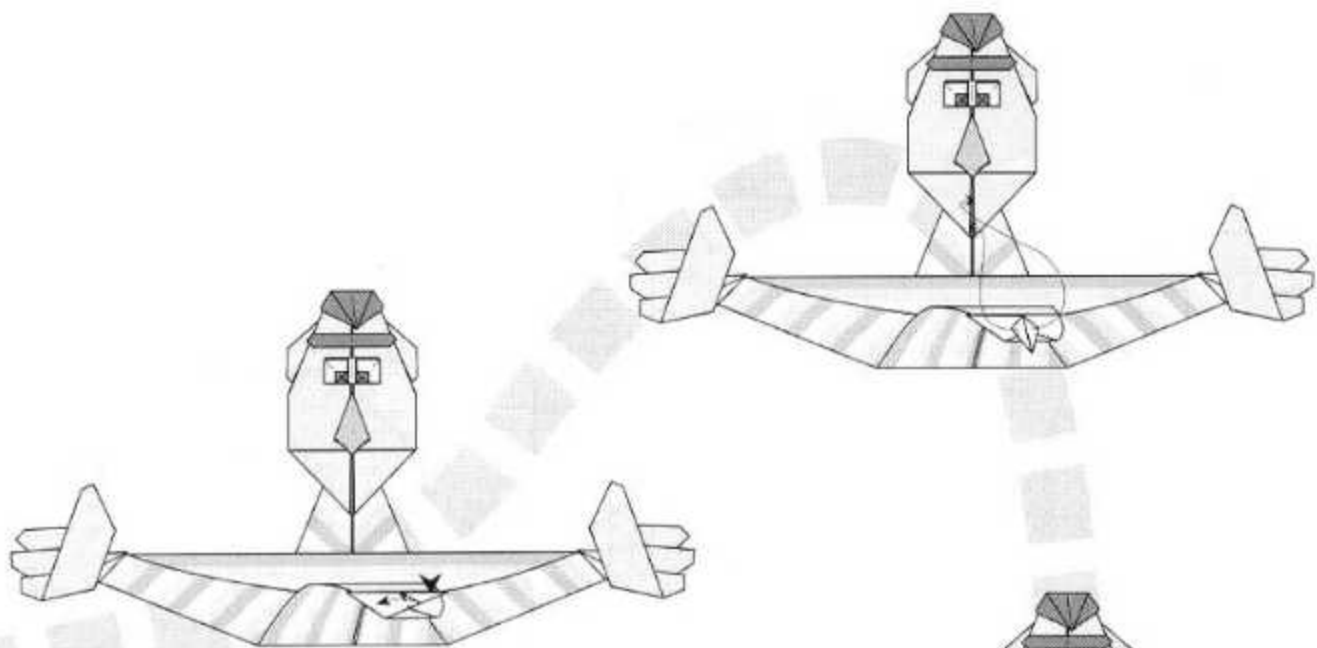

| Página | Pieza nº | Cantidad | Porción | COLORES | | Tamaño original | Tamaño 2/5 | Tamaño 3/5 | Tamaño 4/5 |
|--------|----------|----------|-----------|---------|---------|-----------------|-------------|--------------|--------------|
| | | | | Anverso | Reverso | 18 cm alto | 7,2 cm alto | 10,8 cm alto | 14,4 cm alto |
| | | | | | | Lado (cm) = | Lado (cm) = | Lado (cm) = | Lado (cm) = |
| 46 | 1 | 2 | Trabillas | Blanco | Gris | 5 | 2 | 3 | 4 |
| 46 | 2 | 1 | Cuerpo | Neutro | Gris | 20 | 8 | 12 | 16 |
| 46 | 3 | 1 | Piernas | Neutro | Azul | 5 | 2 | 3 | 4 |
| 47 | 4 | 1 | Brazos | Marrón | Gris | 20 | 8 | 12 | 16 |
| 49 | 5 | 1 | Base cara | Neutro | Rosa | 15 | 6 | 9 | 12 |
| 49 | 6 | 1 | Nariz | Neutro | Rosa | 5 | 2 | 3 | 4 |
| 49 | 7 | 1 | Ojos | Negro | Bianco | 5 | 2 | 3 | 4 |
| 51 | 8 | 1 | Pelos | Neutro | Negro | 10 | 4 | 6 | 8 |
| 51 | 9 | 1 | Mástil | Neutro | Azul | 10 | 4 | 6 | 8 |
| 51 | 10 | 1 | Manerales | Marrón | Gris | 15 | 6 | 9 | 12 |
| 53 | 11 | 1 | Rotor | Azul | Bianco | 15 | 6 | 9 | 12 |



Plegado por: J.A.V.I.

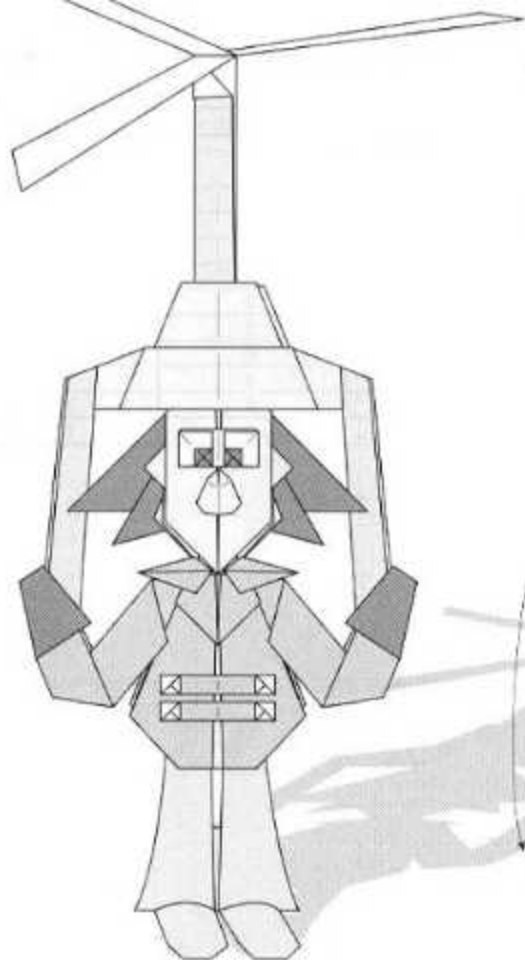

Utilizando las medidas recomendadas, se obtiene un modelo final de 18 cms.

| | |
|-----------------------------|-----------|
| Autor: | Halle |
| Nivel de dificultad: | Medio |
| Número de piezas: | 12 |
| Forma de las piezas: | Cuadrados |

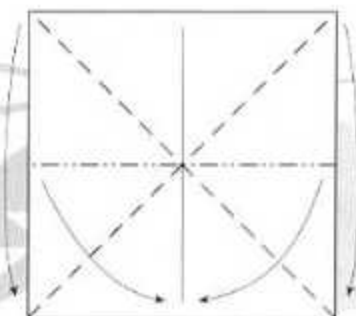

Blanco
Gris

5 cm
5 cm

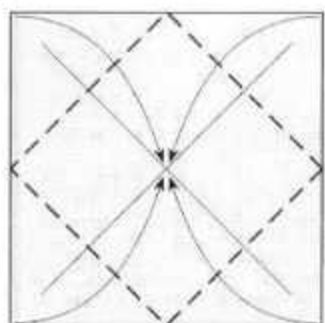
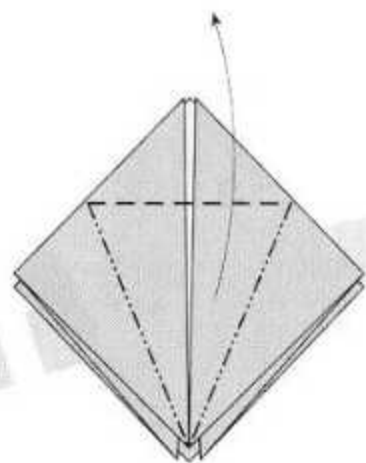
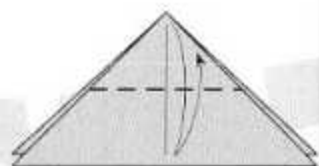

Gris

20 cm
20 cm

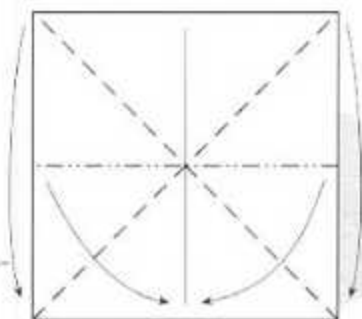
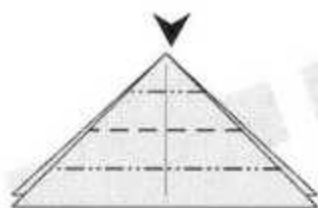
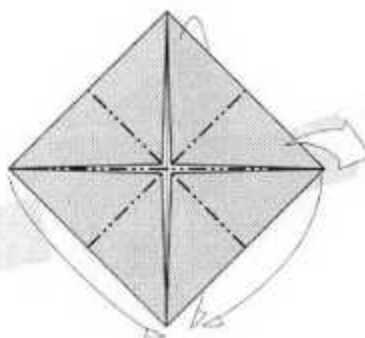

Azul

5 cm
5 cm

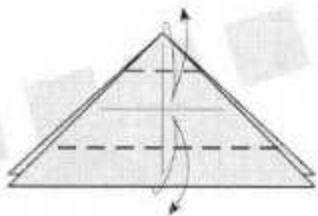
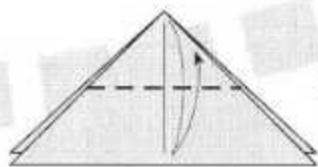

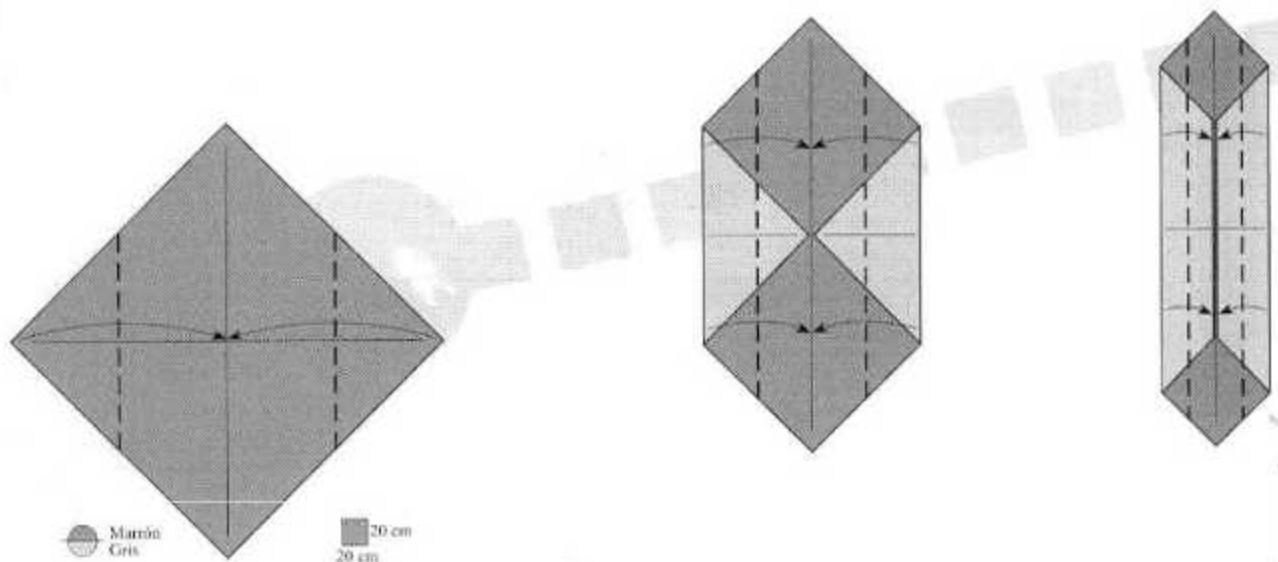
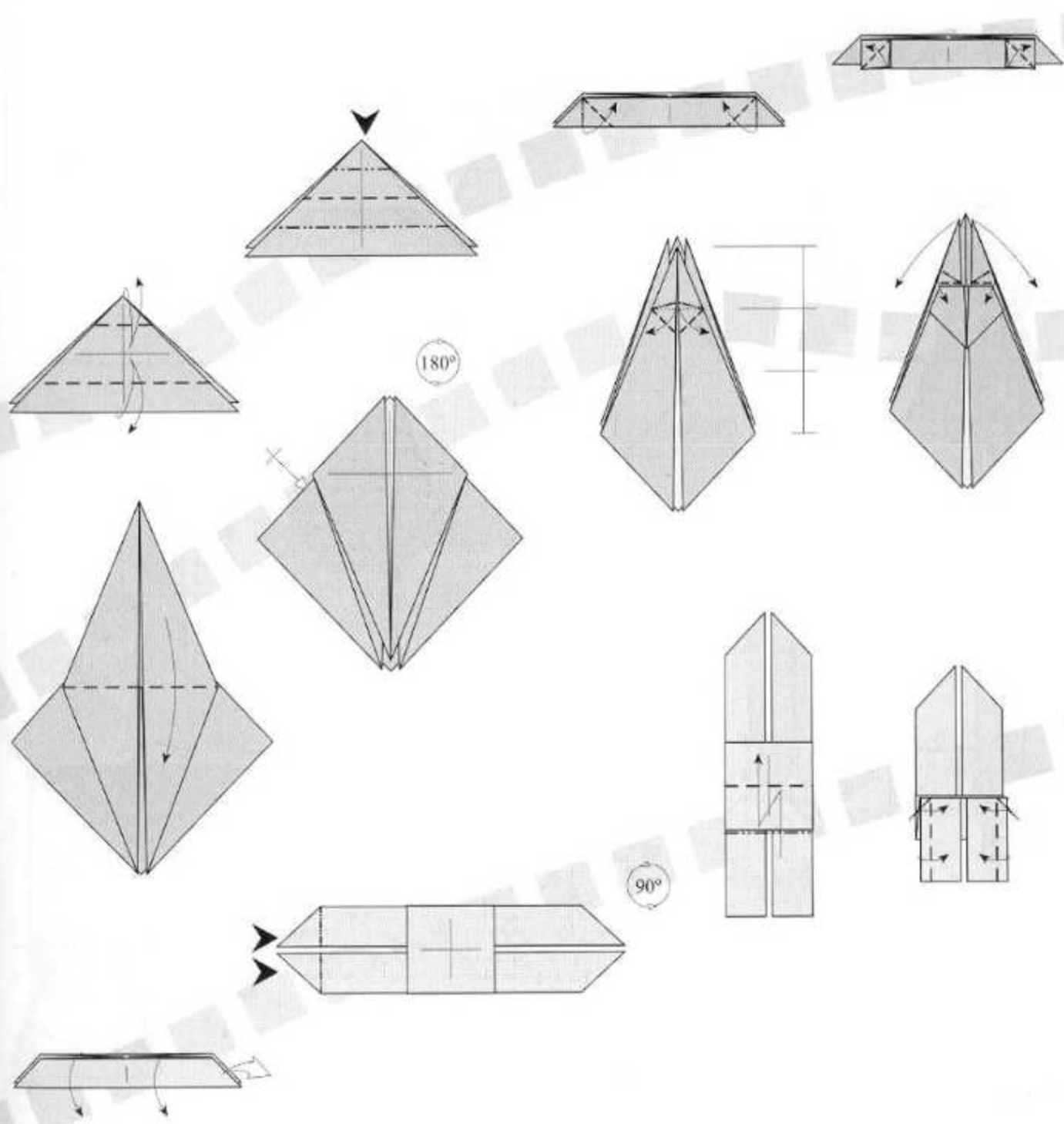

● Marrón
● Gris

■ 20 cm
■ 20 cm



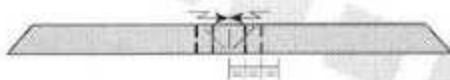
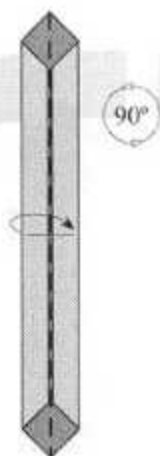
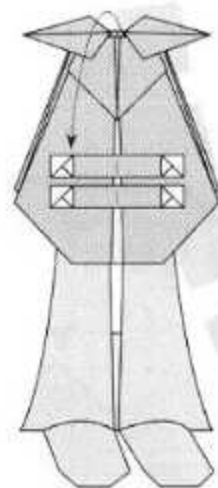
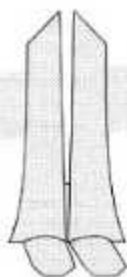
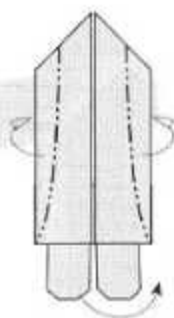
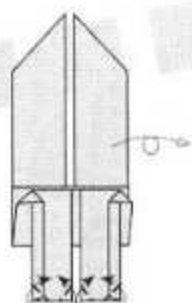
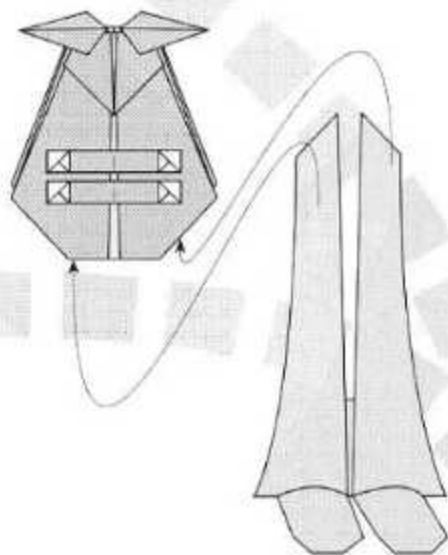
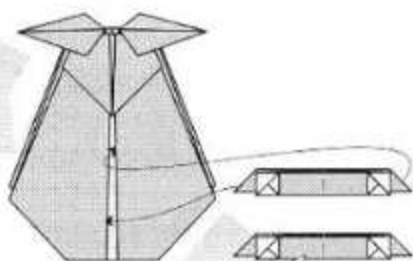
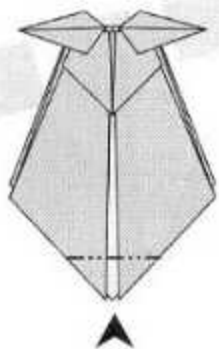
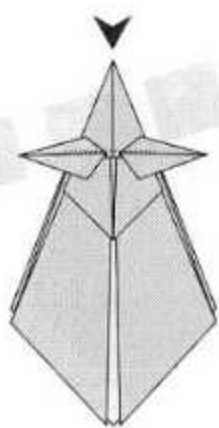

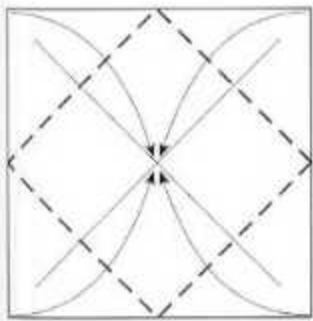

Rosa

15 cm
15 cm

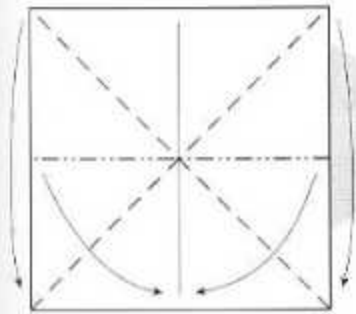
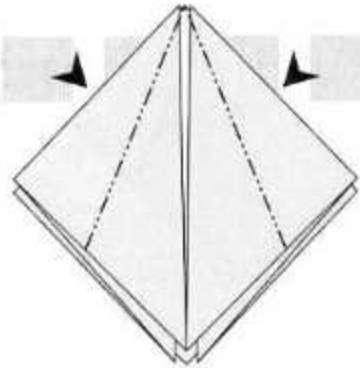
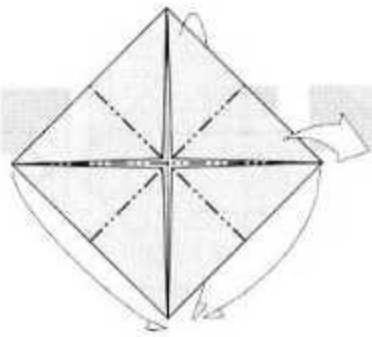

Rosa

7 cm
5 cm

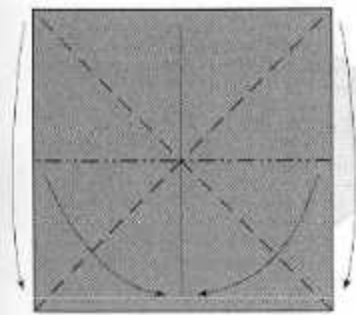
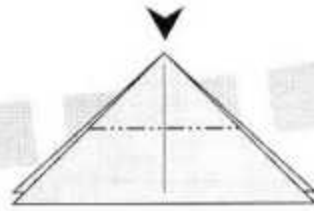
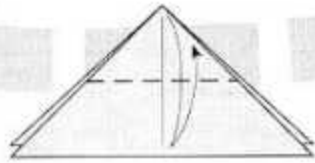

Mariposa Negra

5 cm
5 cm

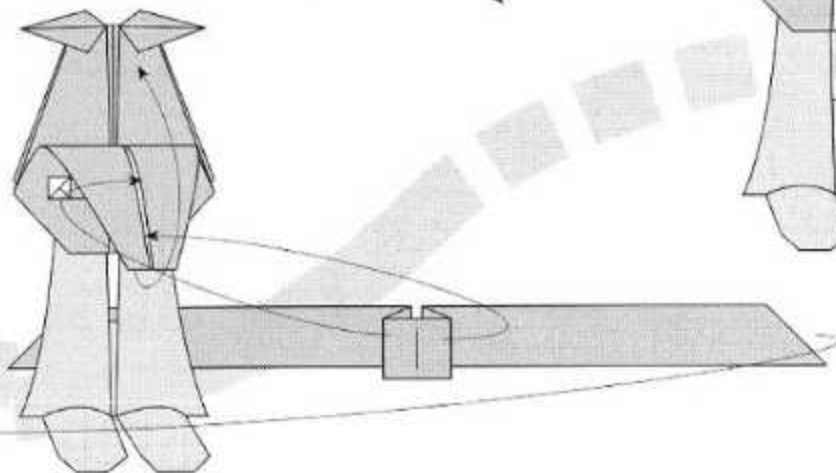
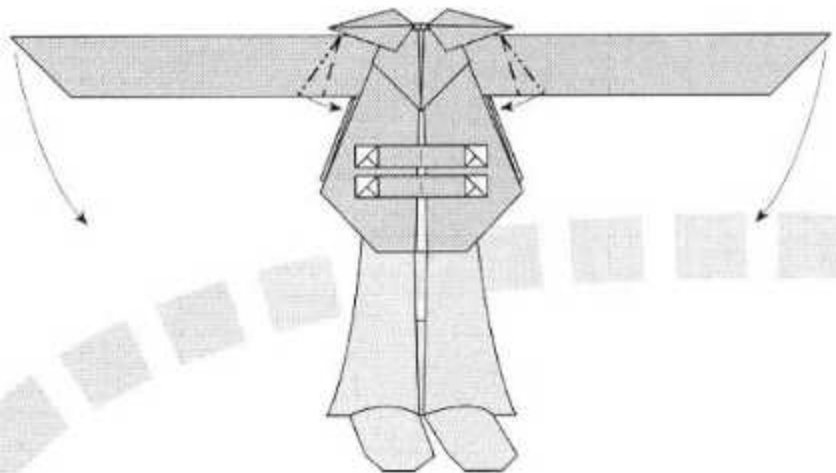
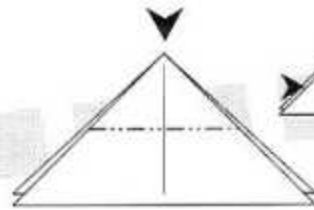
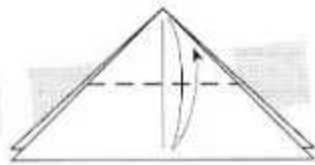

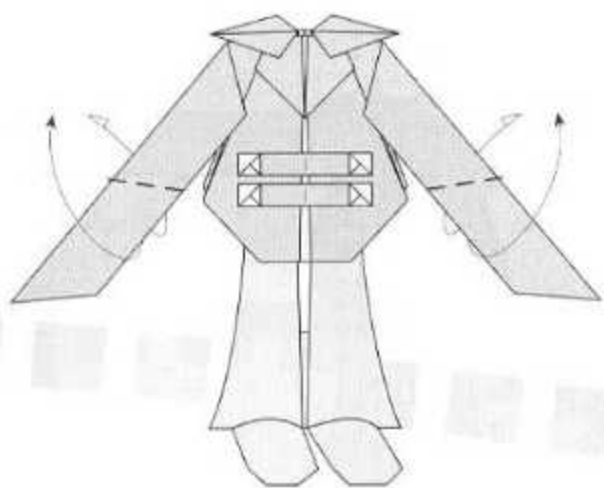
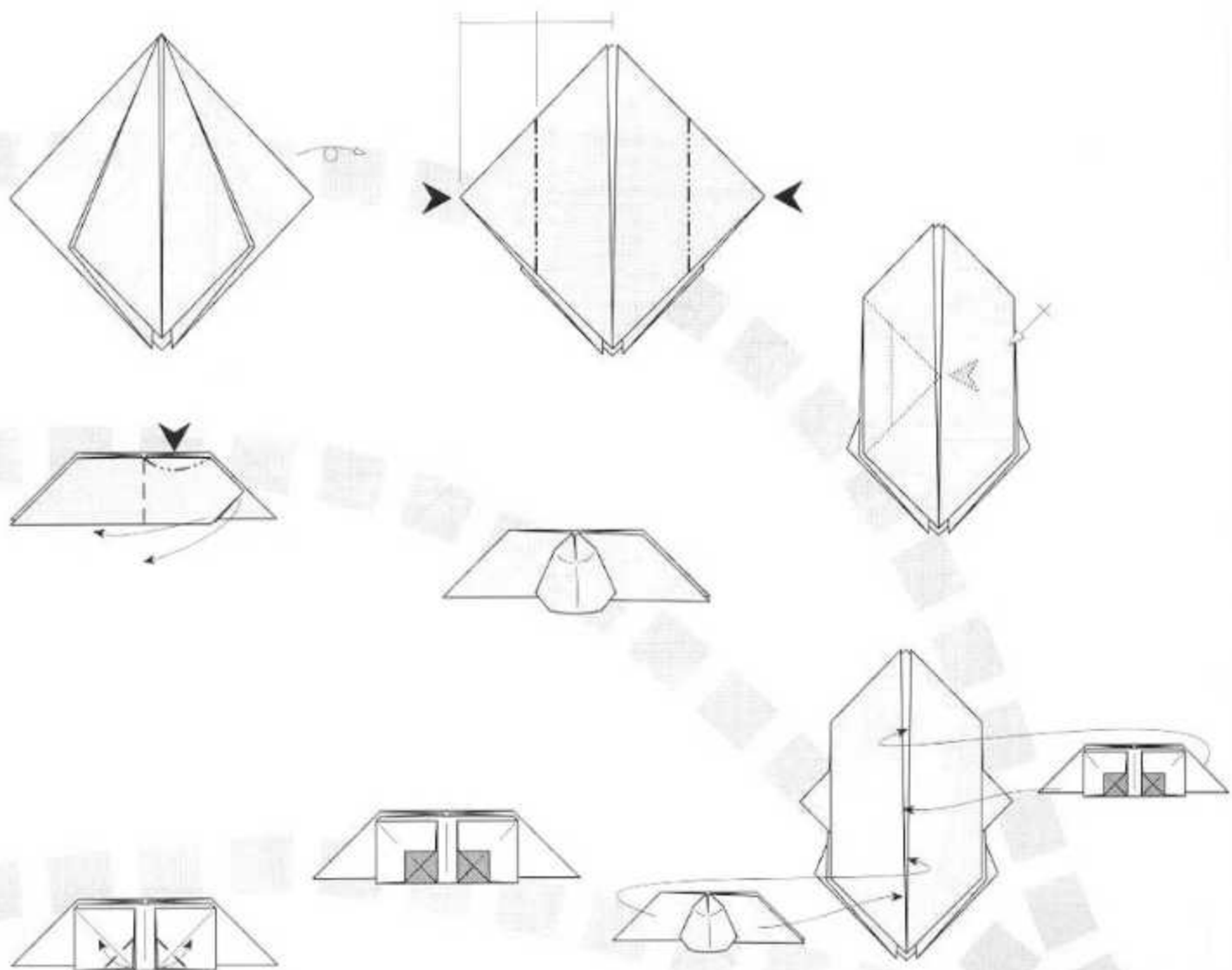

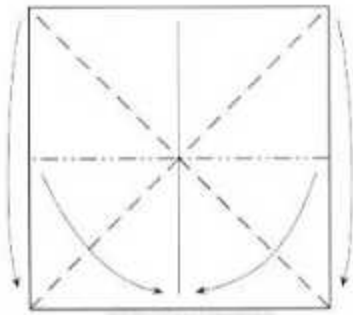

● Negro

10 cm
10 cm

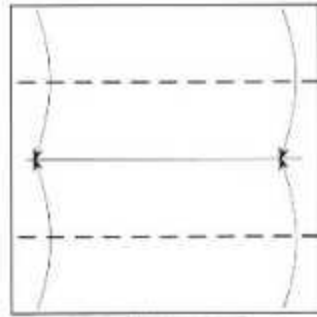

● Azul

10 cm
10 cm

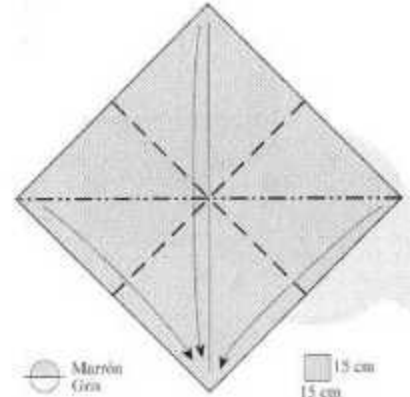

● Marrón
● Verde

15 cm
15 cm

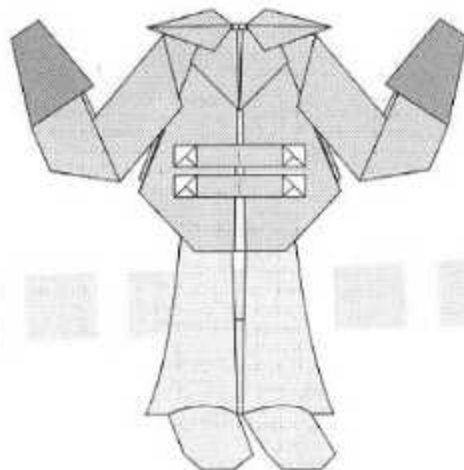
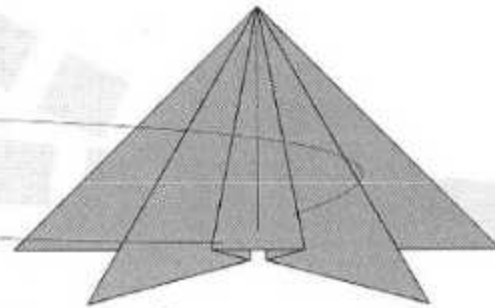
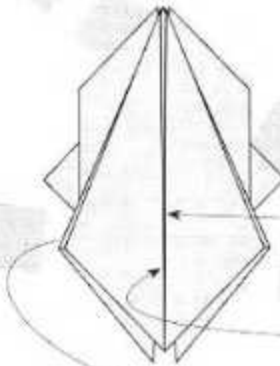
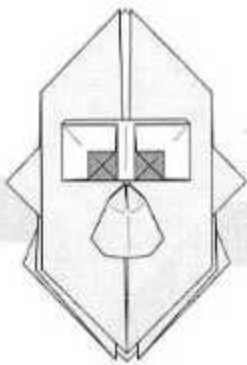
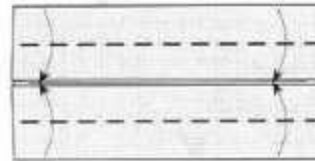

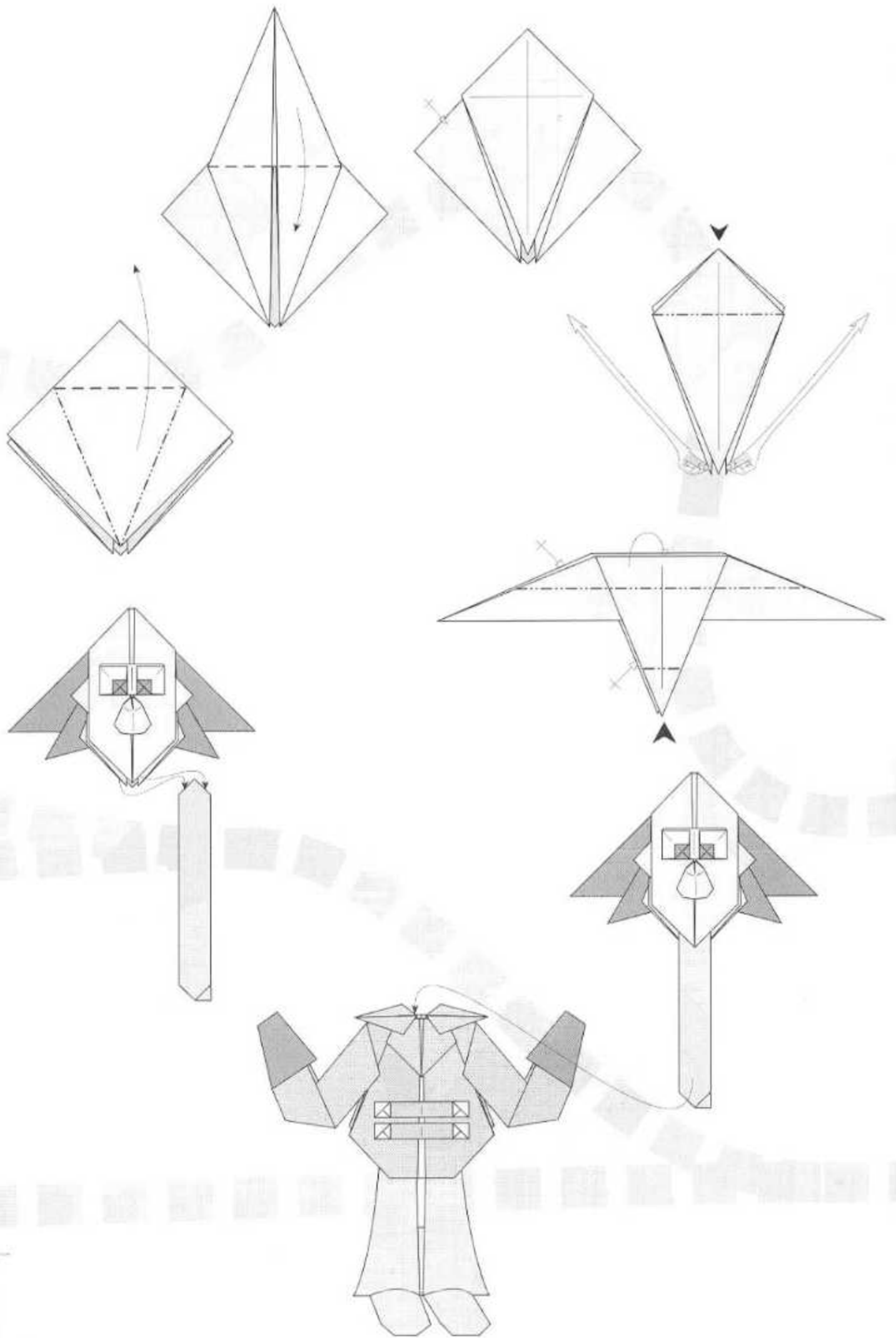

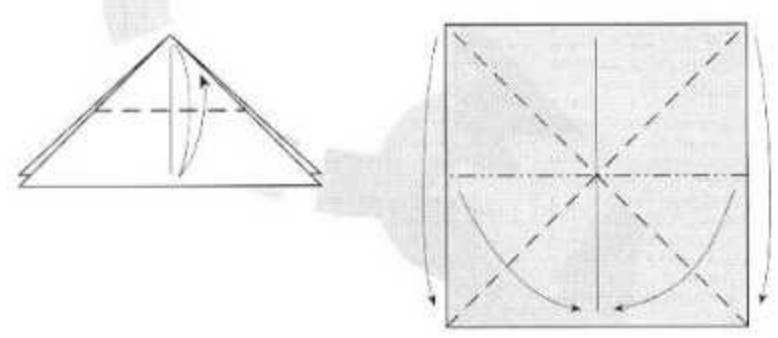
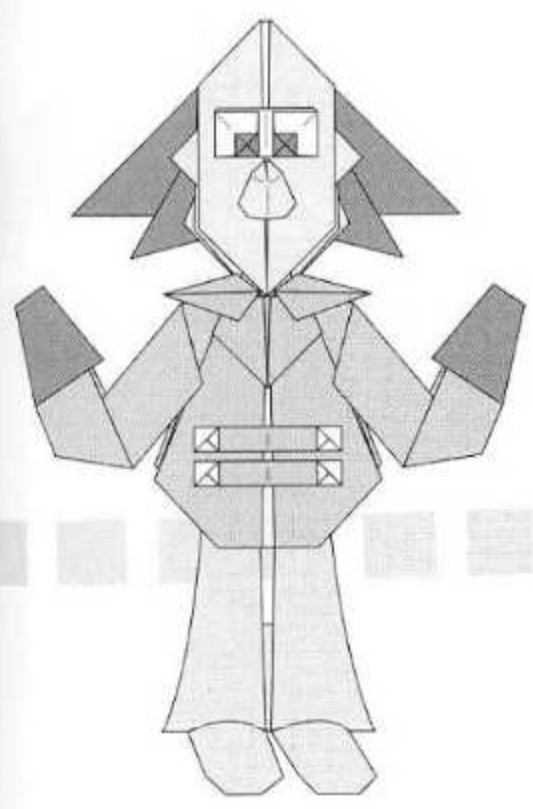
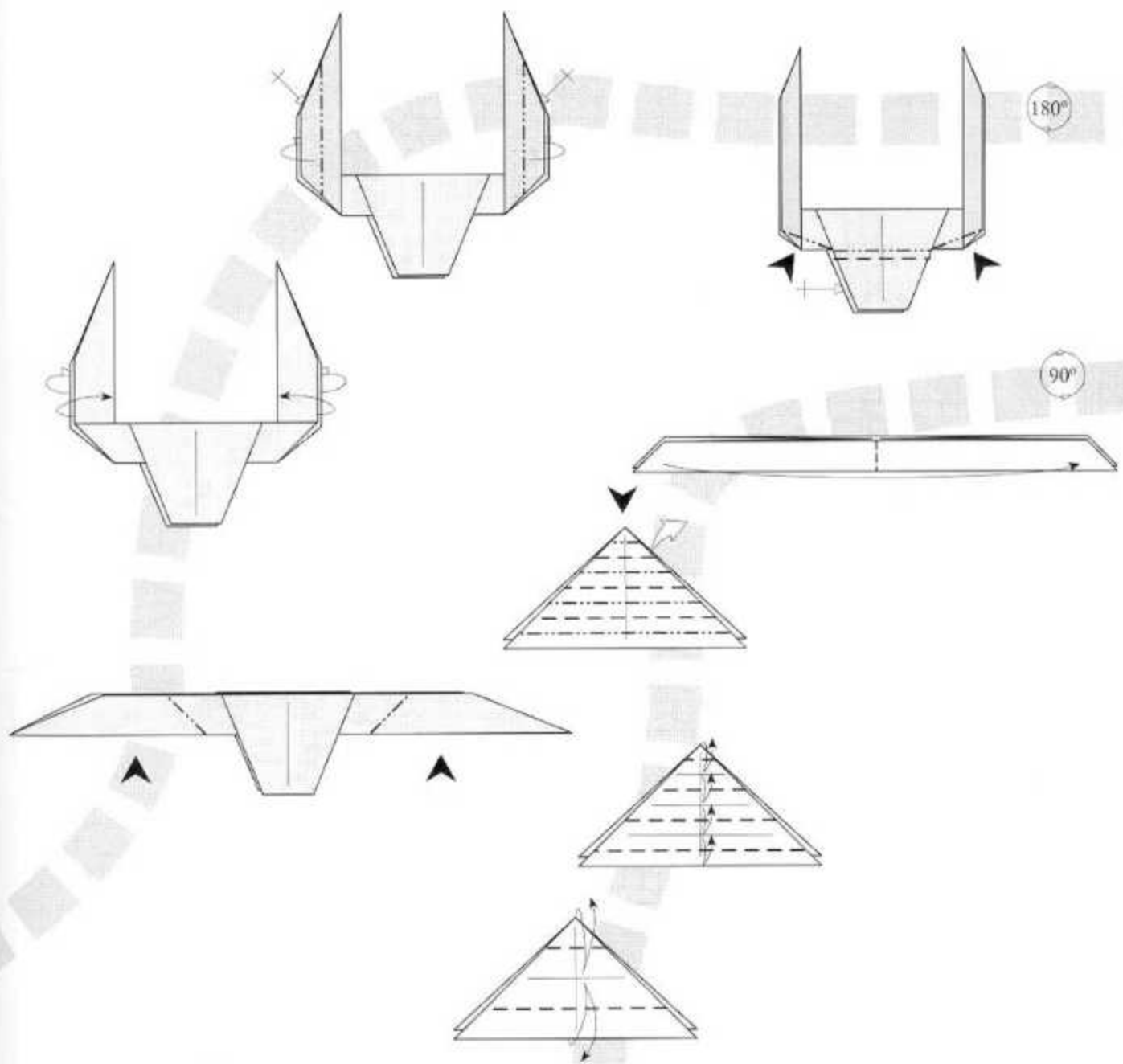

 Azul
 Blanco

 11 cm
 13 cm



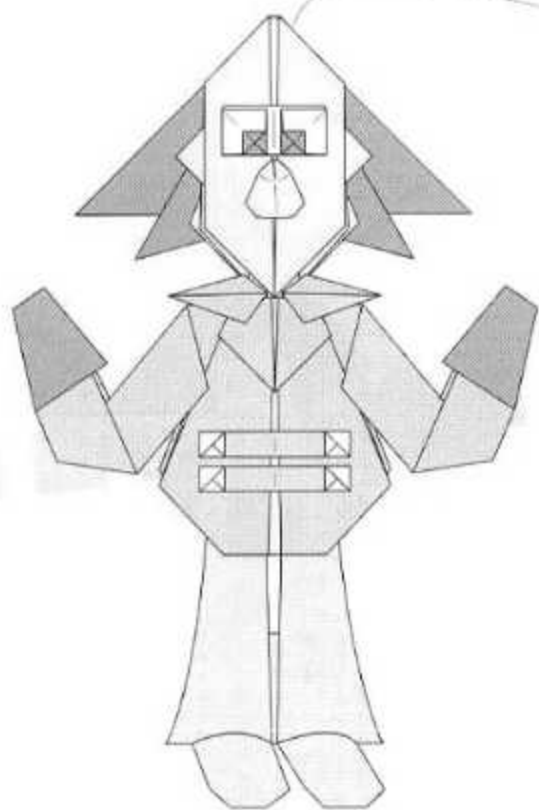
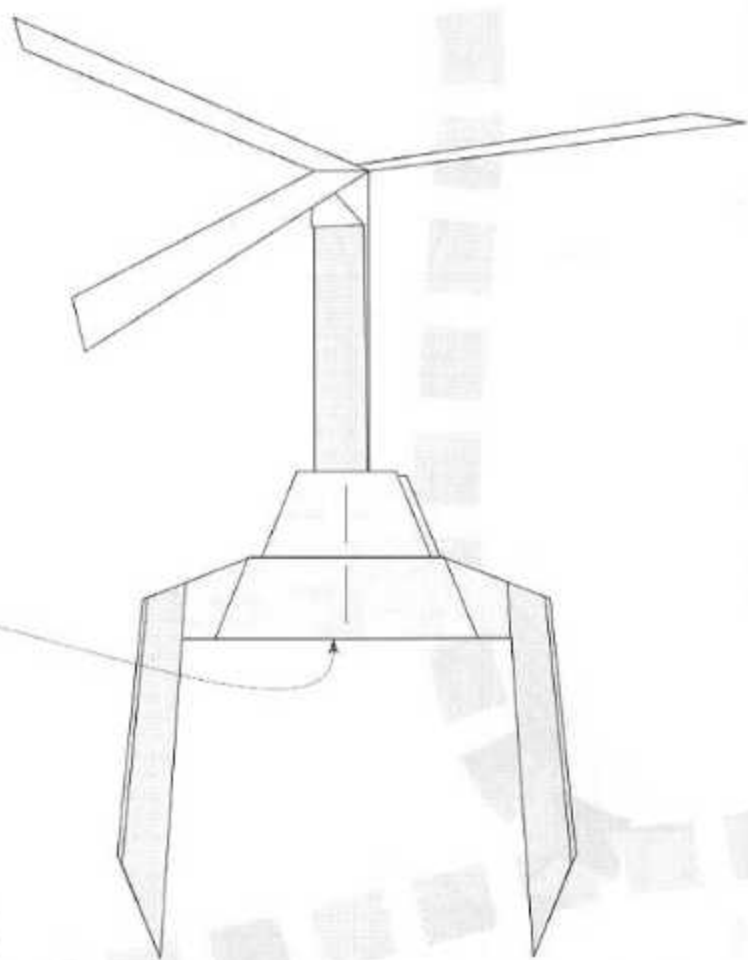
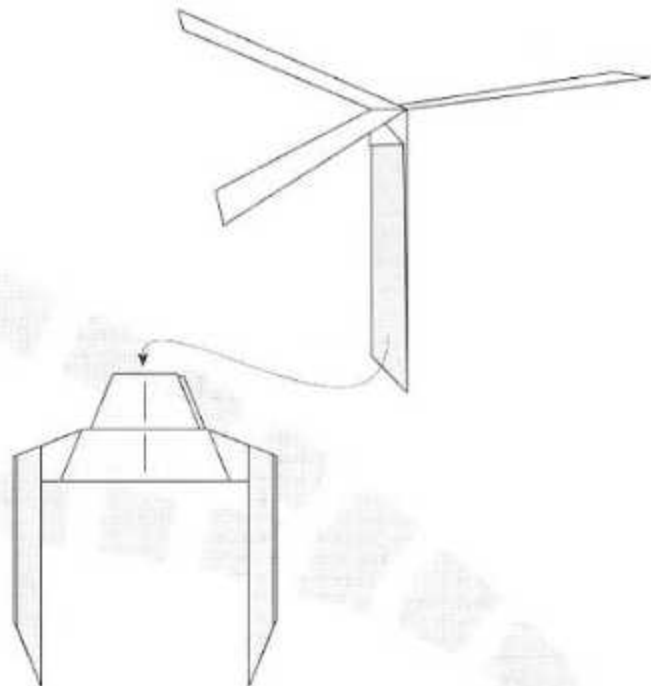
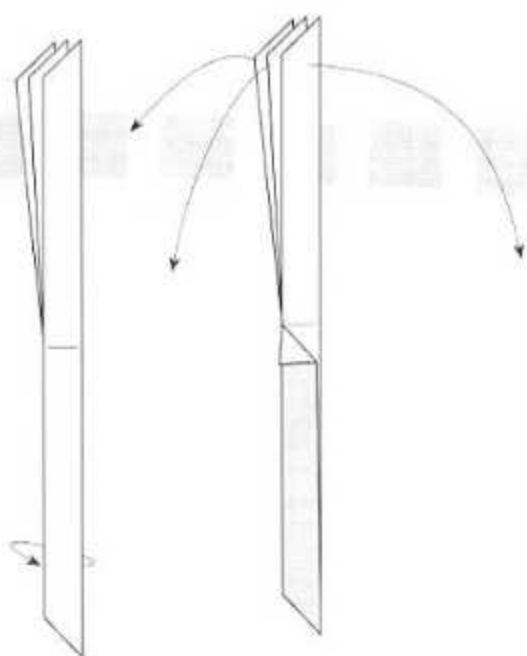

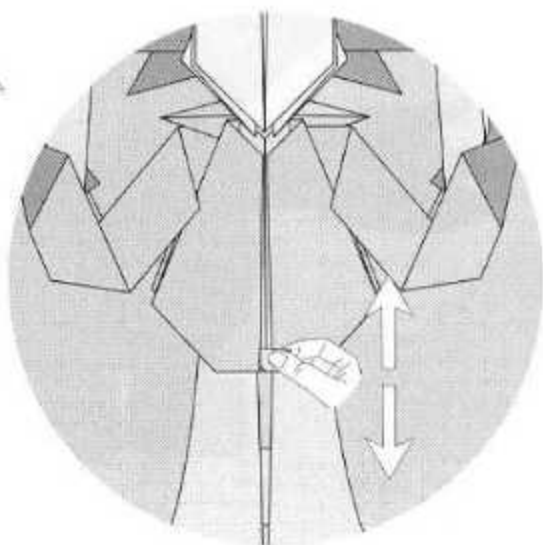
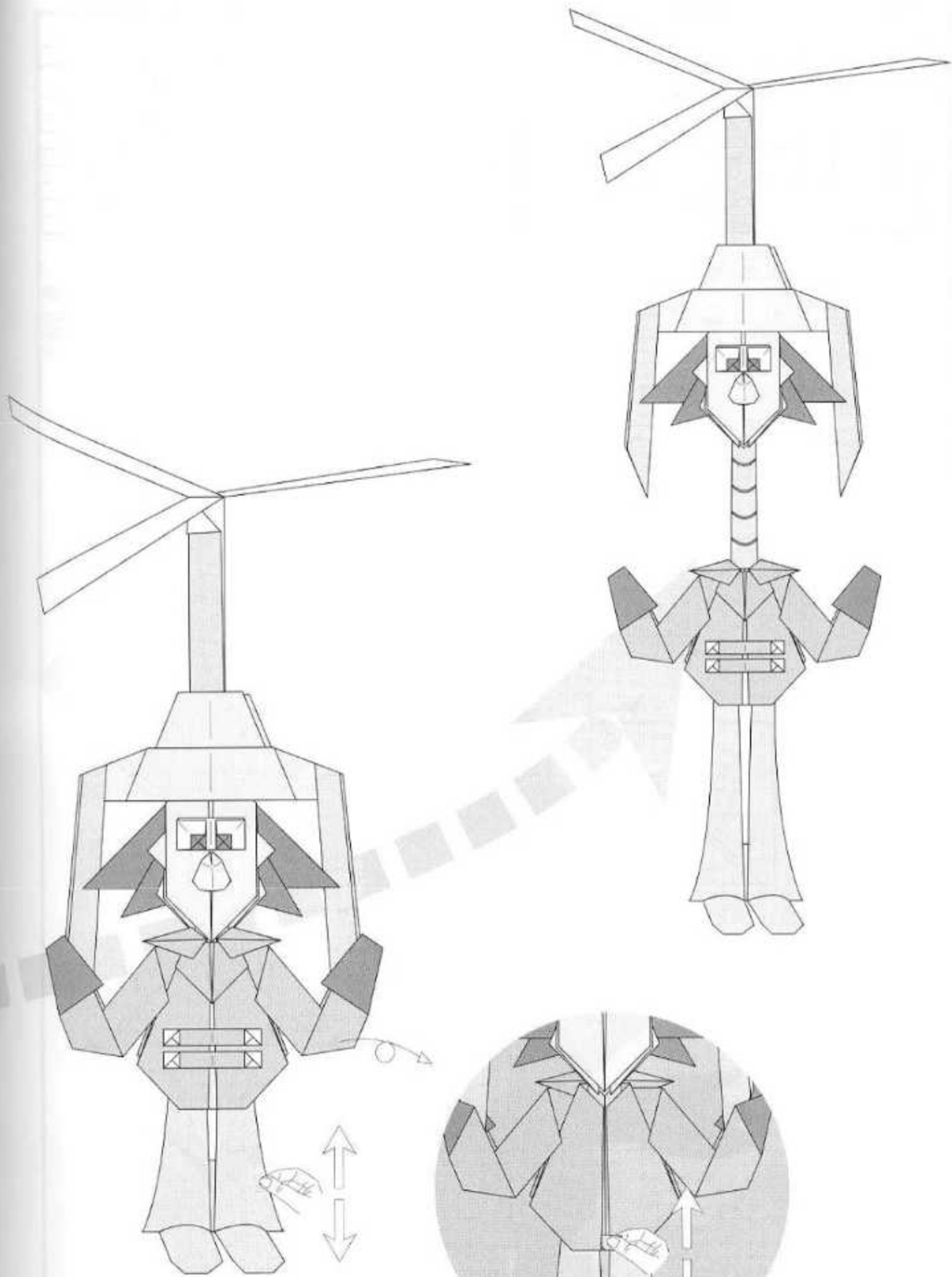

| Página (Desarr.) | Pieza nº | Cantidad | Porción | COLORES | | Tamaño original | Tamaño 3/10 | Tamaño 2/5 | Tamaño 3/5 |
|---------------------|----------|----------|---------|---------|---------|-----------------|-------------|-------------|-------------|
| | | | | Anverso | Reverso | 15 * cm alto | 4,5 cm alto | 6 cm alto | 9 cm alto |
| | | | | | | Lado (cm) = | Lado (cm) = | Lado (cm) = | Lado (cm) = |
| 57 | 1 | 1 | Cara | Azul | Blanco | 20 | 6 | 8 | 12 |
| 58 | 2 | 1 | Cuerpo | Rojo | Azul | 20 | 6 | 8 | 12 |
| 59 | 3 | 1 | Gorro | Neutro | Rojo | 20 | 6 | 8 | 12 |
| 59 | 4 | 2 | Brazos | Neutro | Azul | 7,5 | 2,25 | 3 | 4,5 |
| 60 | 5 | 2 | Piernas | Neutro | Rojo | 7,5 | 2,25 | 3 | 4,5 |
| 61 | 6 | 1 | Ojos | Negro | Blanco | 5 | 1,5 | 2 | 3 |
| 61 | 7 | 1 | Cola | Neutro | Azul | 5 | 1,5 | 2 | 3 |
| 62 | 8 | 2 | Pies | Neutro | Rojo | 7,5 | 2,25 | 3 | 4,5 |
| 63 | 9 | 2 | Manos | Neutro | Azul | 7,5 | 2,25 | 3 | 4,5 |

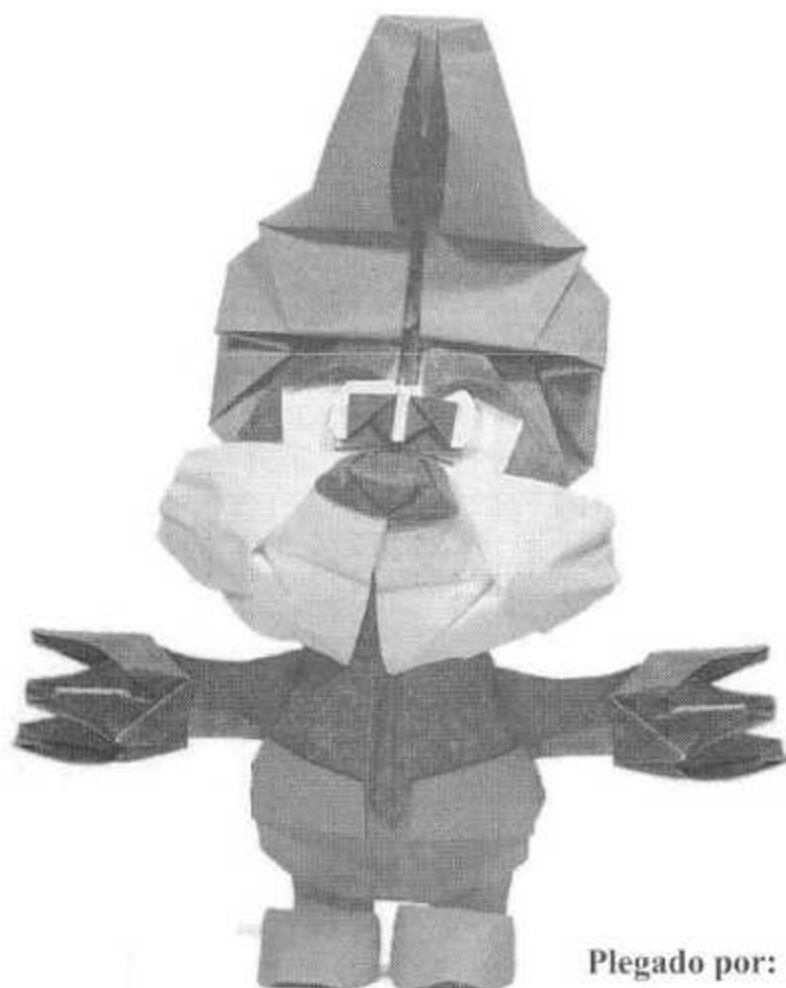

Plegado por: Halle

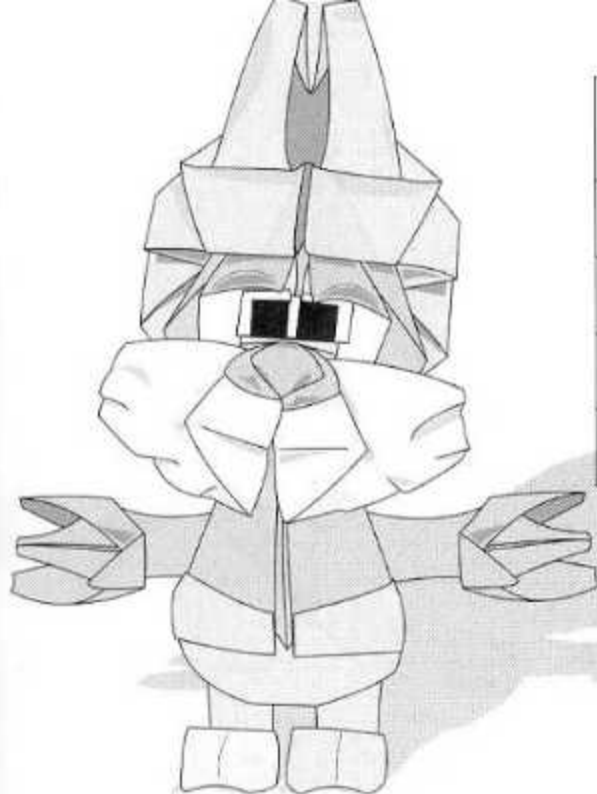

Utilizando las medidas recomendadas, se obtiene un modelo final de 15 cms.

| | |
|-----------------------------|-----------|
| Autor: | Halle |
| Nivel de dificultad: | Medio |
| Número de piezas: | 13 |
| Forma de las piezas: | Cuadrados |

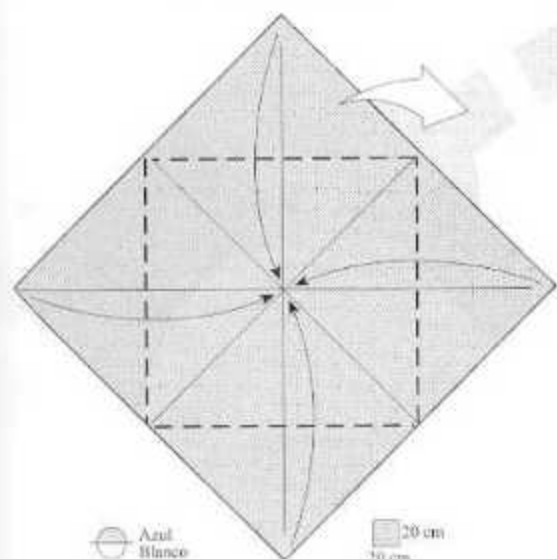

20 cm
20 cm

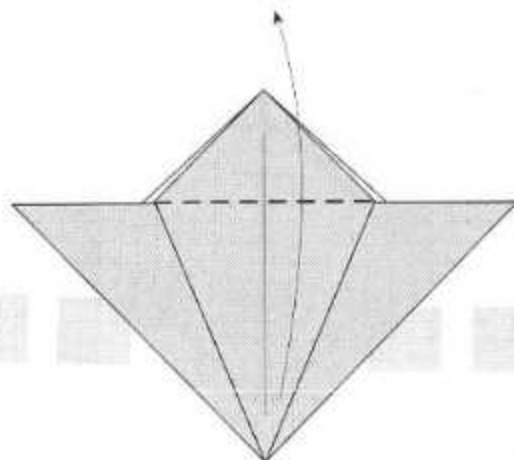
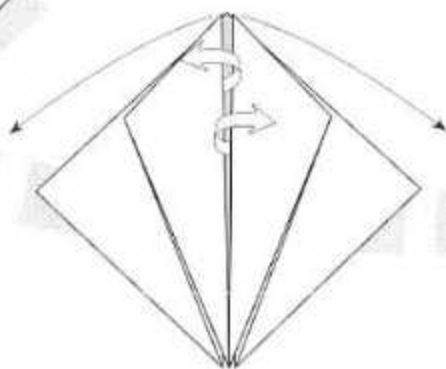
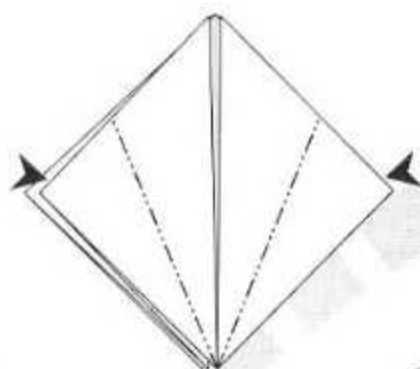
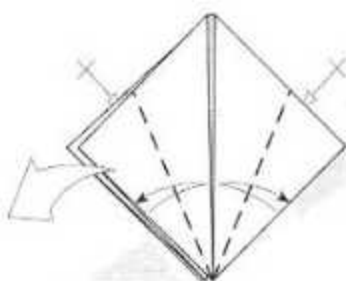
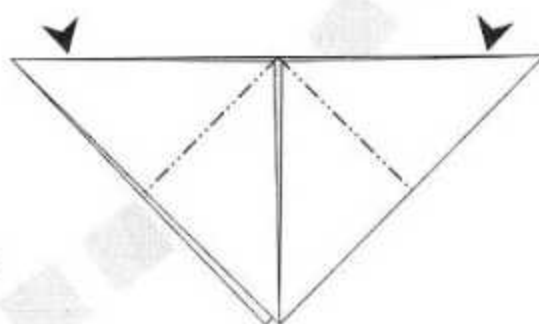
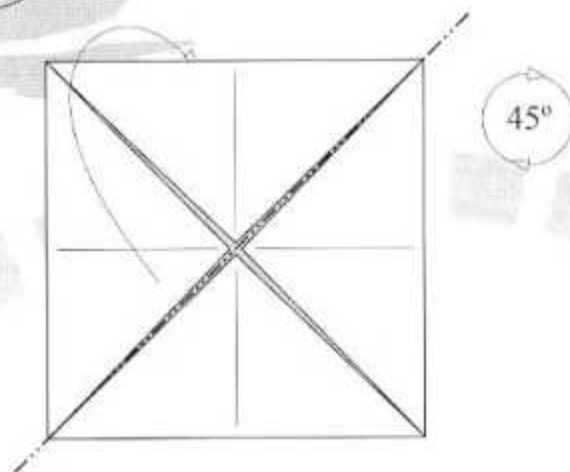

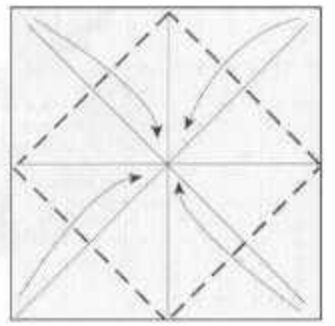
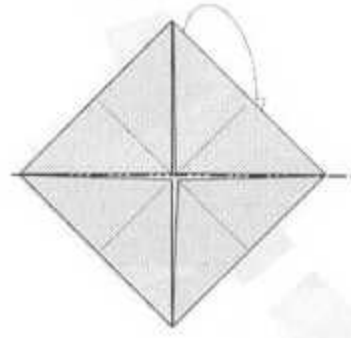
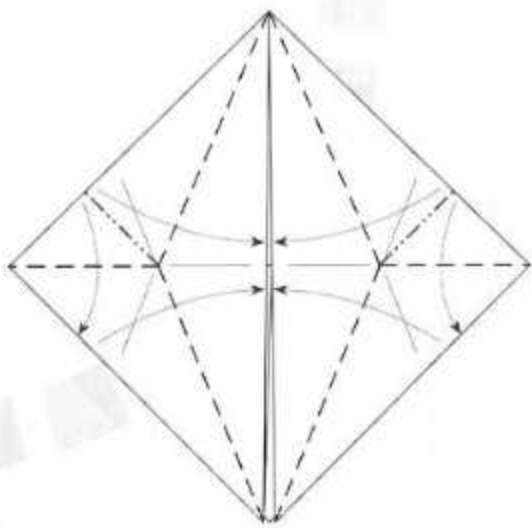
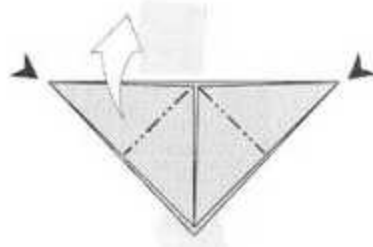
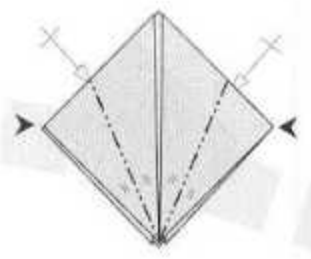
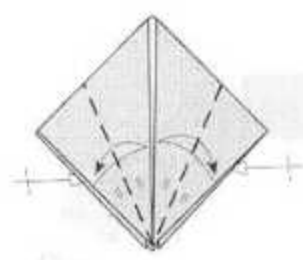
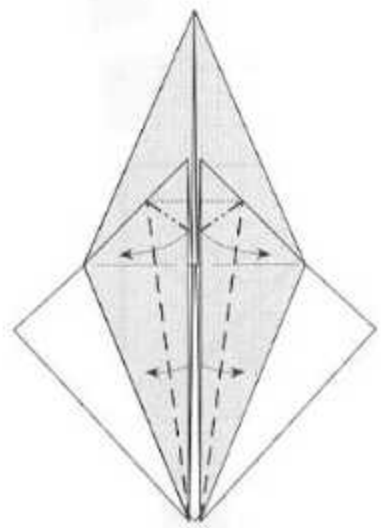
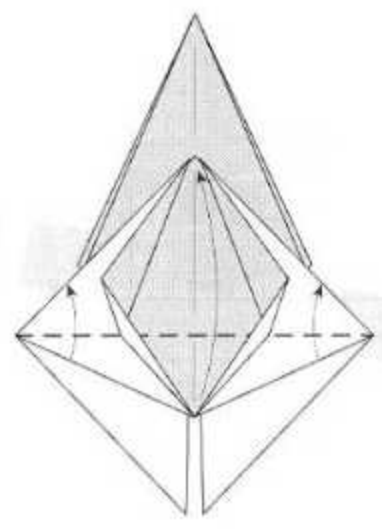
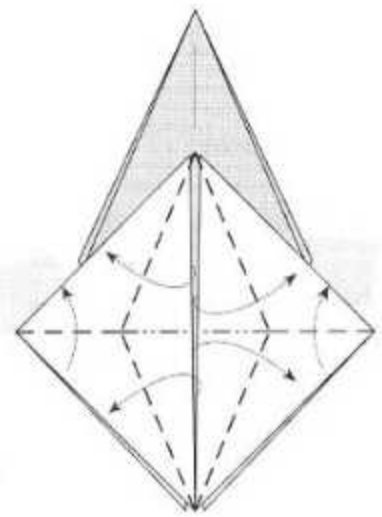
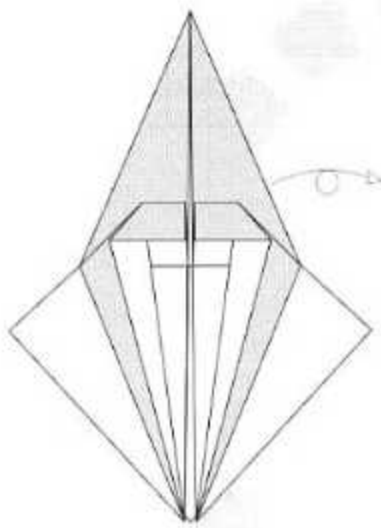

● Rojo
● Azul

□ 20 cm
□ 20 cm



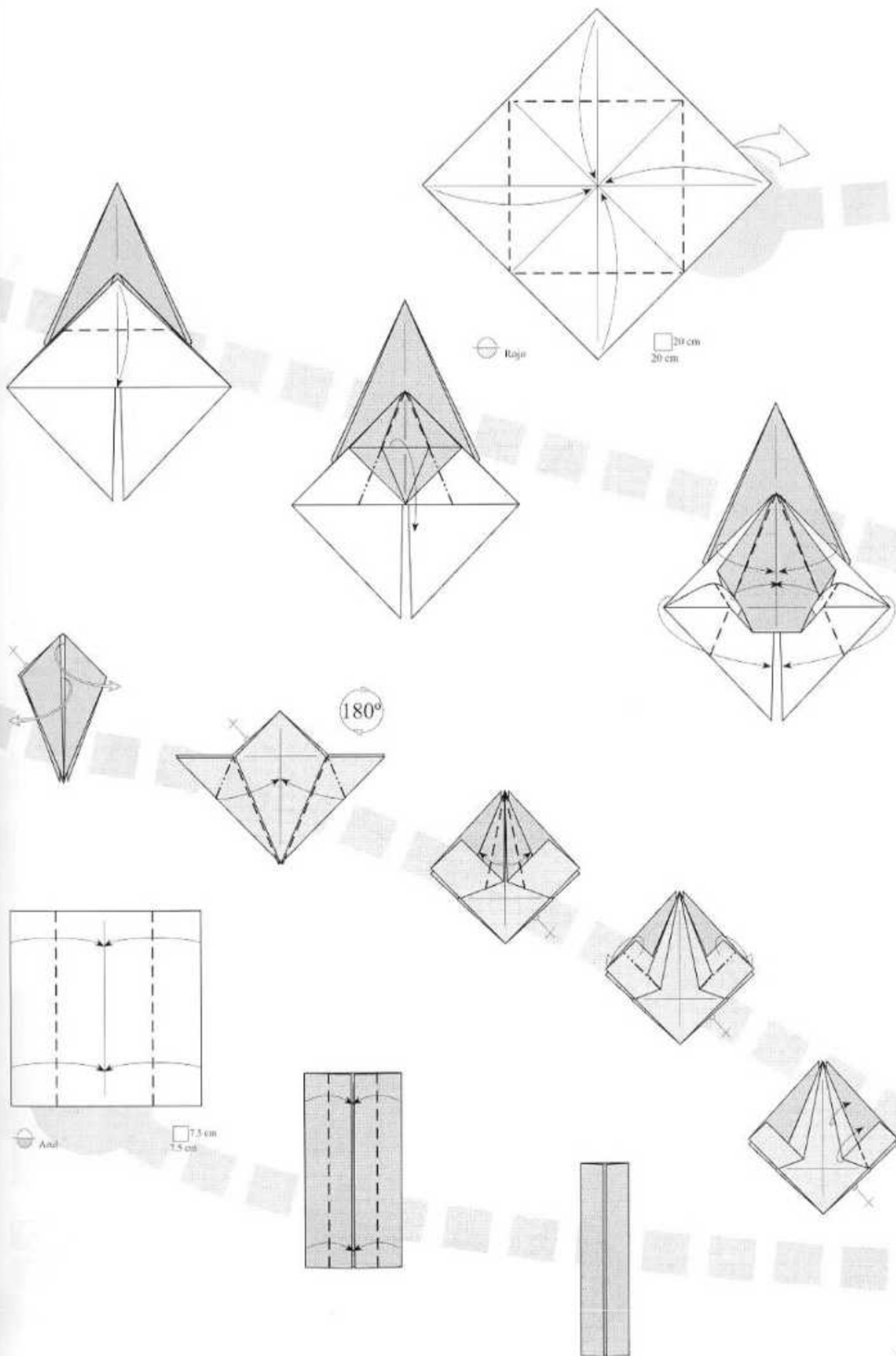

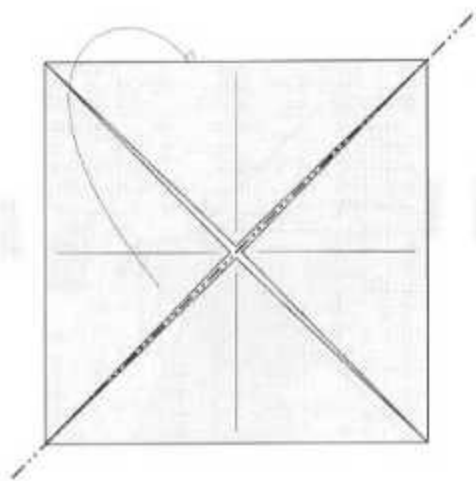

45°

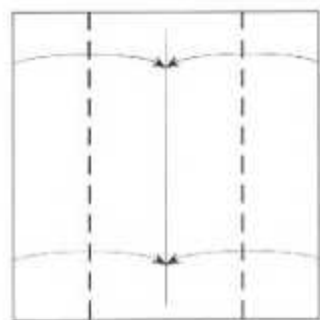
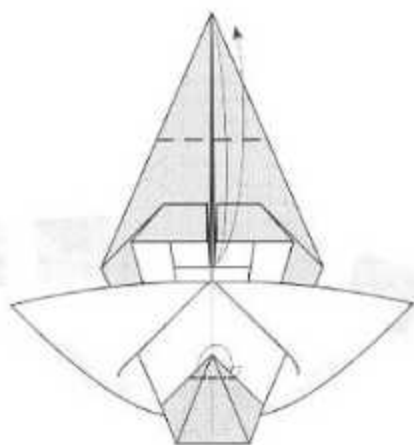
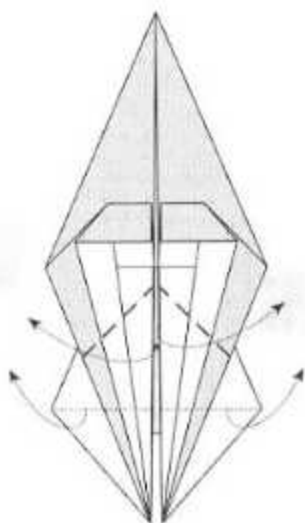
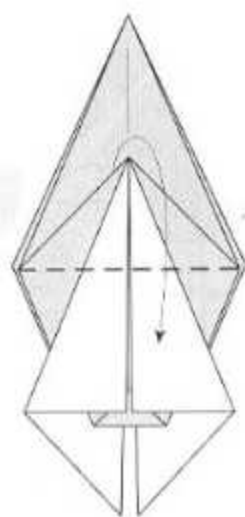
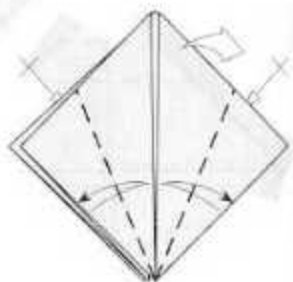
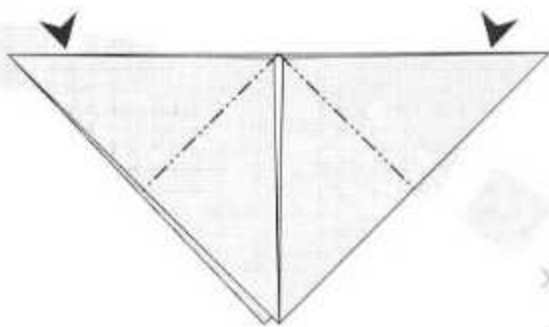

8cm

7.5 cm
2.3 cm

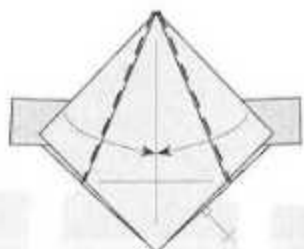
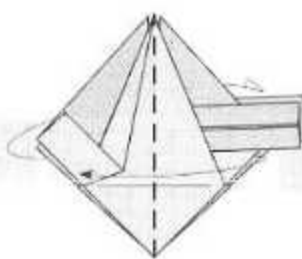
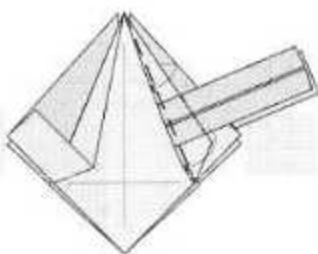
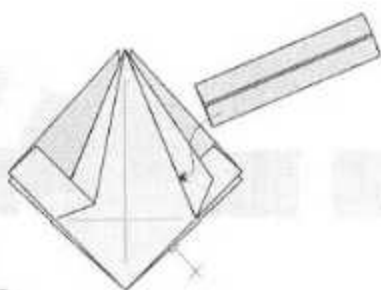
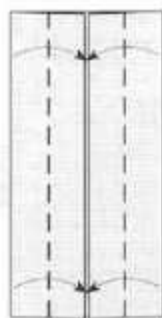

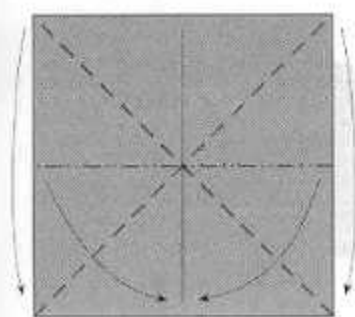
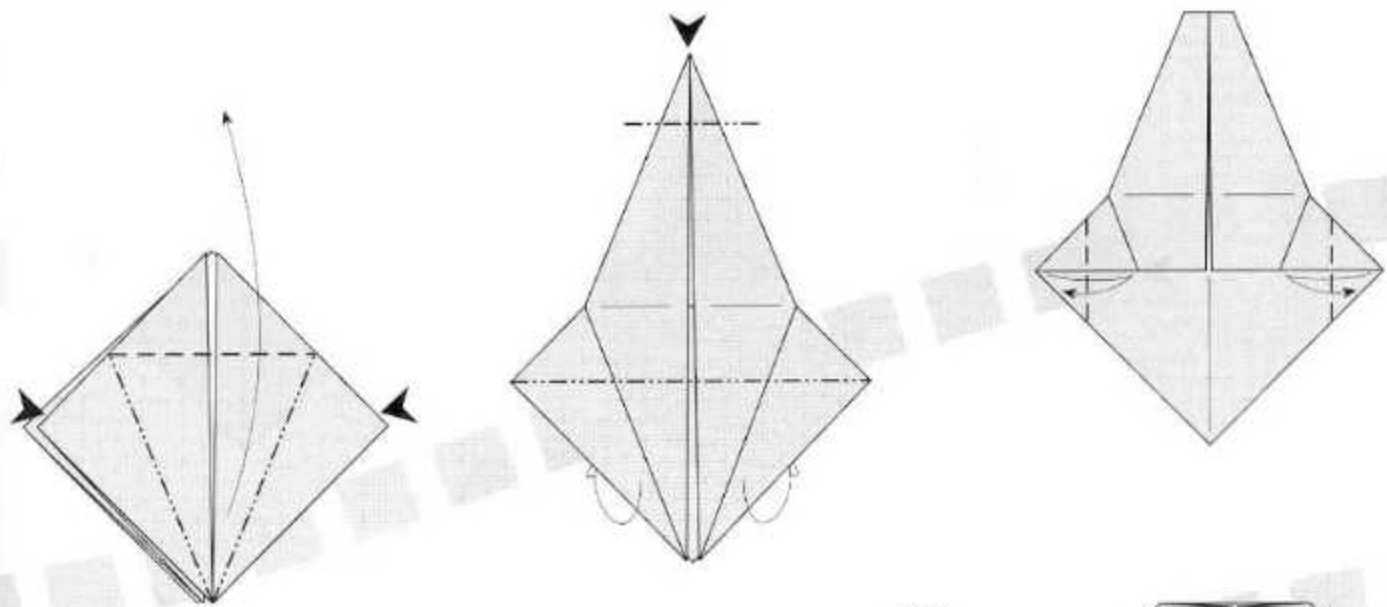

● Negro
○ Blanco

■ 5 cm
□ 3 cm

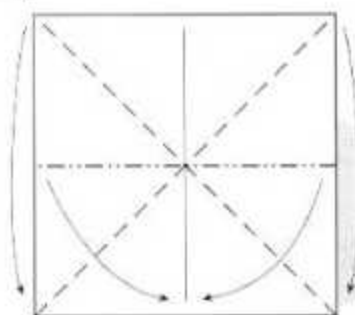
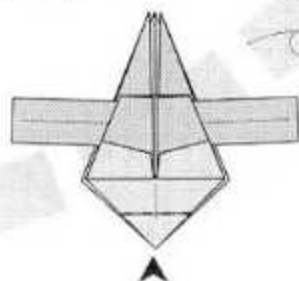
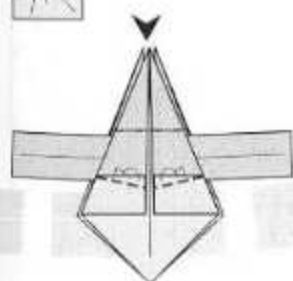
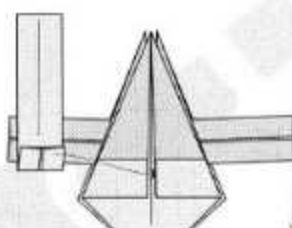
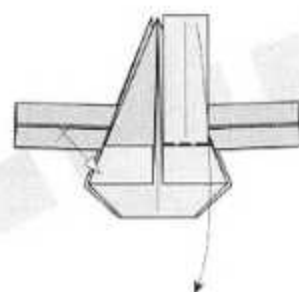
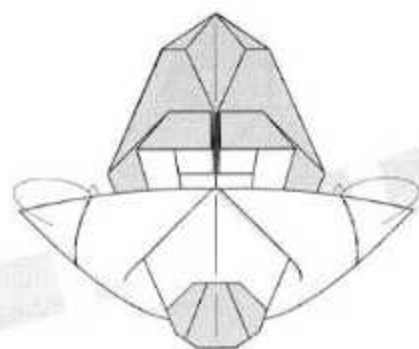
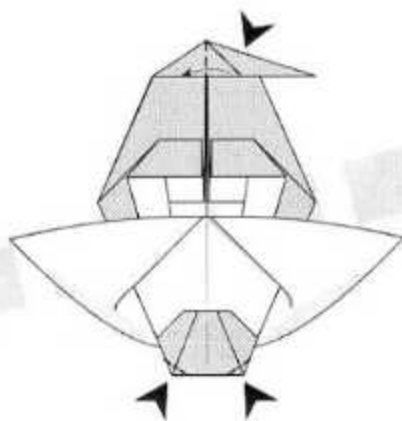
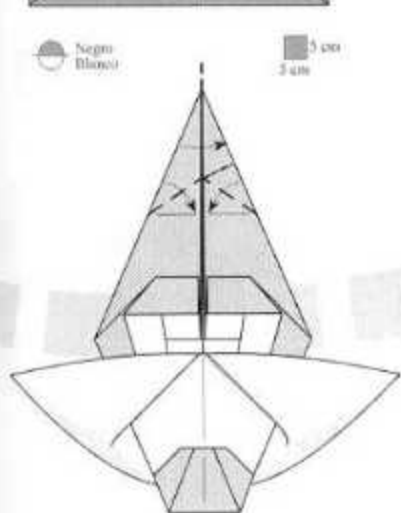
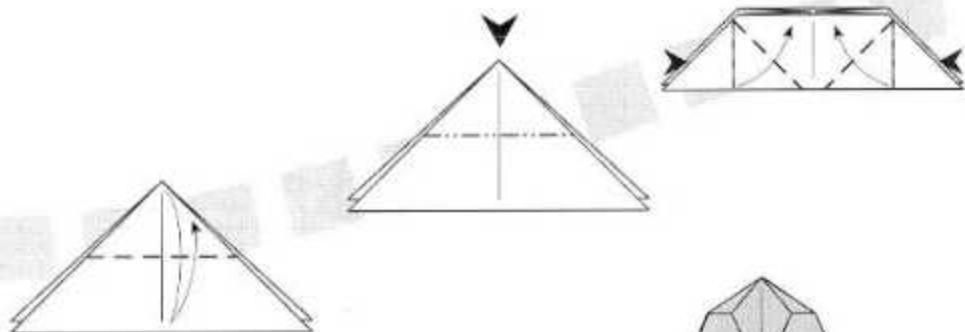

● Azul

□ 5 cm



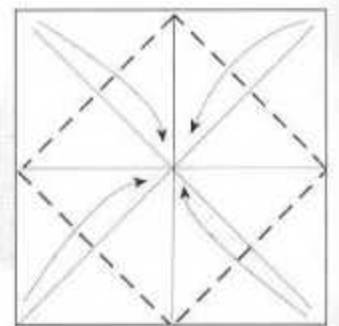
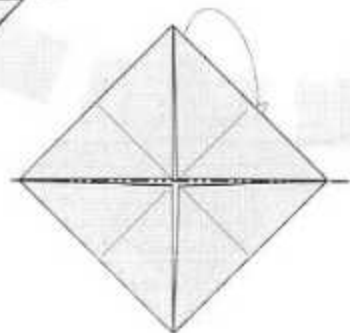
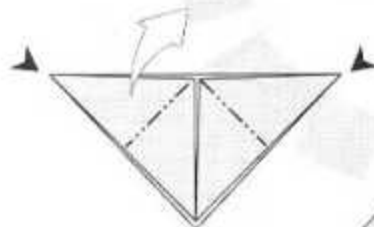
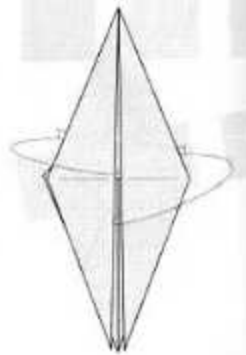
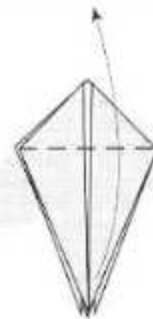
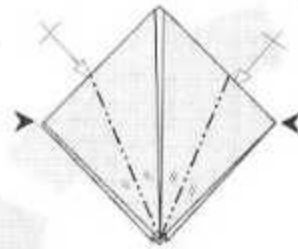
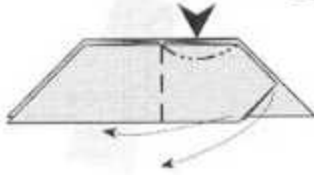
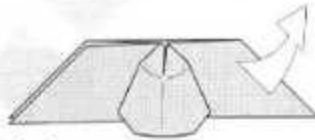
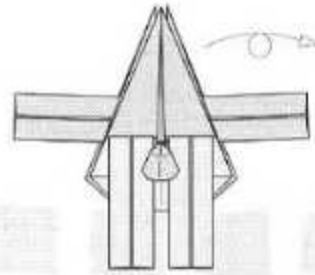
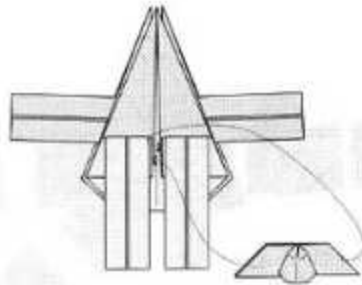
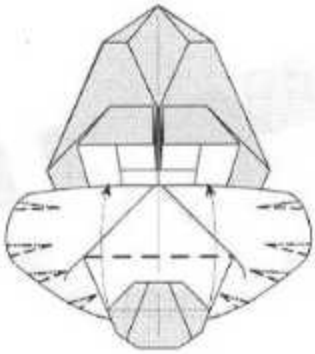
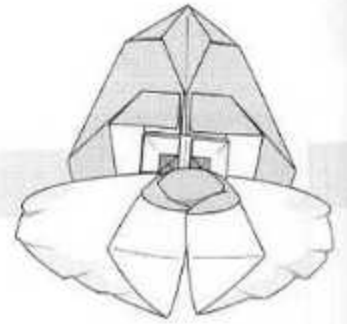
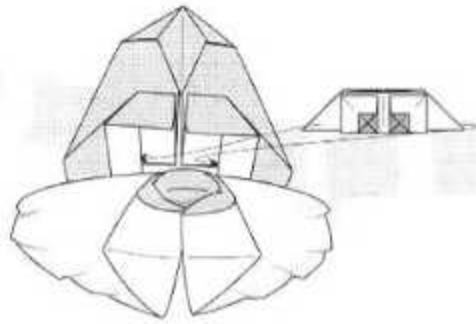
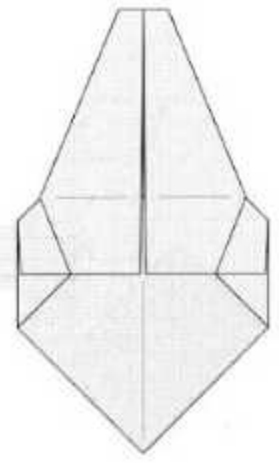
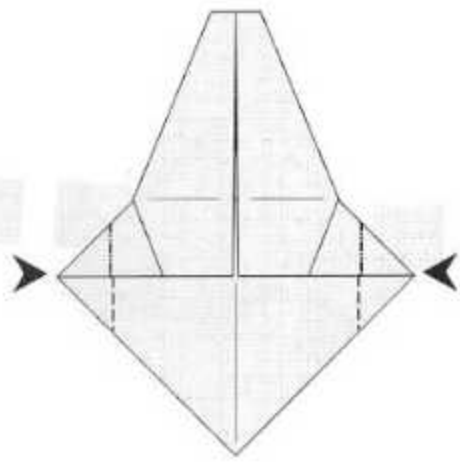

Rojo

7.5 cm
7.5 cm



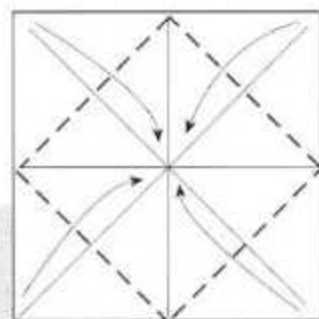
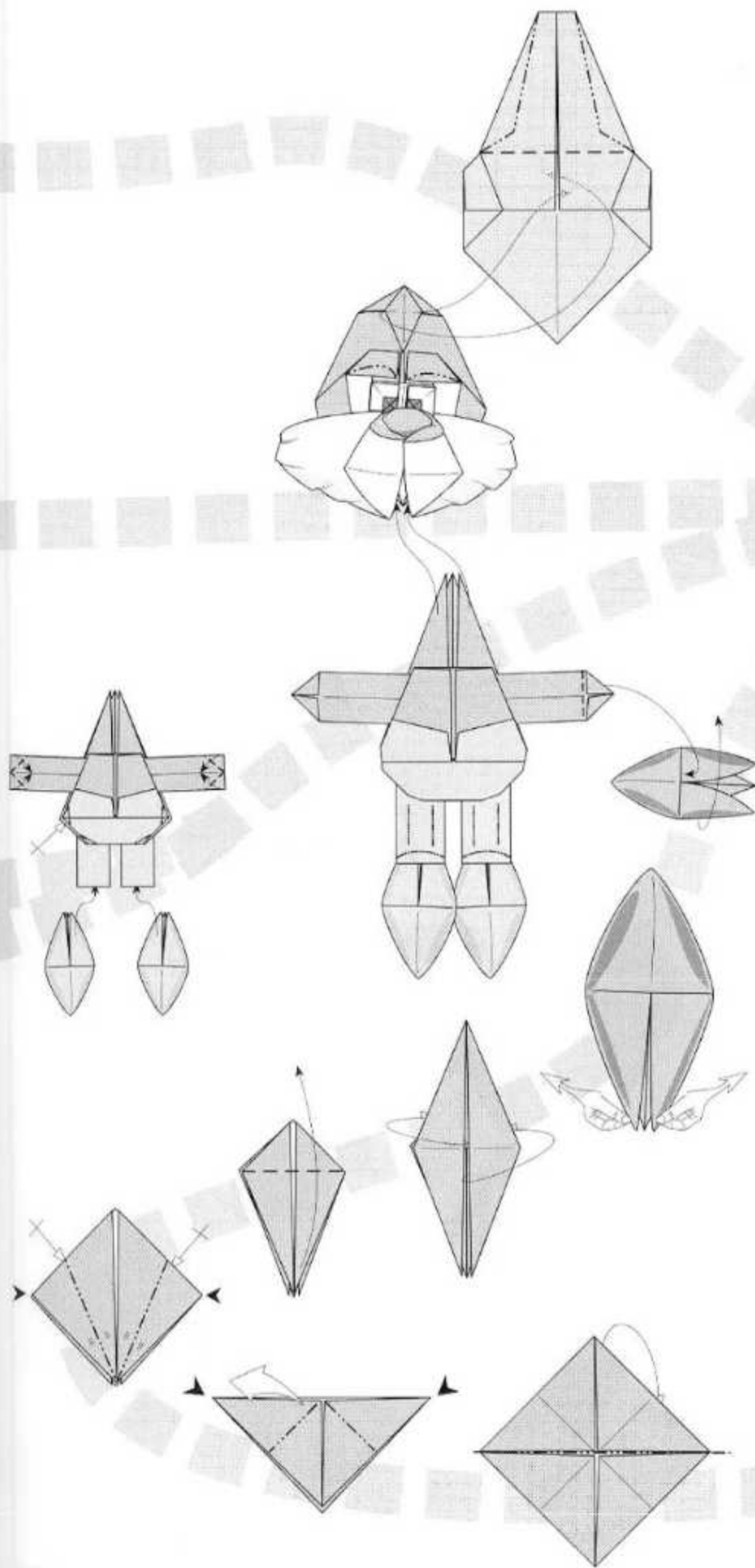

⊖ Azul

7.5 cm
7.5 cm



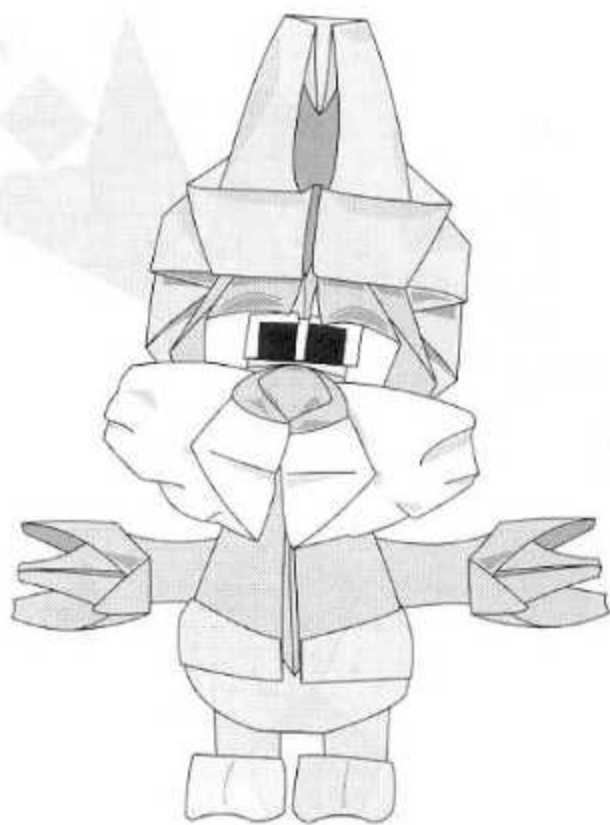
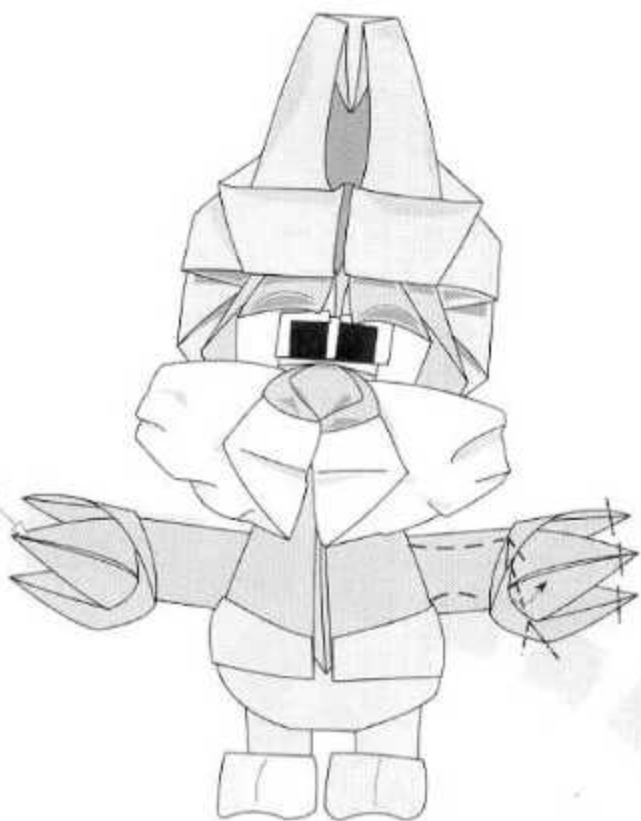

| Página (Desarr.) | Pieza nº | Cantidad | Porción | COLORES | | Tamaño original | Tamaño 3/10 | Tamaño 2/5 | Tamaño 3/5 |
|---------------------|----------|----------|---------|---------|---------|-----------------|----------------|--------------|--------------|
| | | | | Anverso | Reverso | 15 cm alto | 4,5 cm alto | 6 cm alto | 9 cm alto |
| | | | | | | Lado (cm) = | Lado (cm) = | Lado (cm) = | Lado (cm) = |
| 66 | 1 | 1 | Brazos | Neutro | Gris | 10 | 3 | 4 | 6 |
| 66 | 2 | 1 | Cuerpo | Neutro | Gris | 20 | 6 | 8 | 12 |
| 67 | 3 | 1 | Patas | Neutro | Gris | 15 | 4,5 | 6 | 9 |
| 68 | 4 | 1 | Orejas | Naranja | Gris | 20 | 6 | 8 | 12 |
| 69 | 5 | 1 | Corbata | Neutro | Azul | 5 | 1,5 | 2 | 3 |
| 70 | 6 | 1 | Ojos | Negro | Blanco | 5 | 1,5 | 2 | 3 |
| 70 | 7 | 1 | Morrito | Negro | Naranja | 5 | 1,5 | 2 | 3 |



Plegado por: J.A.V.I.

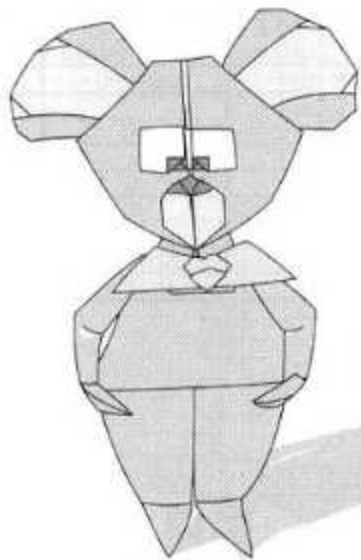

Utilizando las medidas recomendadas, se obtiene un modelo final de 15 cms.

| | |
|-----------------------------|------------|
| Autor: | Halle |
| Nivel de dificultad: | Medio-Alto |
| Número de piezas: | 7 |
| Forma de las piezas: | Cuadrados |

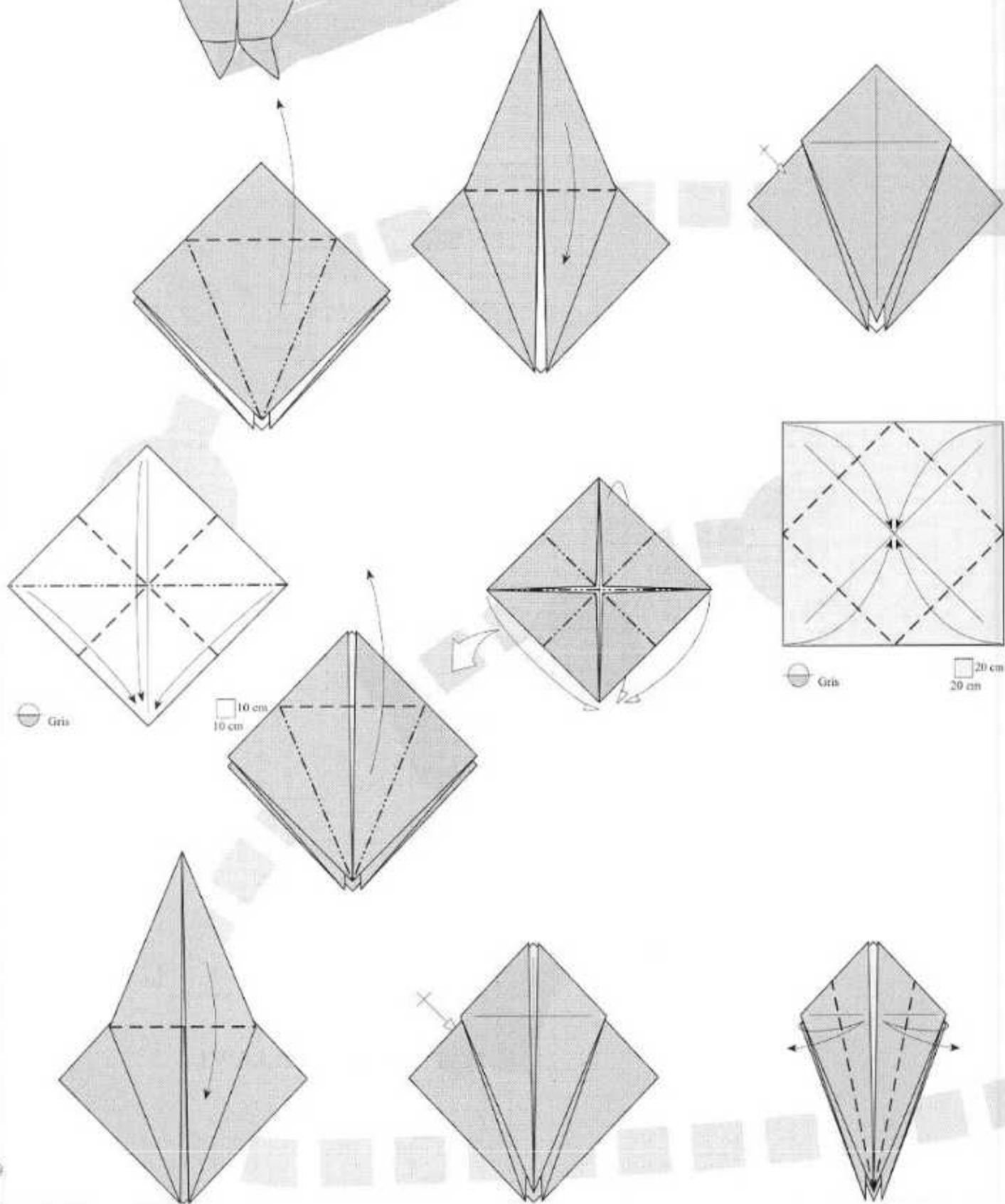

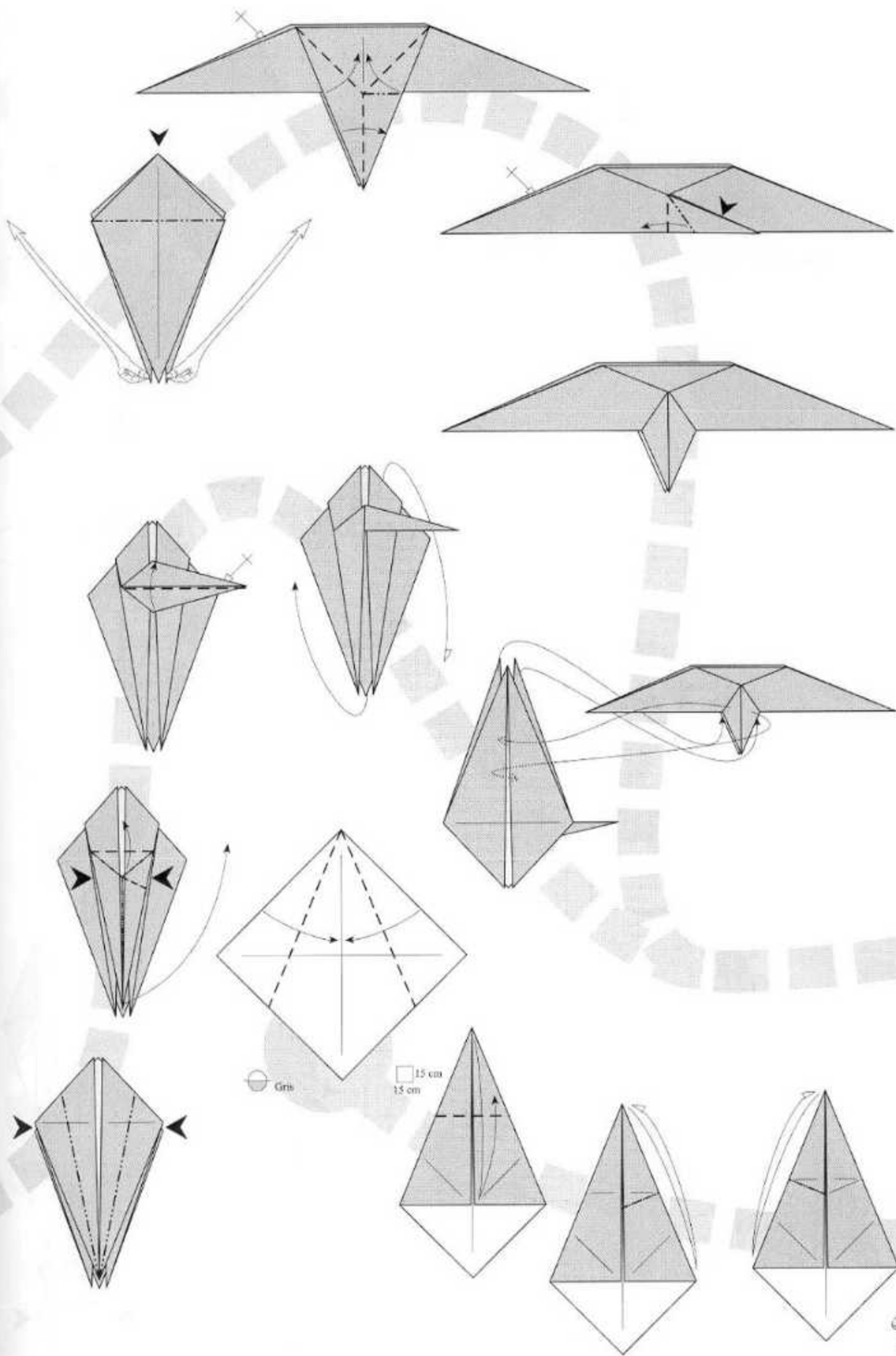

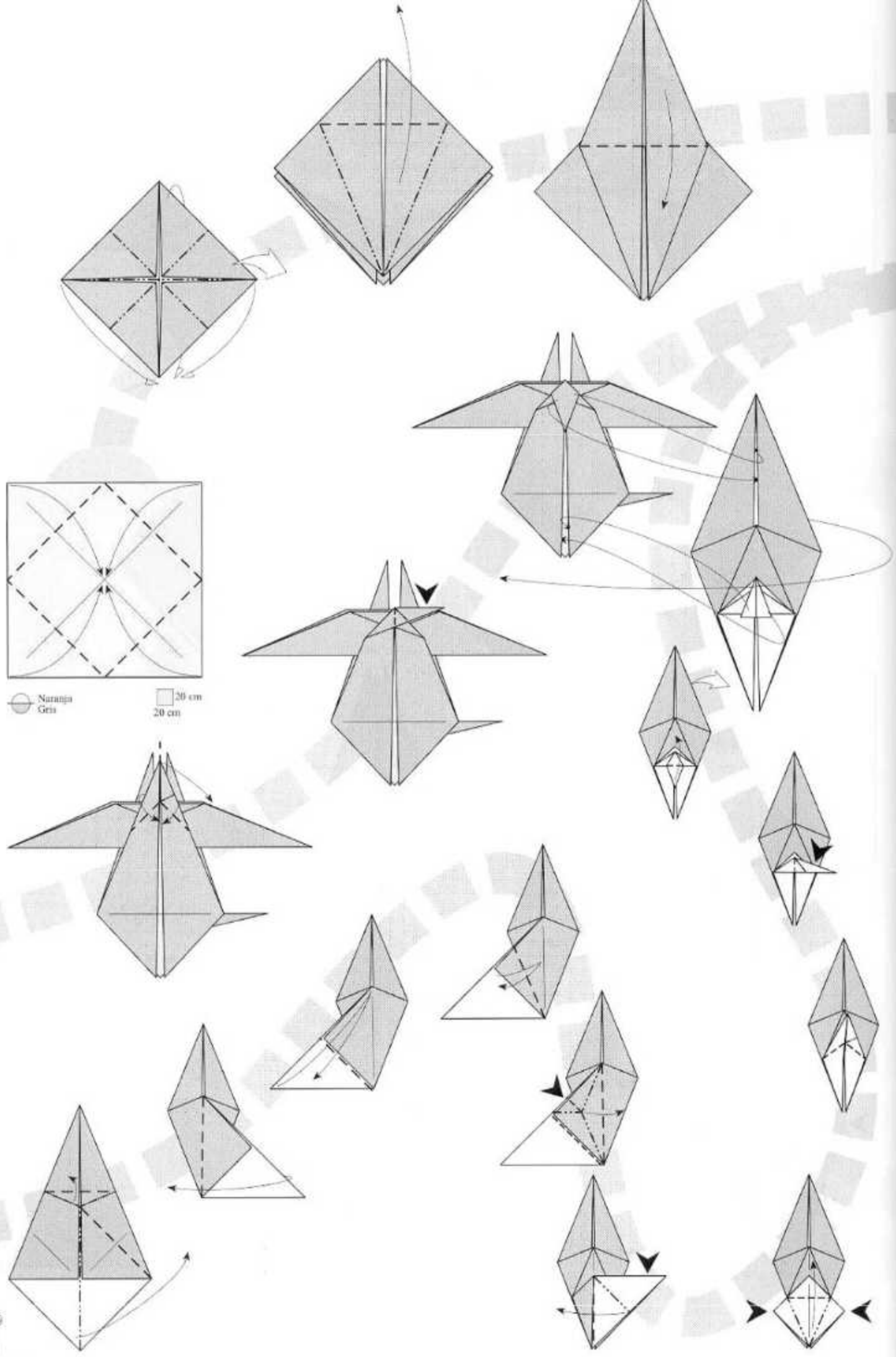

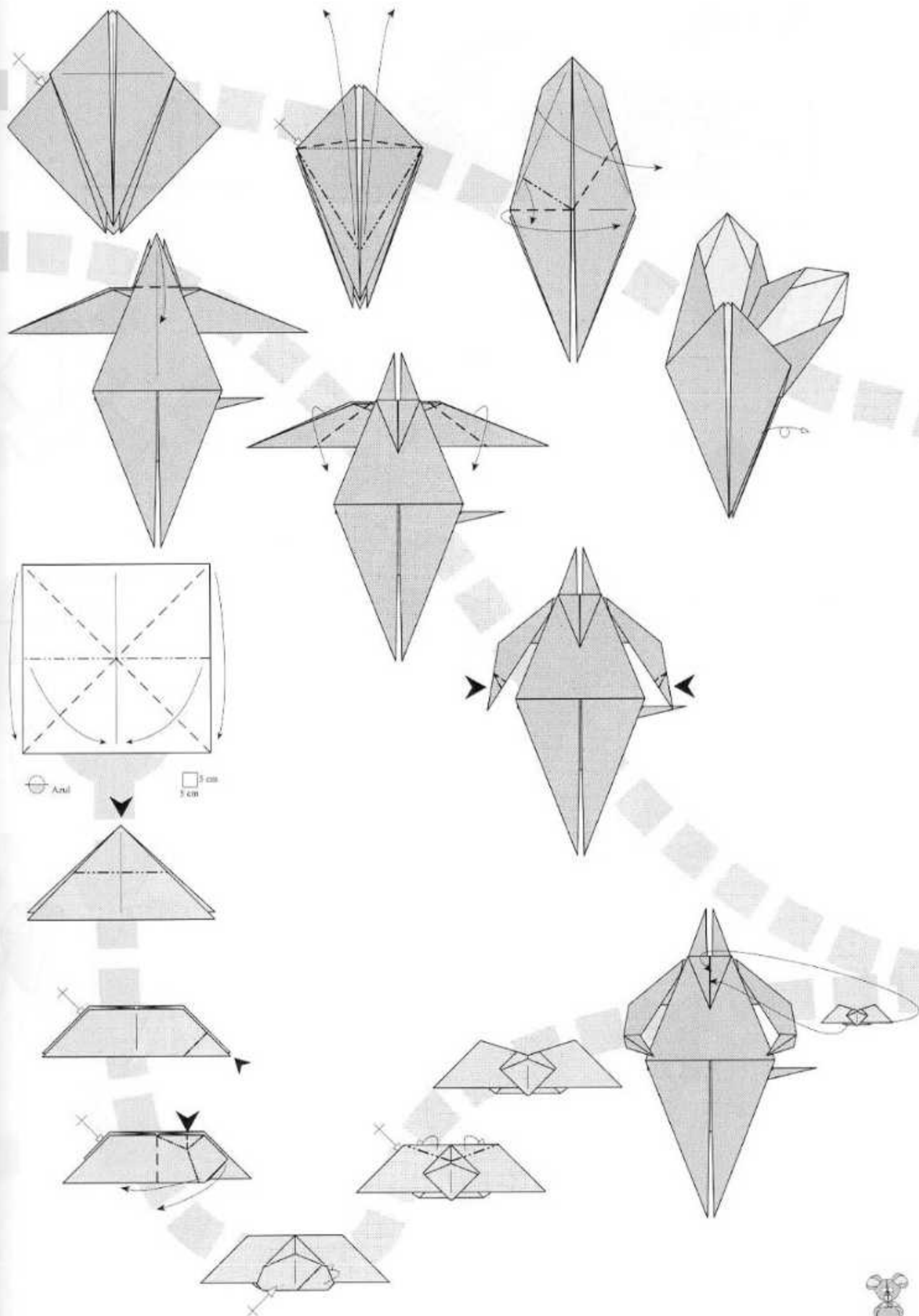

⊕ Anil

□ 2 cm
1 cm



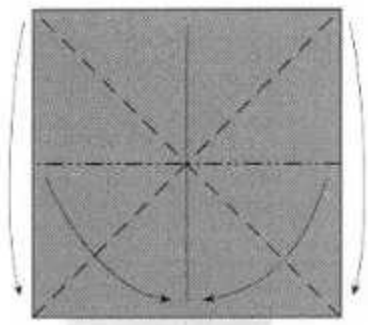

● Negro
○ Blanco

■ 5 cm
□ 5 cm

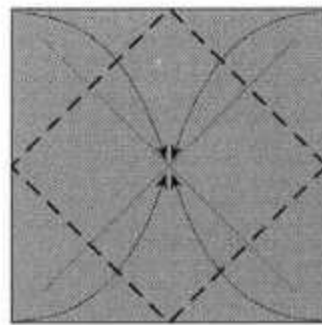

● Negro
○ Naranja

■ 5 cm
□ 5 cm

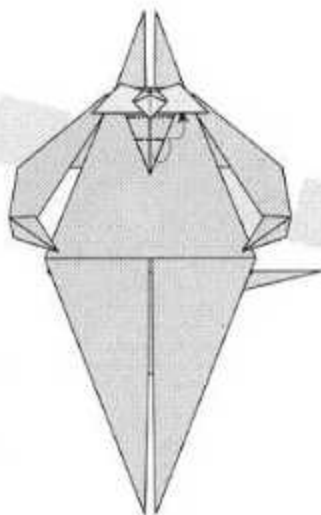
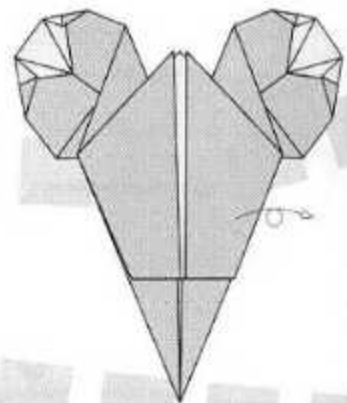
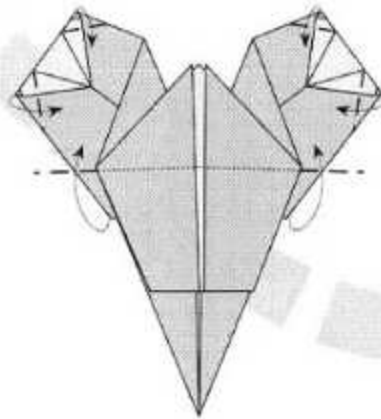
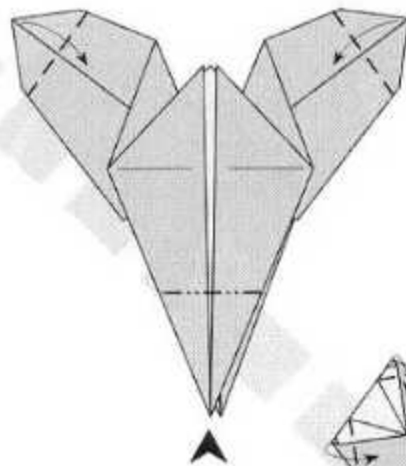
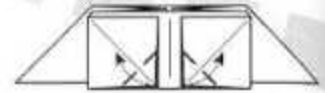
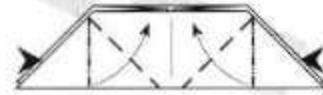
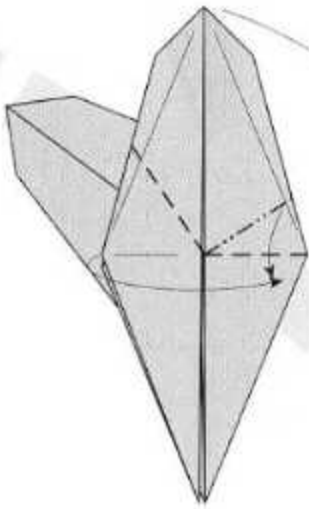
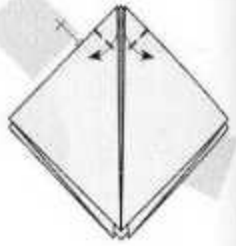
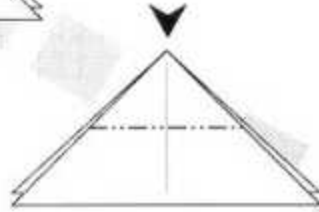
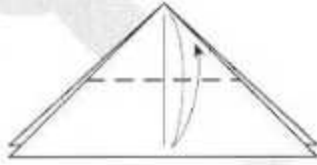
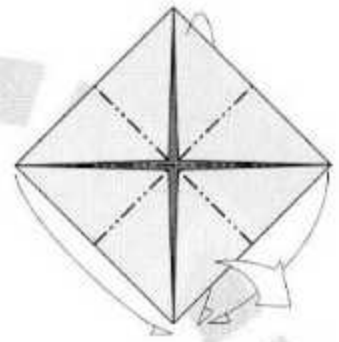

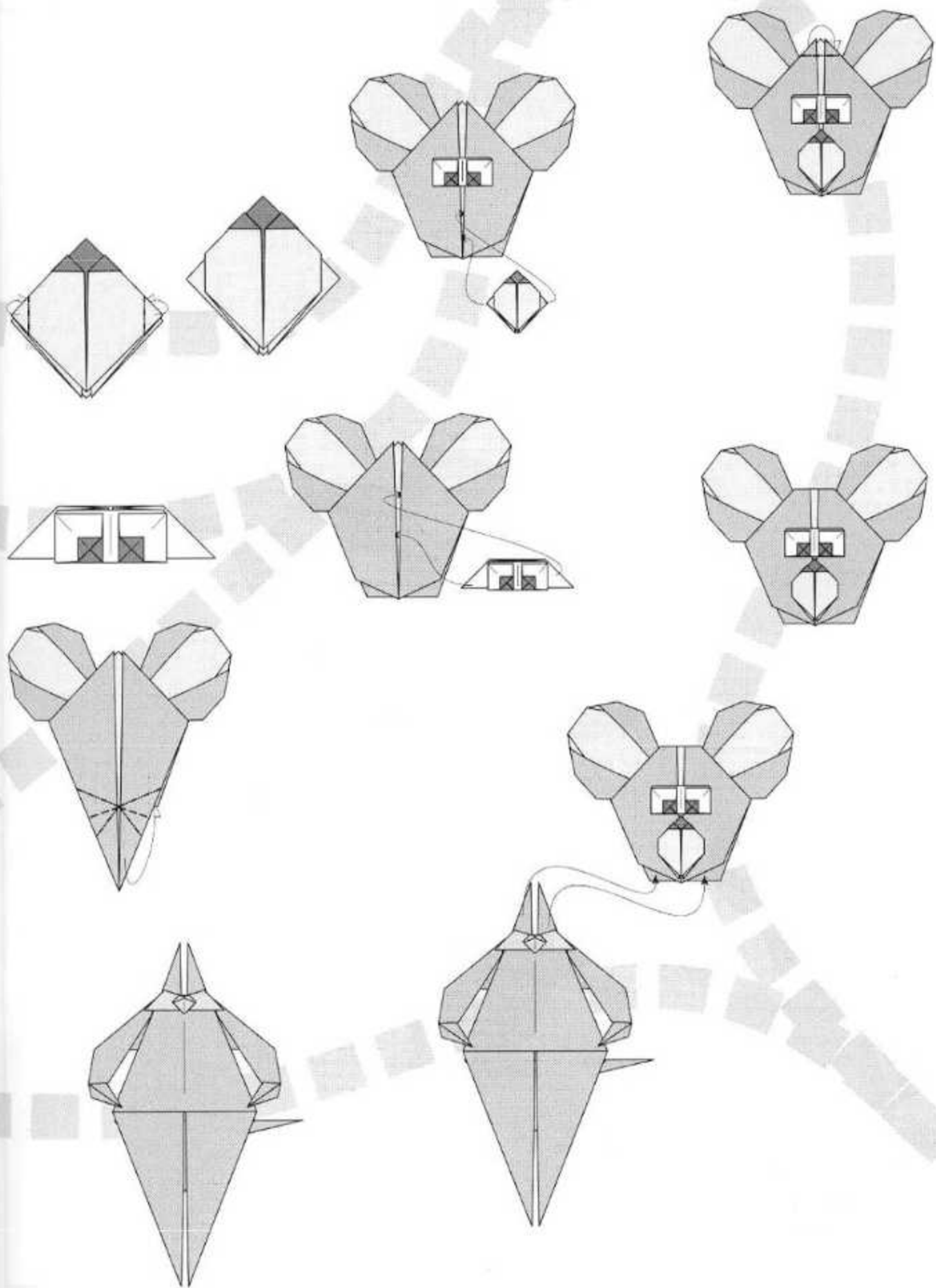

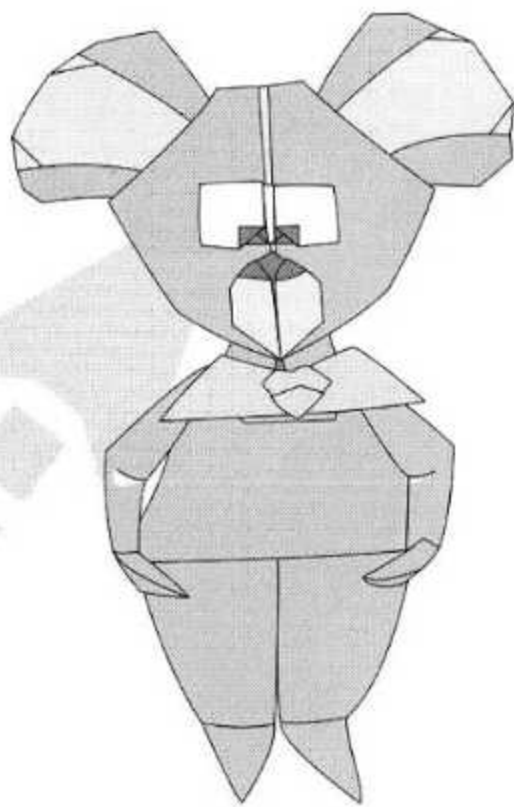
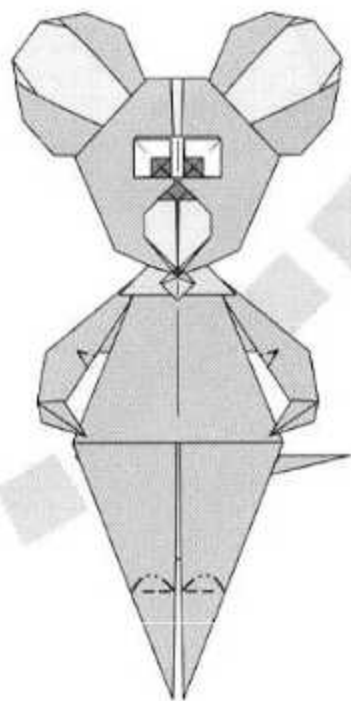

| Página (Desarr.) | Pieza nº | Cantidad | Porción | COLORES | | Tamaño original | Tamaño 3/10 | Tamaño 2/5 | Tamaño 3/5 |
|---------------------|----------|----------|---------|---------|---------|-----------------|-------------|-------------|-------------|
| | | | | Anverso | Reverso | 15 cm alto | 4,5 cm alto | 6 cm alto | 9 cm alto |
| | | | | | | Lado (cm) = | Lado (cm) = | Lado (cm) = | Lado (cm) = |
| 74 | 1 | 1 | Brazos | Neutro | Gris | 10 | 3 | 4 | 6 |
| 74 | 2 | 1 | Cuerpo | Neutro | Gris | 20 | 6 | 8 | 12 |
| 75 | 3 | 1 | Patás | Neutro | Gris | 15 | 4,5 | 6 | 9 |
| 76 | 4 | 1 | Orejas | Naranja | Gris | 20 | 6 | 8 | 12 |
| 77 | 6 | 1 | Ojos | Negro | Blanco | 5 | 1,5 | 2 | 3 |
| 77 | 7 | 1 | Morrito | Negro | Naranja | 5 | 1,5 | 2 | 3 |

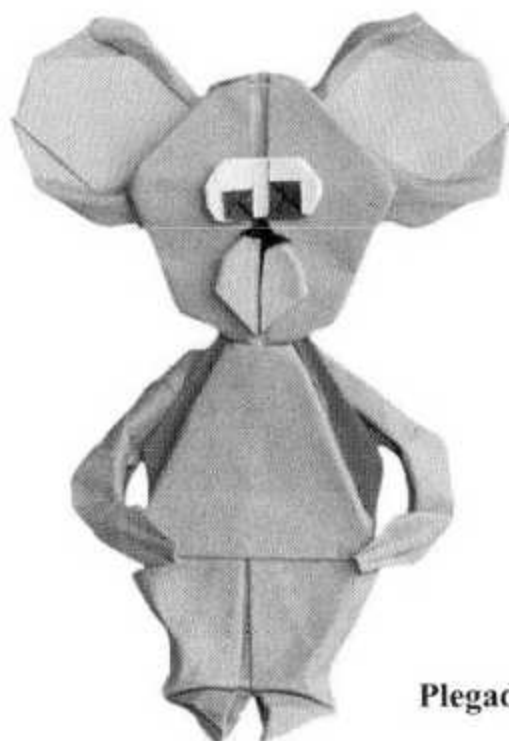

Plegado por: Halle

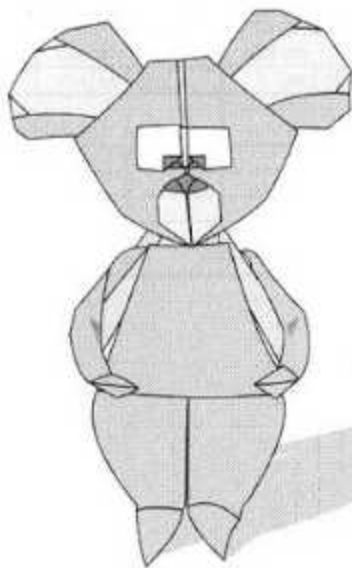

Utilizando las medidas recomendadas, se obtiene un modelo final de 15 cms.

| | |
|-----------------------------|------------|
| Autor: | Halle |
| Nivel de dificultad: | Medio-Alto |
| Número de piezas: | 6 |
| Forma de las piezas: | Cuadrados |

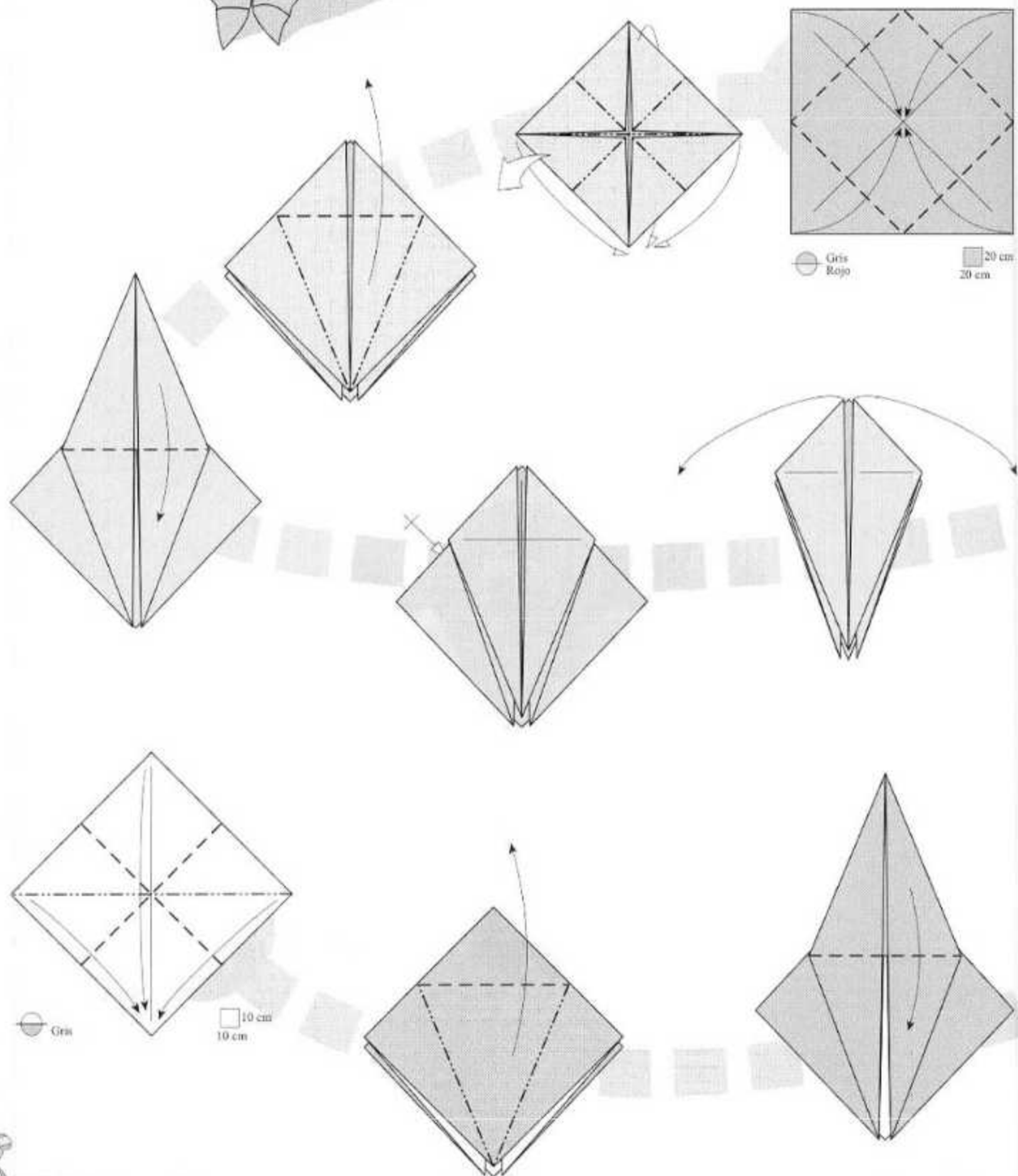

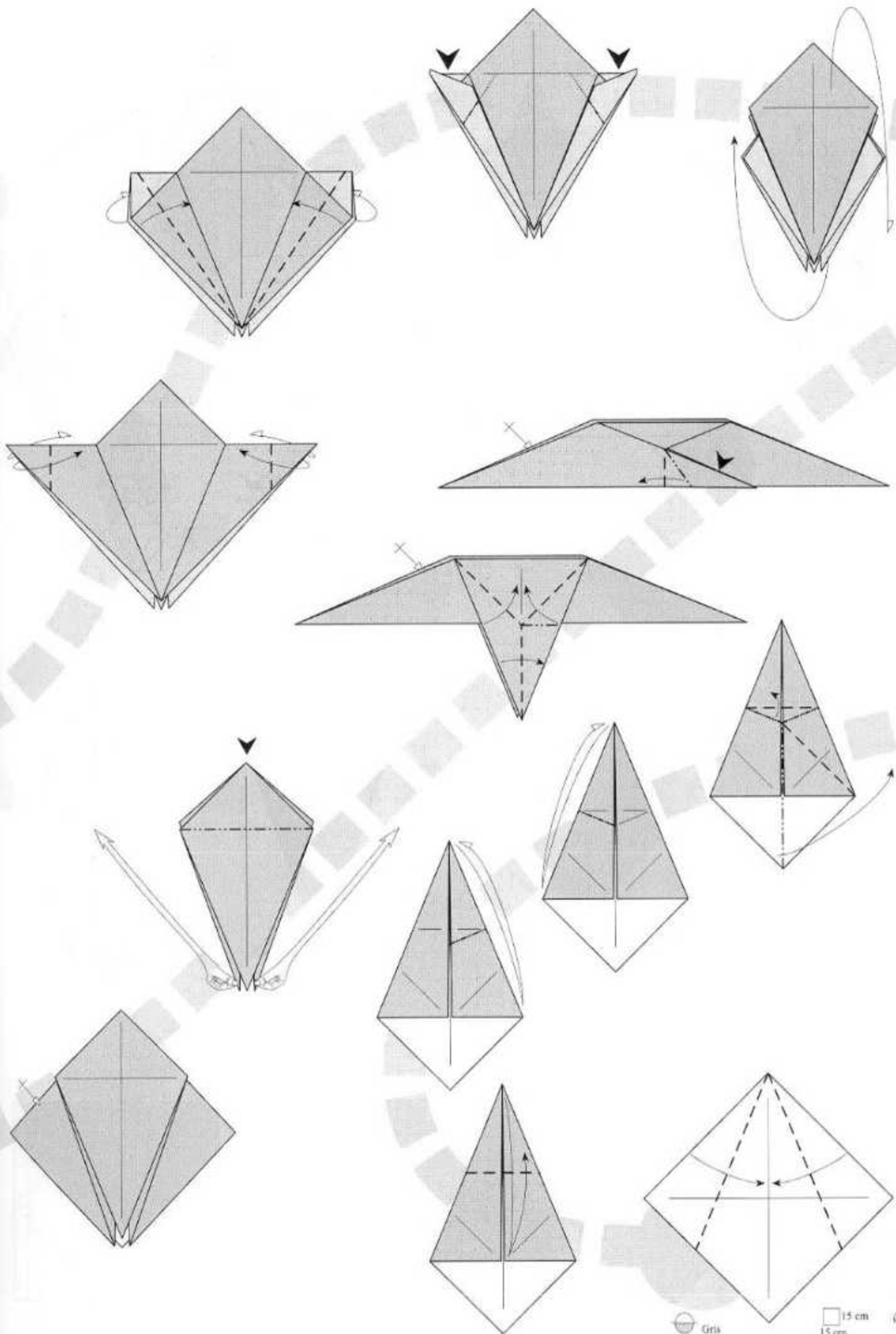

Gris

15 cm
15 cm



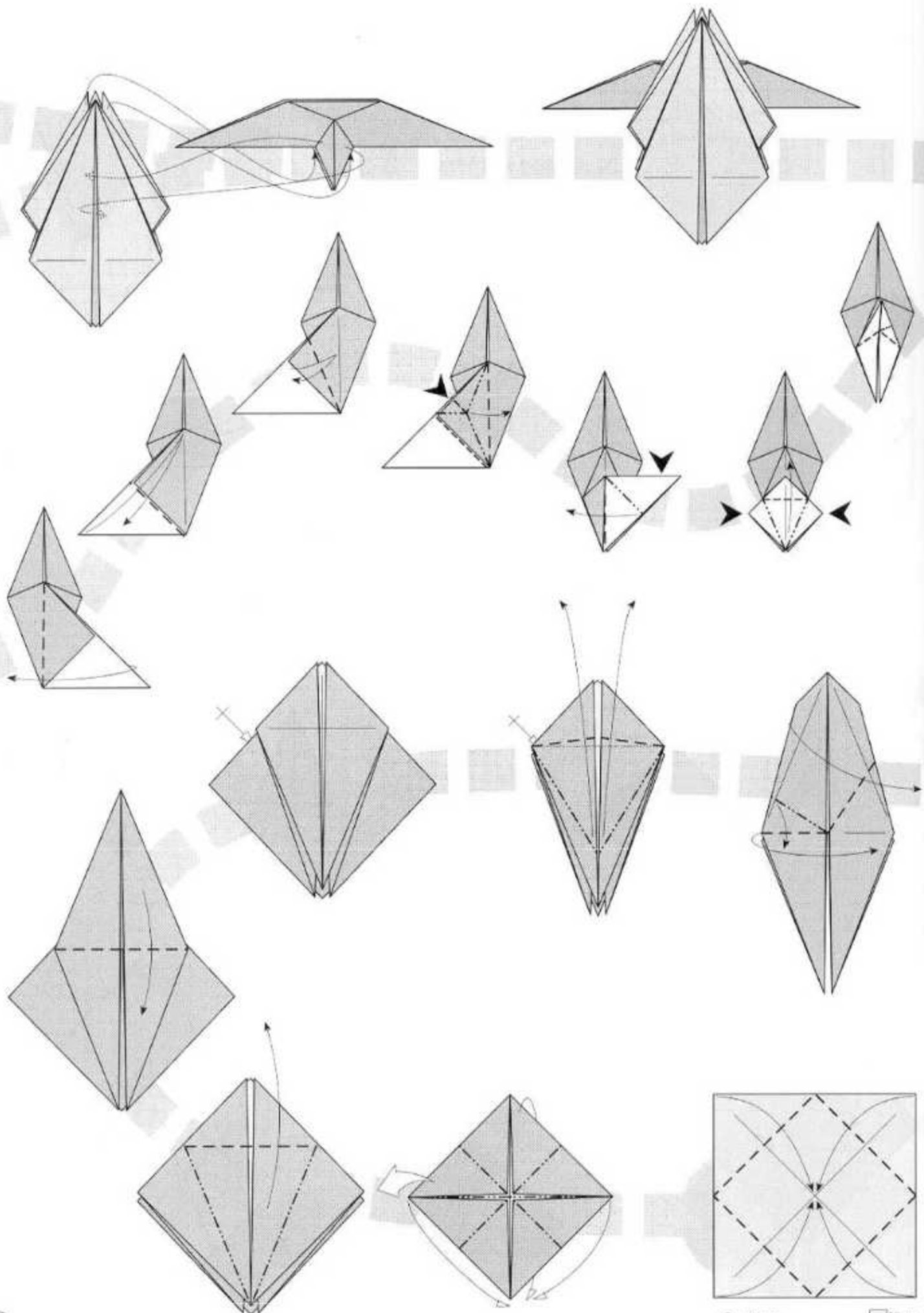

Narandja
 Gris
 20 cm
 20 cm

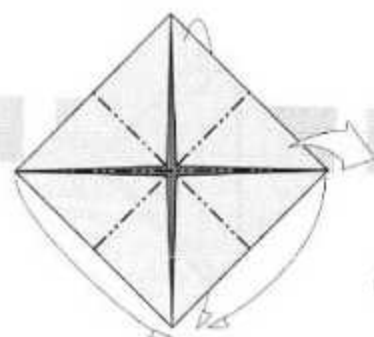
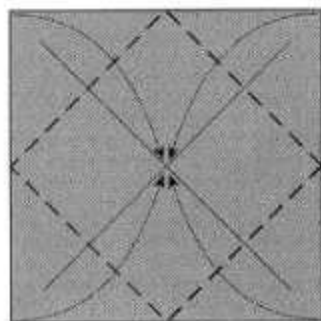
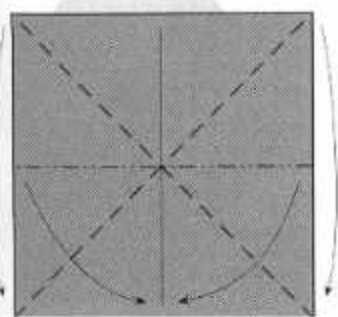
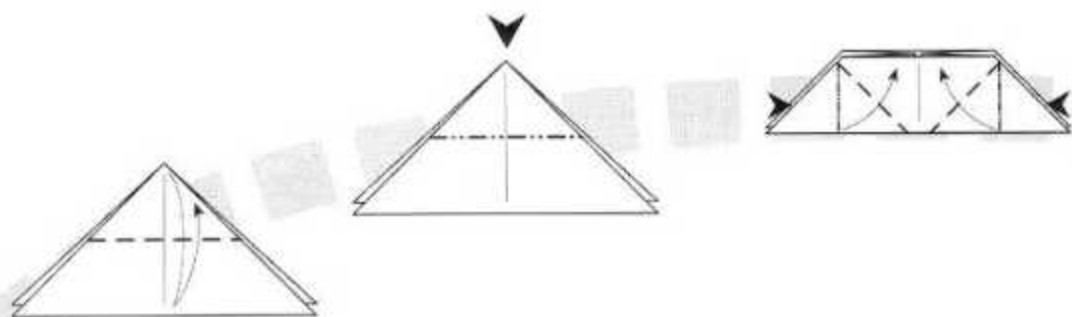
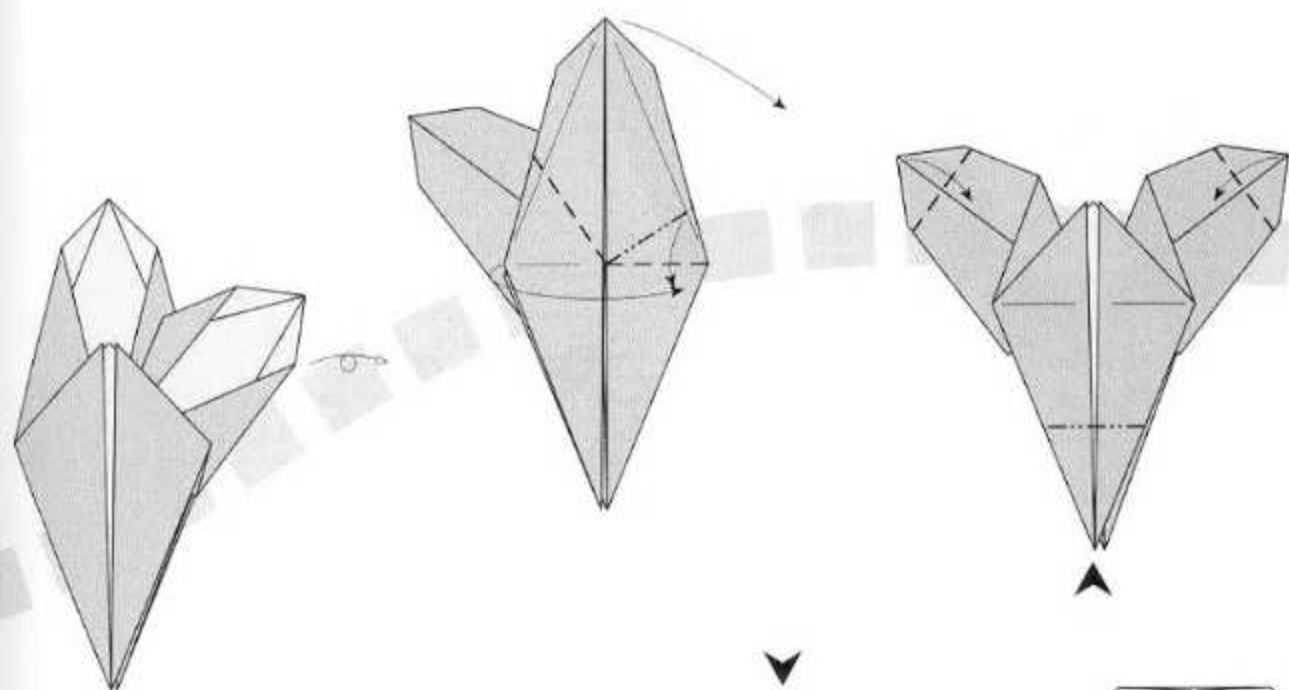
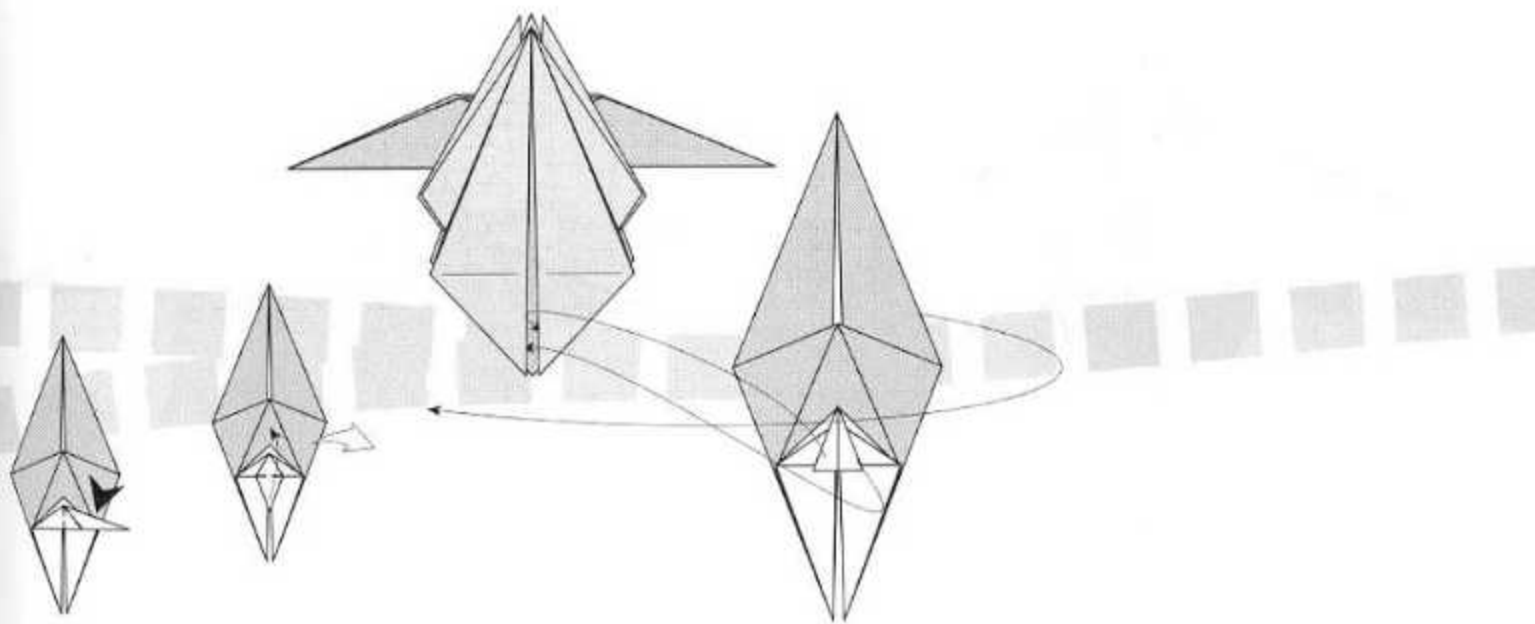

● Negro
○ Blanco

■ 5 cm

● Negro
○ Naranja

■ 5 cm



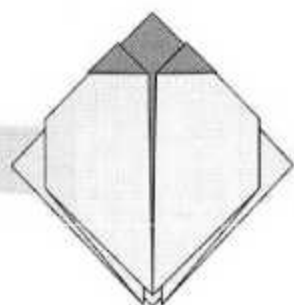
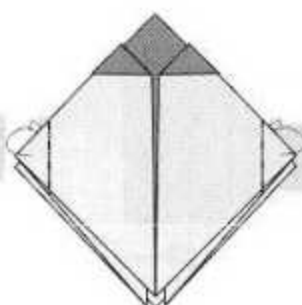
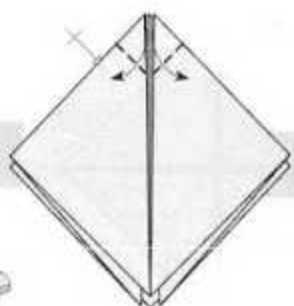
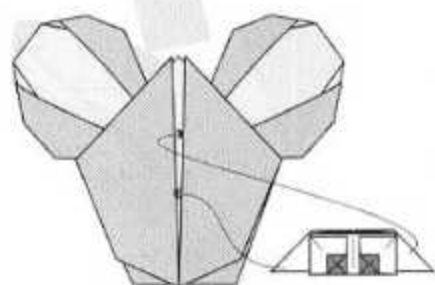
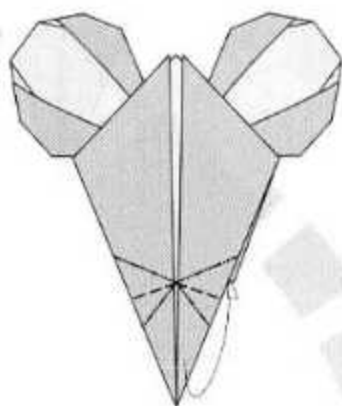
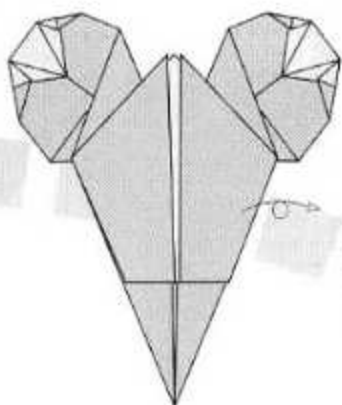
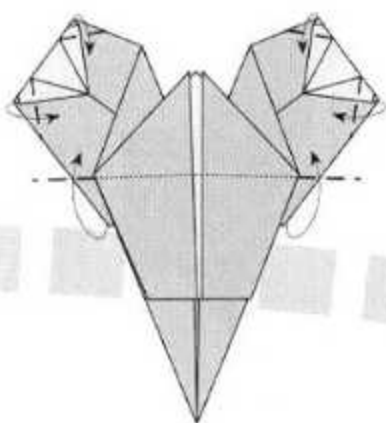
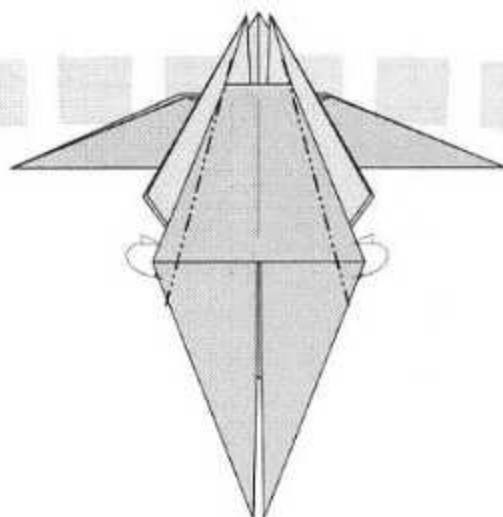
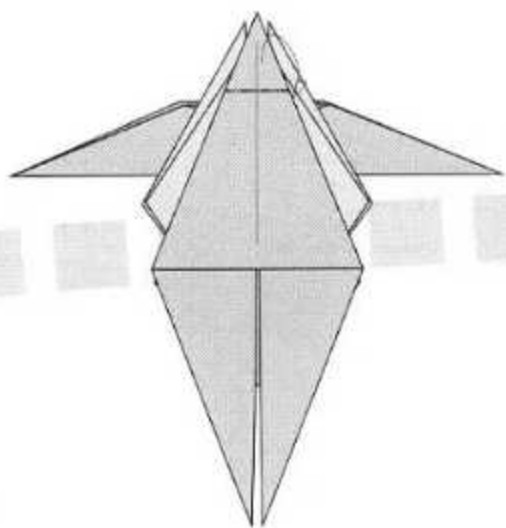

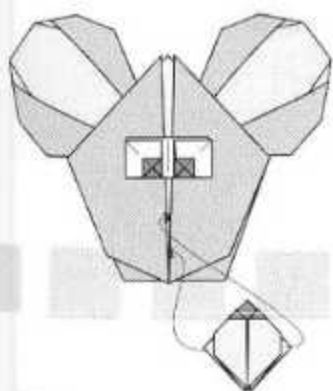
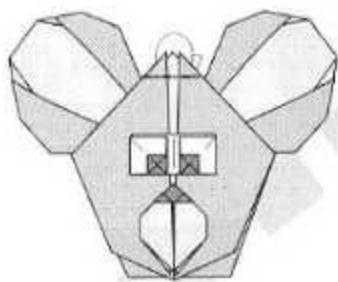
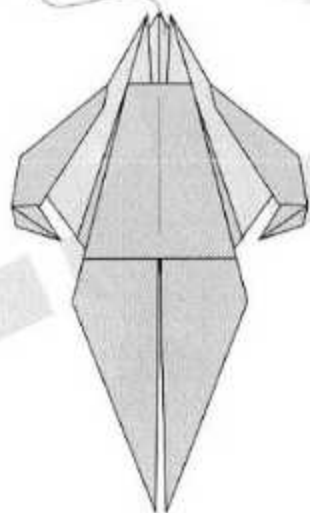
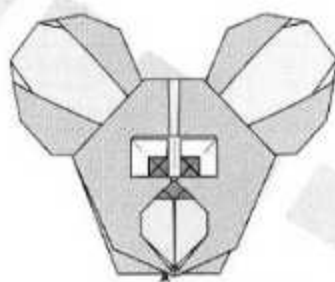
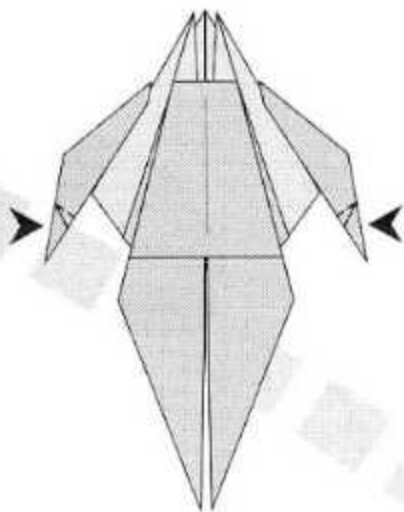
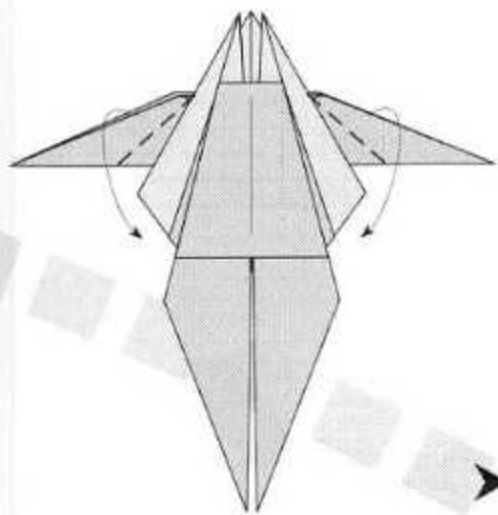

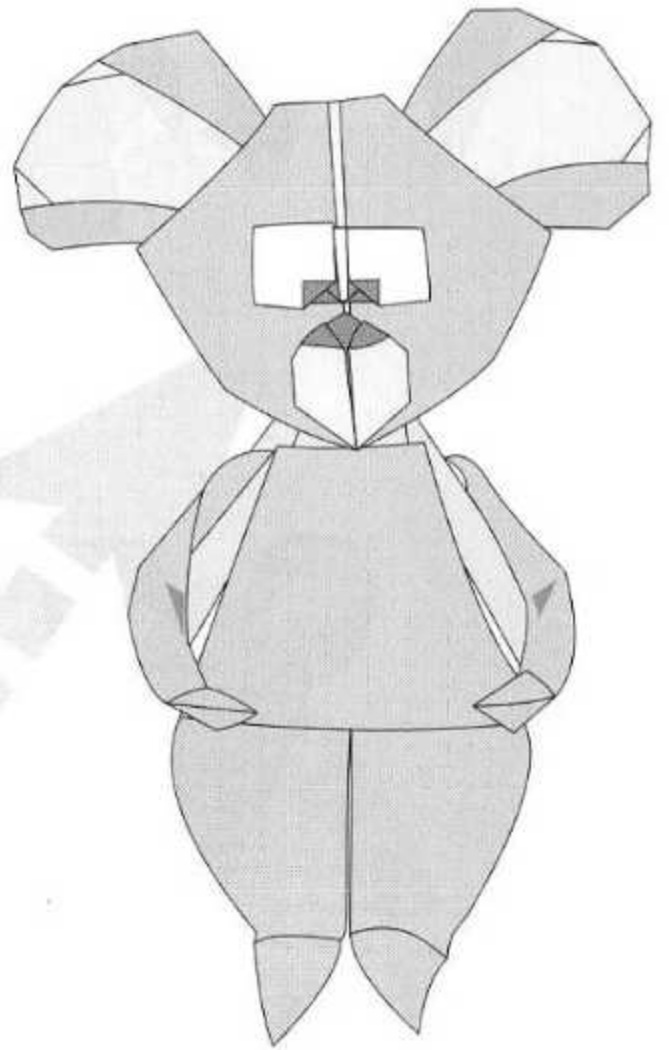
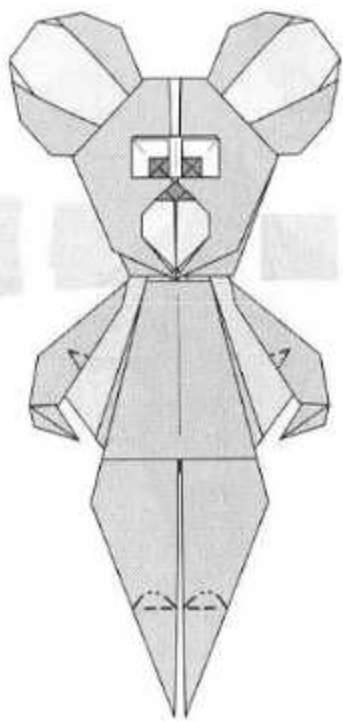

| Página (Desarr.) | Pieza nº | Cantidad | Porción | COLORES | | Tamaño original | Tamaño 3/10 | Tamaño 2/5 | Tamaño 3/5 |
|---------------------|----------|----------|---------|---------|---------|-----------------|--------------|--------------|---------------|
| | | | | Anverso | Reverso | 20 cm alto | 6 cm alto | 8 cm alto | 12 cm alto |
| | | | | | | Lado (cm) = | Lado (cm) = | Lado (cm) = | Lado (cm) = |
| 82 | 1 | 1 | Cuerpo | Neutro | Naranja | 30 | 9 | 12 | 18 |
| 82 | 2 | 1 | Rabo | Neutro | Naranja | 15 | 4,5 | 6 | 9 |
| 82 | 3 | 1 | Patas | Neutro | Naranja | 20 | 6 | 8 | 12 |
| 83 | 4 | 1 | Brazos | Neutro | Naranja | 20 | 6 | 8 | 12 |
| 84 | 5 | 1 | Cara | Negro | Naranja | 20 | 6 | 8 | 12 |
| 85 | 6 | 1 | Corbata | Neutro | Azul | 3,75 | 1,125 | 1,5 | 2,25 |
| 86 | 7 | 1 | Ojos | Negro | Bianco | 5 | 1,5 | 2 | 3 |
| 87 | 8 | 1 | Boca | Neutro | Crema | 10 | 3 | 4 | 6 |



Plegado por: Halle

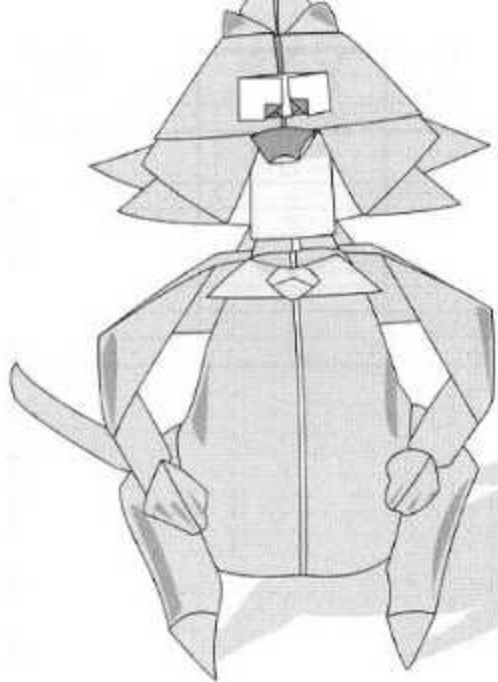

Utilizando las medidas recomendadas, se obtiene un modelo final de 20 cms.

| | |
|-----------------------------|-----------|
| Autor: | Halle |
| Nivel de dificultad: | Medio |
| Número de piezas: | 8 |
| Forma de las piezas: | Cuadrados |

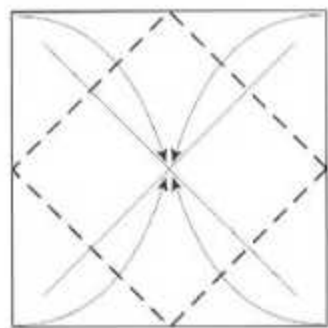

● Naranja □ 30 cm
30 cm

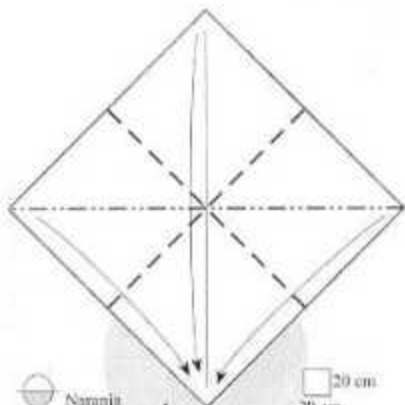
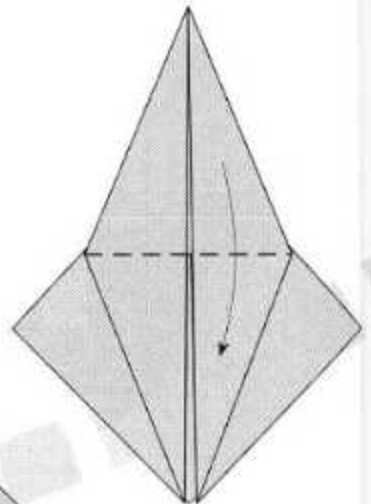
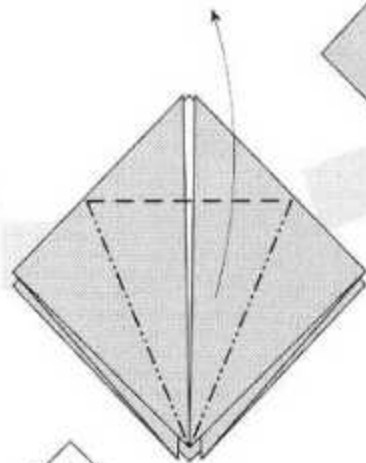
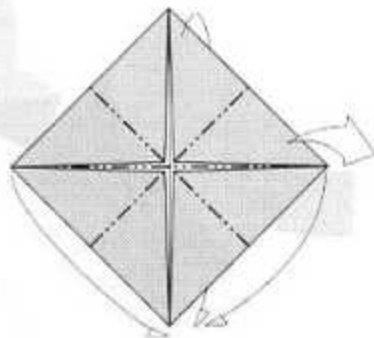

● Naranja □ 20 cm
20 cm

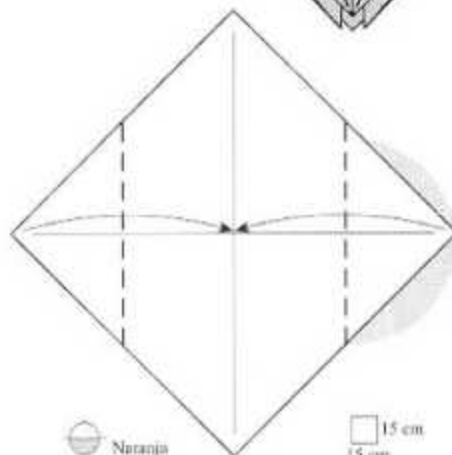

● Naranja □ 15 cm
15 cm

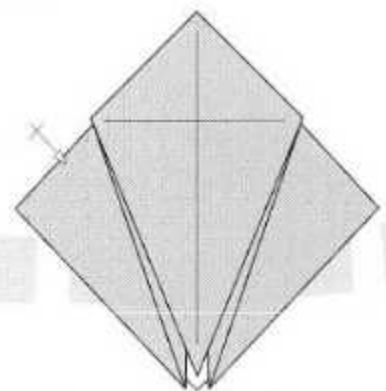
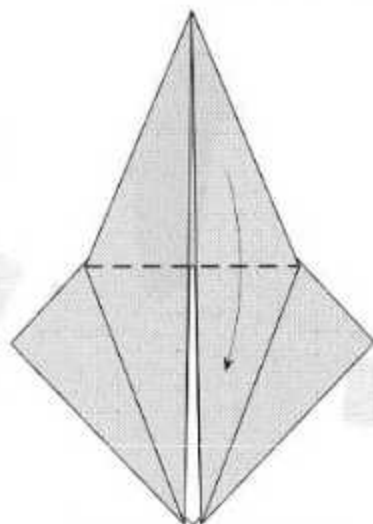
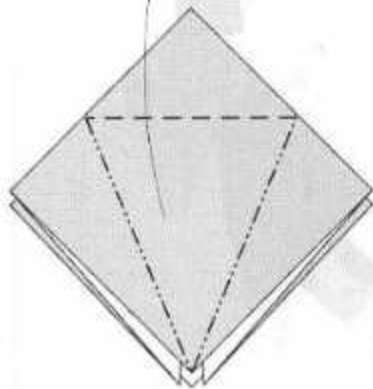
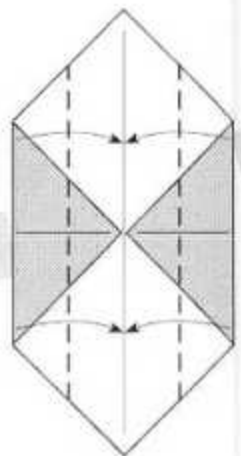

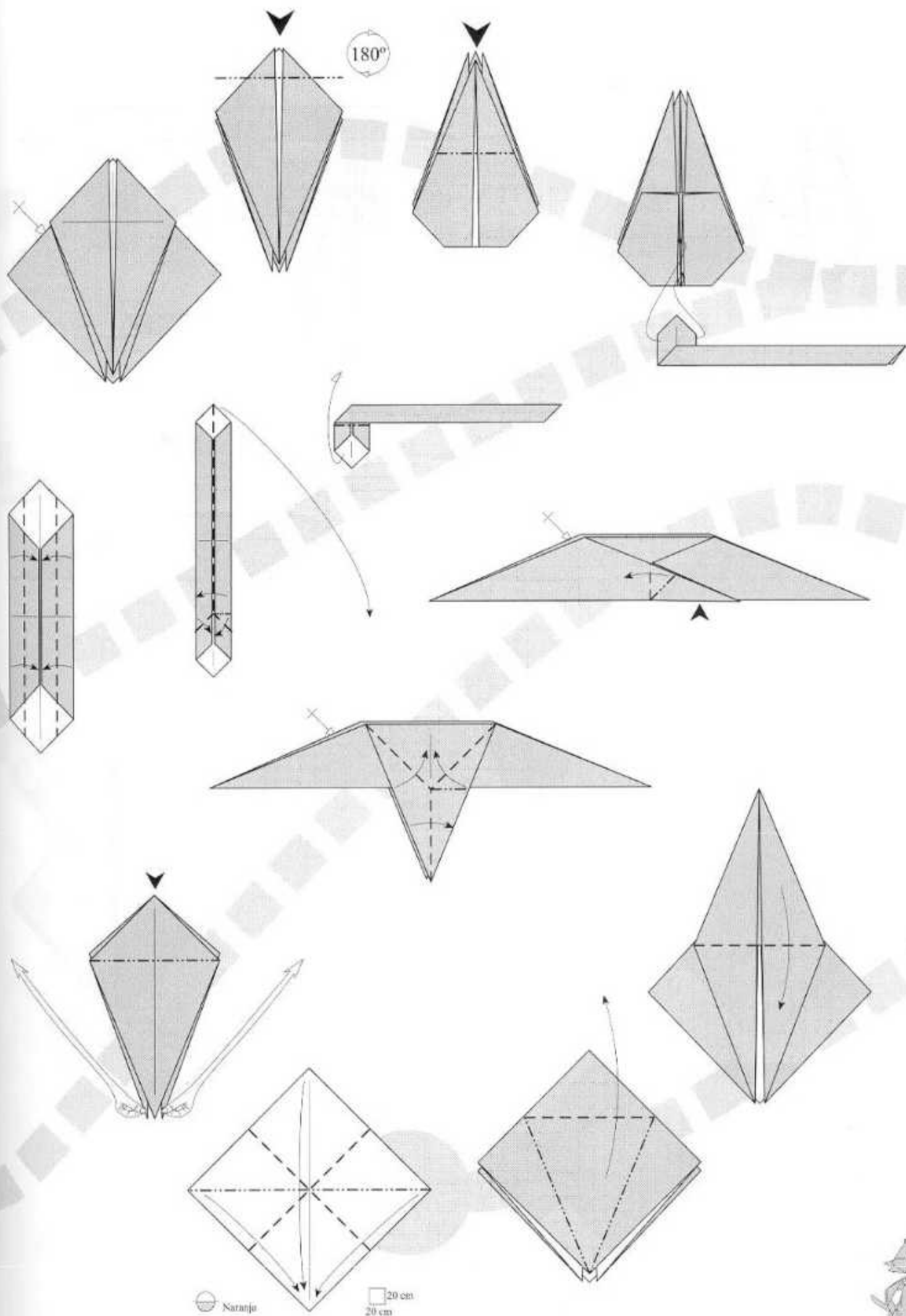

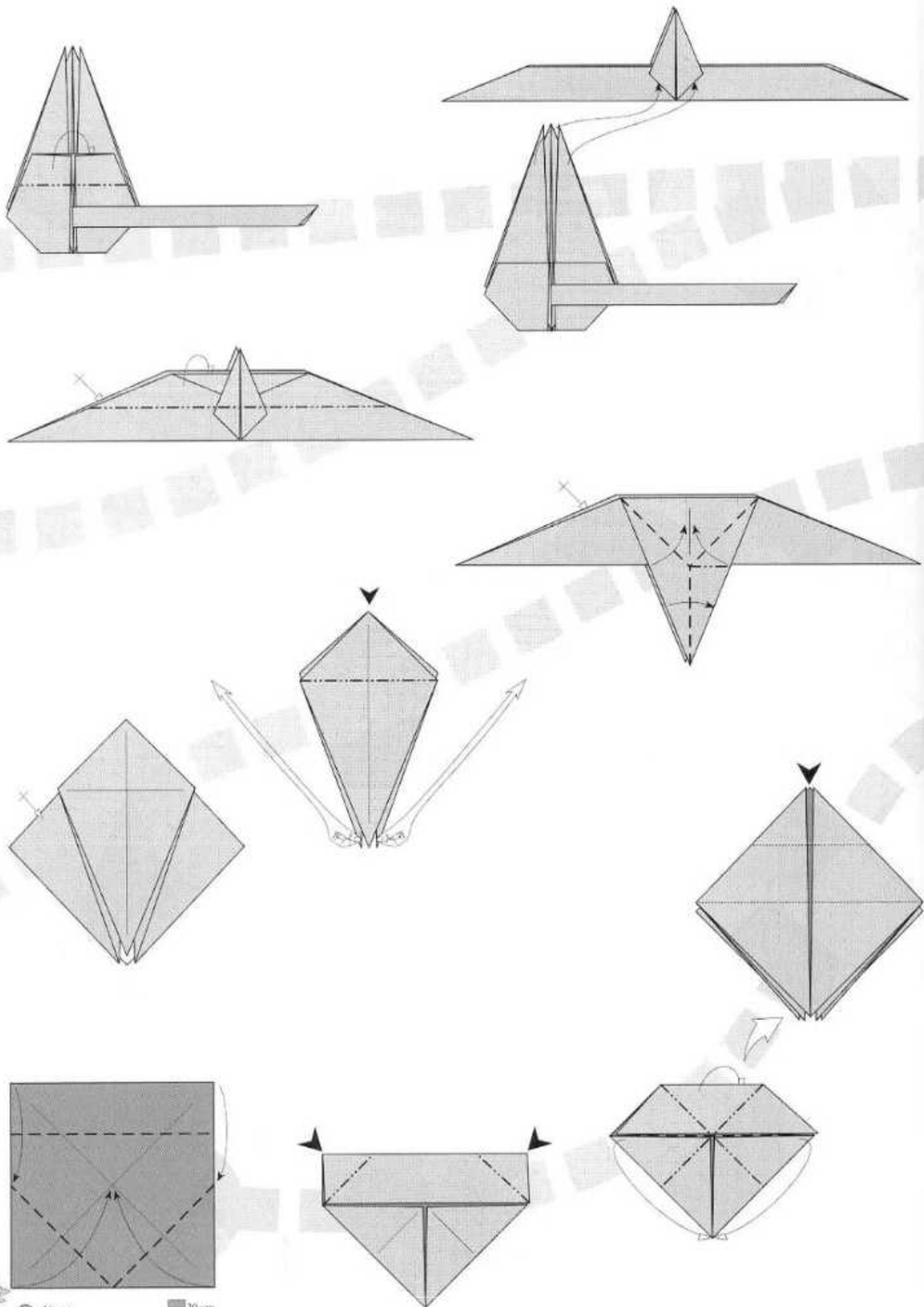

● Negro
● Naranja

■ 20 cm
■ 20 cm

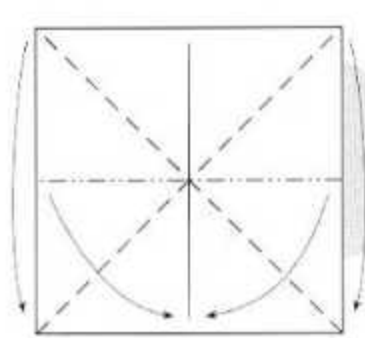
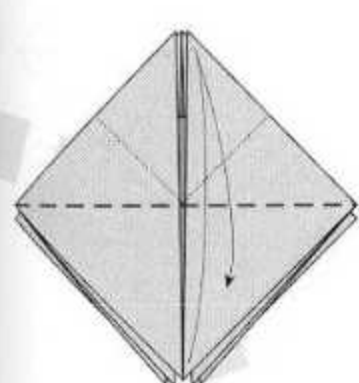
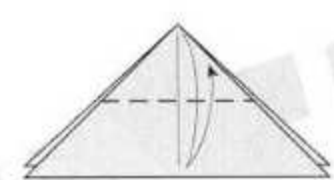
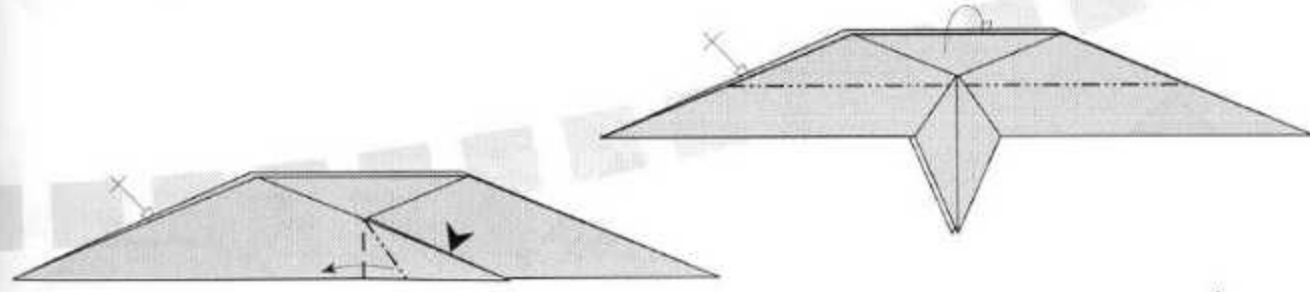
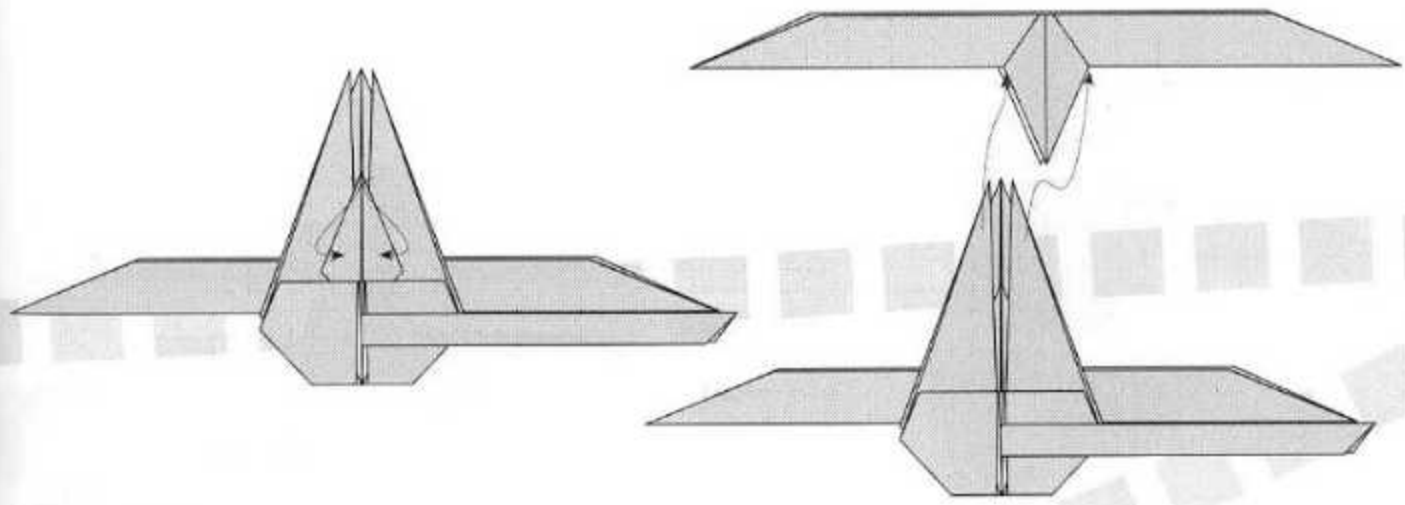

⊖ Anil

1,75 cm
3,75 cm

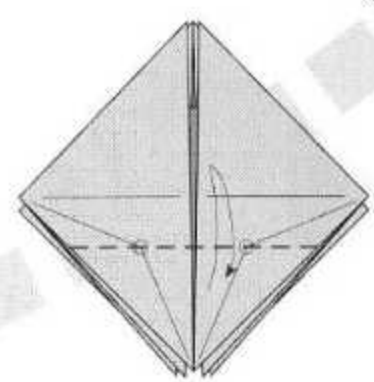
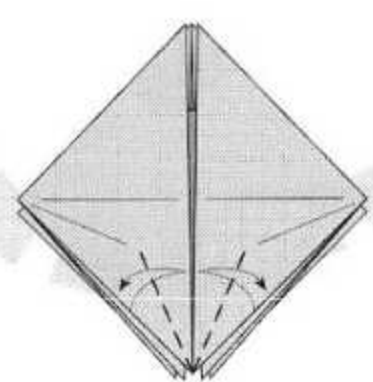
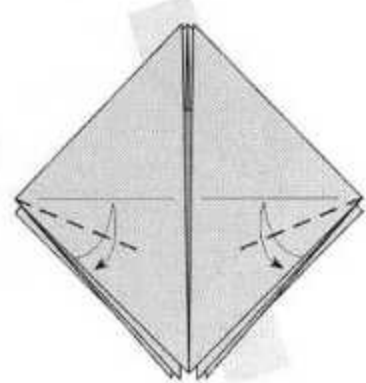
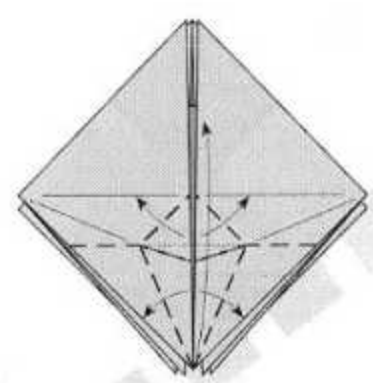

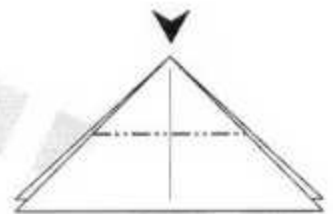
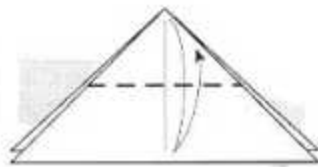
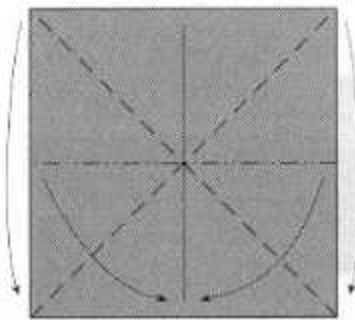
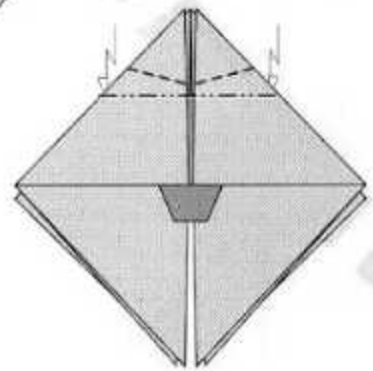
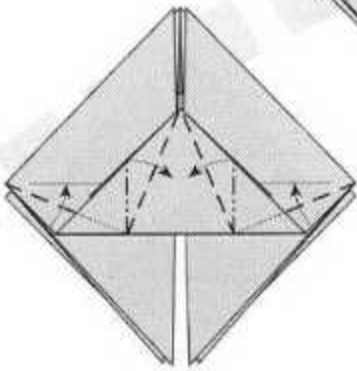
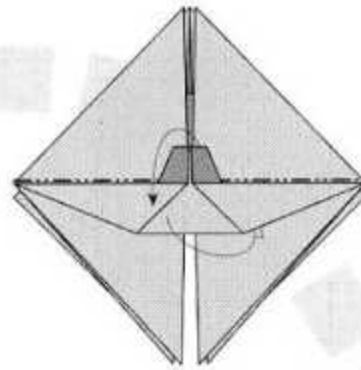
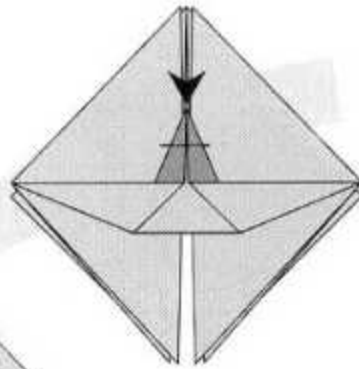
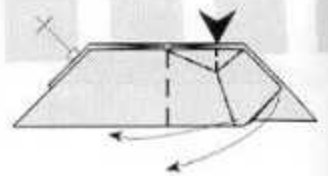
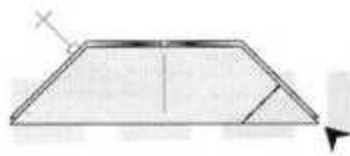
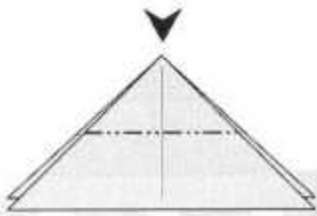
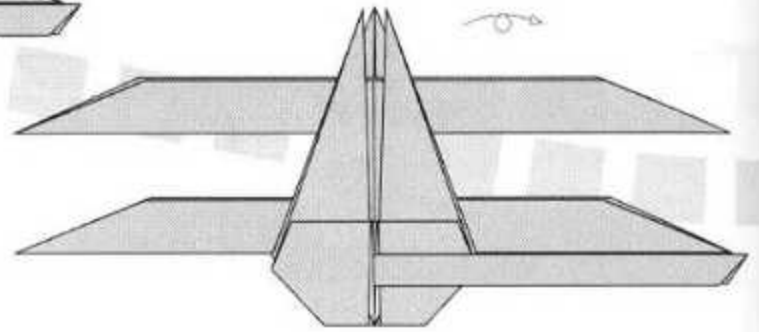
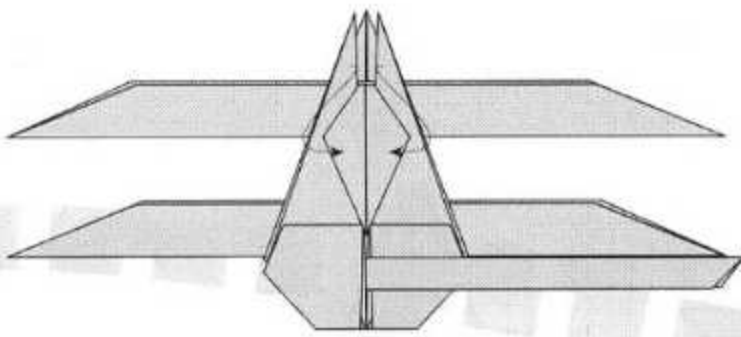

● Negro
○ Blanco

■ 5 cm
□ 5 cm



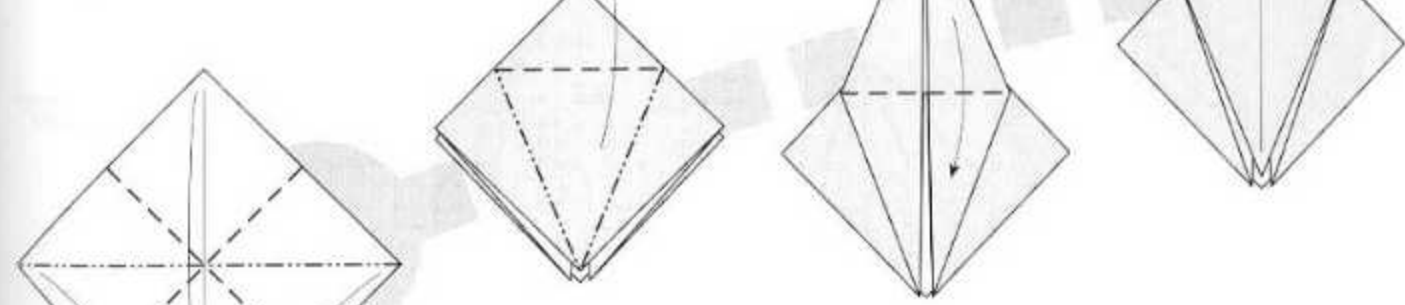
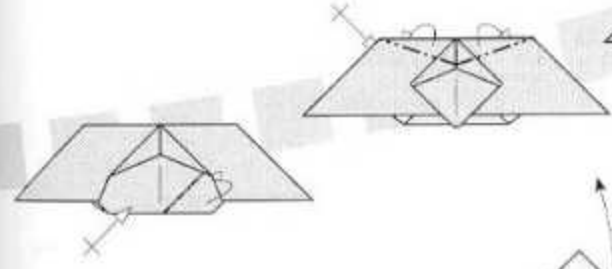
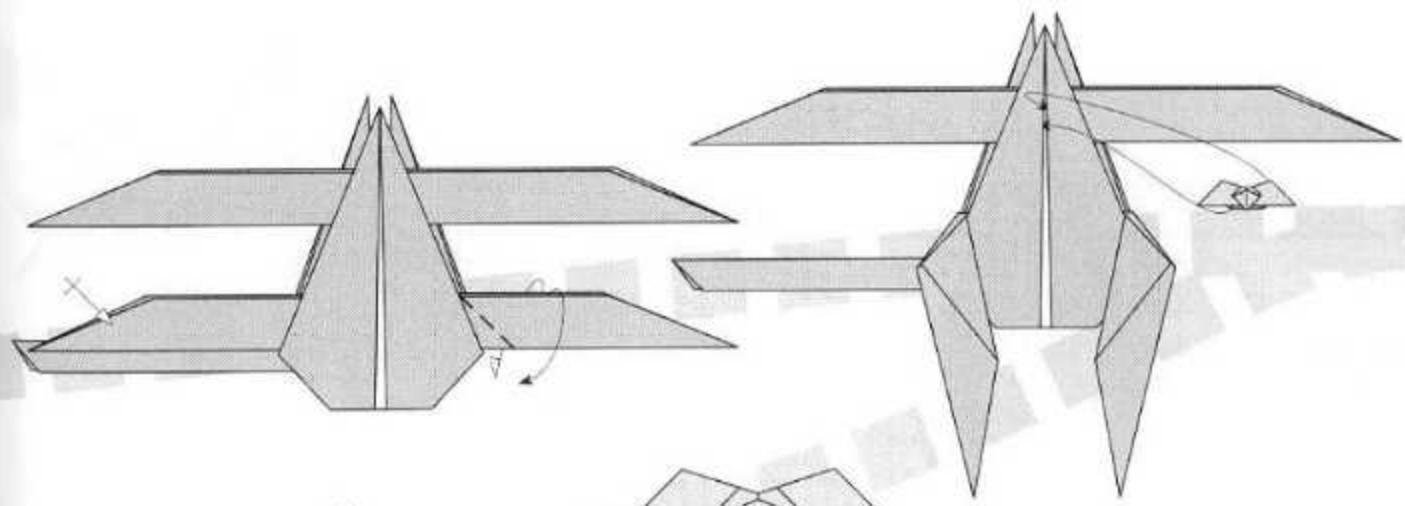

10 cm
10 cm

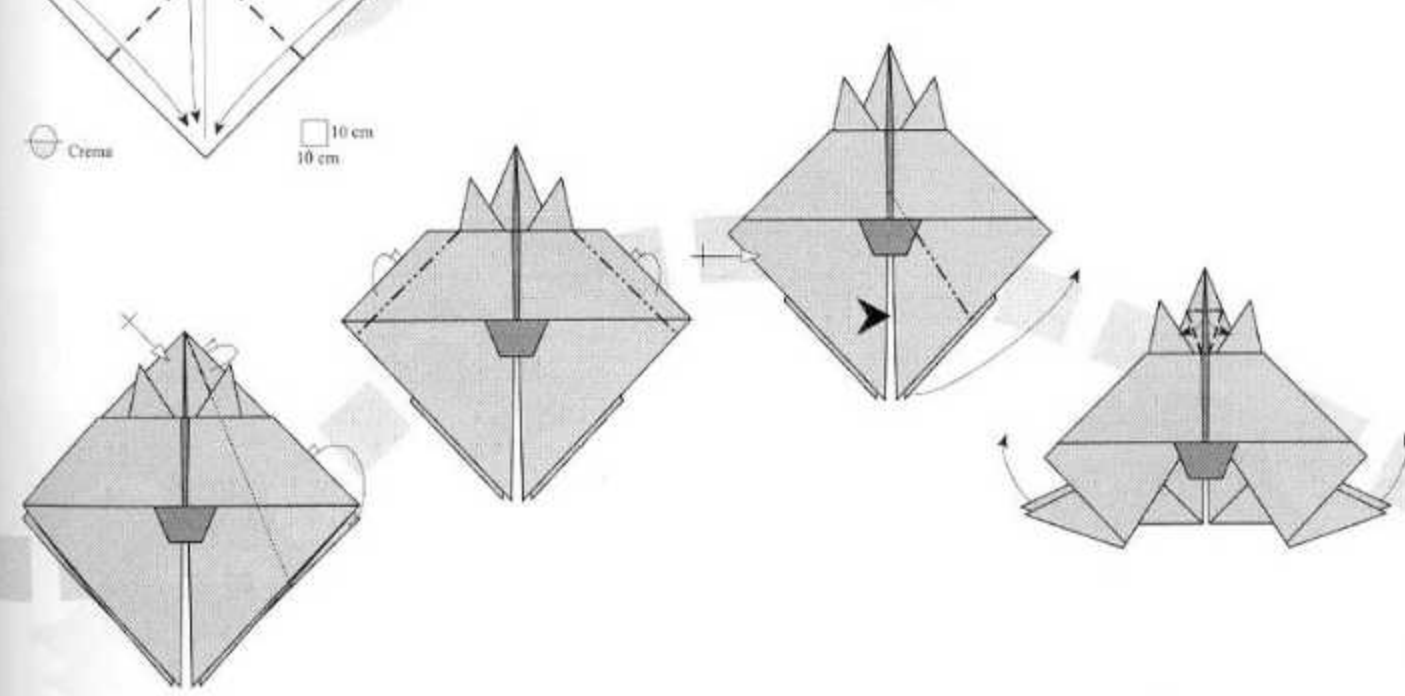

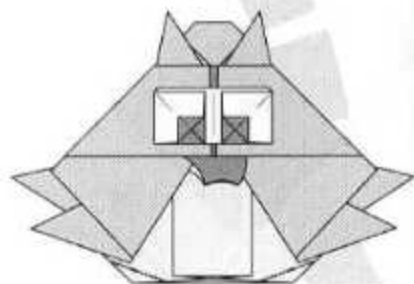
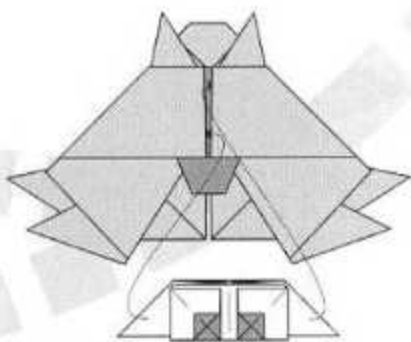
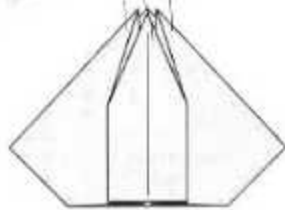
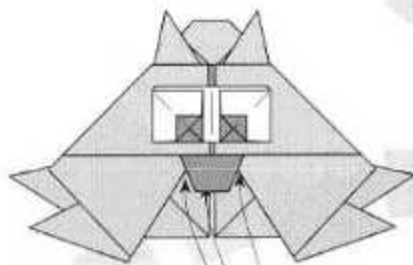
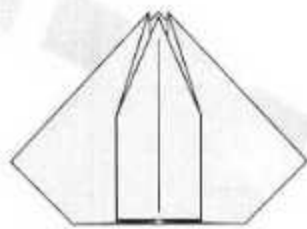
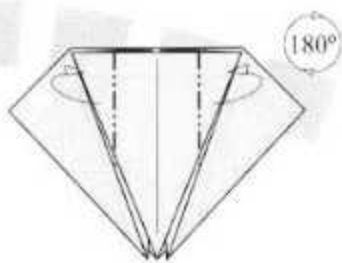
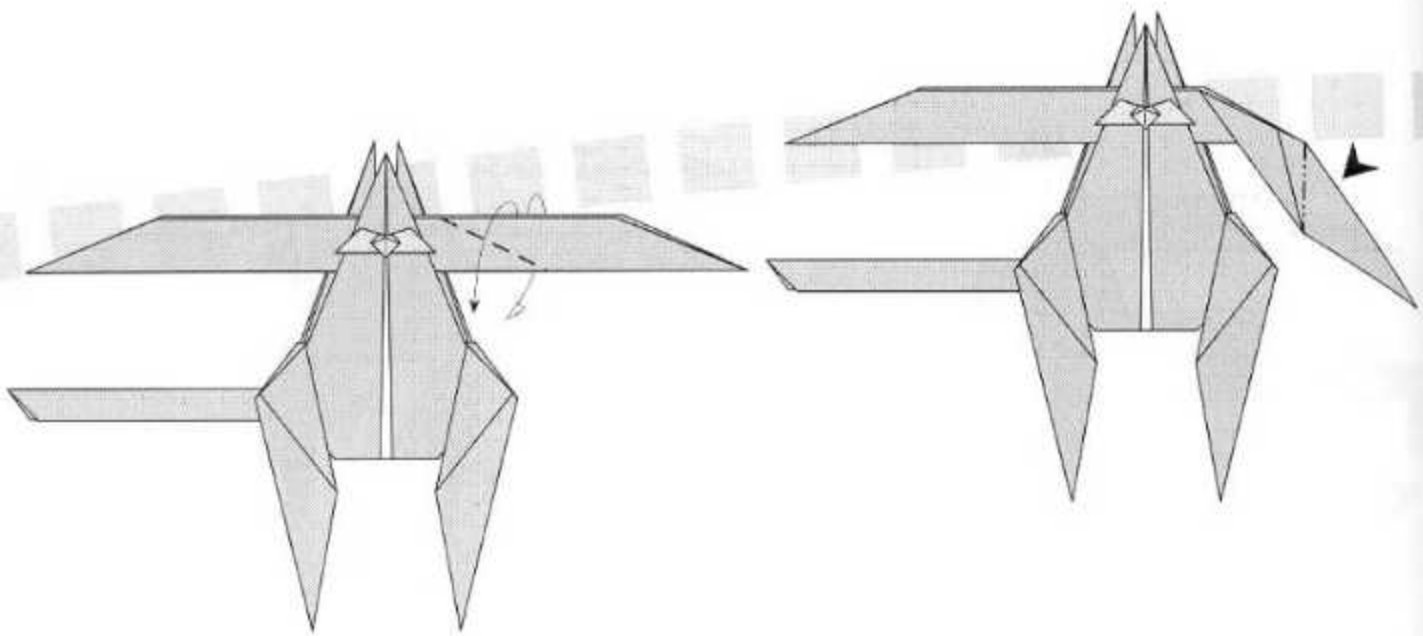

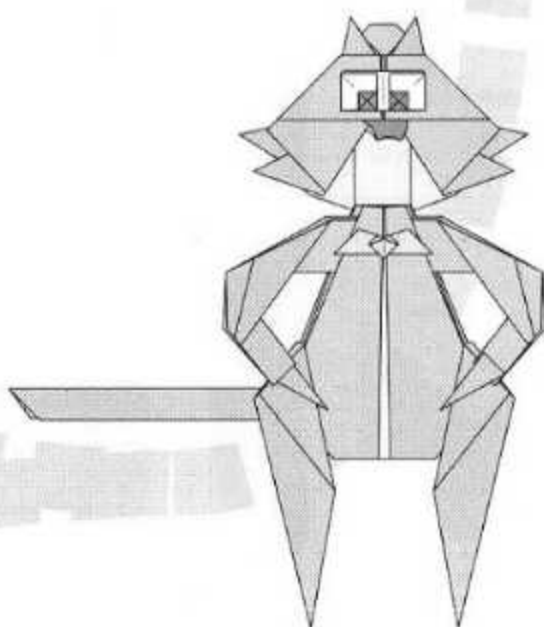
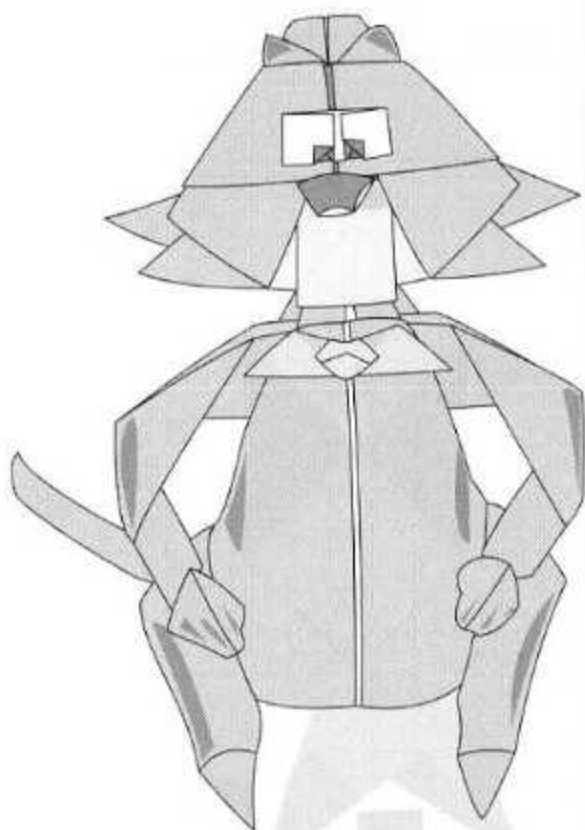
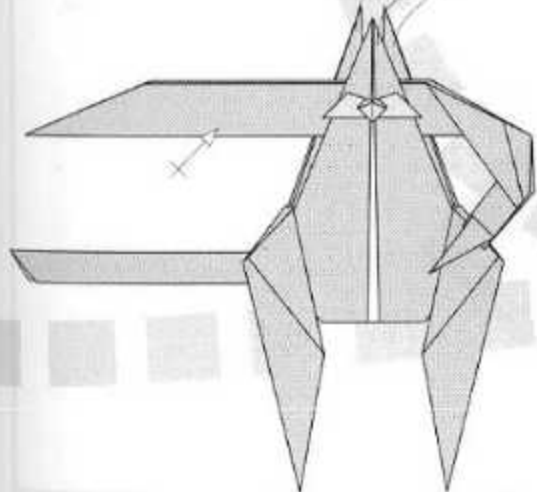
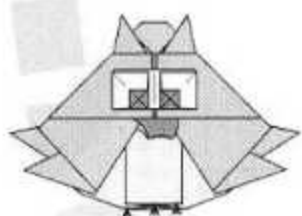
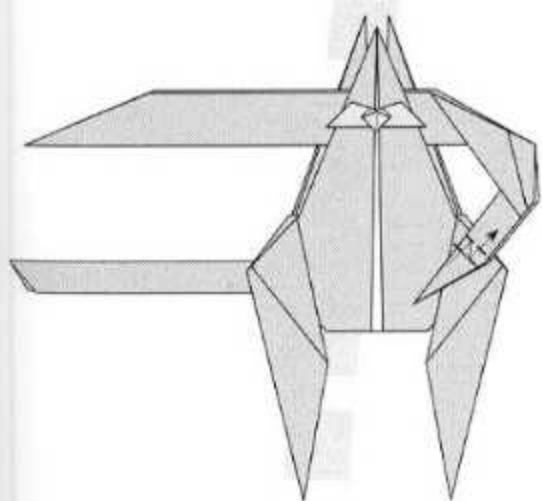
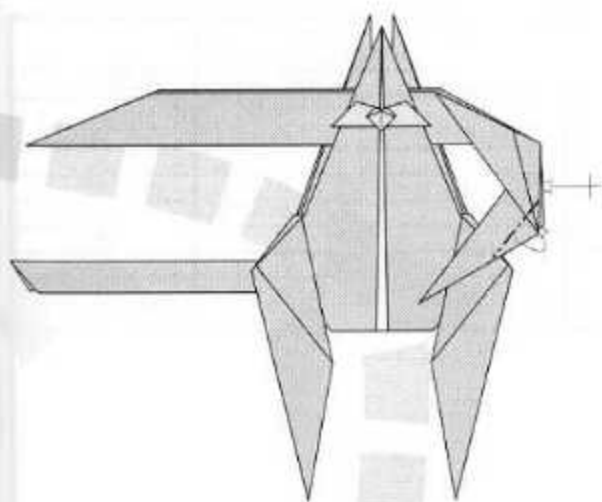

| Página (Desarr.) | Pieza nº | Cantidad | Porción | COLORES | | Tamaño original | Tamaño 3/10 | Tamaño 2/5 | Tamaño 3/5 |
|---------------------|----------|----------|----------------|---------|---------|-----------------|--------------|--------------|---------------|
| | | | | Anverso | Reverso | 20 cm alto | 6 cm alto | 8 cm alto | 12 cm alto |
| | | | | | | Lado (cm) = | Lado (cm) = | Lado (cm) = | Lado (cm) = |
| 91 | 1 | 2 | Miembros | Bianco | Negro | 20 | 6 | 8 | 12 |
| 91 | 2 | 1 | Medio cuerpo | Negro | Bianco | 15 | 4,5 | 6 | 9 |
| 91 | 3 | 1 | Medio cuerpo | Negro | Bianco | 15 | 4,5 | 6 | 9 |
| 93 | 4 | 1 | Base cara | Rosa | Rosa | 20 | 6 | 8 | 12 |
| 93 | 5 | 2 | Manos | Neutro | Rosa | 5 | 1,5 | 2 | 3 |
| 94 | 6 | 1 | Ojos | Negro | Bianco | 5 | 1,5 | 2 | 3 |
| 95 | 7 | 2 | Gafas | Neutro | Negro | 5 | 1,5 | 2 | 3 |
| 95 | 8 | 1 | Patillas gafas | Neutro | Negro | 5 | 1,5 | 2 | 3 |



Plegado por: J.A.V.I.



Utilizando las medidas recomendadas, se obtiene un modelo final de 20 cms.

| | |
|-----------------------------|------------|
| Autor: | Halle |
| Nivel de dificultad: | Medio-Alto |
| Número de piezas: | 11 |
| Forma de las piezas: | Cuadrados |

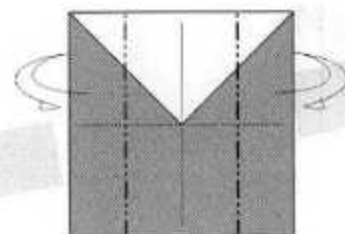
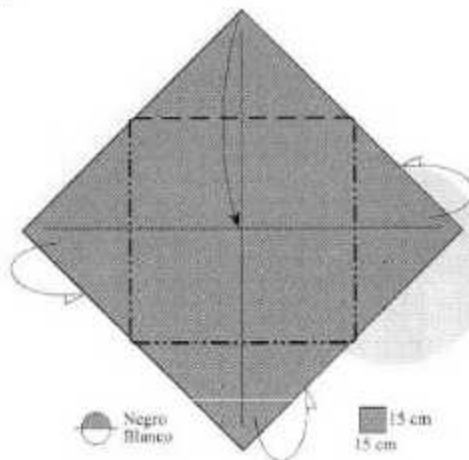
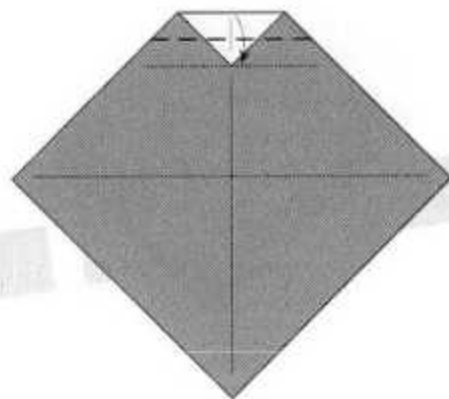
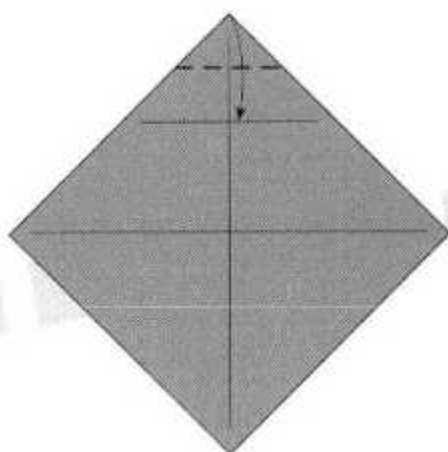
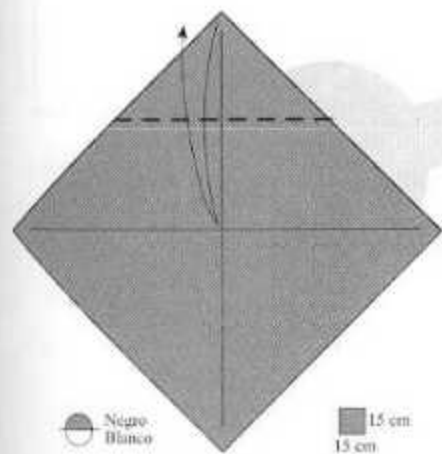
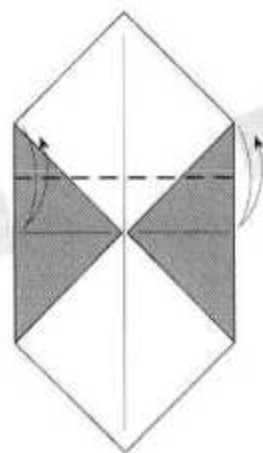
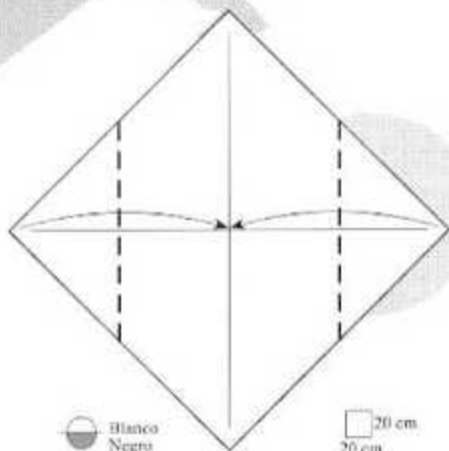

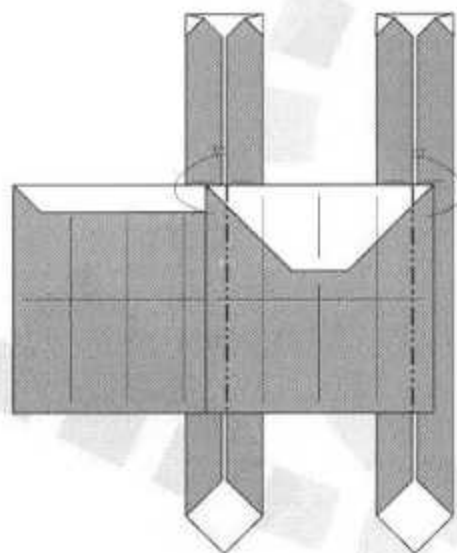
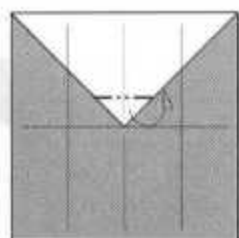
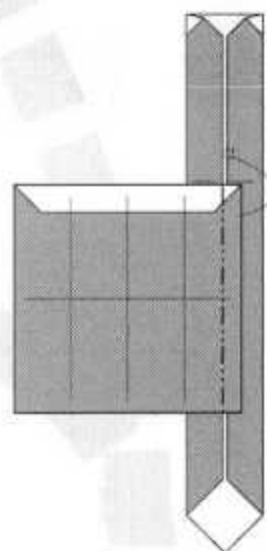
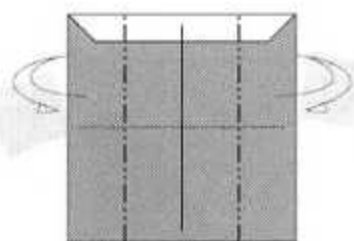
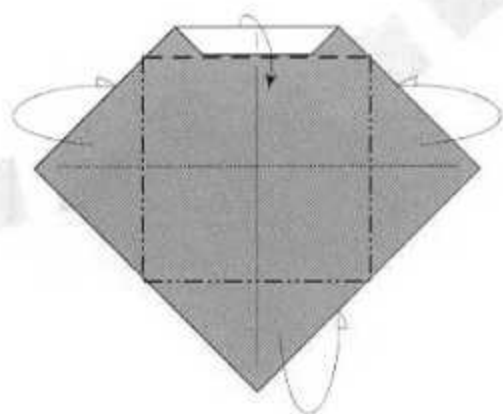
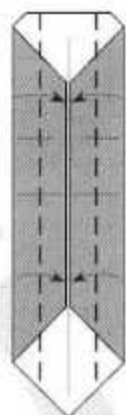
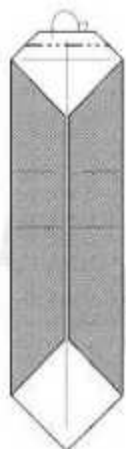
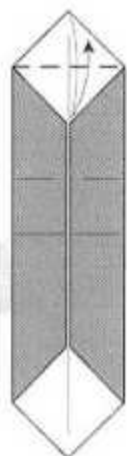
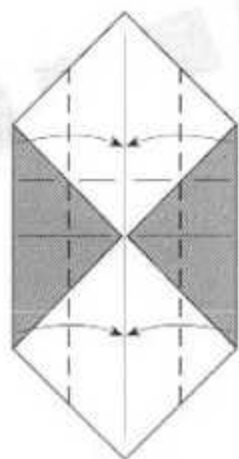

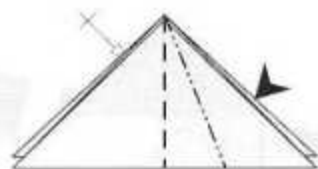
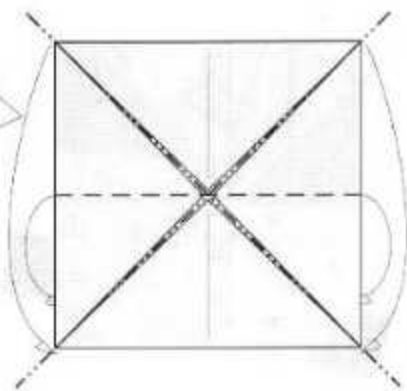
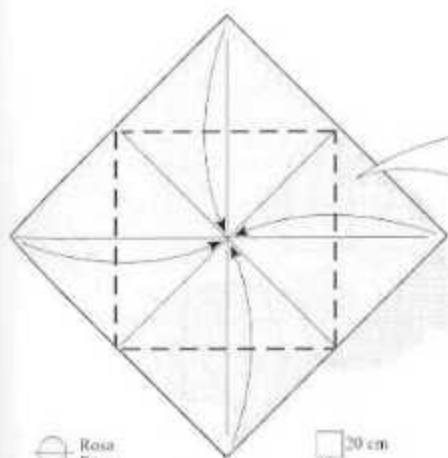

Rosa
Rosa

20 cm
20 cm

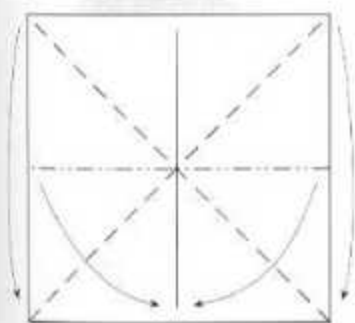
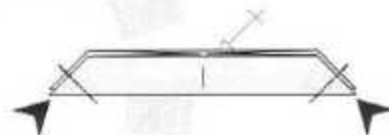
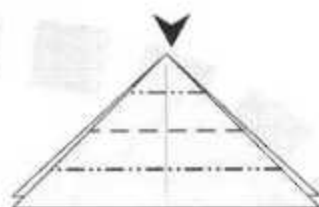
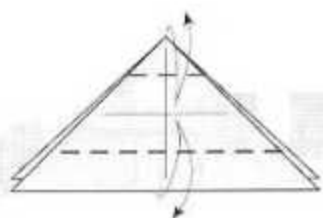
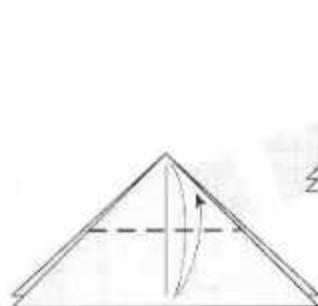

Rosa

5 cm
5 cm

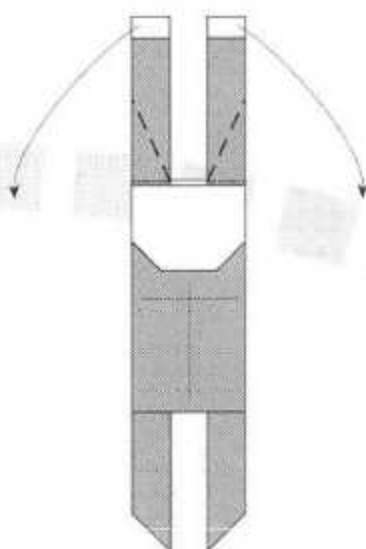
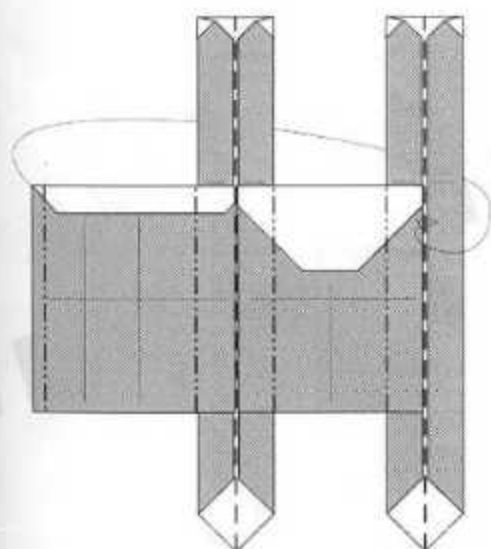

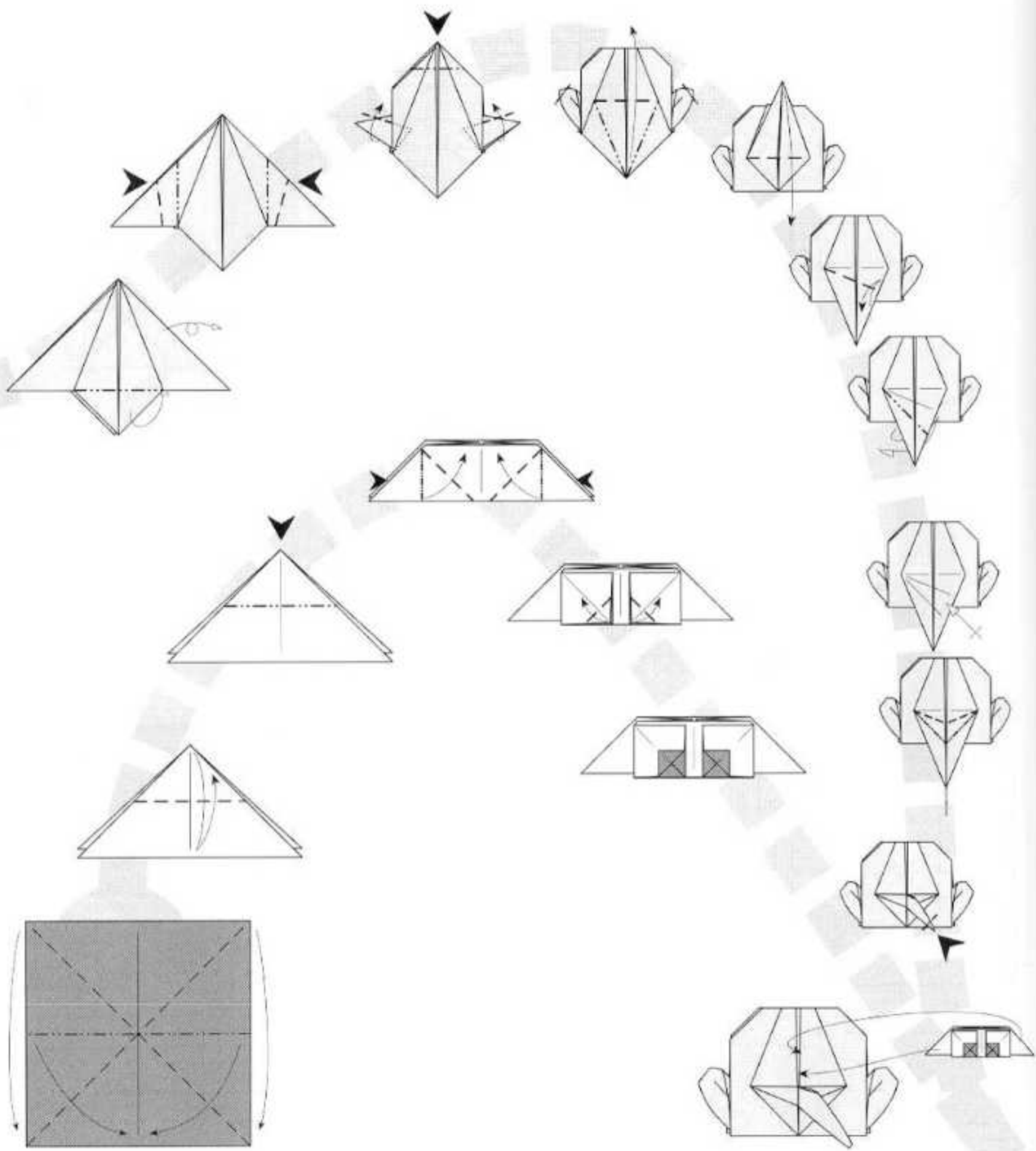

Negro
 Blanco

5 cm
 5 cm

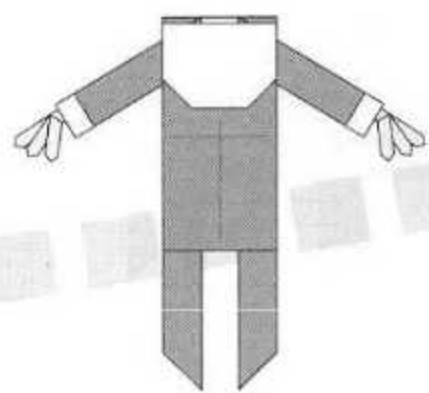
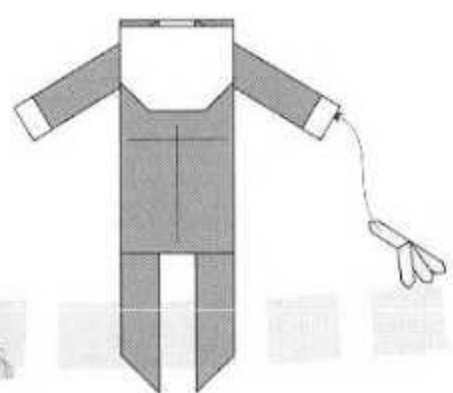

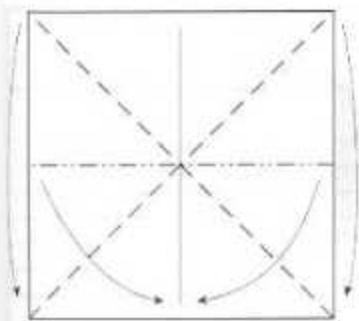

Negro

5 cm
5 cm

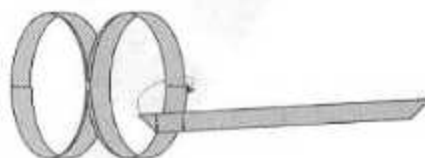
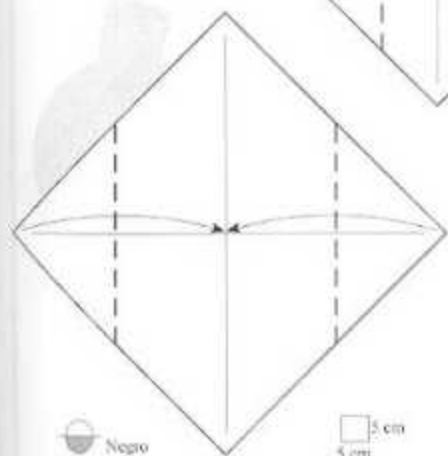
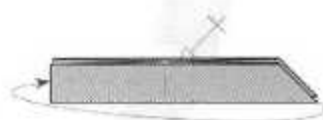
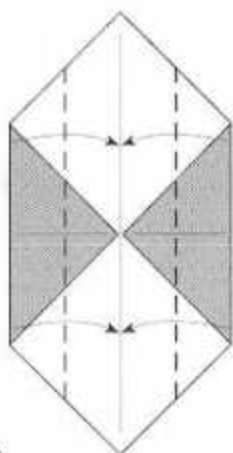
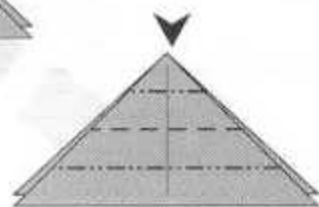
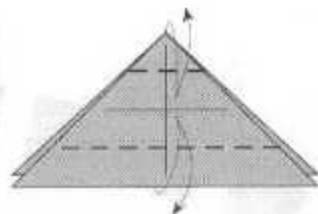
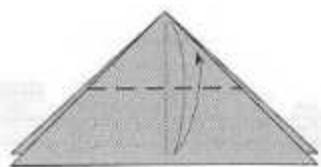

Negro

5 cm
5 cm

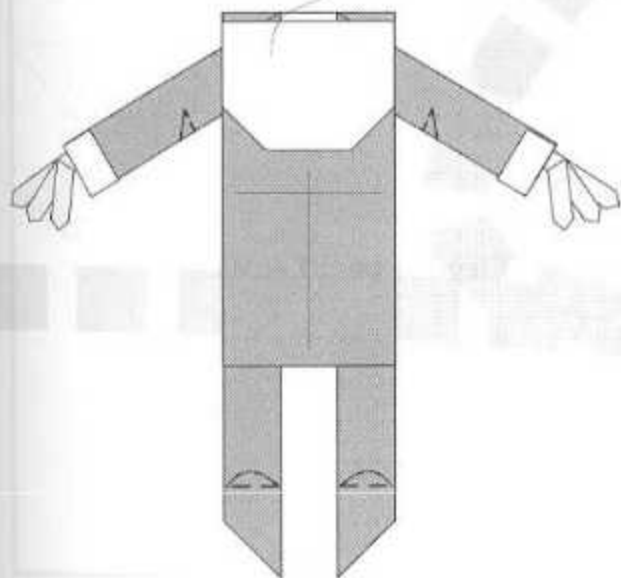
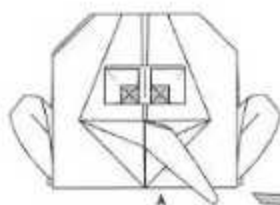
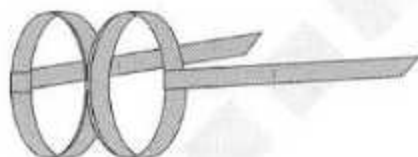

| Página (Desarr.) | Pieza nº | Cantidad | Porción | COLORES | | Tamaño original | Tamaño 3/10 | Tamaño 2/5 | Tamaño 3/5 |
|---------------------|----------|----------|---------|---------|---------|-----------------|-------------|-------------|-------------|
| | | | | Anverso | Reverso | 20 cm alto: | 6 cm alto | 8 cm alto | 12 cm alto |
| | | | | | | Lado (cm) = | Lado (cm) = | Lado (cm) = | Lado (cm) = |
| 97 | 1 | 1 | Cuerpo | Rojo | Bianco | 25 | 7,5 | 10 | 15 |
| 97 | 2 | 2 | Piernas | Rojo | Marrón | 15 | 4,5 | 6 | 9 |
| 97 | 3 | 1 | Brazos | Rosa | Bianco | 20 | 6 | 8 | 12 |
| 100 | 4 | 1 | Cara | Rosa | Rosa | 20 | 6 | 8 | 12 |
| 100 | 5 | 1 | Pelos | Neutro | Negro | 5 | 1,5 | 2 | 3 |
| 101 | 6 | 1 | Ojos | Negro | Bianco | 5 | 1,5 | 2 | 3 |
| 101 | 7 | 1 | Corbata | Neutro | Negro | 5 | 1,5 | 2 | 3 |

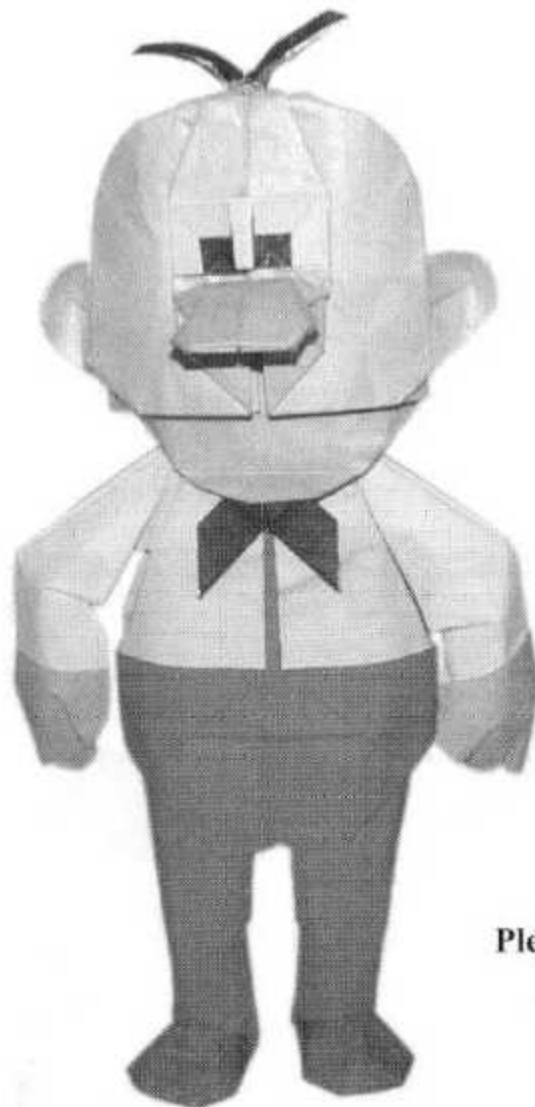

Plegado por: J.A.V.I.

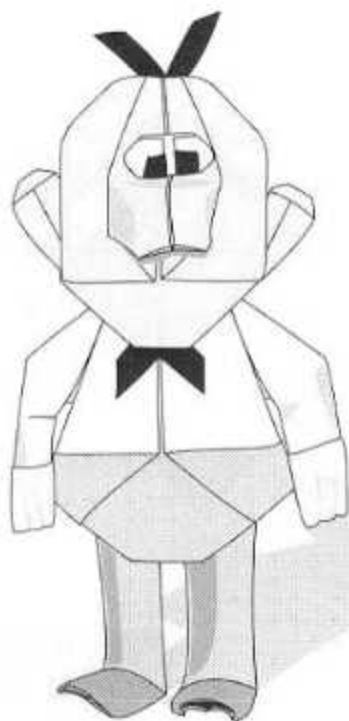

Utilizando las medidas recomendadas, se obtiene un modelo final de 20 cms.

| | |
|-----------------------------|------------|
| Autor: | Halle |
| Nivel de dificultad: | Medio-Alto |
| Número de piezas: | 8 |
| Forma de las piezas: | Cuadrados |

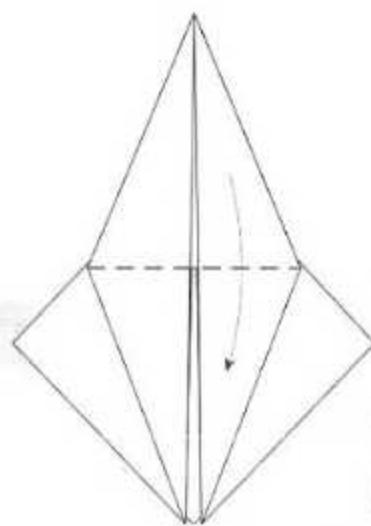
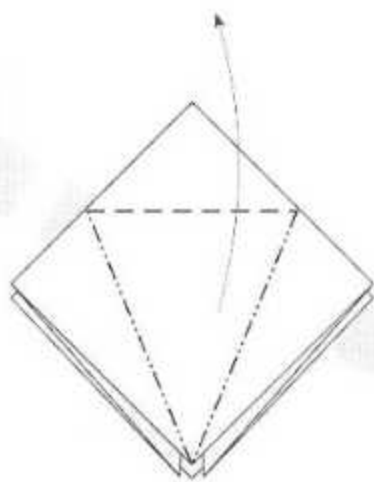
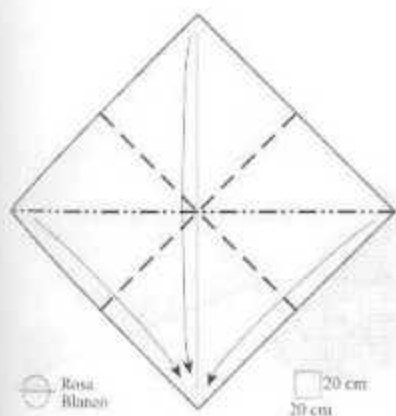
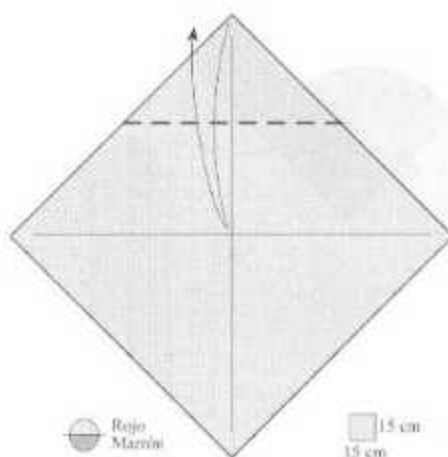
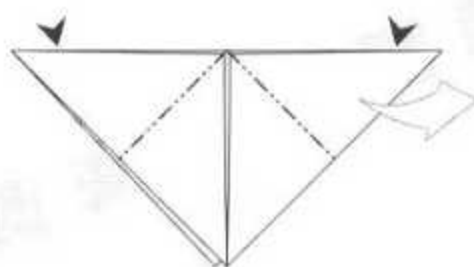
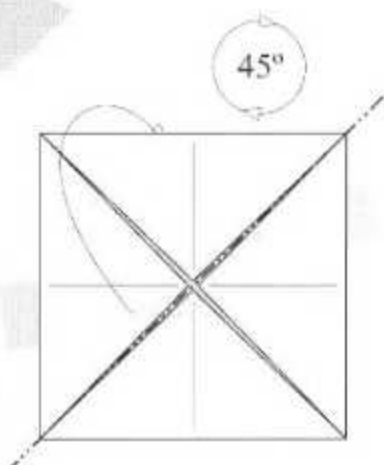
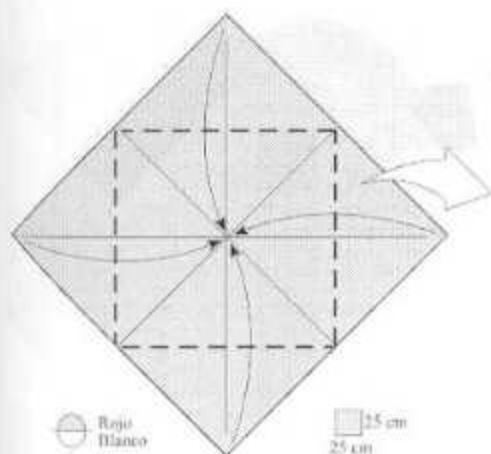

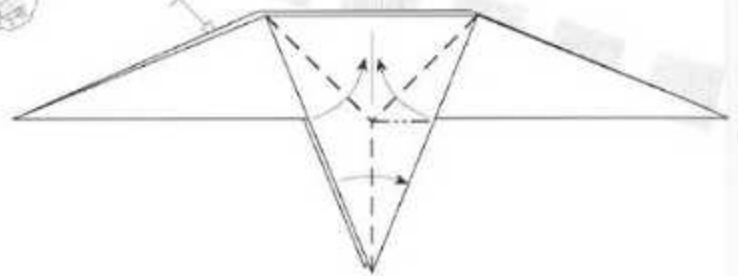
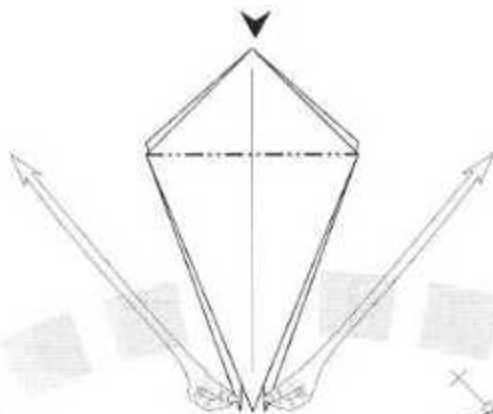
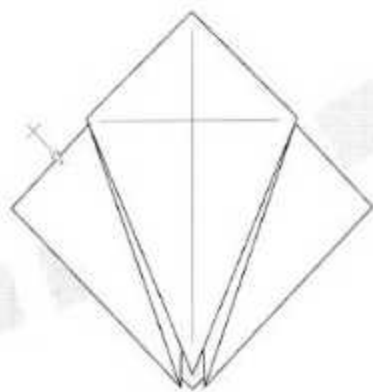
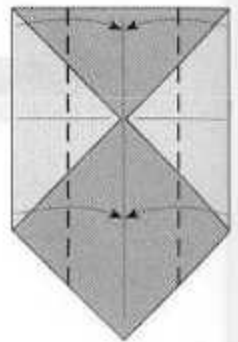
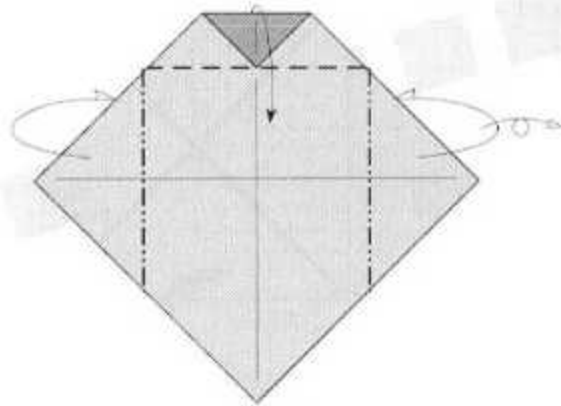
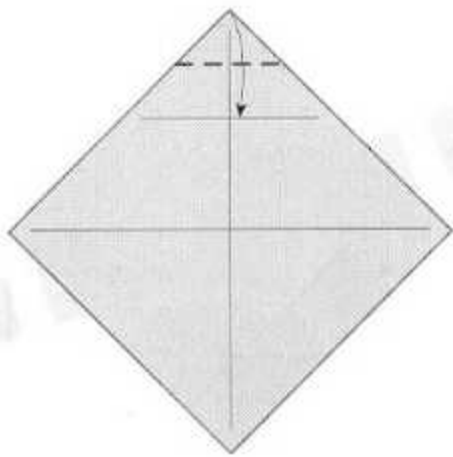
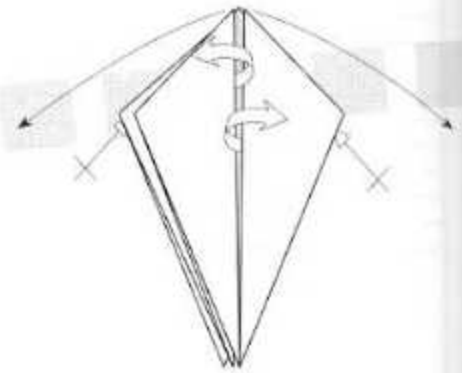
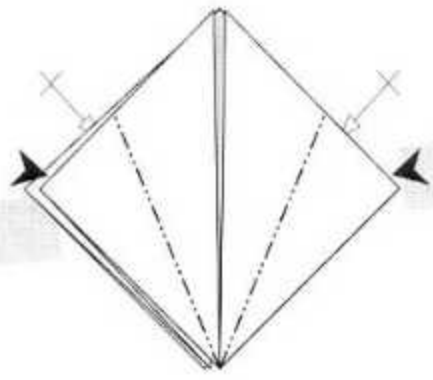
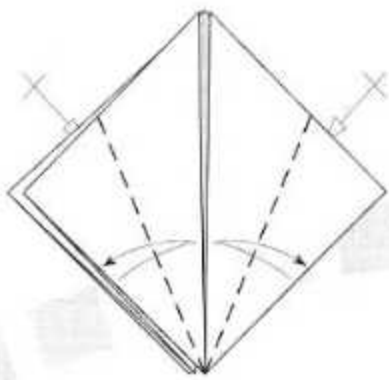

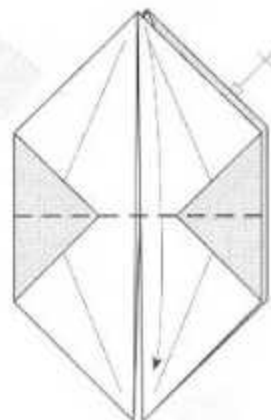
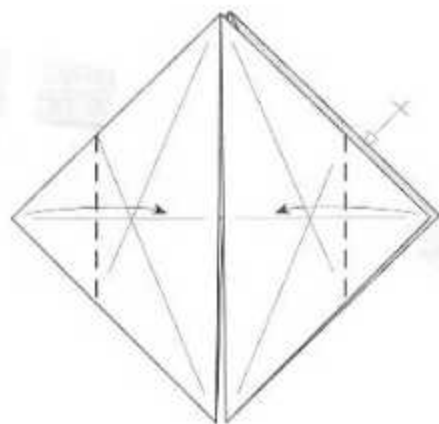
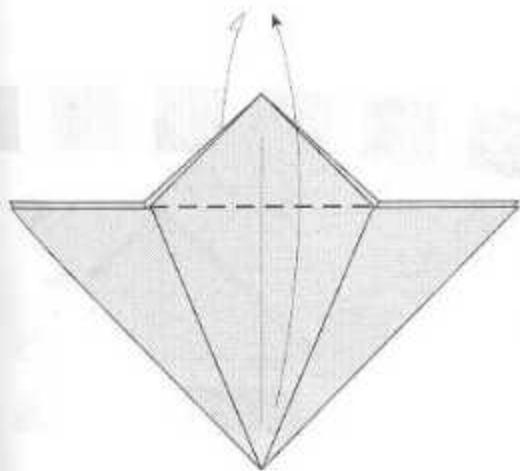

180°

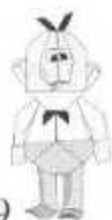
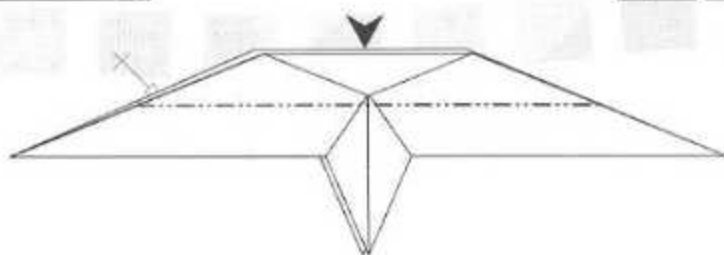
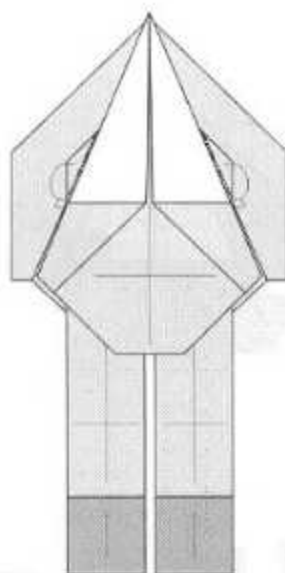
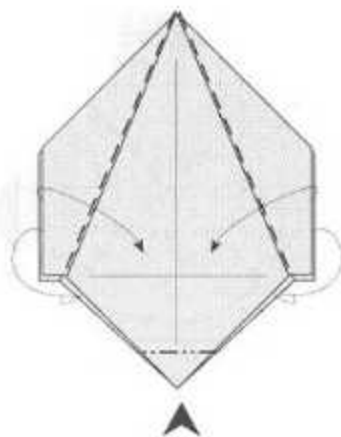
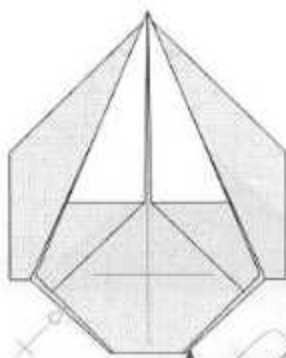
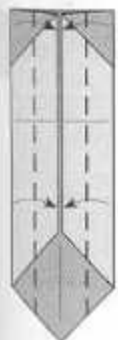

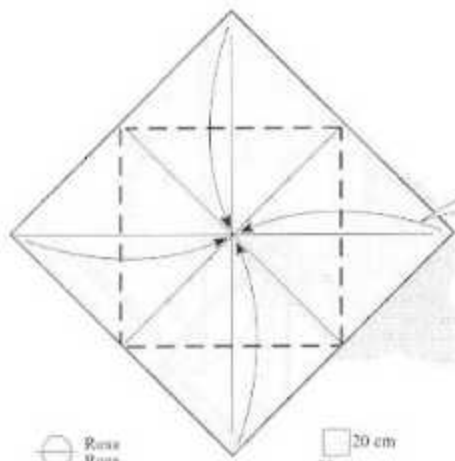

Rosa
Rosa

20 cm
20 cm

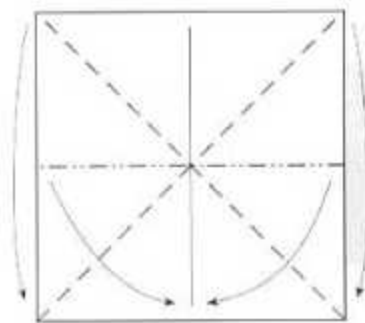
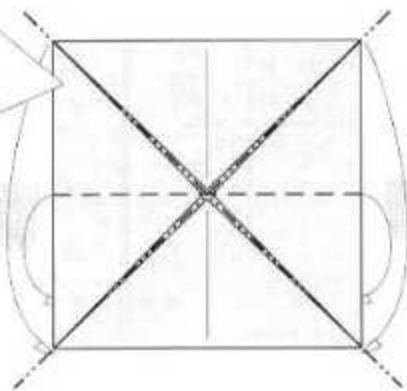

Rosa
Rosa

5 cm
5 cm

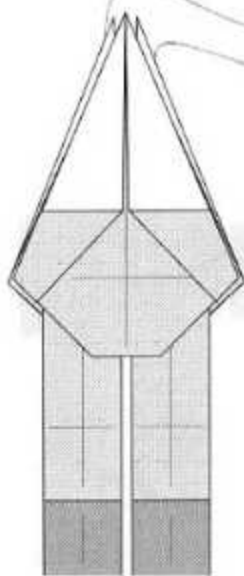
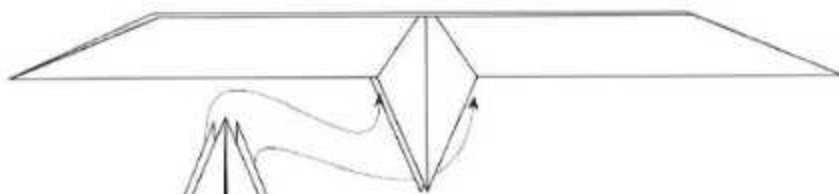
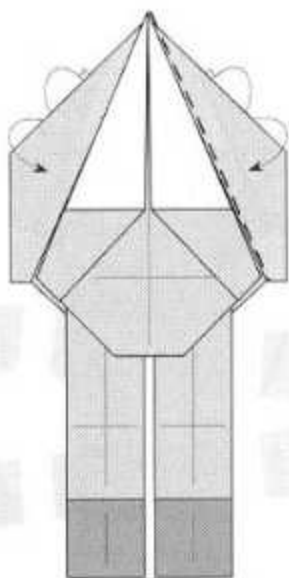
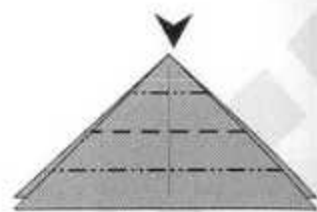
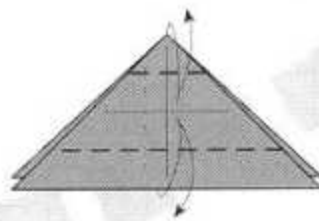
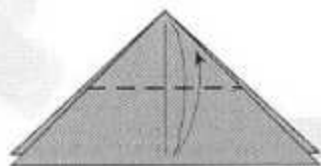

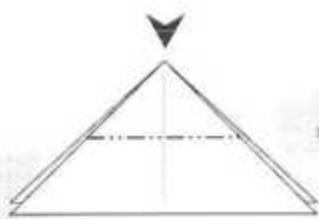
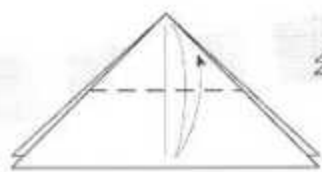
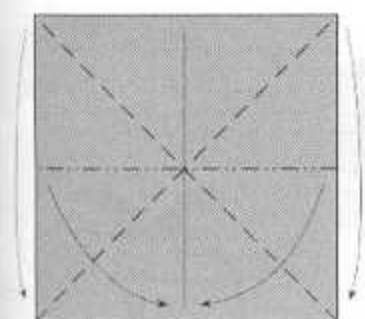
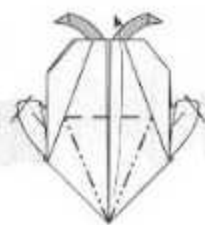
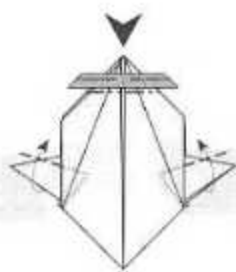
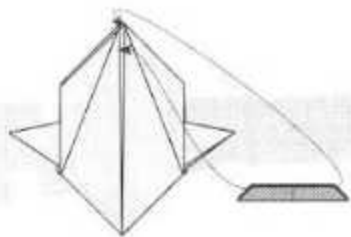
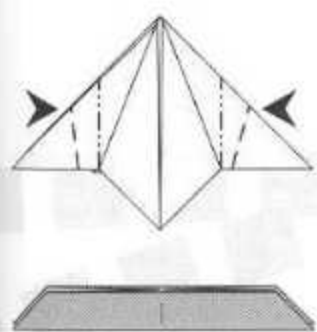

 Negro
 Blanco

 5 cm
 5 cm

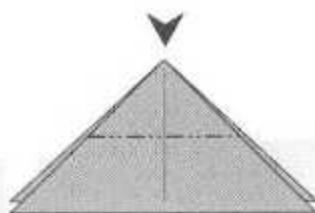
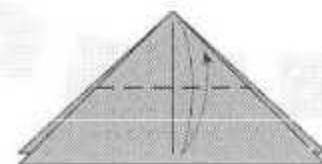
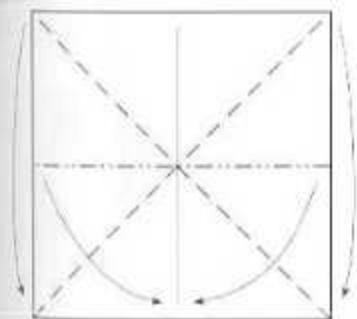
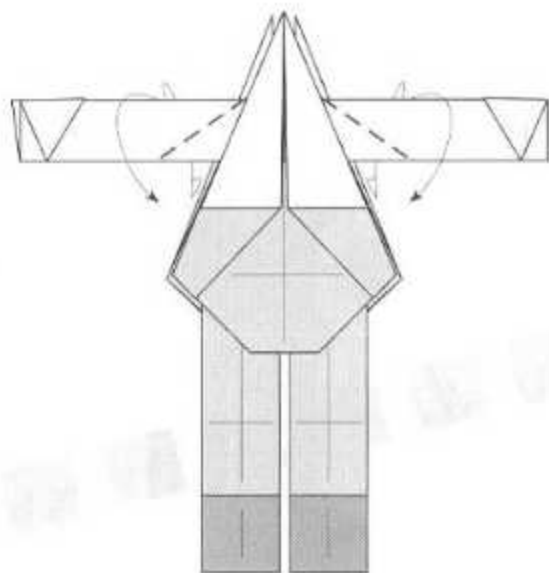
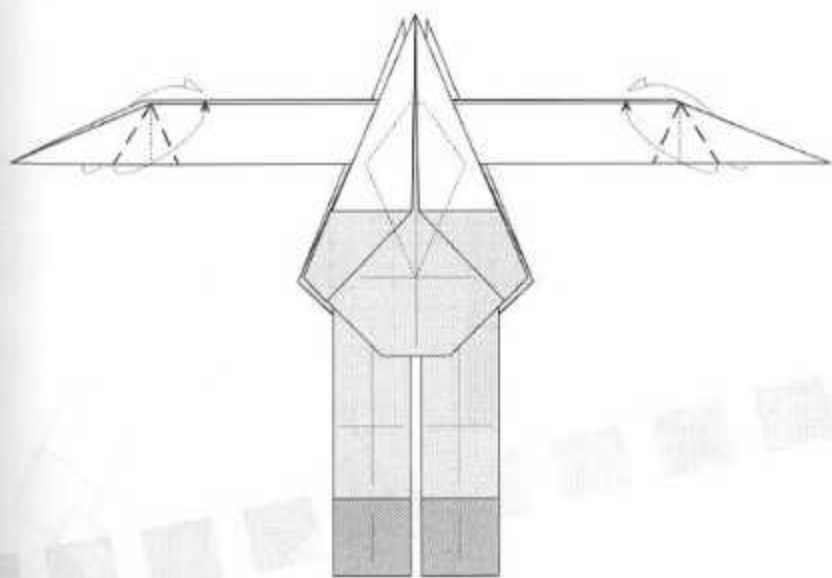

 Negro
 Negro

 5 cm
 5 cm



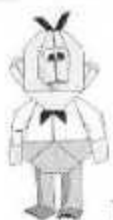
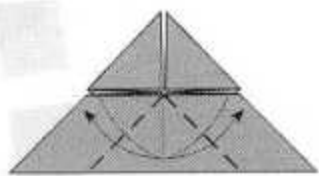
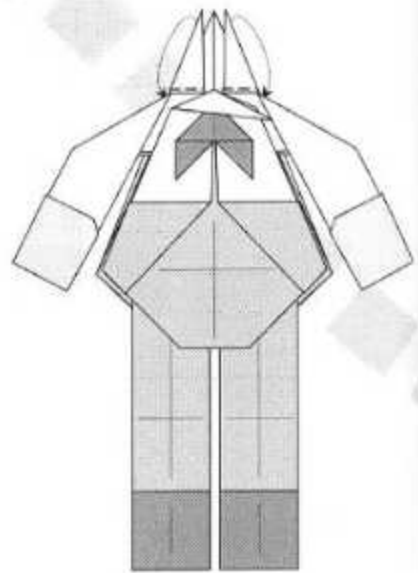
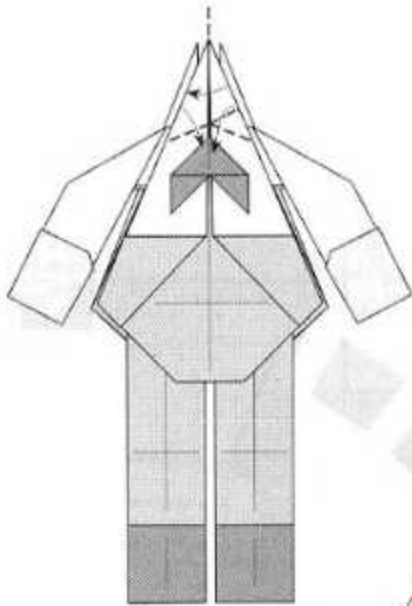
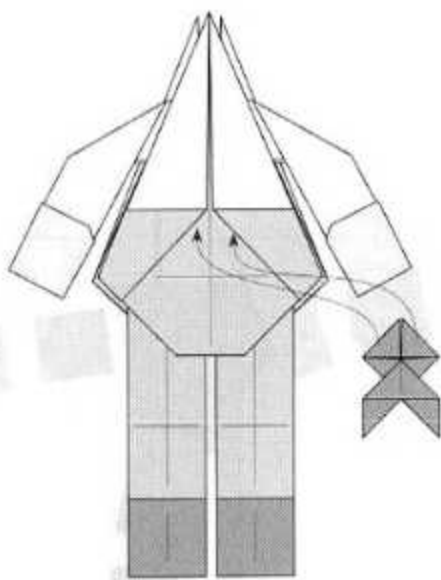
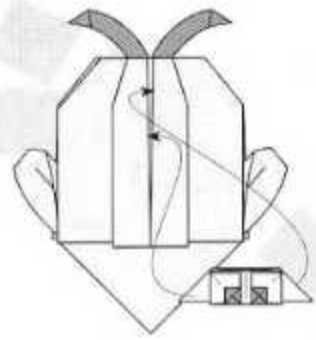
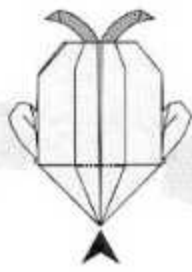
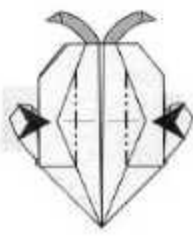

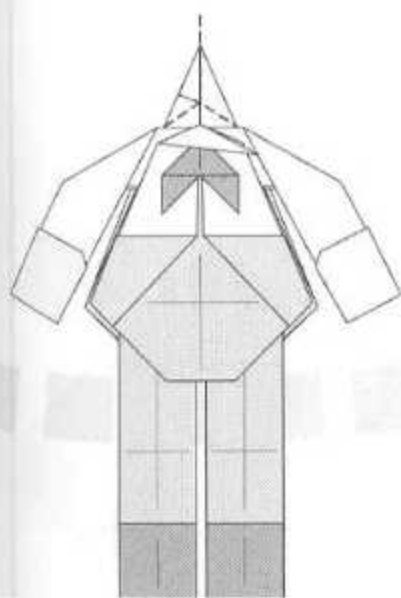
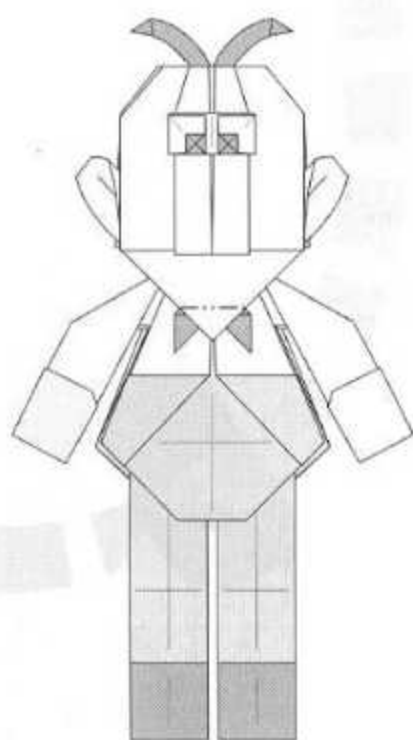
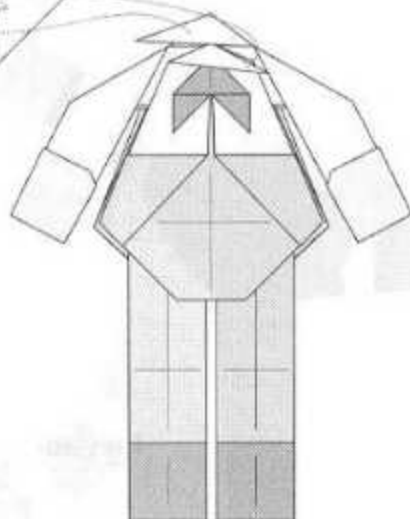
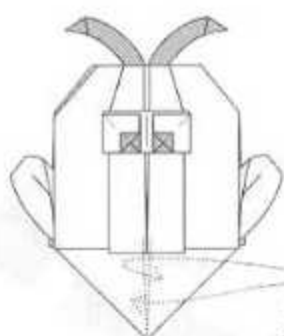
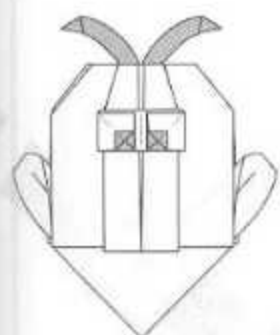
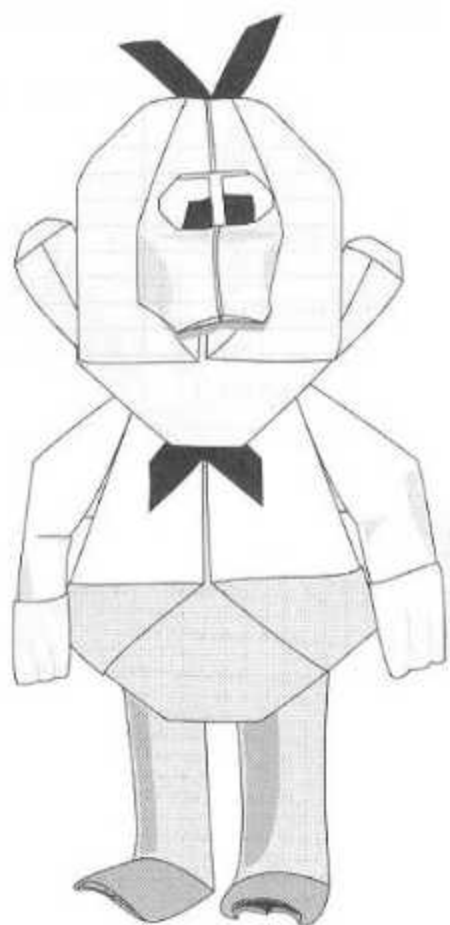

| Página (Desarr.) | Pieza nº | Cantidad | Porción | COLORES | | Tamaño original | Tamaño 3/10 | Tamaño 2/5 | Tamaño 3/5 |
|---------------------|----------|----------|-----------|---------|---------|-----------------|--------------|--------------|---------------|
| | | | | Anverso | Reverso | 20 cm alto | 6 cm alto | 8 cm alto | 12 cm alto |
| | | | | | | Lado (cm) = | Lado (cm) = | Lado (cm) = | Lado (cm) = |
| 105 | 1 | 1 | Cuerpo | Azul | Blanco | 20 | 6 | 8 | 12 |
| 106 | 2 | 2 | Piernas | Azul | Marrón | 15 | 4,5 | 6 | 9 |
| 106 | 3 | 1 | Chaqueta | Neutro | Azul | 20 | 6 | 8 | 12 |
| 106 | 4 | 1 | Brazos | Rosa | Azul | 20 | 6 | 8 | 12 |
| 108 | 5 | 1 | Corbata | Neutro | Negro | 5 | 1,5 | 2 | 3 |
| 110 | 6 | 1 | Base cara | Rosa | Rosa | 20 | 6 | 8 | 12 |
| 110 | 7 | 1 | Pelo | Neutro | Negro | 10 | 3 | 4 | 6 |
| 111 | 8 | 1 | Bigotes | Neutro | Negro | 10 | 3 | 4 | 6 |
| 111 | 9 | 1 | Ojos | Negro | Blanco | 5 | 1,5 | 2 | 3 |



Plegado por: Halle

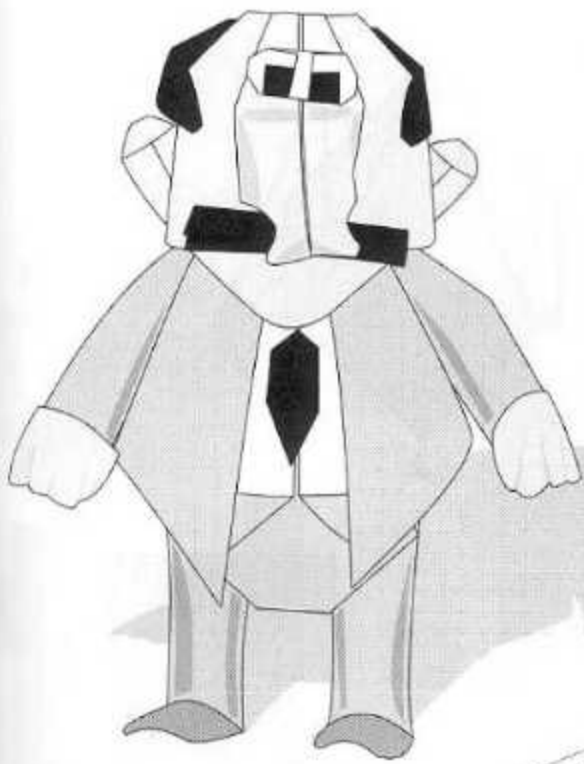

Utilizando las medidas recomendadas, se obtiene un modelo final de 20 cms.

| | |
|-----------------------------|------------|
| Autor: | Halle |
| Nivel de dificultad: | Medio-Alto |
| Número de piezas: | 10 |
| Forma de las piezas: | Cuadrados |

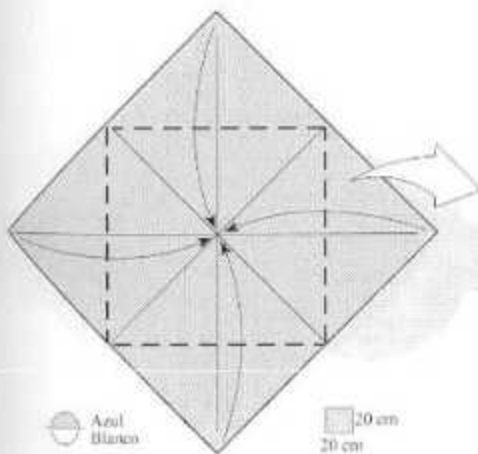
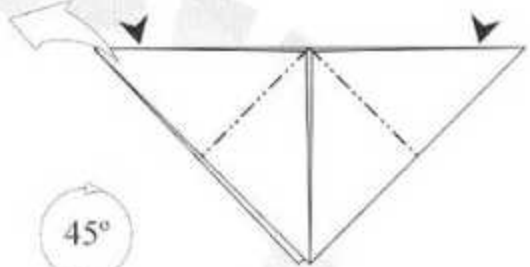
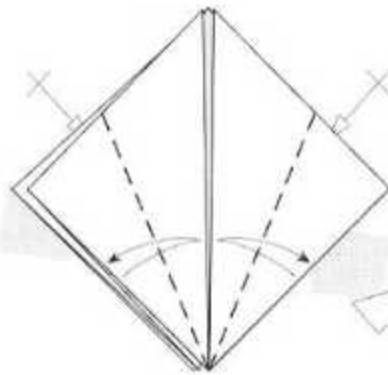
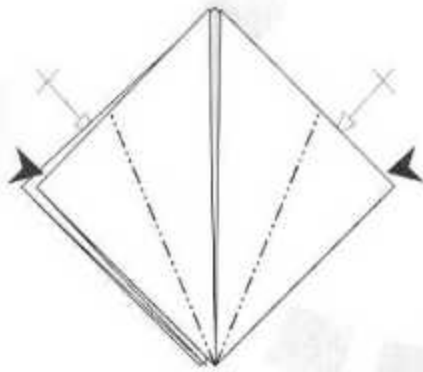
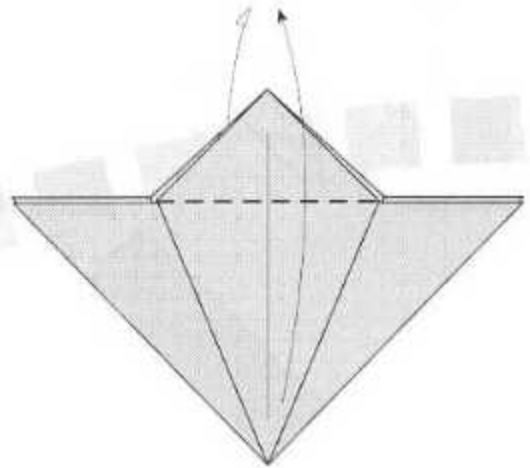
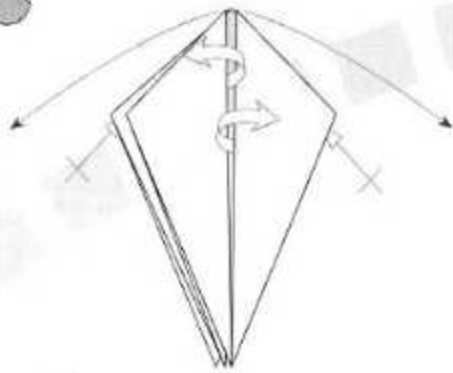

45°

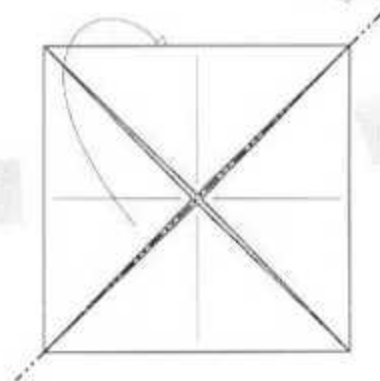

● Azul
○ Blanco

■ 20 cm
□ 20 cm



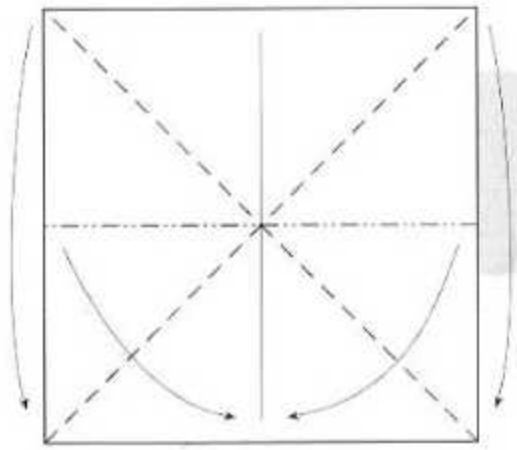
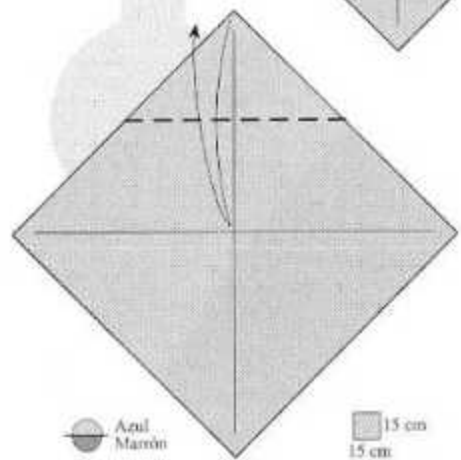
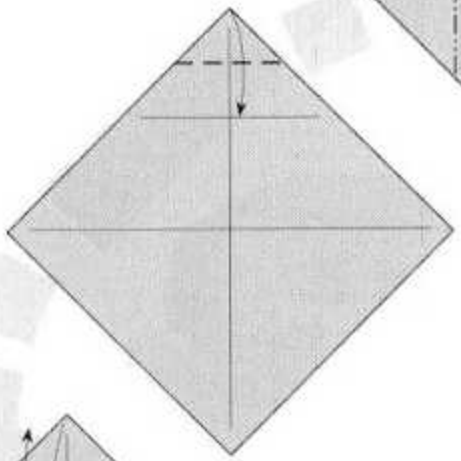
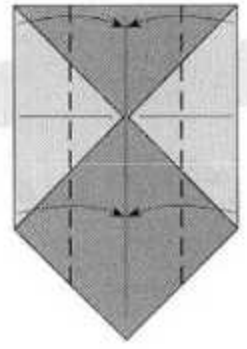
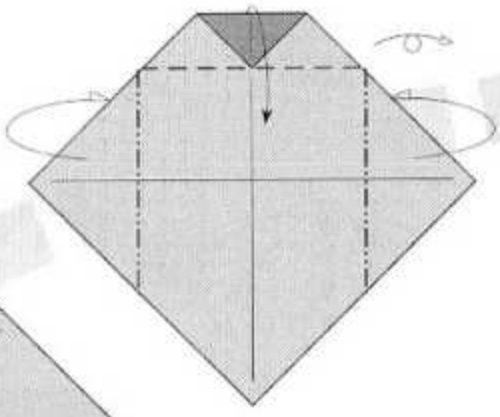
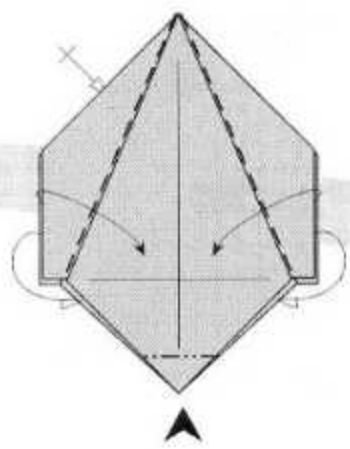
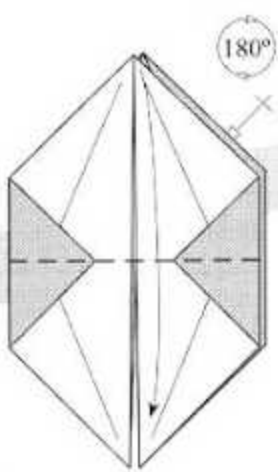
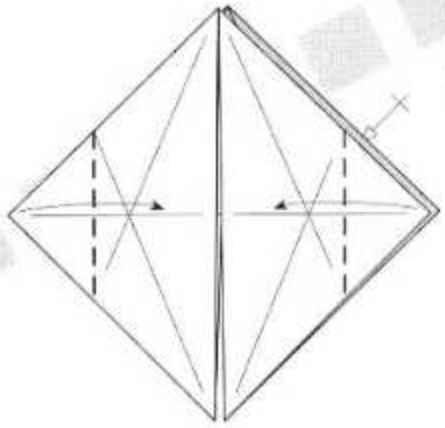

● Azul
● Marrón

■ 15 cm
■ 15 cm

● Azul

□ 20 cm
□ 20 cm

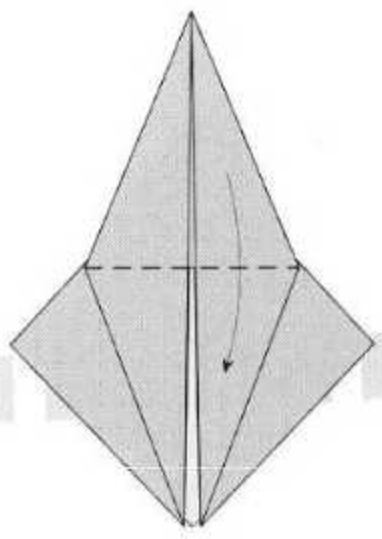
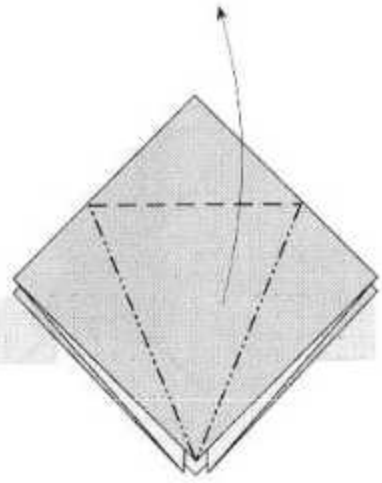
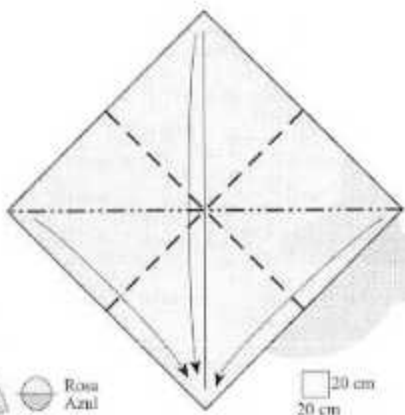

● Rosa
● Azul

□ 20 cm
□ 20 cm



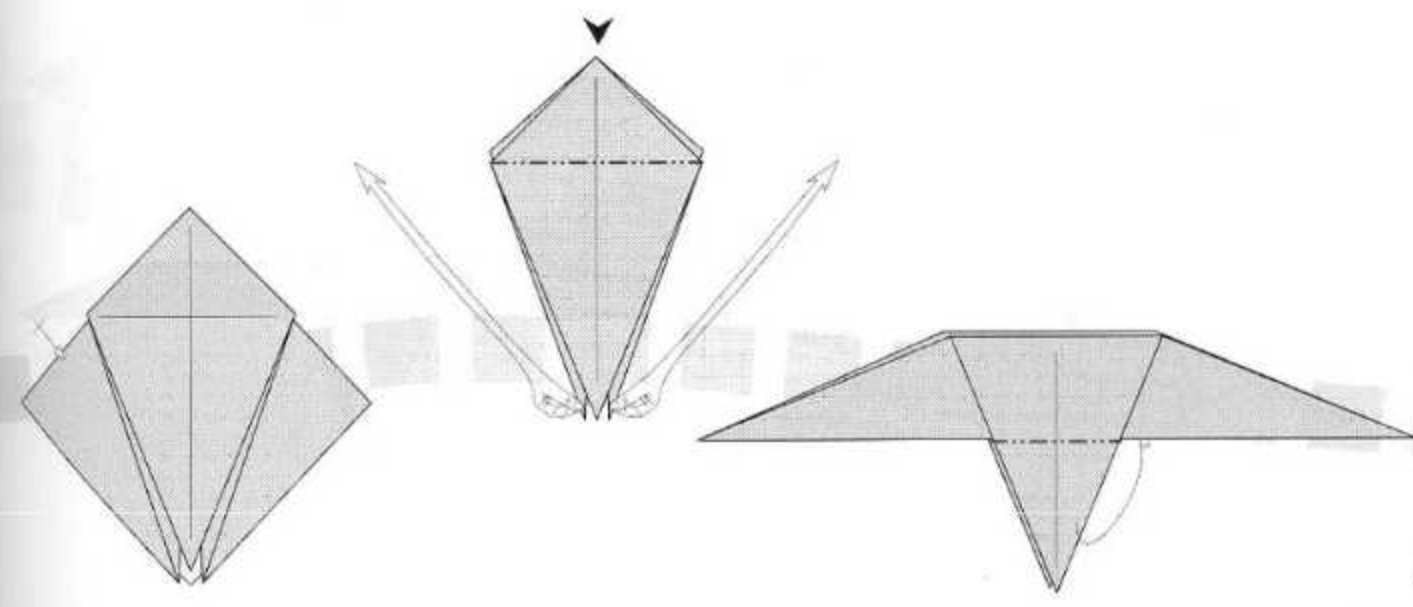
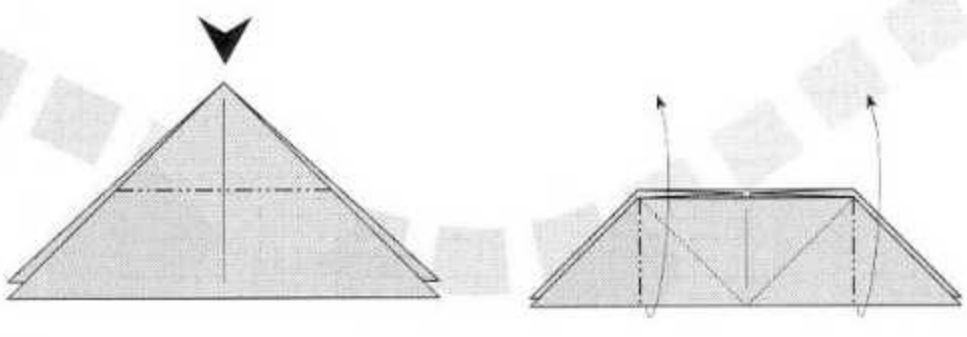
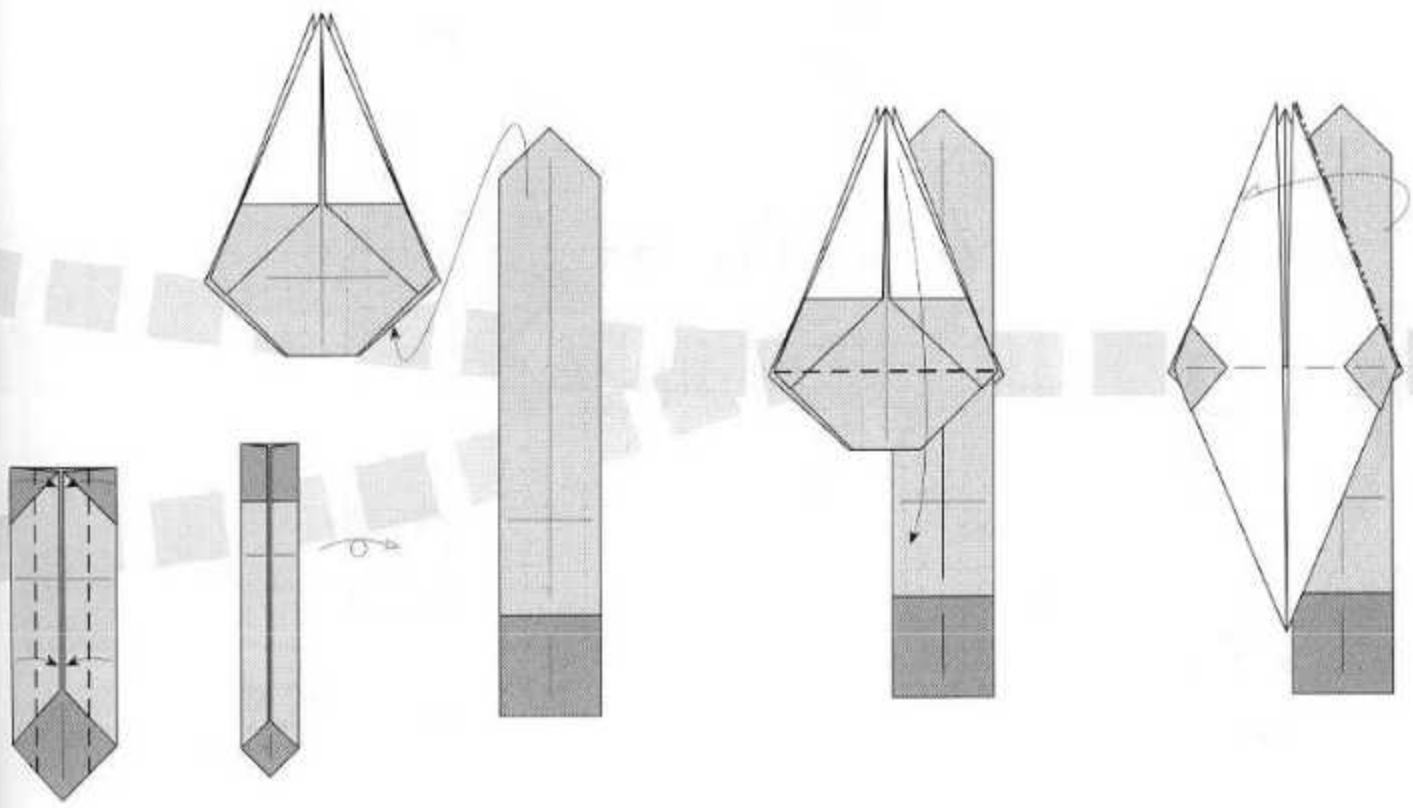

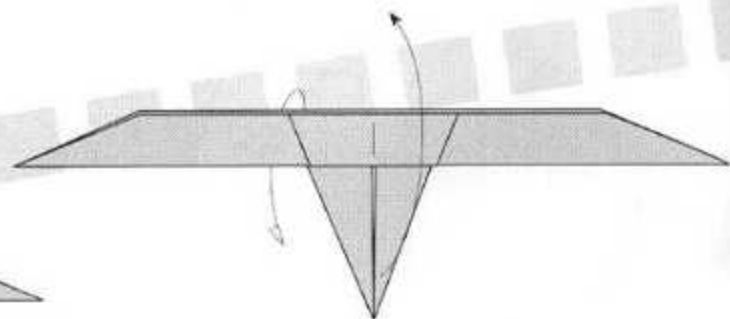
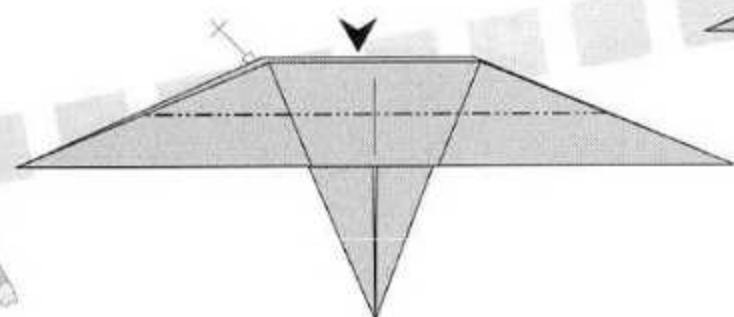
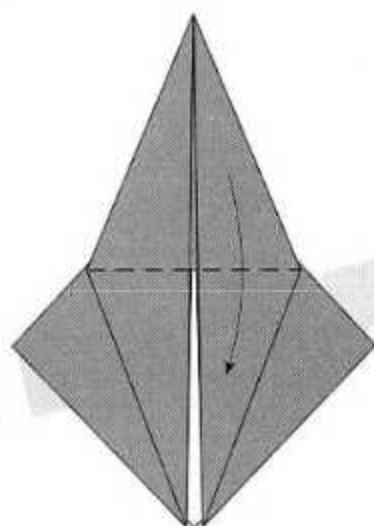
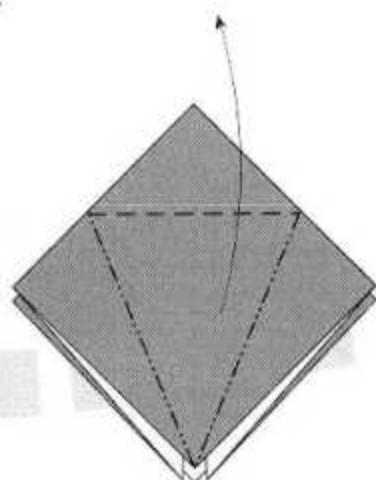
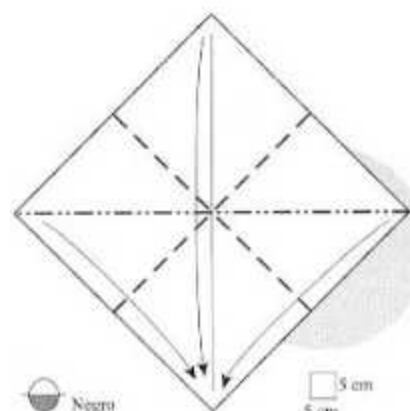
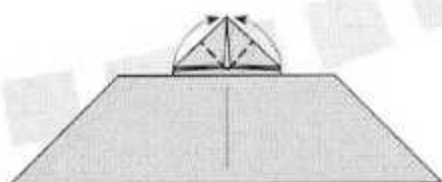
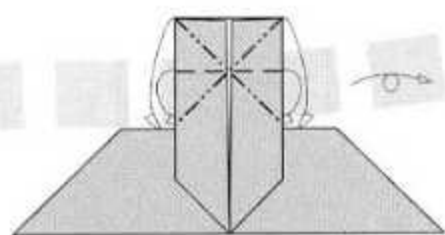
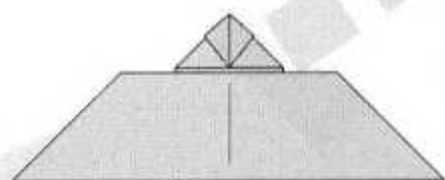
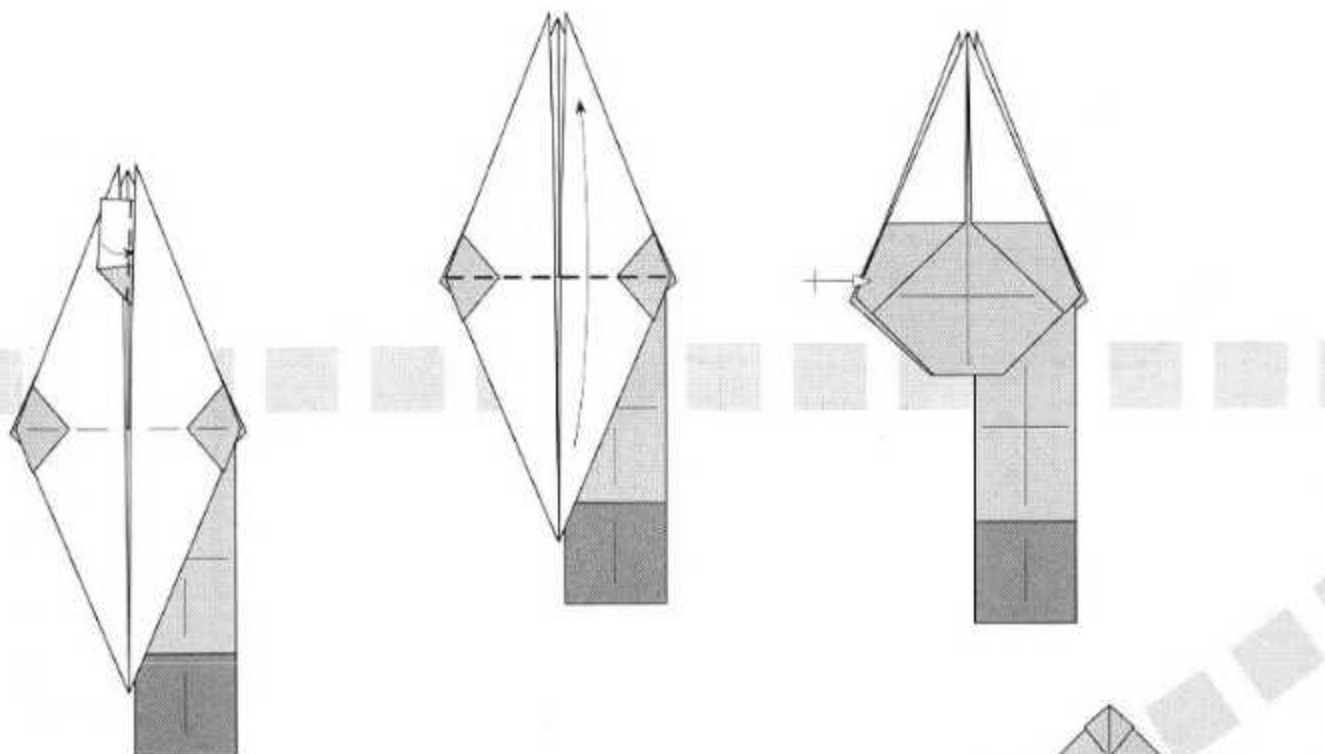

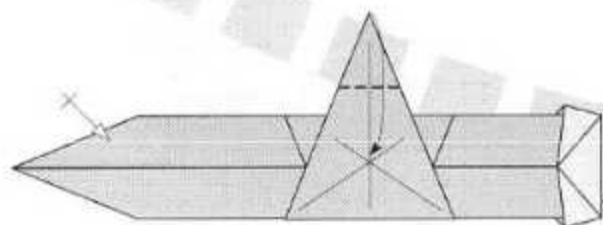
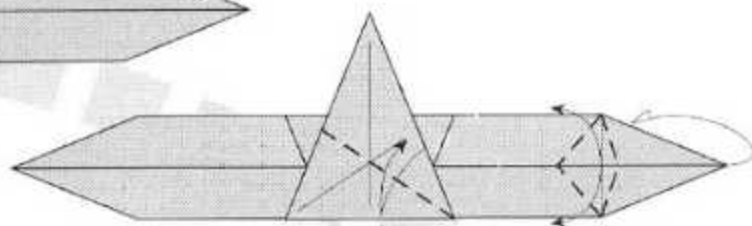
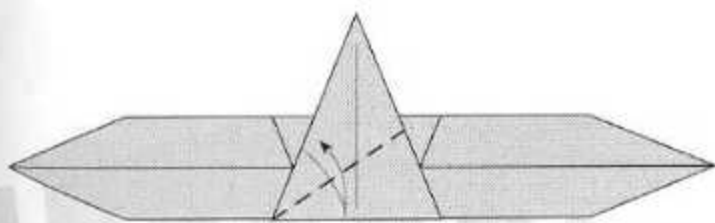
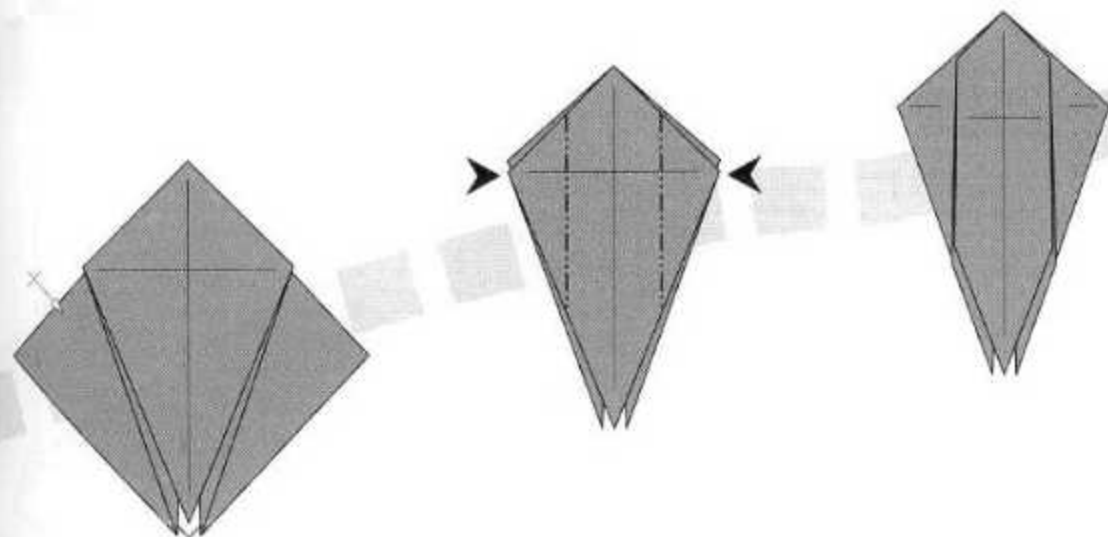
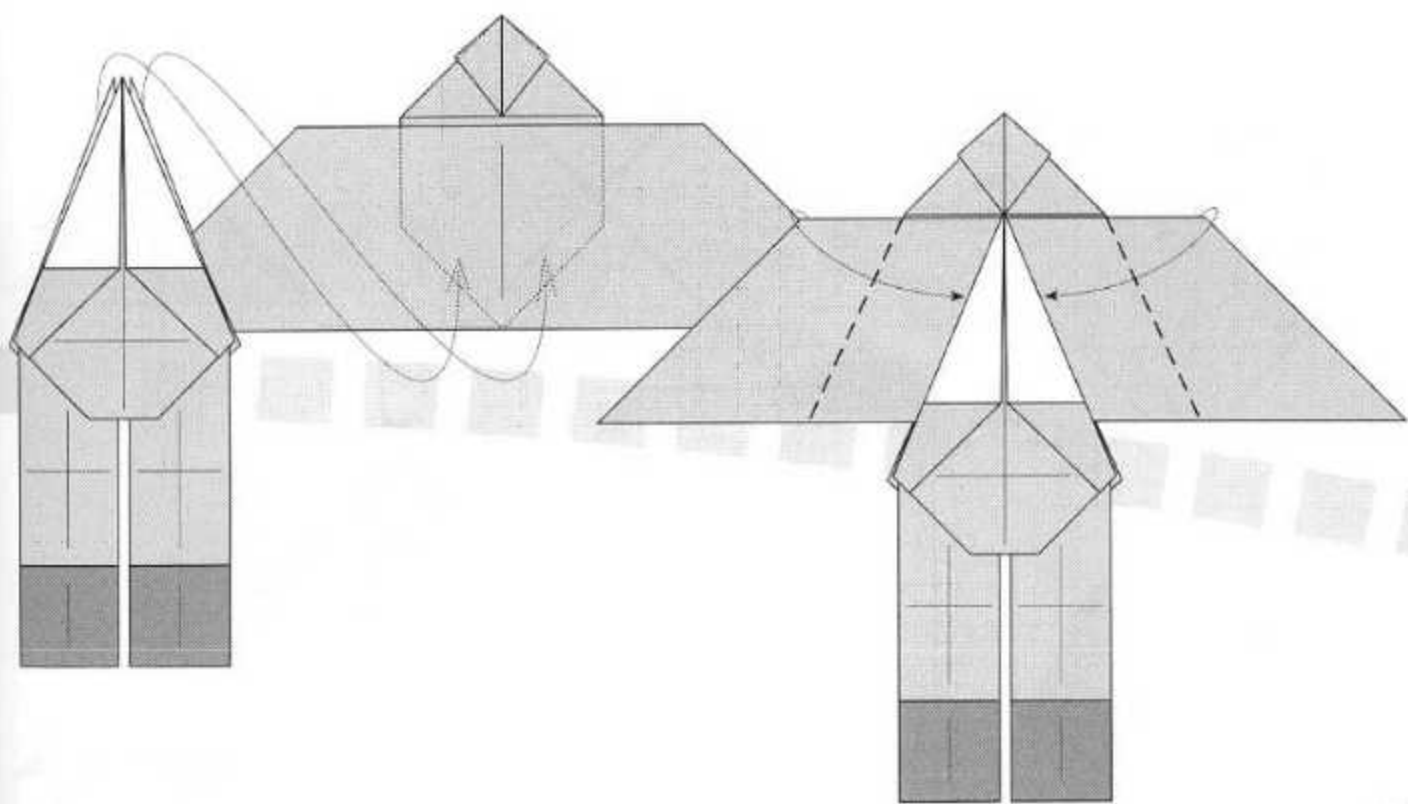

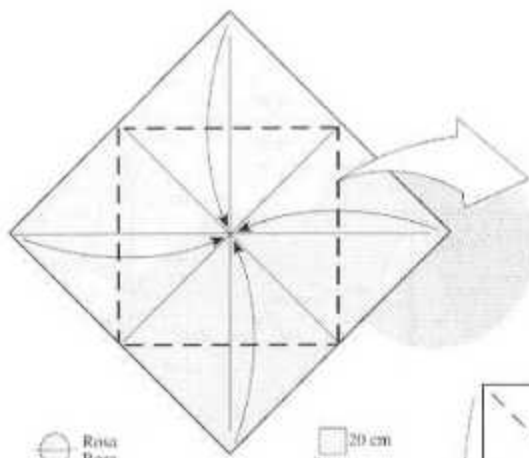

Rosa
Rosa

20 cm
20 cm

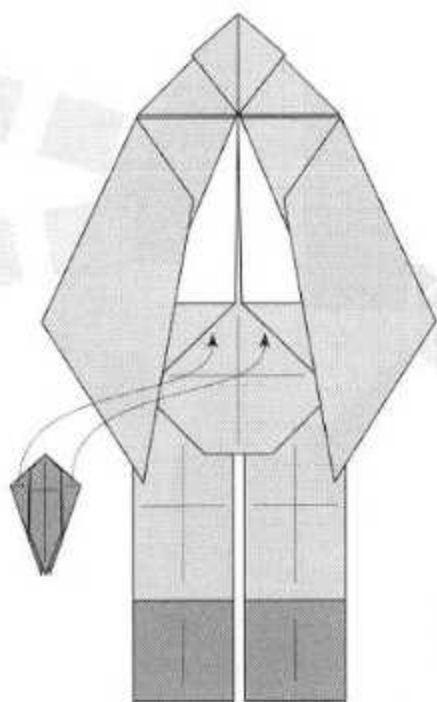
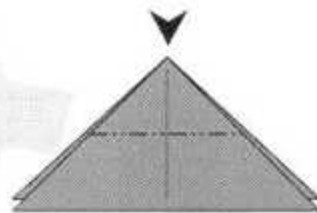
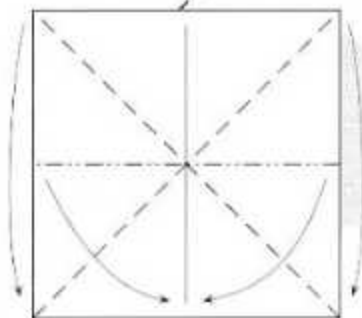
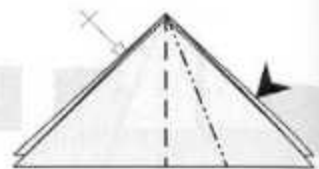
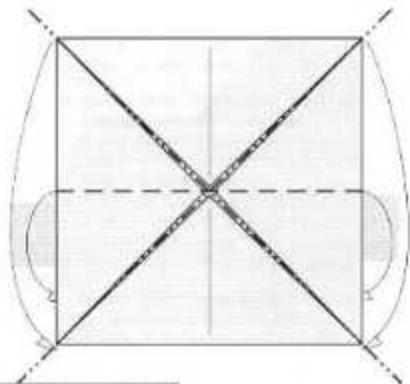

Negro

10 cm
10 cm

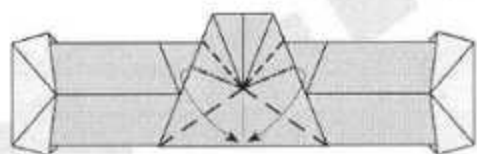
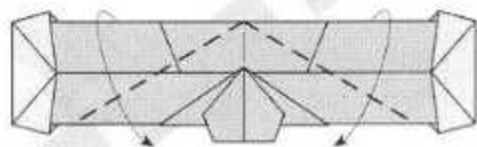
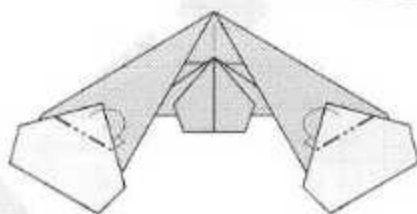
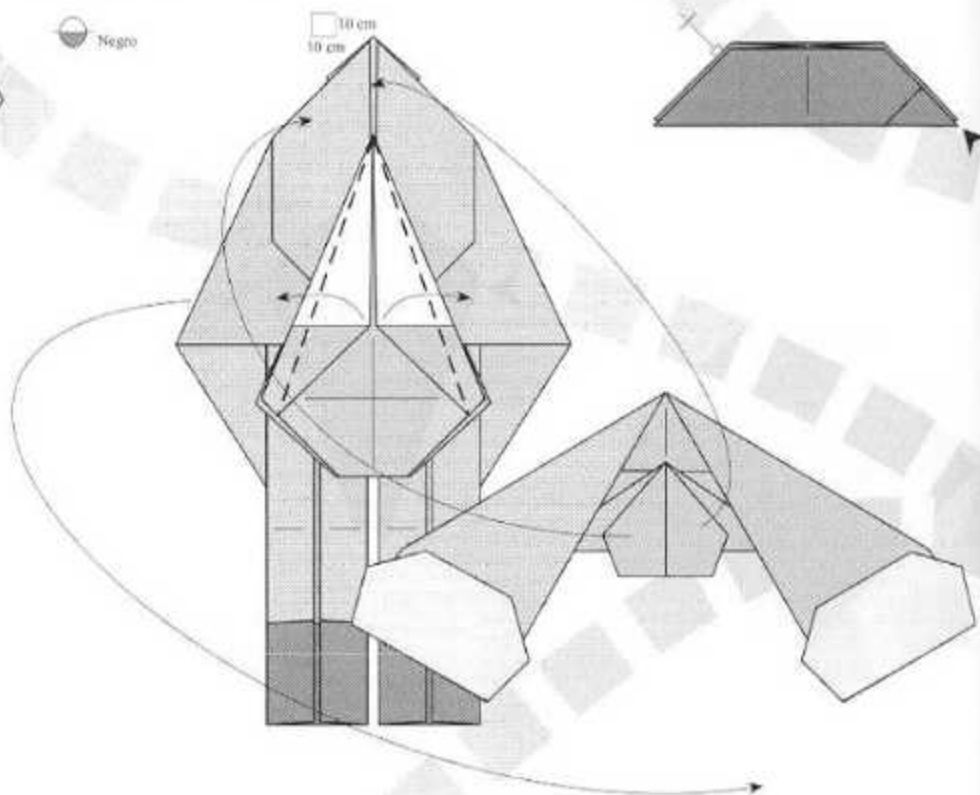

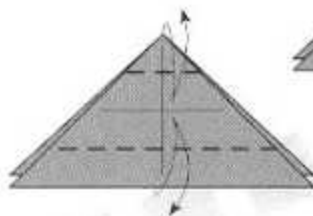
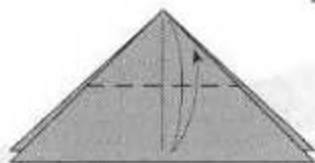
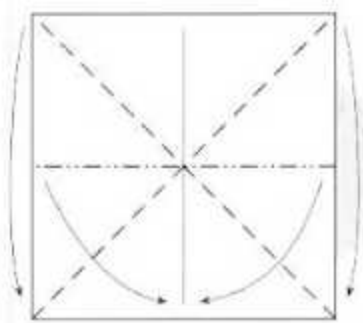
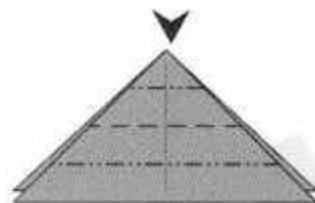
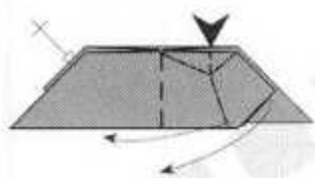
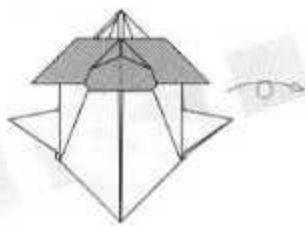
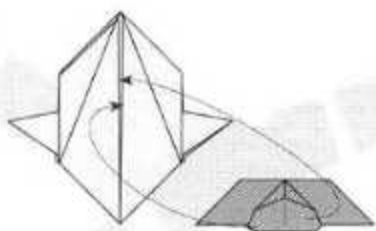
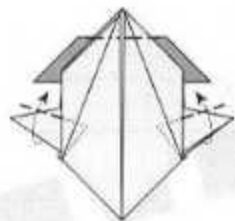
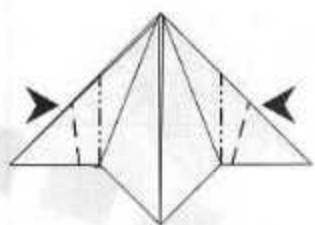

● Negro

□ 10 cm
10 cm

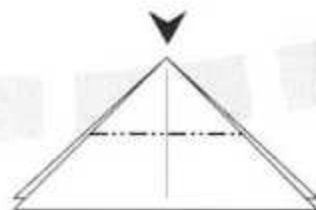
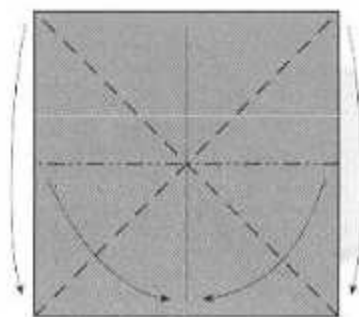

● Negro
○ Blanco

■ 10 cm
10 cm

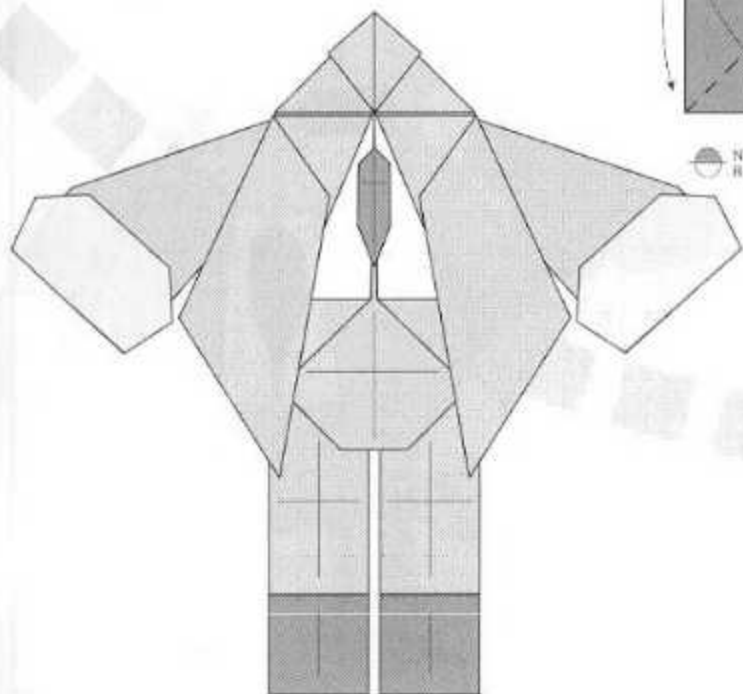

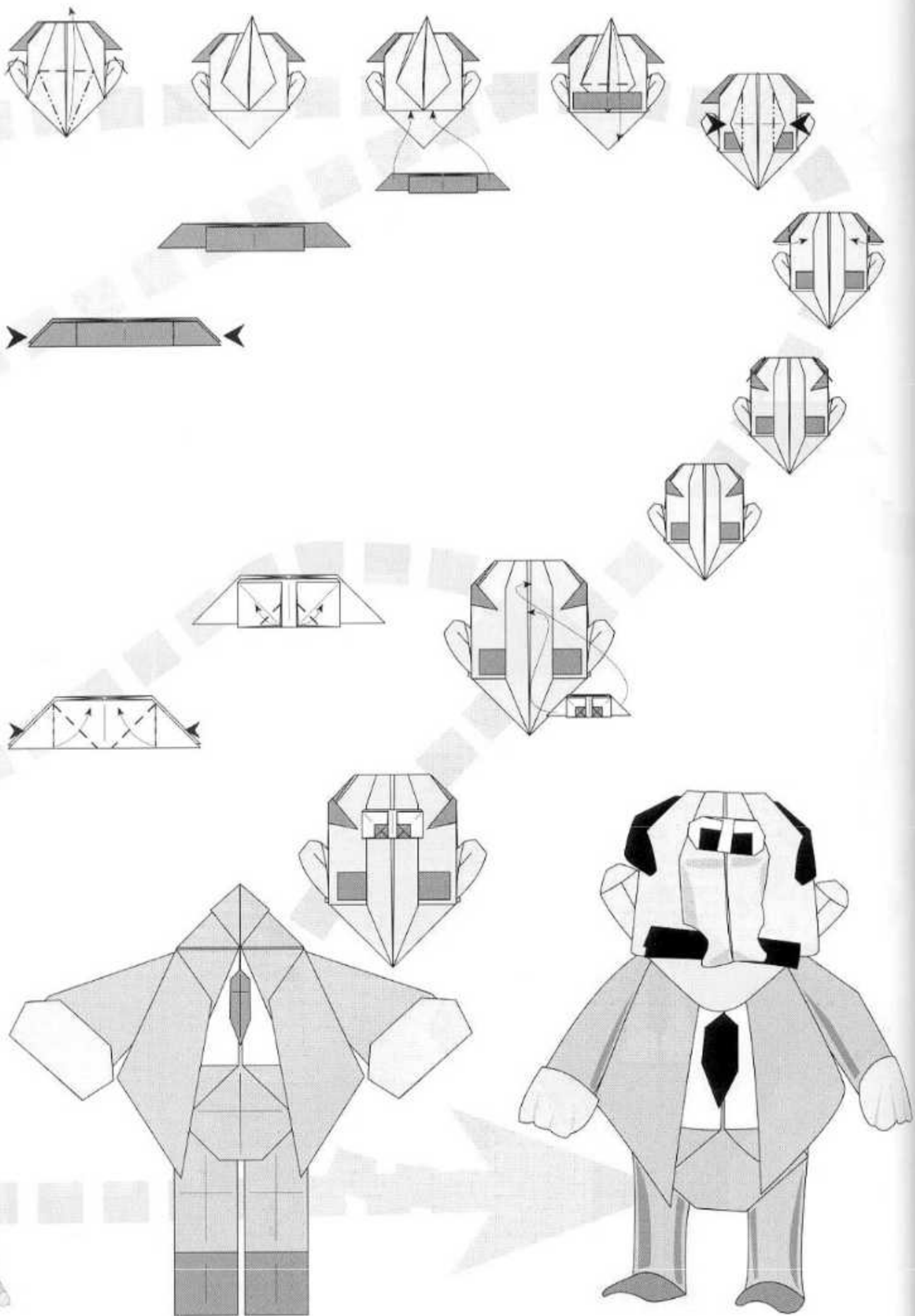

| Página (Desarr.) | Pieza n° | Cantidad | Porción | COLORES | | Tamaño original | Tamaño 3/10 | Tamaño 2/5 | Tamaño 3/5 |
|---------------------|----------|----------|----------|---------|---------|-----------------|--------------|--------------|--------------|
| | | | | Anverso | Reverso | 10 cm alto | 3 cm alto | 4 cm alto | 6 cm alto |
| | | | | | | Lado (cm) = | Lado (cm) = | Lado (cm) = | Lado (cm) = |
| 115 | 1 | 1 | Capucha | Neutro | Naranja | 15 | 4,5 | 6 | 9 |
| 114 | 2 | 1 | Ferrocil | Neutro | Marrón | 10 | 3 | 4 | 6 |
| 114 | 3 | 1 | Cara | Neutro | Rosa | 7,5 | 2,25 | 3 | 4,5 |
| 114 | 4 | 1 | Ojos | Negro | Bianco | 5 | 1,5 | 2 | 3 |
| 115 | 5 | 1 | Cuerpo | Naranja | Marrón | 15 | 4,5 | 6 | 9 |
| 116 | 6 | 1 | Pies | Naranja | Negro | 10 | 3 | 4 | 6 |



Plegado por: Nicolas Terry

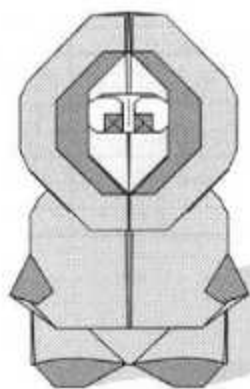

Utilizando las medidas recomendadas, se obtiene un modelo final de 10 cms.

| | |
|-----------------------------|-----------|
| Autor: | Halle |
| Nivel de dificultad: | Bajo |
| Número de piezas: | 6 |
| Forma de las piezas: | Cuadrados |

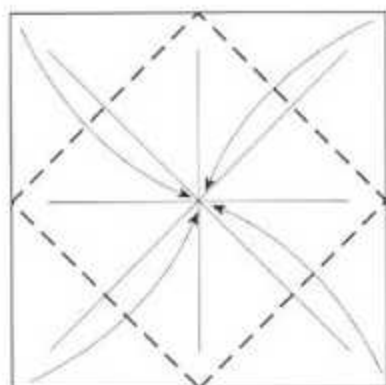

Marrón

10 cm
10 cm

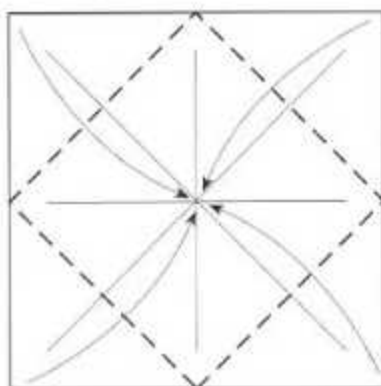
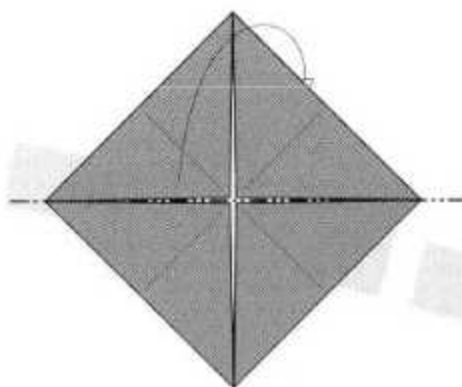

Rosa

7,5 cm
7,5 cm

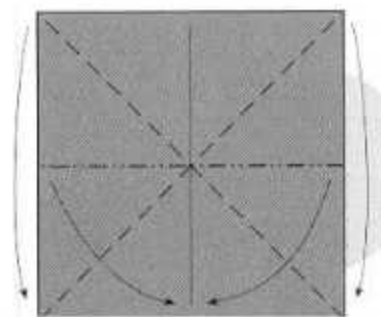
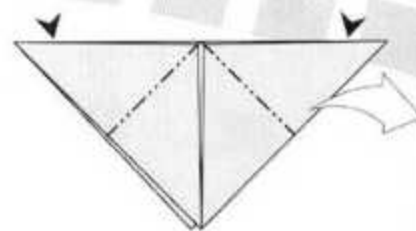
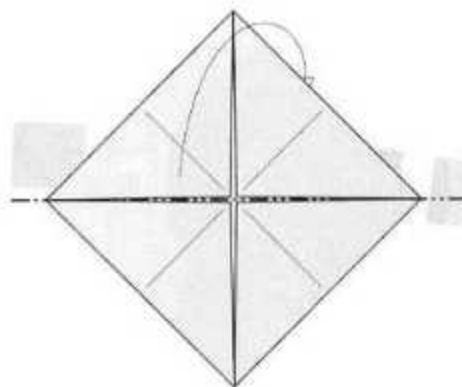

Negro
Blanco

5 cm
5 cm

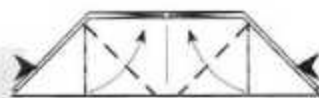
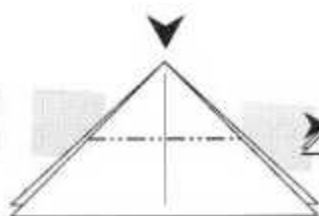

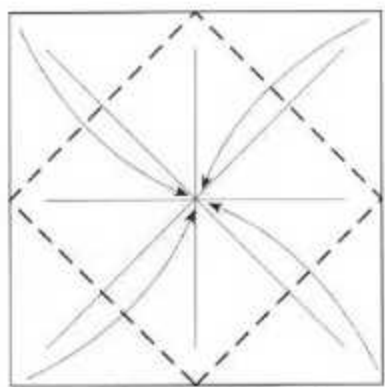

● Naranja
15 cm
15 cm

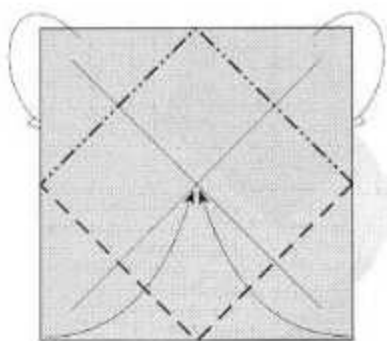

● Naranja
Marron
15 cm
15 cm

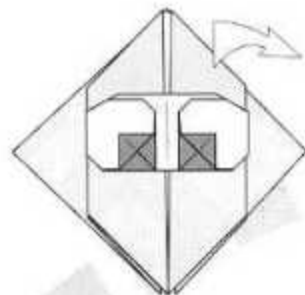
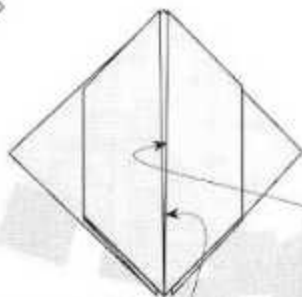
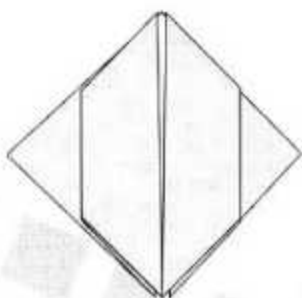
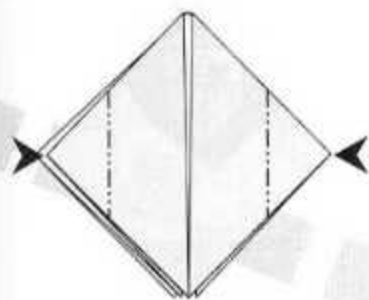
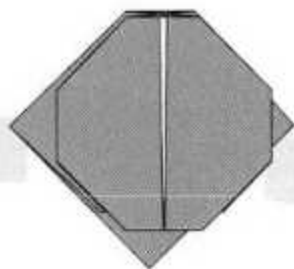
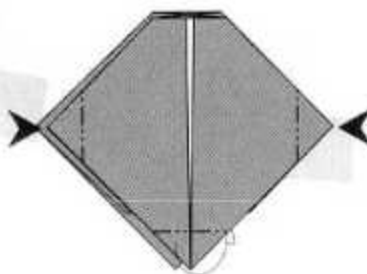
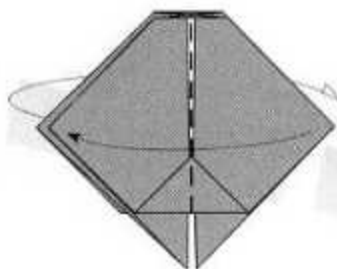
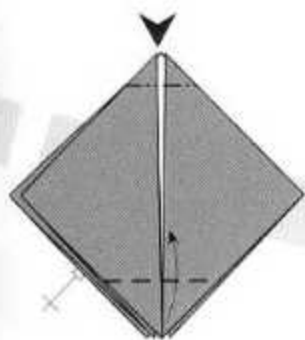
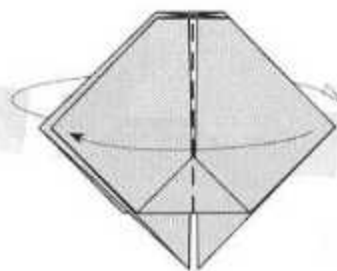
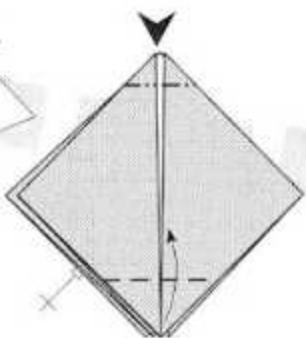
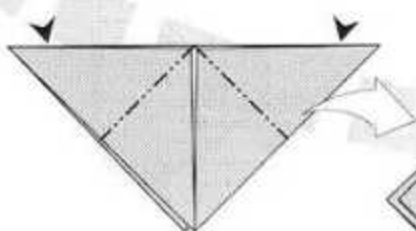
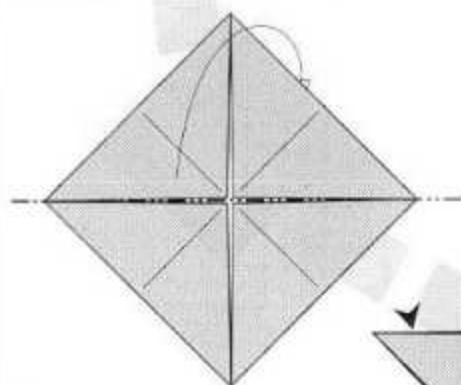
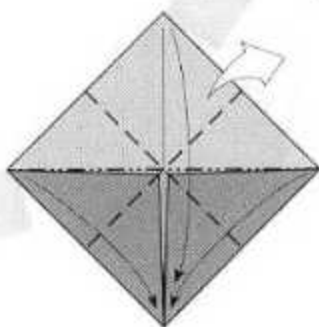
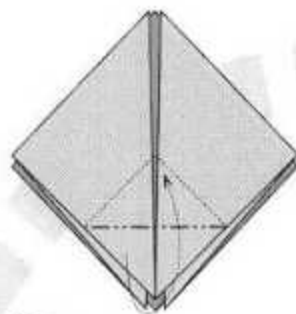

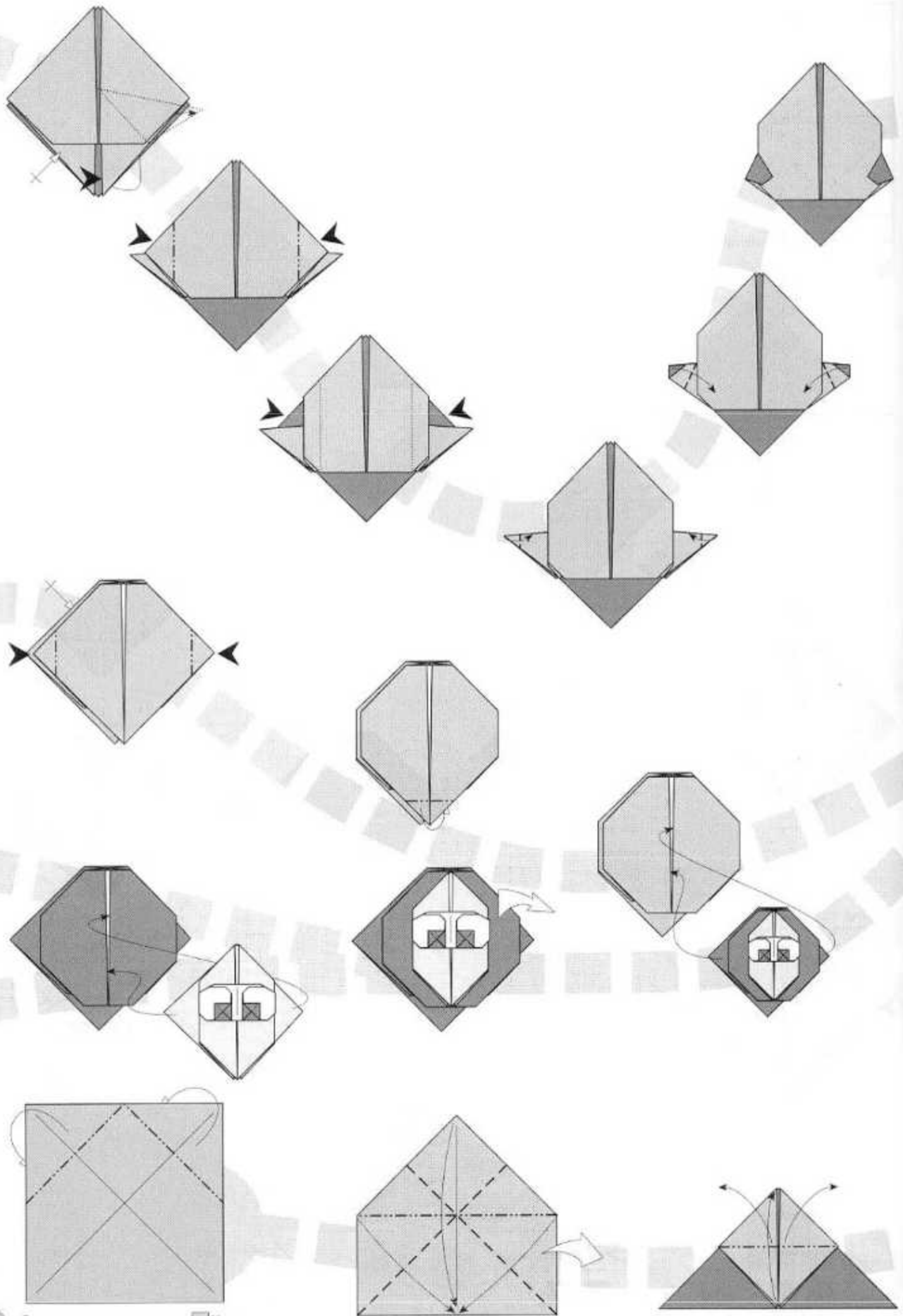

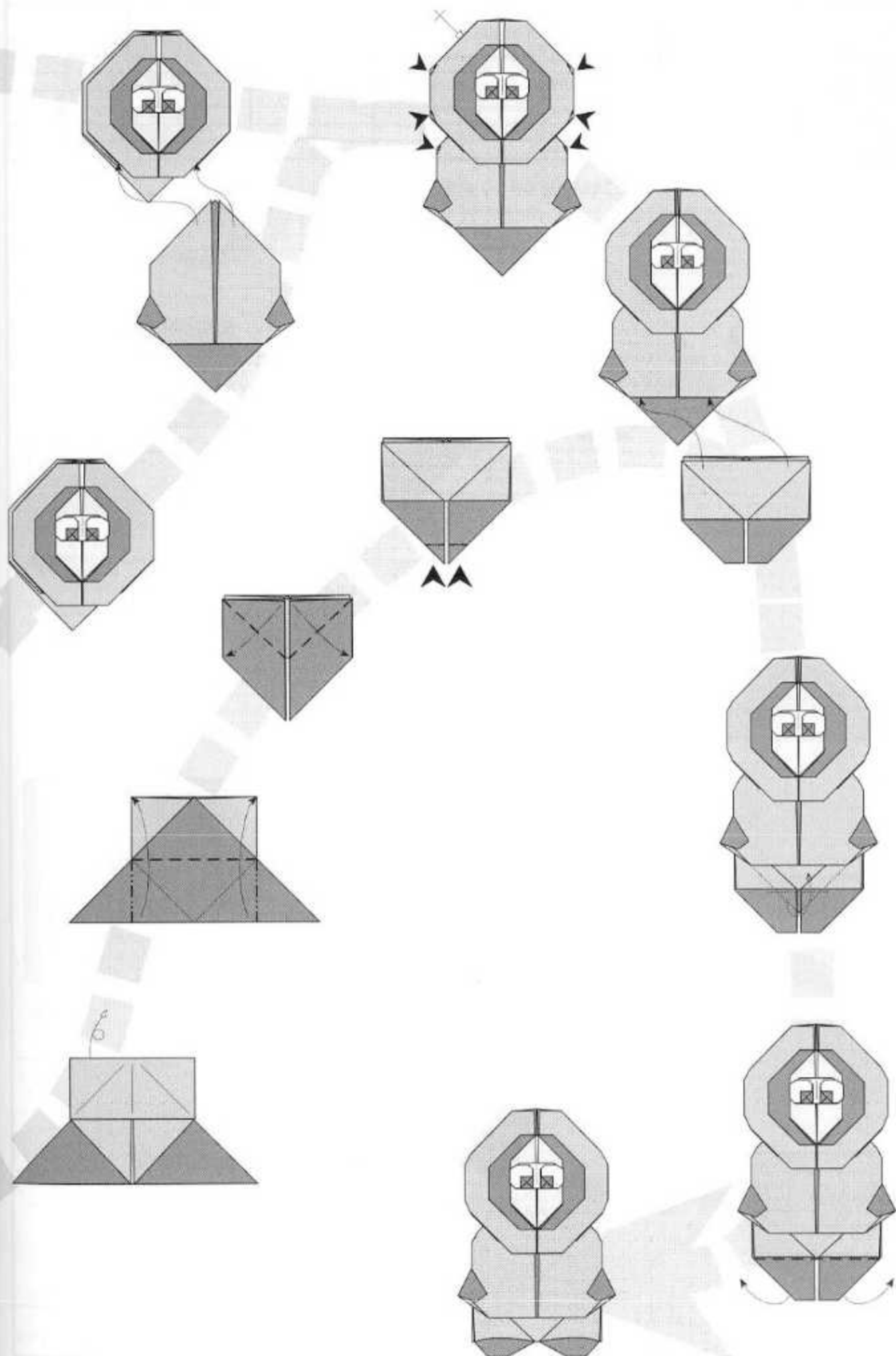

| Página (Desarr.) | Pieza nº | Cantidad | Porción | COLORES | | Tamaño original | Tamaño 3/10 | Tamaño 2/5 | Tamaño 3/5 |
|---------------------|----------|----------|---------|---------|---------|-----------------|--------------|--------------|--------------|
| | | | | Anverso | Reverso | 10 cm alto | 3 cm alto | 4 cm alto | 6 cm alto |
| | | | | | | Lado (cm) = | Lado (cm) = | Lado (cm) = | Lado (cm) = |
| 119 | 1 | 1 | Cuerpo | Marrón | Rojo | 15 | 4,5 | 6 | 9 |
| 119 | 2 | 1 | Pies | Azul | Negro | 10 | 3 | 4 | 6 |
| 119 | 3 | 1 | Cara | Neutro | Rosa | 15 | 4,5 | 6 | 9 |
| 119 | 4 | 1 | Ojos | Negro | Bianco | 5 | 1,5 | 2 | 3 |
| 120 | 5 | 1 | Nariz | Neutro | Negro | 2,5 | 0,75 | 1 | 1,5 |
| 120 | 6 | 1 | Gorro | Rojo | Azul | 7 | 2,1 | 2,8 | 4,2 |
| 121 | 7 | 1 | Borla | Neutro | Rojo | 4 | 1,2 | 1,6 | 2,4 |
| 122 | 8 | 2 | Cejas | Neutro | Negro | 1,7 | 0,51 | 0,68 | 1,02 |



Plegado por: Nicolas Terry

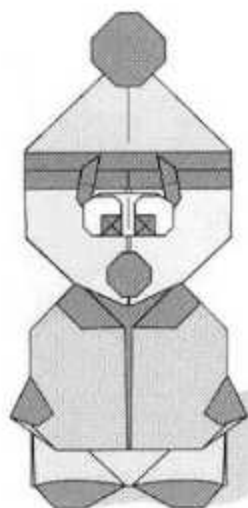

Utilizando las medidas recomendadas, se obtiene un modelo final de 10 cms.

| | |
|-----------------------------|-----------|
| Autor: | Halle |
| Nivel de dificultad: | Bajo |
| Número de piezas: | 9 |
| Forma de las piezas: | Cuadrados |

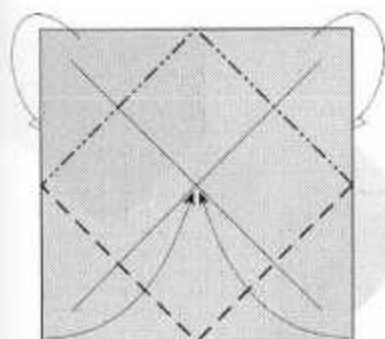

Marrón
Rojo

15 cm
15 cm

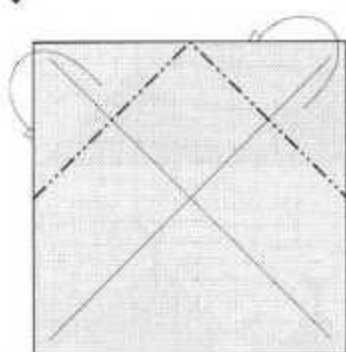
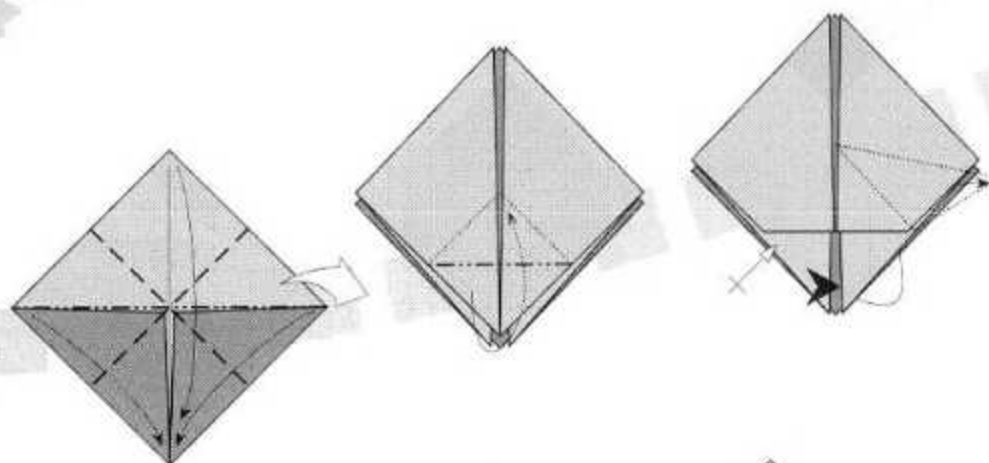

Azul
Negro

10 cm
10 cm

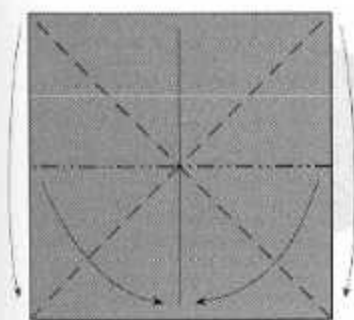
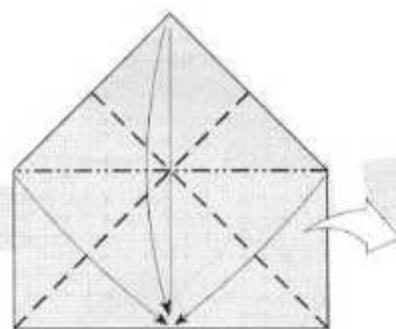

Negro
Blanco

5 cm
5 cm

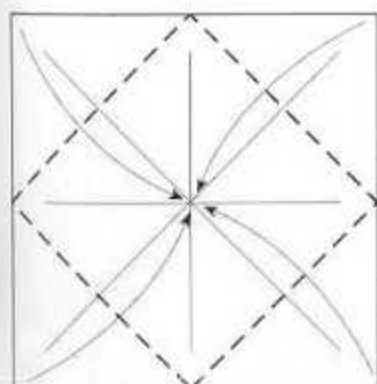
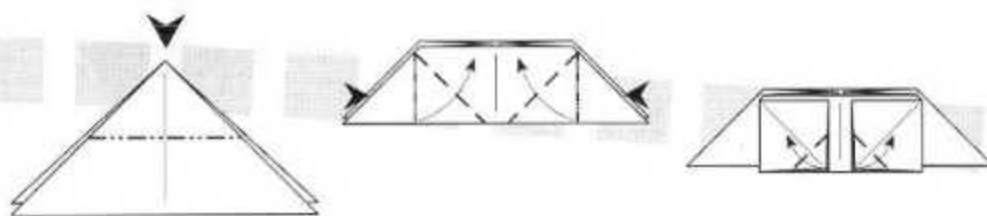

Rosa

15 cm
15 cm

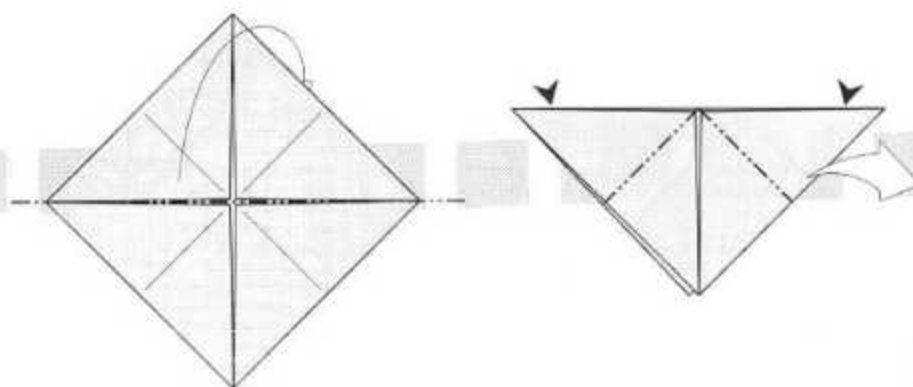

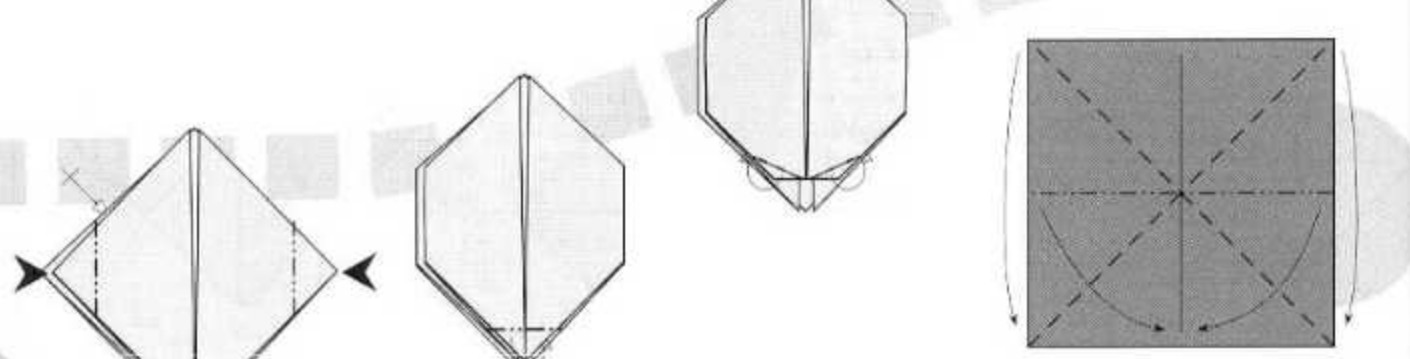
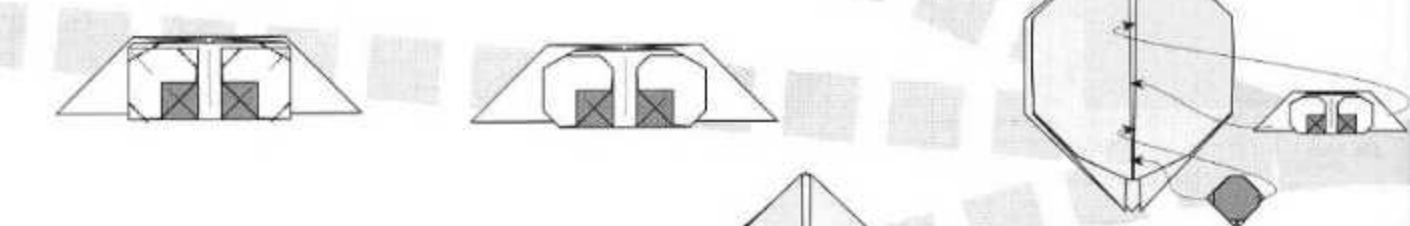
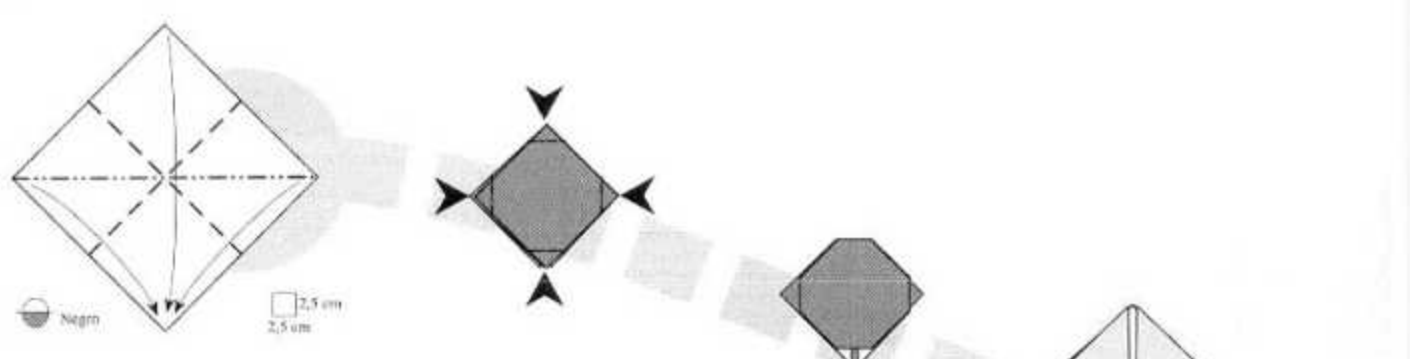
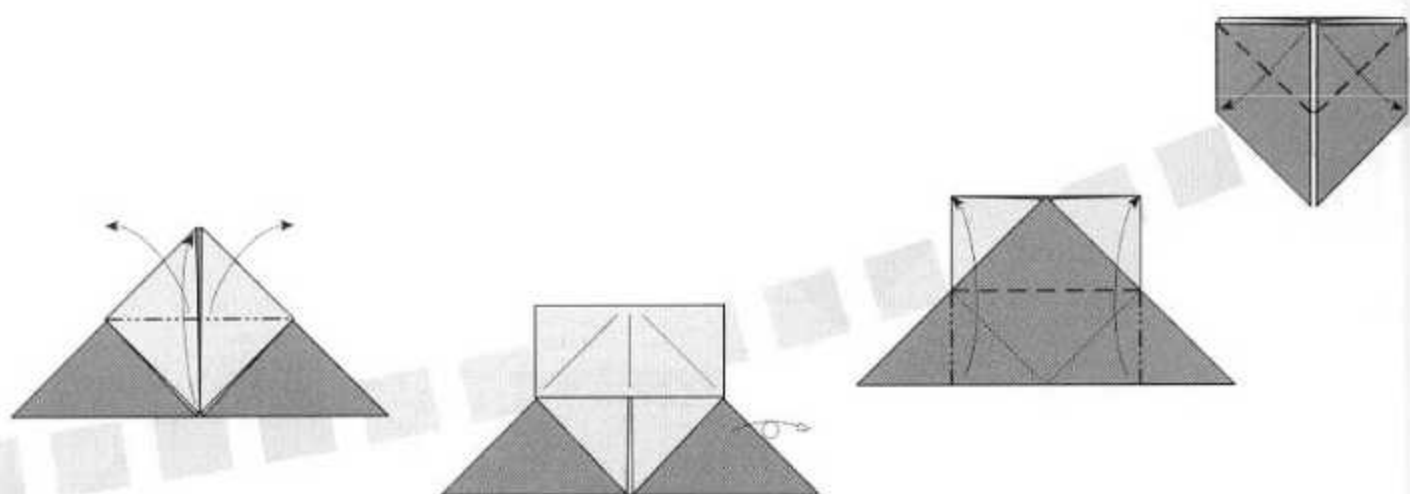
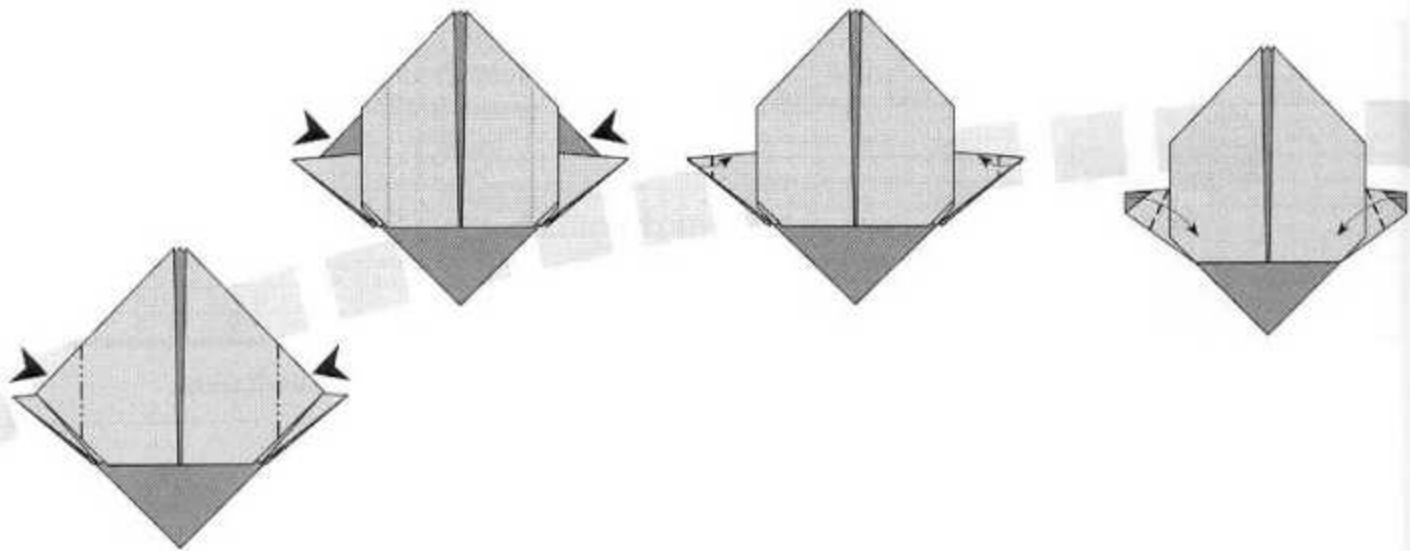

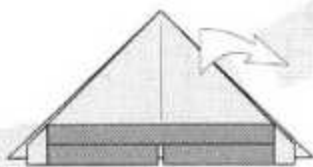
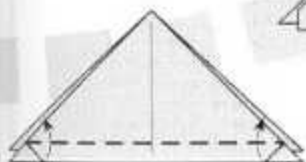
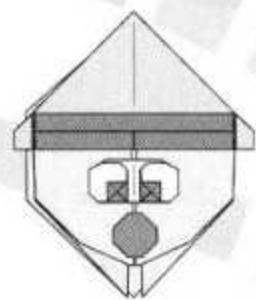
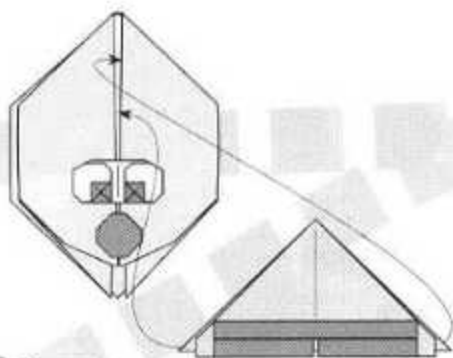
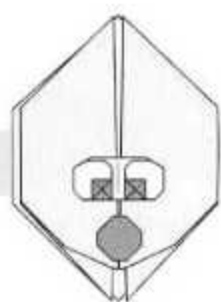
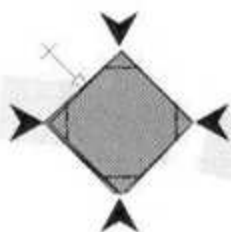
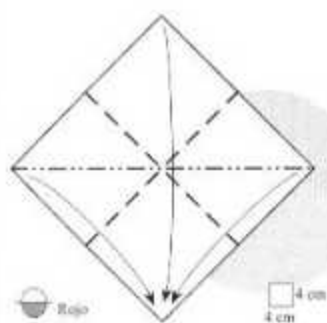
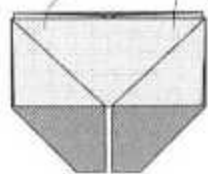
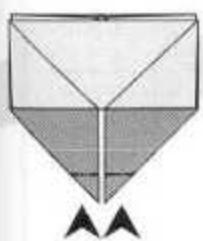
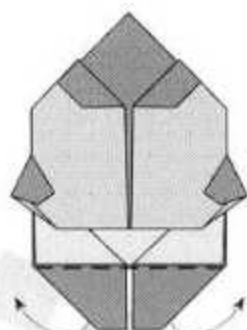
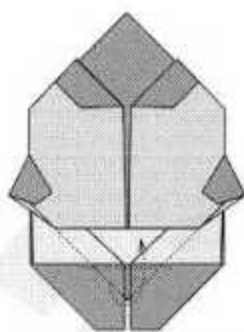
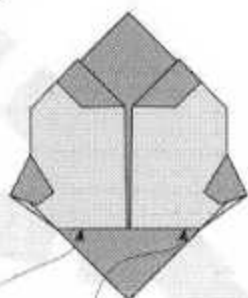
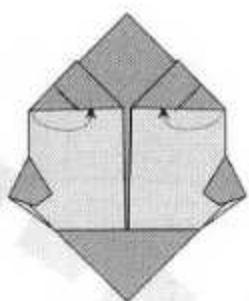
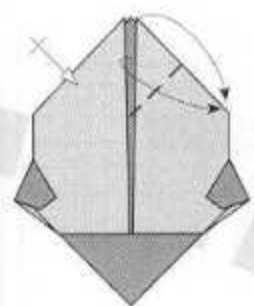

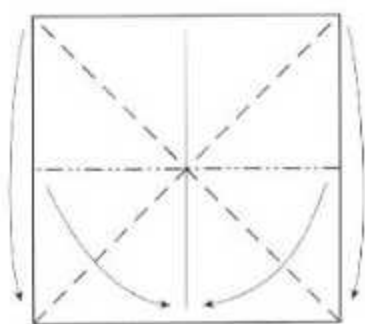

Signo

1,7 cm
1,7 cm

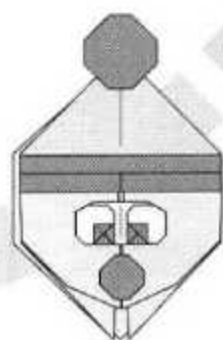
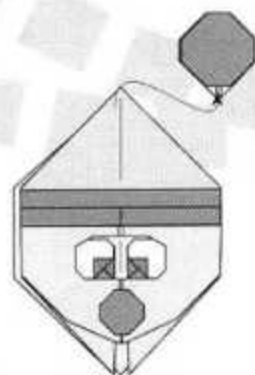
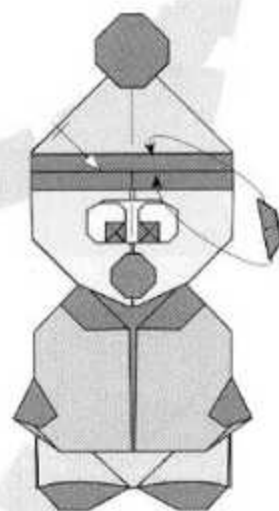
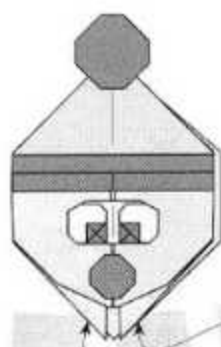
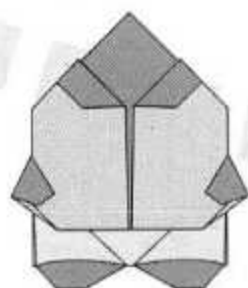
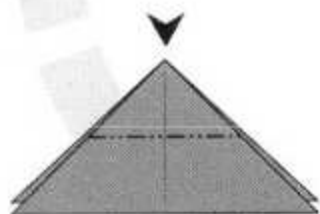

| Página (Desarr.) | Pieza nº | Cantidad | Porción | COLORES | | Tamaño original | Tamaño 3/10 | Tamaño 2/5 | Tamaño 3/5 |
|---------------------|----------|----------|---------|---------|---------|-----------------|-------------|-------------|-------------|
| | | | | Anverso | Reverso | 10 cm alto | 3 cm alto | 4 cm alto | 6 cm alto |
| | | | | | | Lado (cm) = | Lado (cm) = | Lado (cm) = | Lado (cm) = |
| 124 | 1 | 1 | Cuerpo | Naranja | Verde | 15 | 4,5 | 6 | 9 |
| 124 | 2 | 1 | Pies | Verde | Negro | 10 | 3 | 4 | 6 |
| 124 | 3 | 1 | Cara | Neutro | Rosa | 15 | 4,5 | 6 | 9 |
| 125 | 4 | 1 | Ojos | Negro | Bianco | 5 | 1,5 | 2 | 3 |
| 126 | 5 | 1 | Boca | Bianco | Negro | 1,7 | 0,51 | 0,68 | 1,02 |
| 126 | 6 | 1 | Gorra | Bianco | Verde | 15 | 4,5 | 6 | 9 |



Plegado por: Nicolas Terry

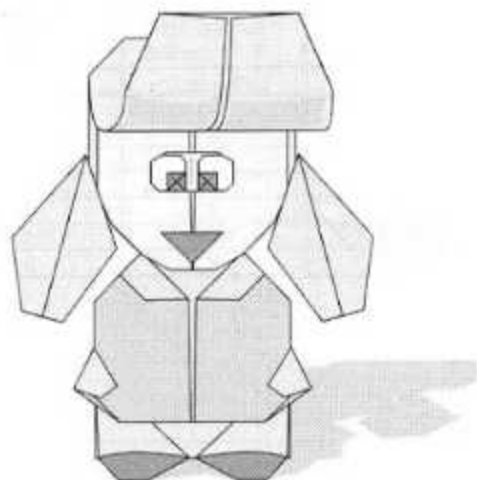

Utilizando las medidas recomendadas, se obtiene un modelo final de 10 cms.

| | |
|-----------------------------|-----------|
| Autor: | Halle |
| Nivel de dificultad: | Bajo |
| Número de piezas: | 6 |
| Forma de las piezas: | Cuadrados |

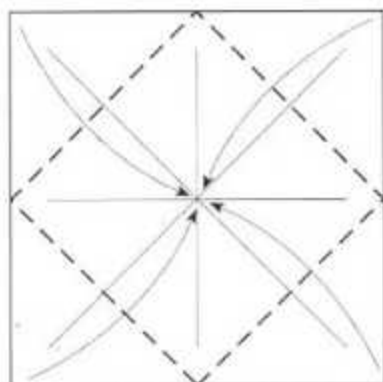

Rosa

15 cm

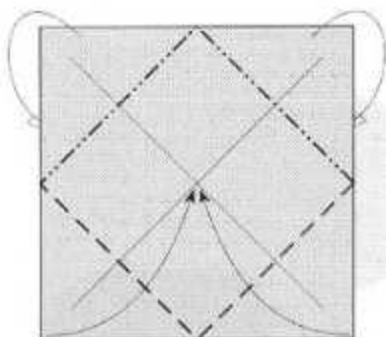

Naranja Verde

15 cm

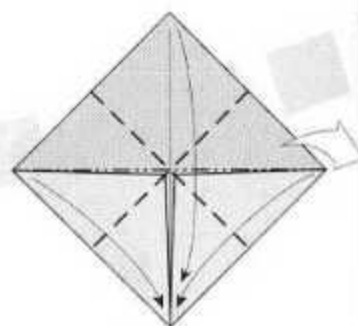

Verde Negro

10 cm

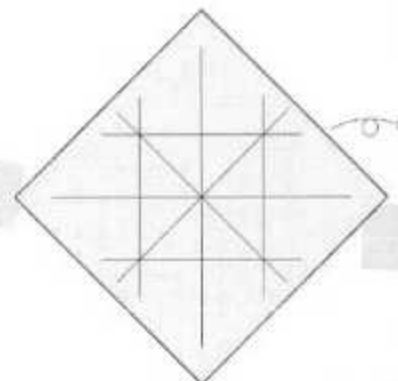
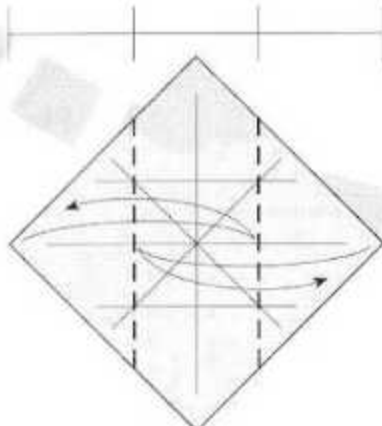
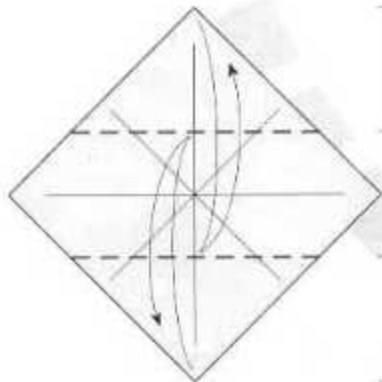
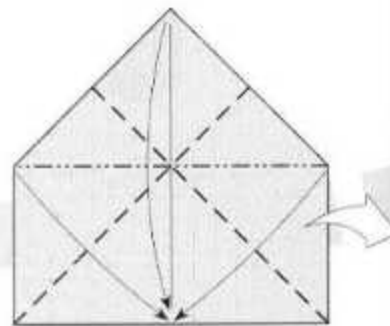
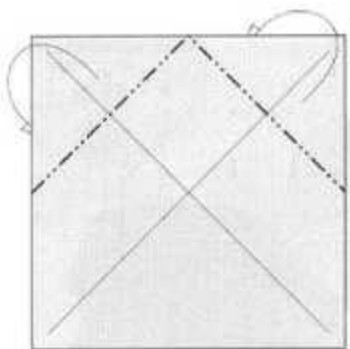
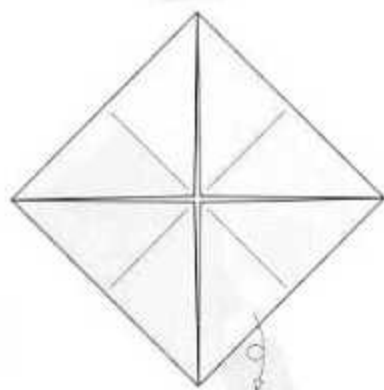

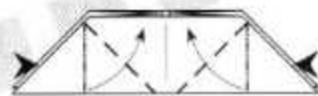
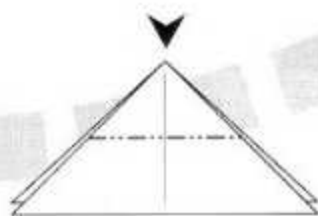
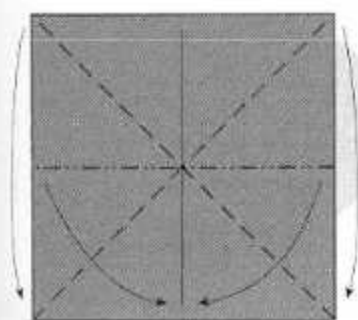
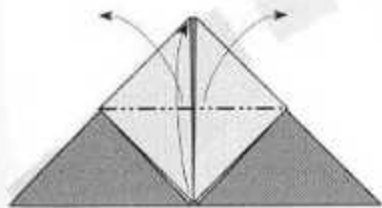
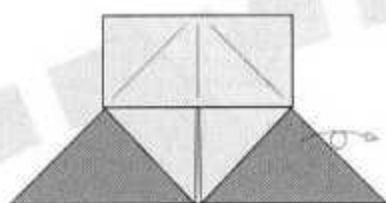
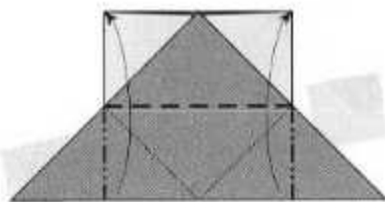
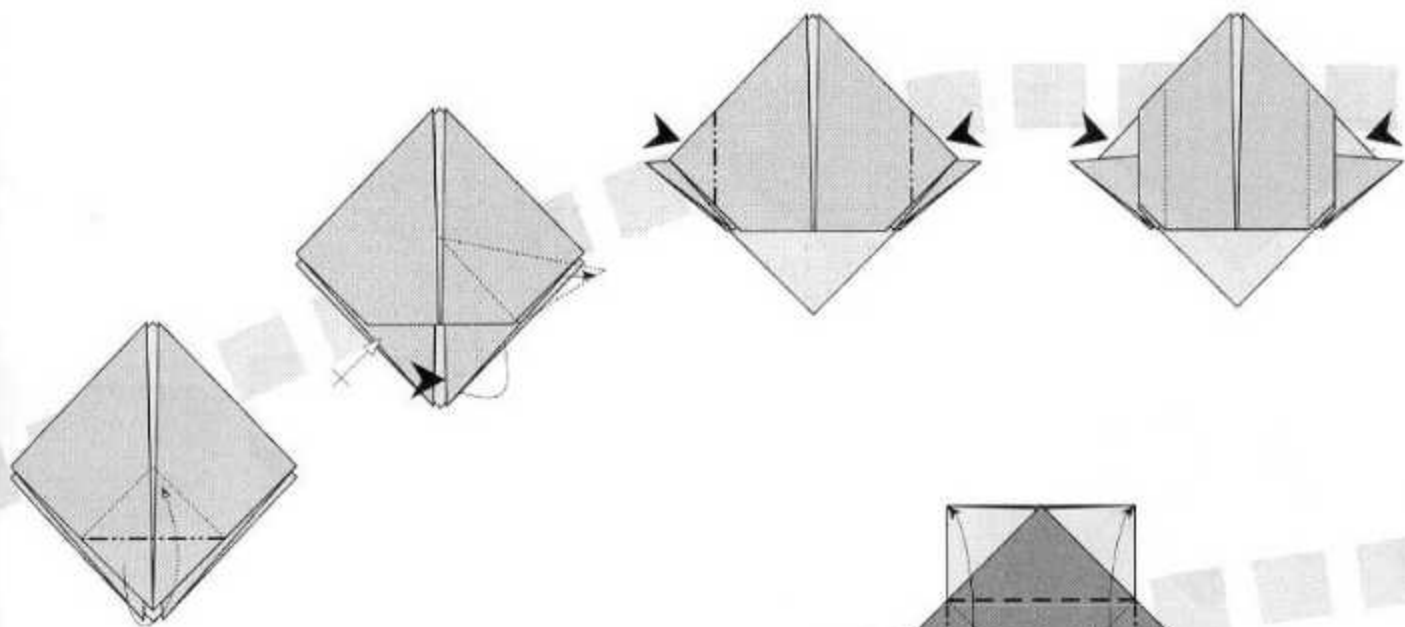

● Negro
○ Blanco

■ 5 cm
□ 5 cm

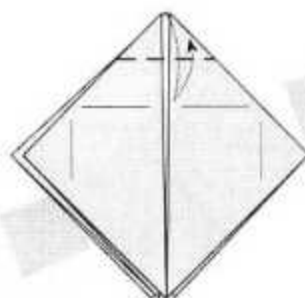
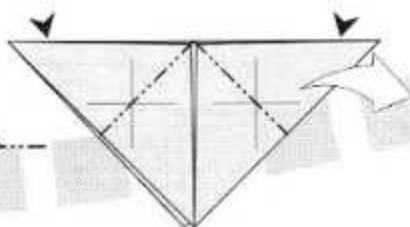
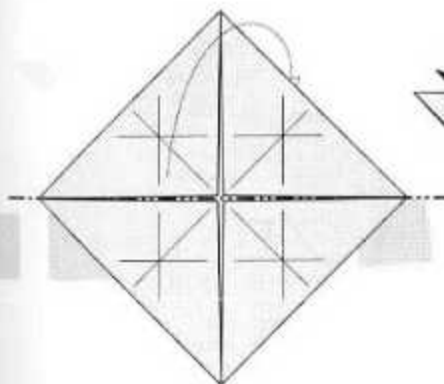

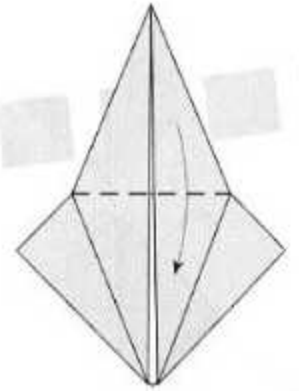
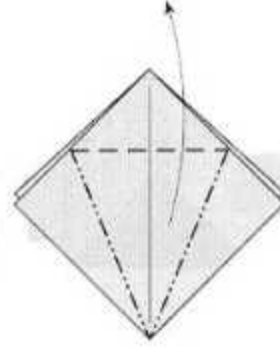
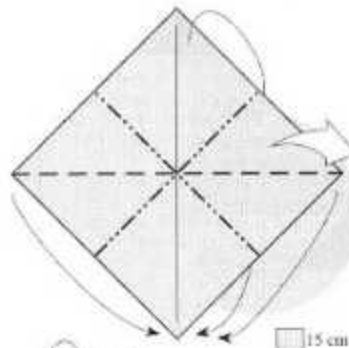
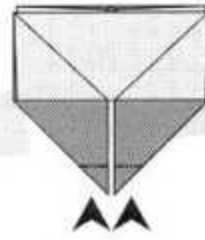
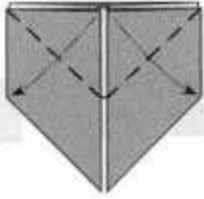
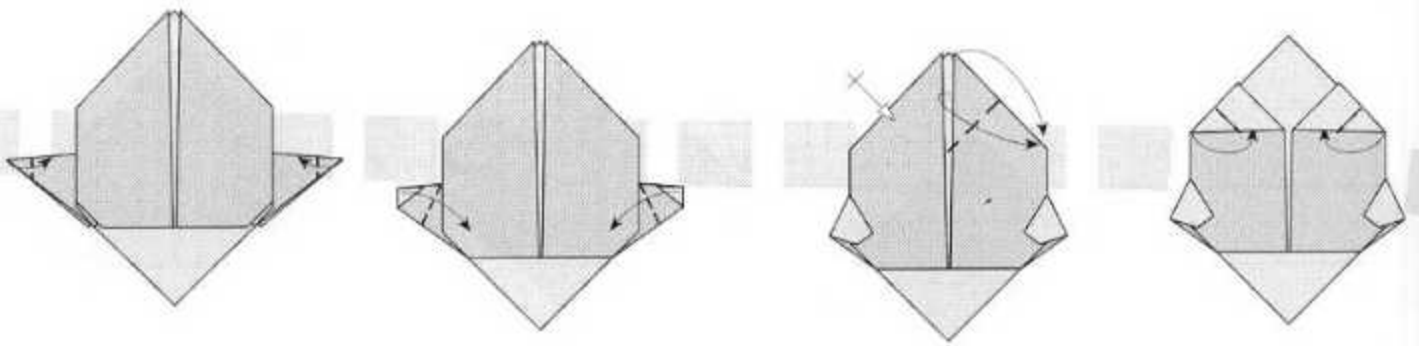

Verde

15 cm
15 cm

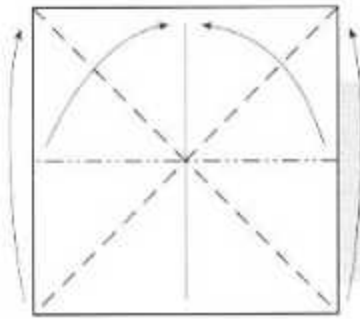

Negro

1,7 cm
1,7 cm

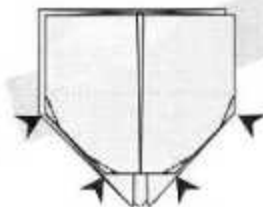
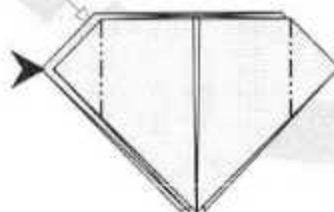
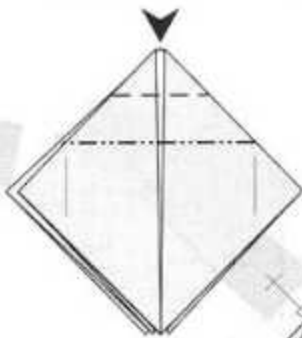
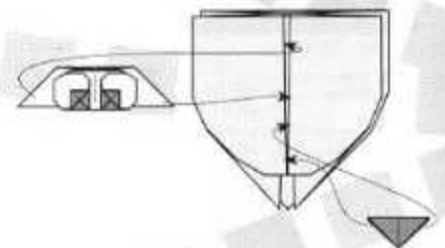

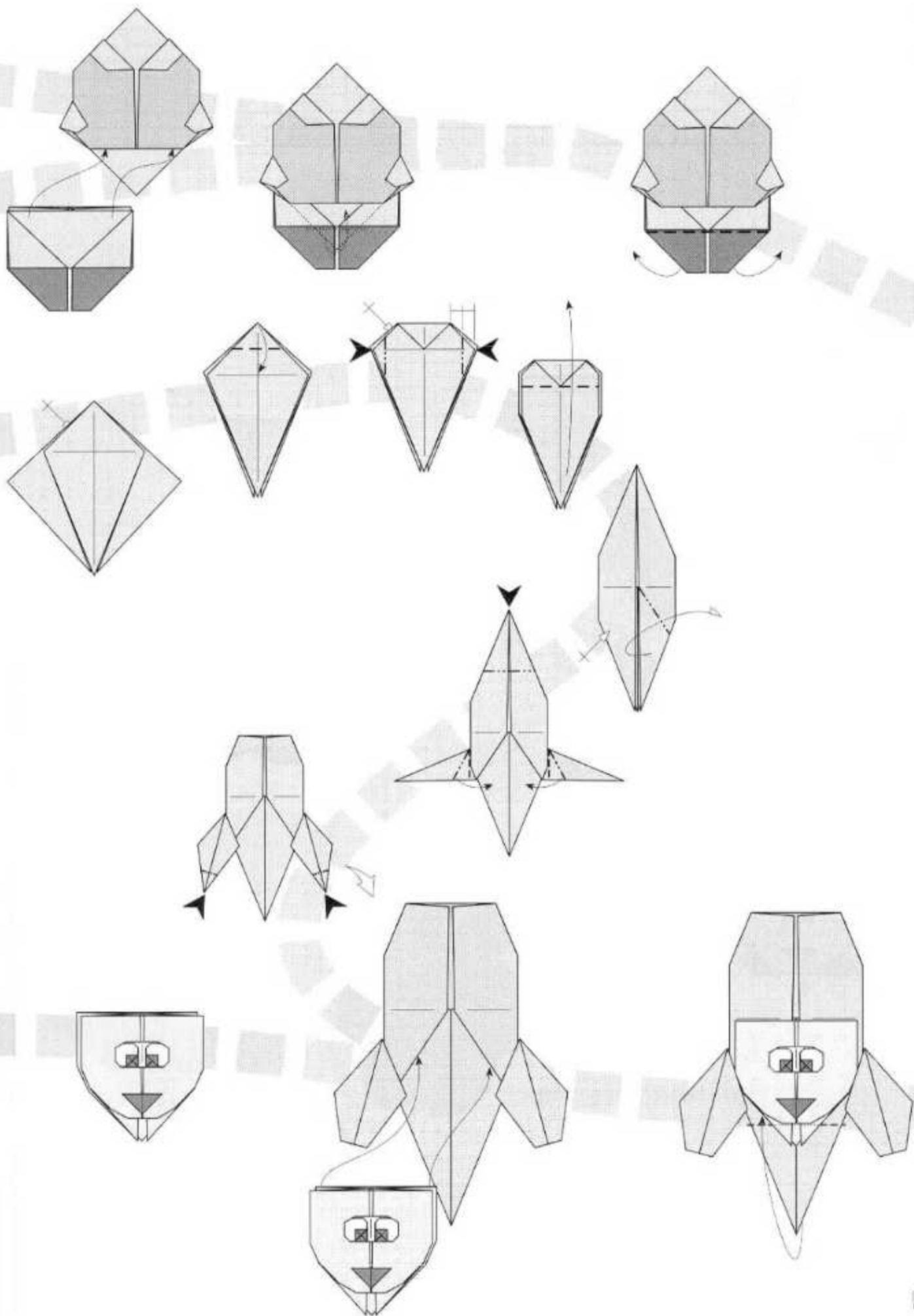

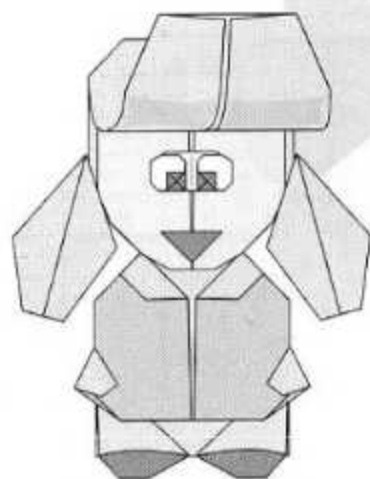
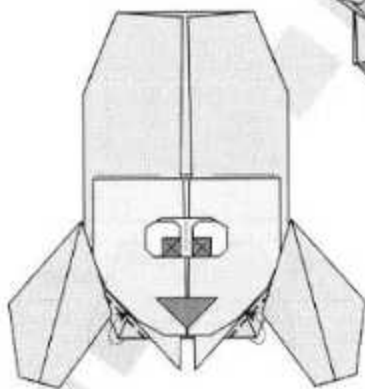
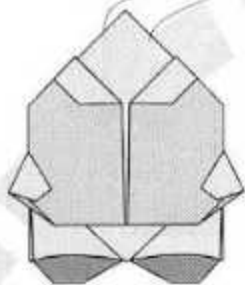
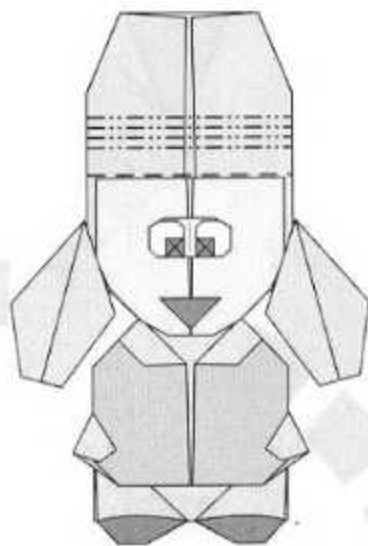
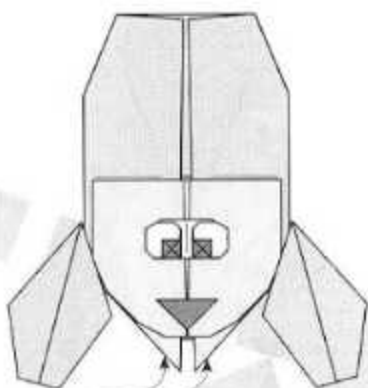
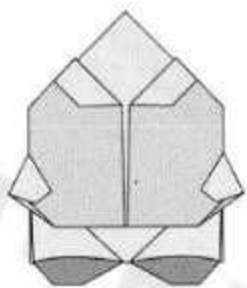

| Página (Desarr.) | Pieza nº | Cantidad | Porción | COLORES | | Tamaño original | Tamaño 3/10 | Tamaño 2/5 | Tamaño 3/5 |
|---------------------|----------|----------|-------------|----------|----------|-----------------|--------------|--------------|--------------|
| | | | | Anverso | Reverso | 10 cm alto | 3 cm alto | 4 cm alto | 6 cm alto |
| | | | | | | Lado (cm) = | Lado (cm) = | Lado (cm) = | Lado (cm) = |
| 130 | 1 | 1 | Cara | Neutro | Rosa | 15 | 4,5 | 6 | 9 |
| 130 | 2 | 1 | Gorro | Amarillo | Azul | 7 | 2,1 | 2,8 | 4,2 |
| 131 | 3 | 1 | Borla gorro | Neutro | Amarillo | 2,5 | 0,75 | 1 | 1,5 |
| 130 | 4 | 1 | Ojos | Negro | Blanco | 5 | 1,5 | 2 | 3 |
| 132 | 5 | 1 | Boca | Neutro | Negro | 1,7 | 0,51 | 0,68 | 1,02 |
| 132 | 6 | 2 | Cejas | Neutro | Negro | 1,7 | 0,51 | 0,68 | 1,02 |
| 131 | 7 | 1 | Cuerpo | Rojo | Amarillo | 15 | 4,5 | 6 | 9 |
| 130 | 8 | 1 | Pies | Marrón | Negro | 10 | 3 | 4 | 6 |



Plegado por: Nicolas Terry

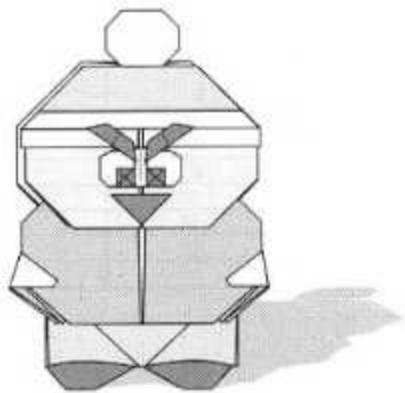

Utilizando las medidas recomendadas, se obtiene un modelo final de 10 cms.

| | |
|-----------------------------|-----------|
| Autor: | Halle |
| Nivel de dificultad: | Bajo |
| Número de piezas: | 9 |
| Forma de las piezas: | Cuadrados |

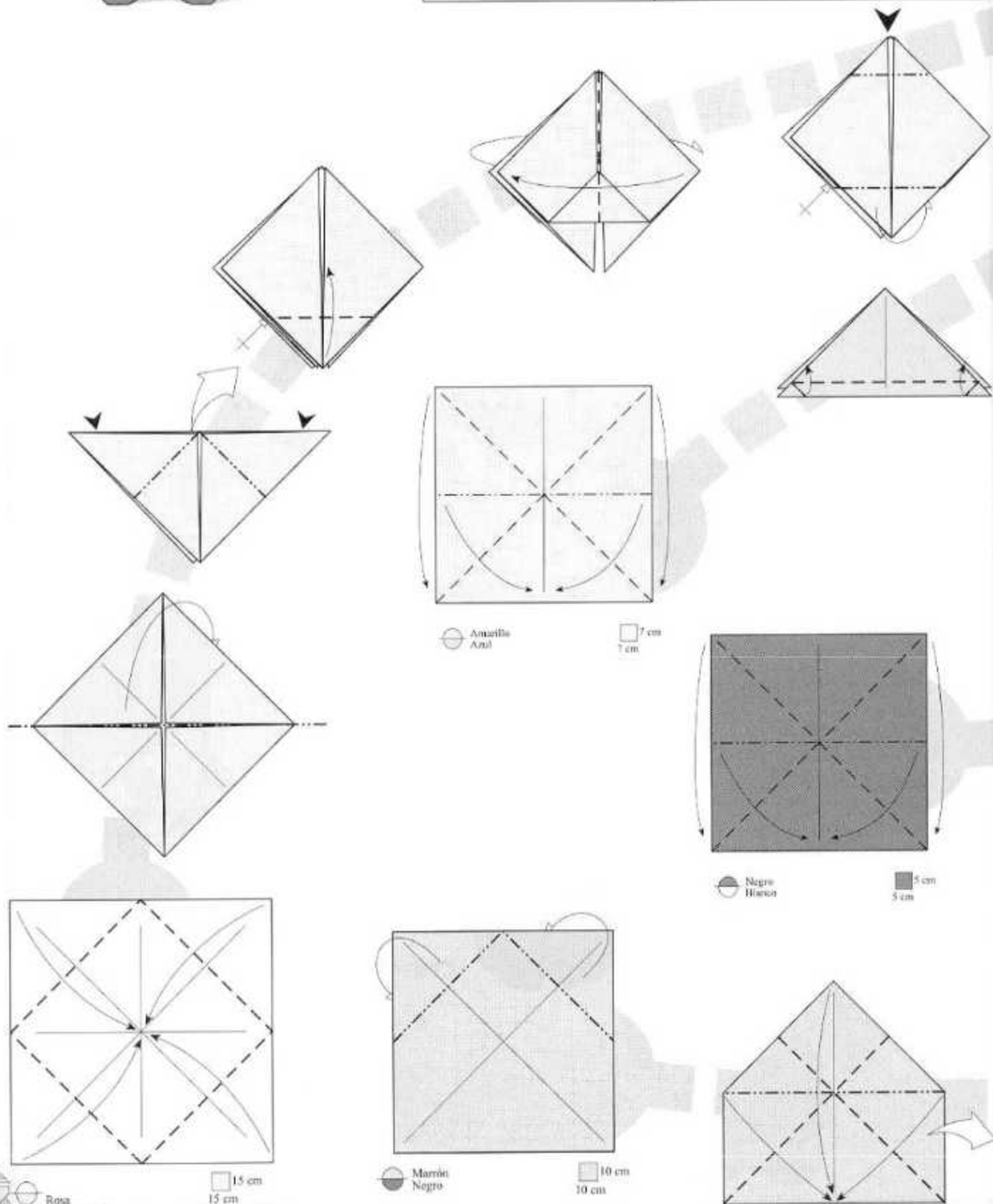

● Amarillo
● Azul

■ 7 cm
■ 7 cm

● Negro
● Blanco

■ 5 cm
■ 5 cm

● Marrón
● Negro

■ 10 cm
■ 10 cm

○ Rosa

■ 15 cm
■ 15 cm



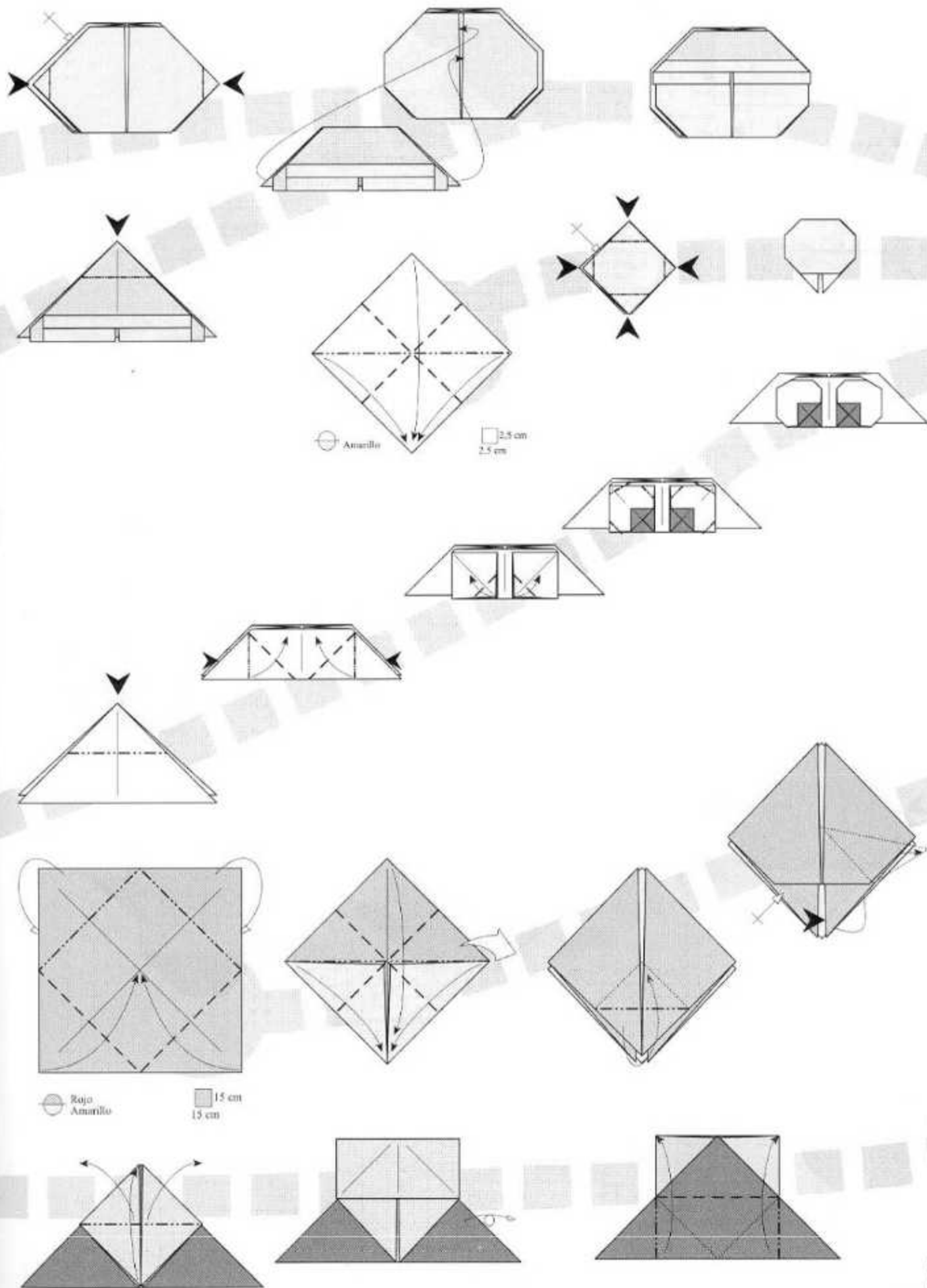

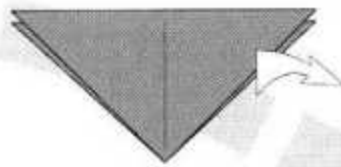
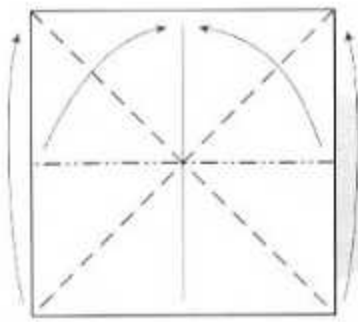

● Negro

■ 1,7 cm
1,7 cm

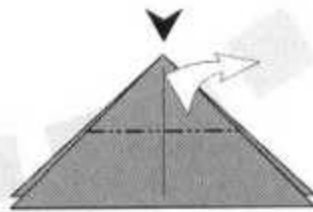
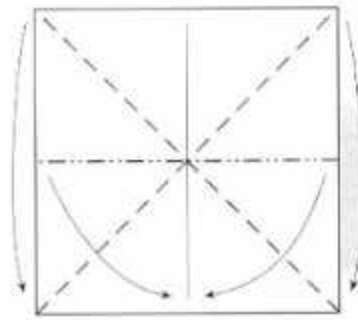
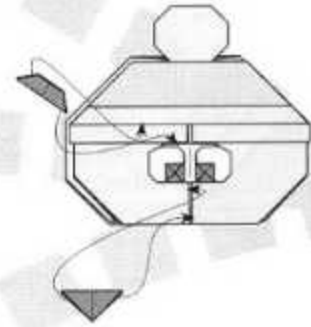
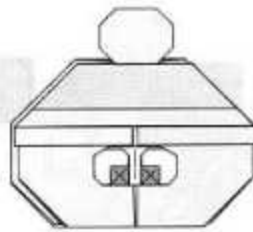
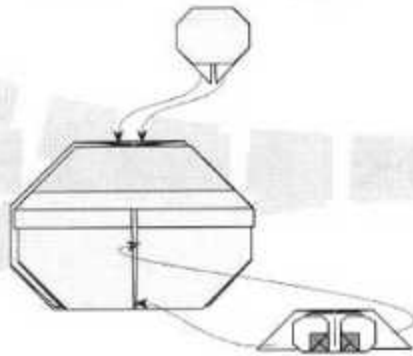

● Negro

■ 1,7 cm
1,7 cm

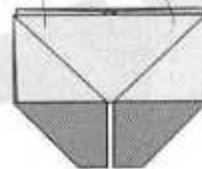
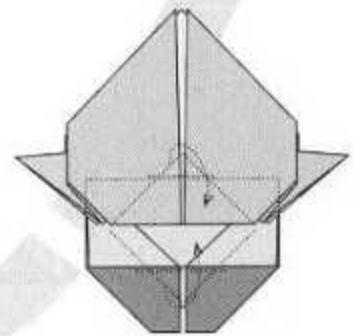
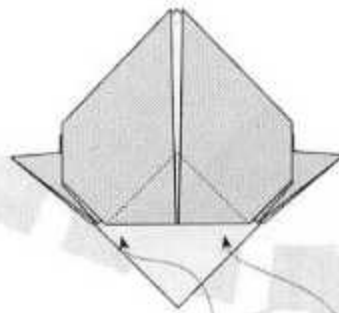
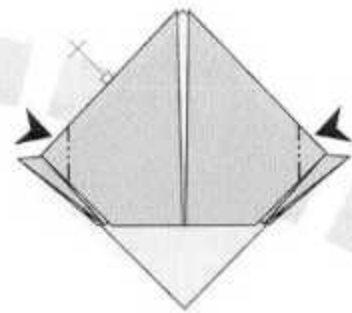
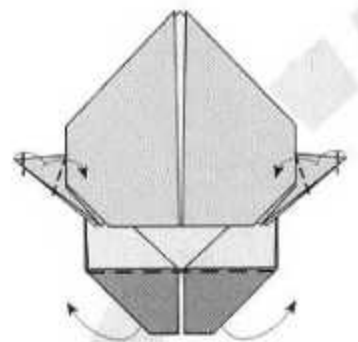

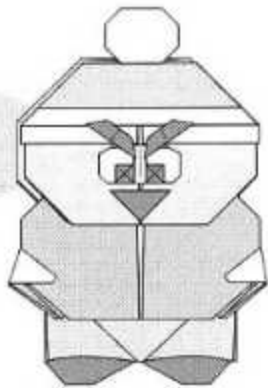
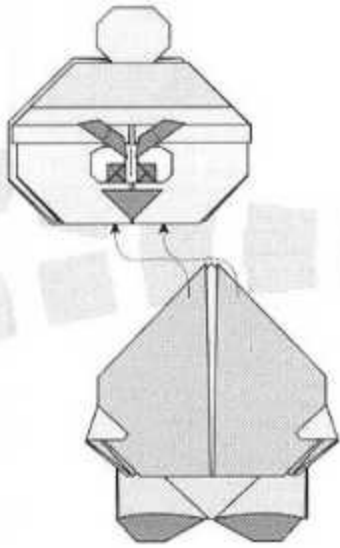

| Página | Pieza nº | Cantidad | Porción | COLORES | | Tamaño original | Tamaño 2/5 | Tamaño 3/5 | Tamaño 4/5 |
|--------|----------|----------|------------|---------|---------|-----------------|-------------|-------------|-------------|
| | | | | Anverso | Reverso | 15 cm alto | 6 cm alto | 9 cm alto | 12 cm alto |
| | | | | | | Lado (cm) = | Lado (cm) = | Lado (cm) = | Lado (cm) = |
| 135 | 1 | 1 | Cuerpo | Naranja | Marrón | 20 | 8 | 12 | 16 |
| 135 | 2 | 1 | Insignia-1 | Neutro | Azul | 5 | 6 | 9 | 12 |
| 135 | 3 | 1 | Base cara | Beige | Neutro | 11 | 4,4 | 6,6 | 8,8 |
| 136 | 4 | 1 | Piernas | Neutro | Azul | 10 | 4 | 6 | 8 |
| 136 | 5 | 1 | Ojos | Negro | Blanco | 3,75 | 1,5 | 2,25 | 3 |
| 136 | 6 | 1 | Cara | Marrón | Neutro | 15 | 6 | 9 | 12 |
| 137 | 7 | 1 | Insignia-2 | Neutro | Azul | 3 | 1,2 | 1,8 | 2,4 |
| 137 | 8 | 1 | Boca-1 | Negro | Neutro | 3,75 | 1,5 | 2,25 | 3 |
| 138 | 9 | 1 | Boca-2 | Neutro | Rojo | 1,5 | 0,6 | 0,9 | 1,2 |
| 139 | 10 | 1 | Antenas | Neutro | Negro | 7,5 | 3 | 4,5 | 6 |
| 139 | 11 | 1 | Casco | Bianco | Neutro | 15 | 6 | 9 | 12 |

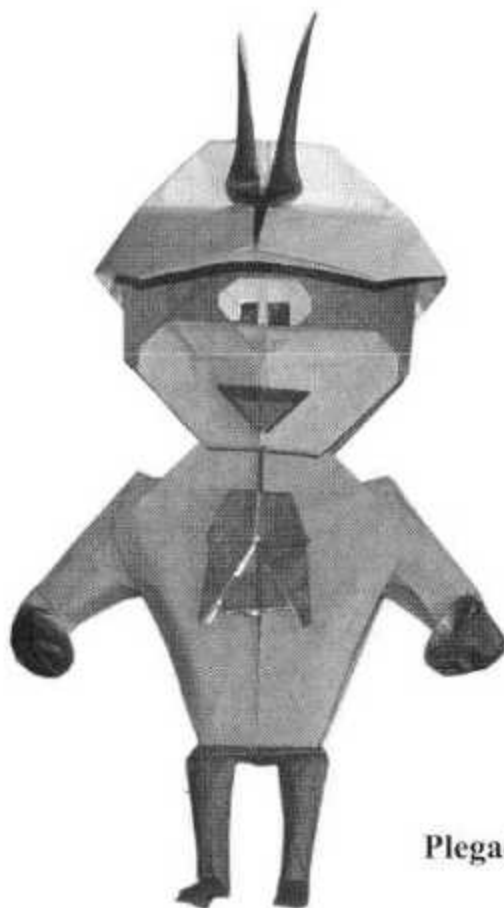

Plegado por: Halle

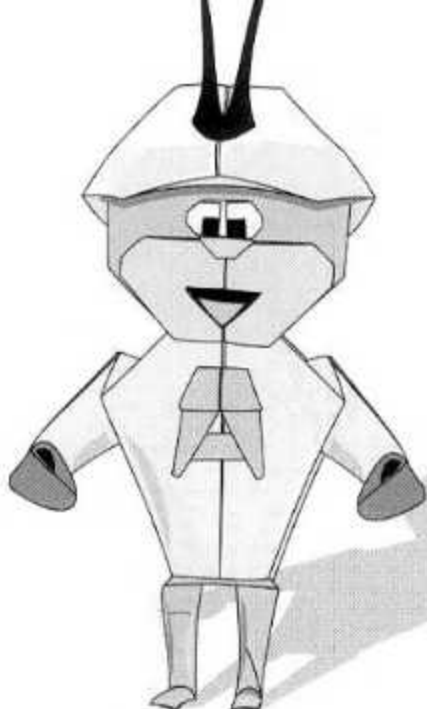

Utilizando las medidas recomendadas, se obtiene un modelo final de 15 cms.

| | |
|-----------------------------|-----------|
| Autor: | Halle |
| Nivel de dificultad: | Medio |
| Número de piezas: | 11 |
| Forma de las piezas: | Cuadrados |

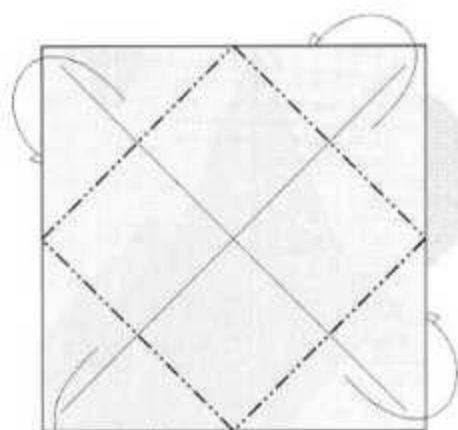

Naranja
Marrón

20 cm
20 cm

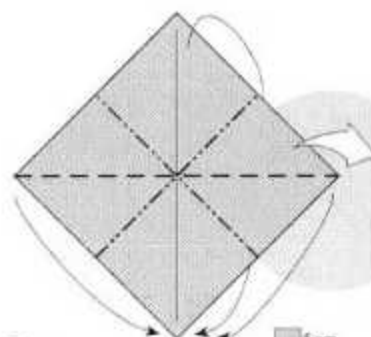
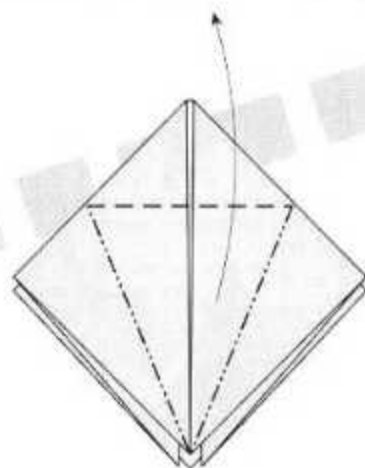
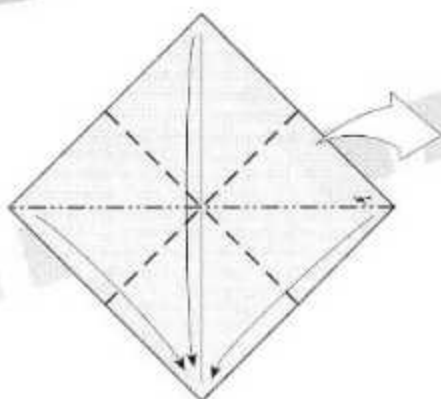

Azul

5 cm
5 cm

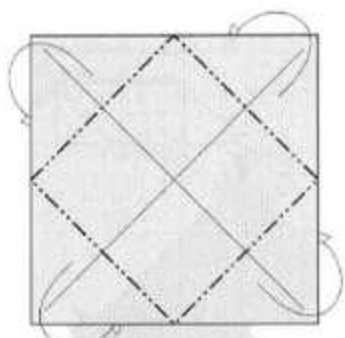
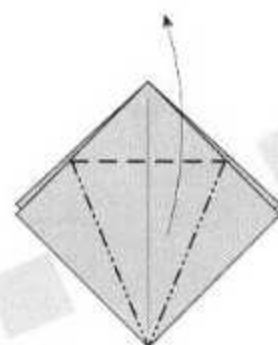

Beige

11 cm
11 cm

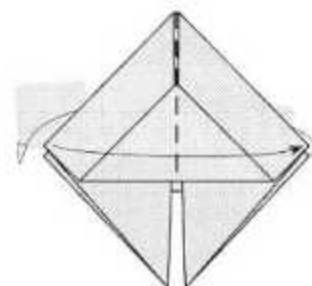
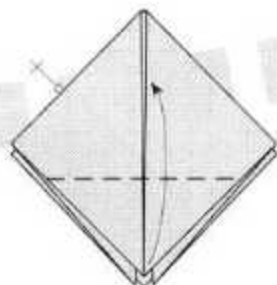
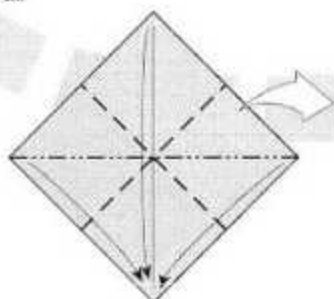

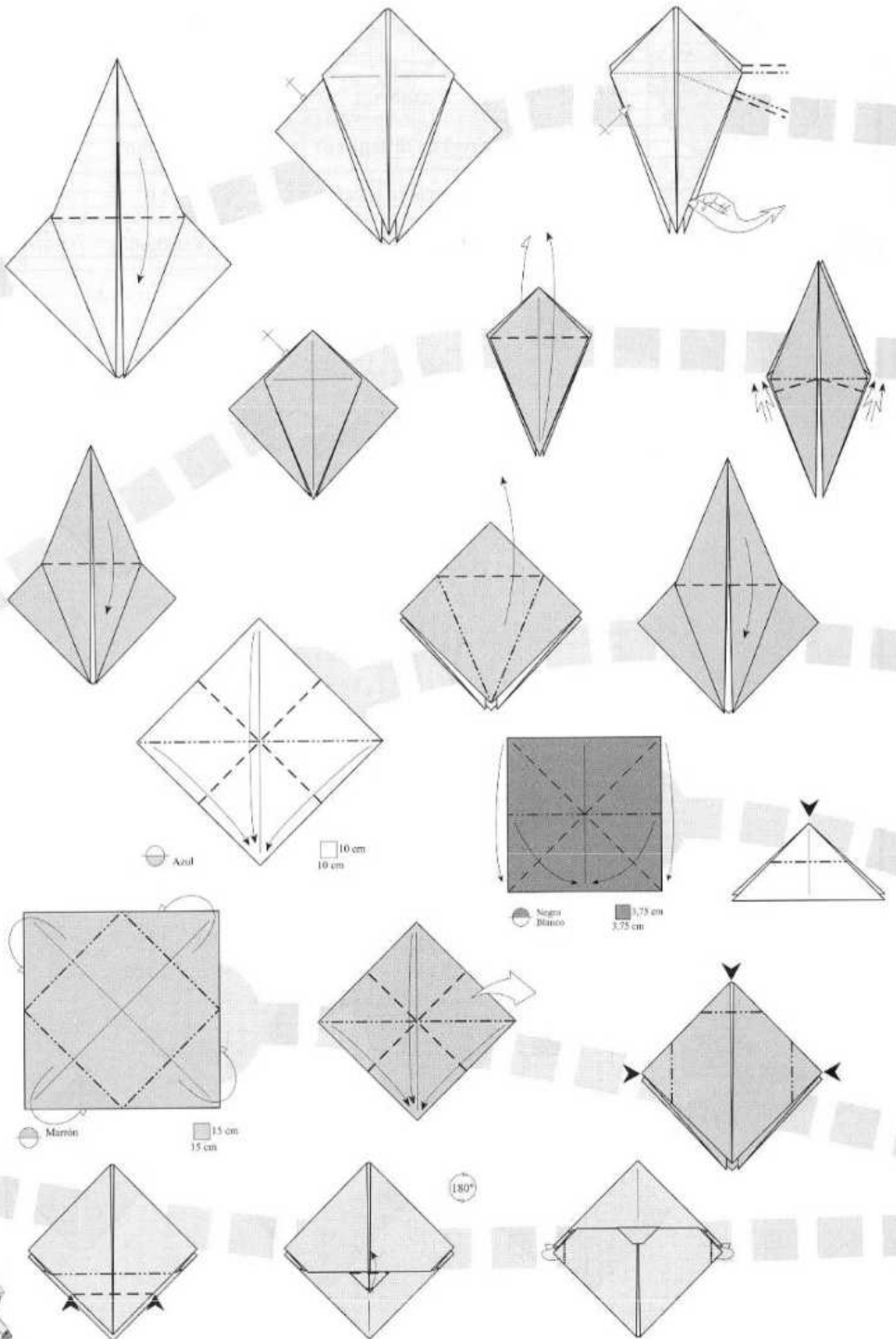

● Azul

□ 10 cm
10 cm

● Negro
● Blanco

■ 3.75 cm
3.75 cm

● Marrón

■ 15 cm
15 cm

180°



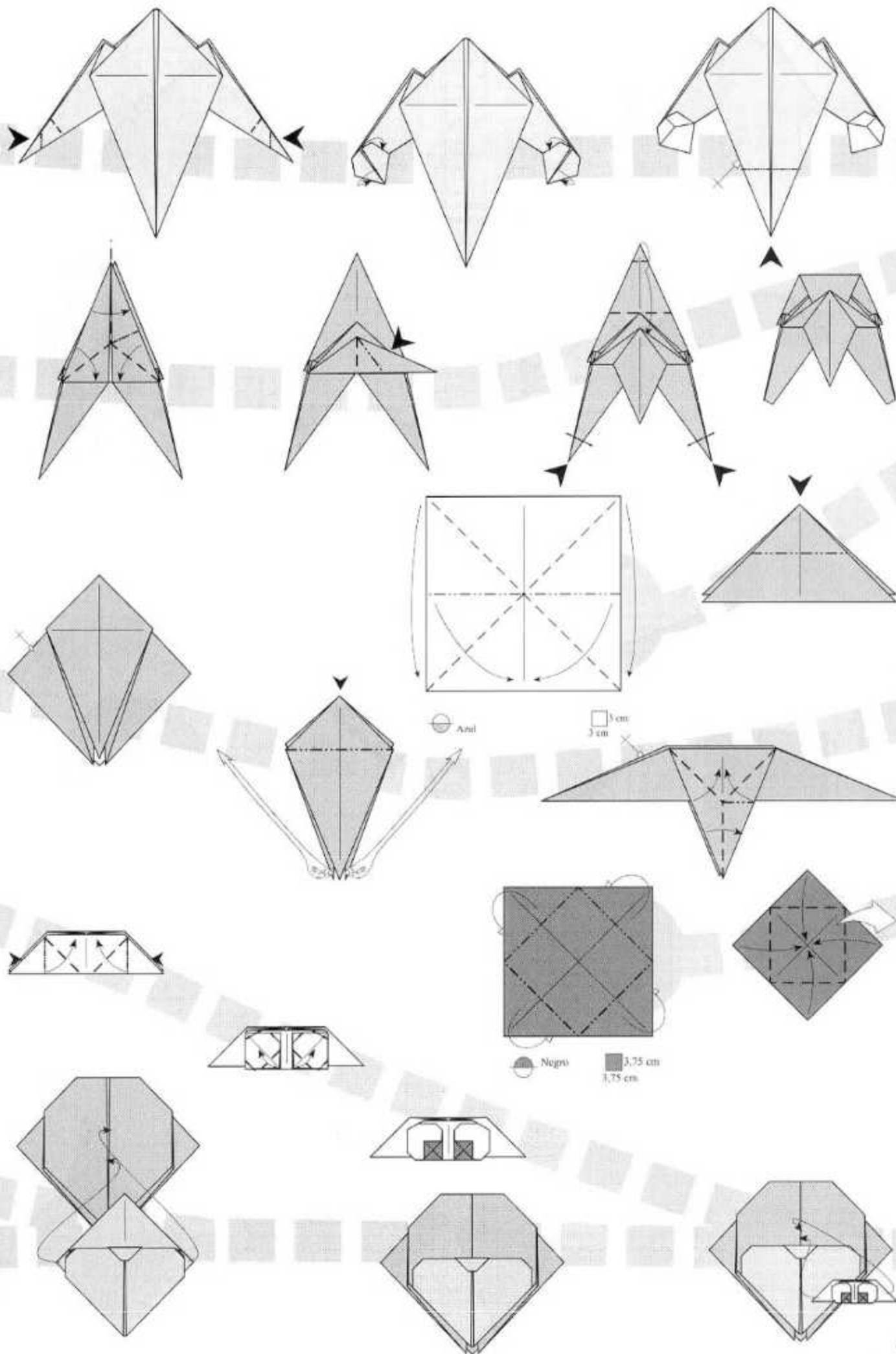

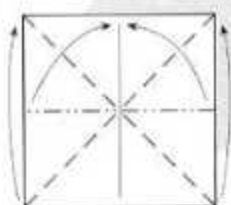
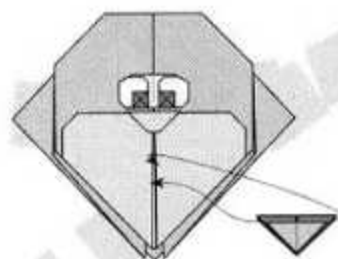
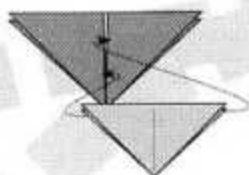
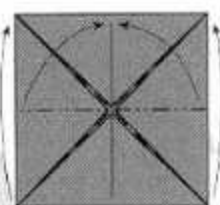
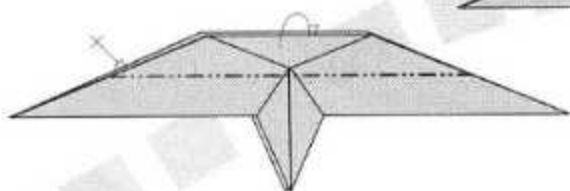
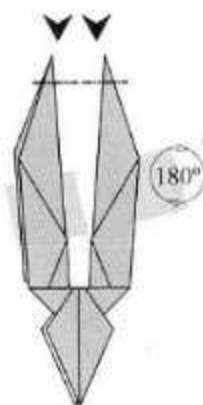
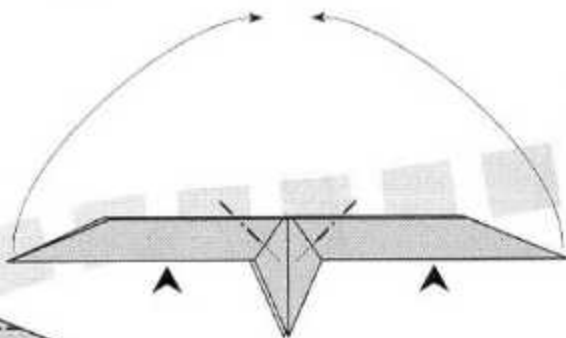
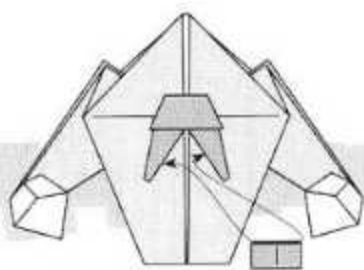
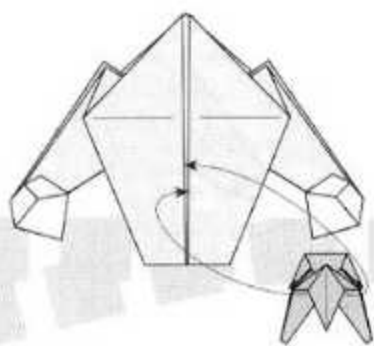

Rosa



1,5 cm
1,5 cm

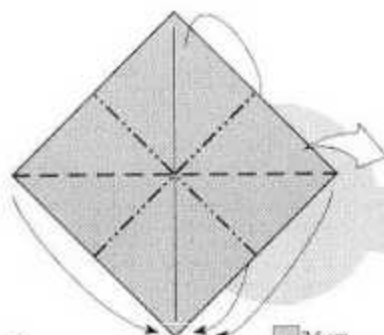
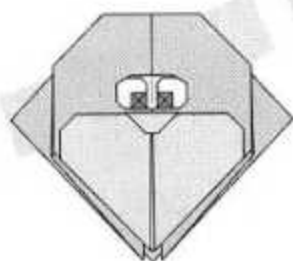

Rosa

7,5 cm
7,5 cm

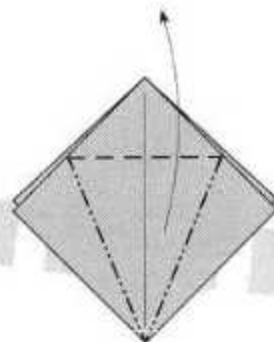

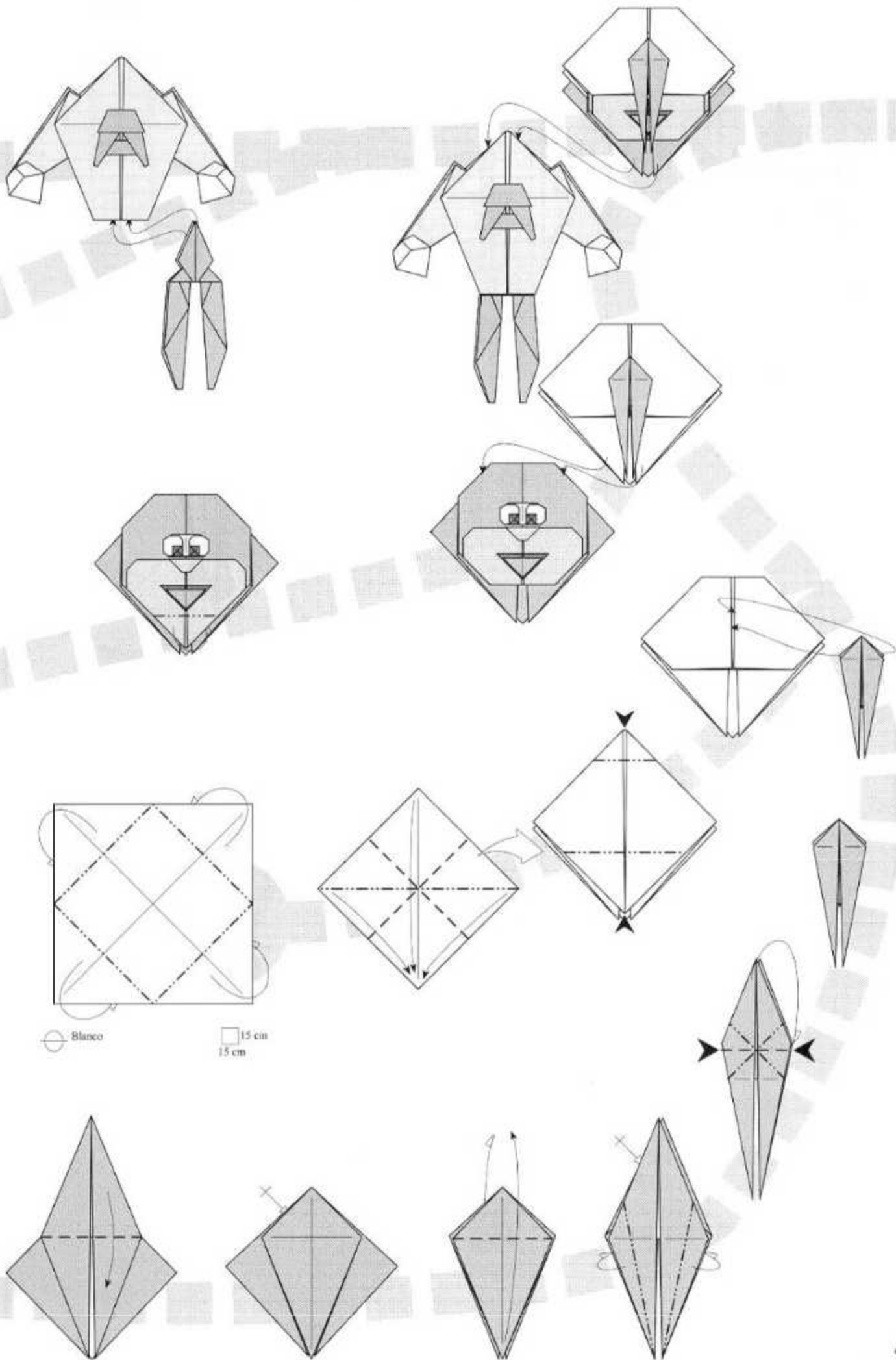

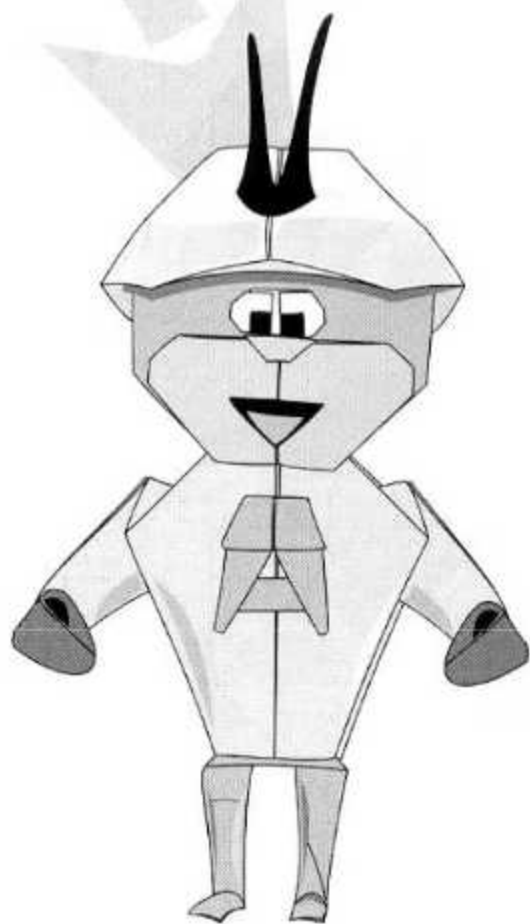
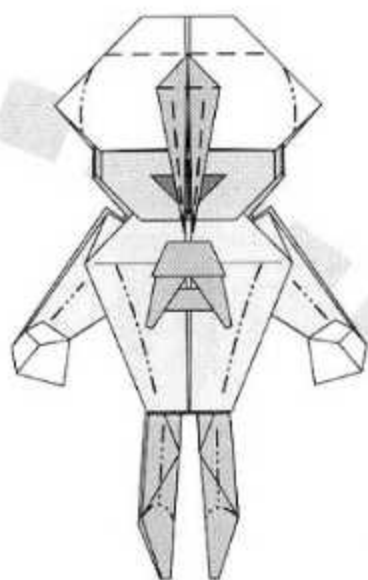
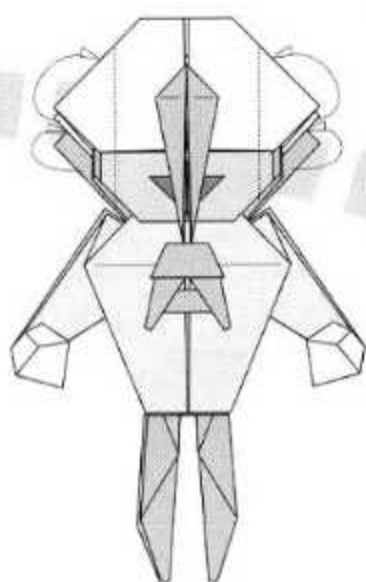

| Página (Desarr.) | Pieza nº | Cantidad | Porción | COLORES | | Tamaño original | Tamaño 3/10 | Tamaño 2/5 | Tamaño 3/5 |
|---------------------|----------|----------|--------------|----------|---------|-----------------|-------------|-------------|-------------|
| | | | | Anverso | Reverso | 18 cm alto | 5.5 cm alto | 7 cm alto | 11 cm alto |
| | | | | | | Lado (cm) = | Lado (cm) = | Lado (cm) = | Lado (cm) = |
| 142 | 1 | 1 | Base cabeza | Beige | Negro | 15 | 4,5 | 6 | 9 |
| 144 | 2 | 2 | Cara | Neutro | Beige | 10 | 3 | 4 | 6 |
| 144 | 3 | 1 | Ojos | Negro | Bianco | 5 | 1,5 | 2 | 3 |
| 147 | 4 | 1 | Morro | Neutro | Beige | 15 | 4,5 | 6 | 9 |
| 148 | 5 | 1 | Nariz | Neutro | Negro | 2,5 | 0,75 | 1 | 1,5 |
| 142 | 6 | 1 | Camisa/manos | Amarillo | Bianco | 20 | 6 | 8 | 12 |
| 142 | 7 | 1 | Capa | Naranja | Naranja | 15 | 4,5 | 6 | 9 |
| 146 | 8 | 1 | Cinturón | Neutro | Negro | 5 | 1,5 | 2 | 3 |
| 146 | 9 | 1 | Capa | Neutro | Negro | 5 | 1,5 | 2 | 3 |
| 142 | 10 | 2 | Patas | Amarillo | Naranja | 15 | 4,5 | 6 | 9 |



Plegado por: Halle

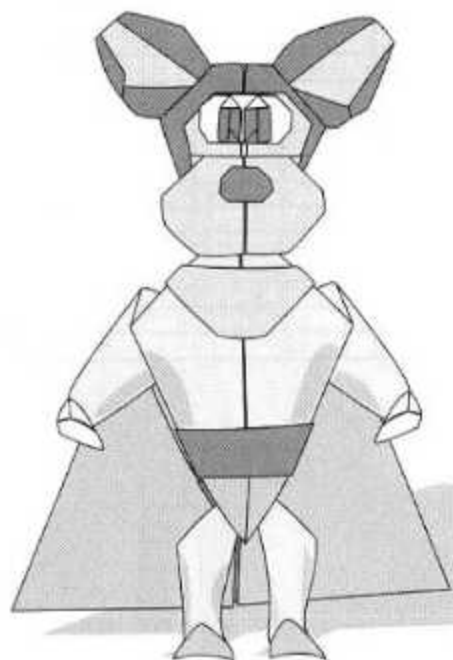

Utilizando las medidas recomendadas, se obtiene un modelo final de 18 cms.

| | |
|-----------------------------|-----------|
| Autor: | Halle |
| Nivel de dificultad: | Medio |
| Número de piezas: | 12 |
| Forma de las piezas: | Cuadrados |

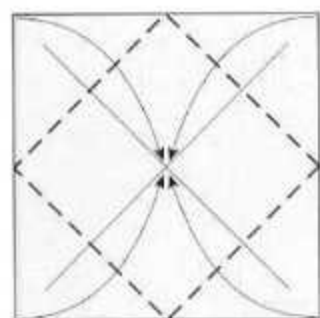

● Beige
● Negro

□ 15 cm
□ 15 cm

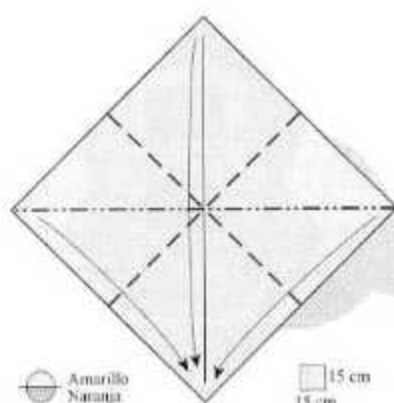
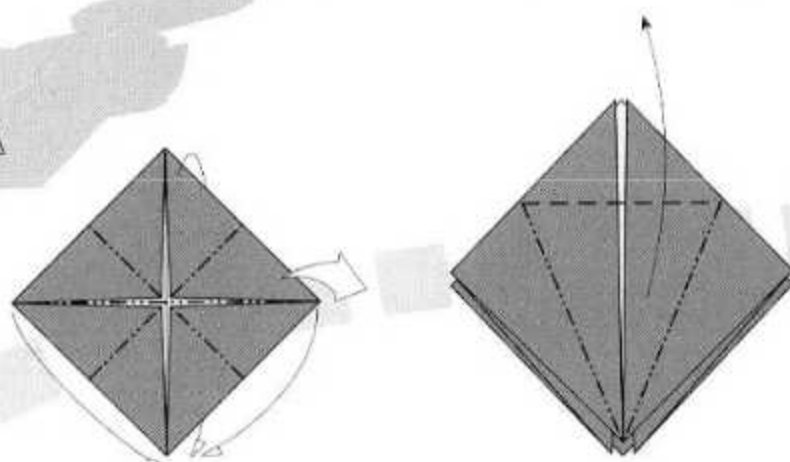

● Amarillo
● Naranja

□ 15 cm
□ 15 cm

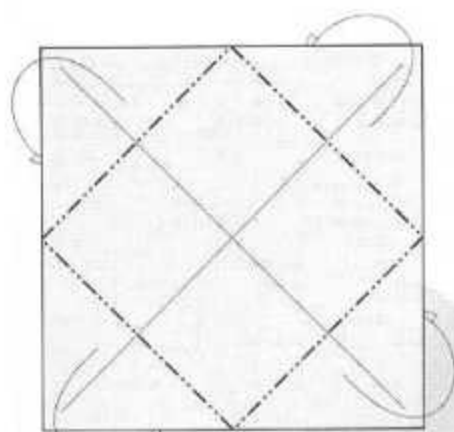
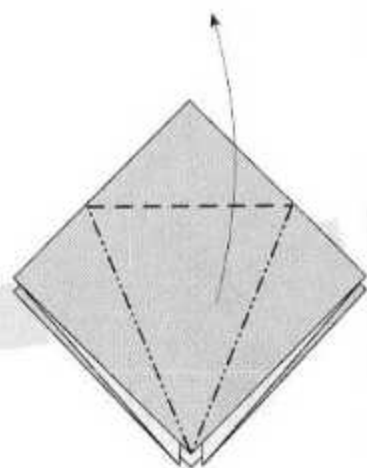

● Amarillo
● Blanco

□ 20 cm
□ 20 cm

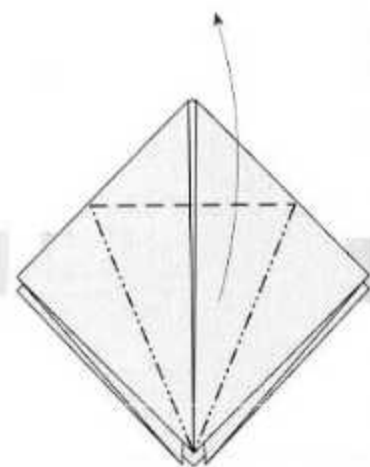
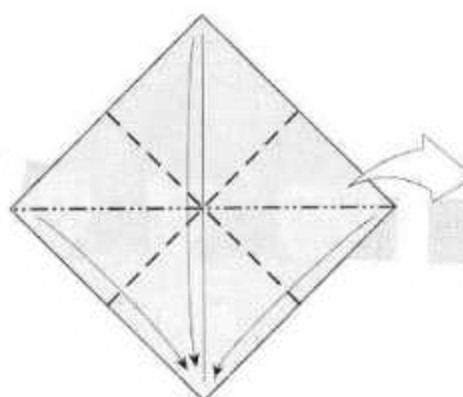

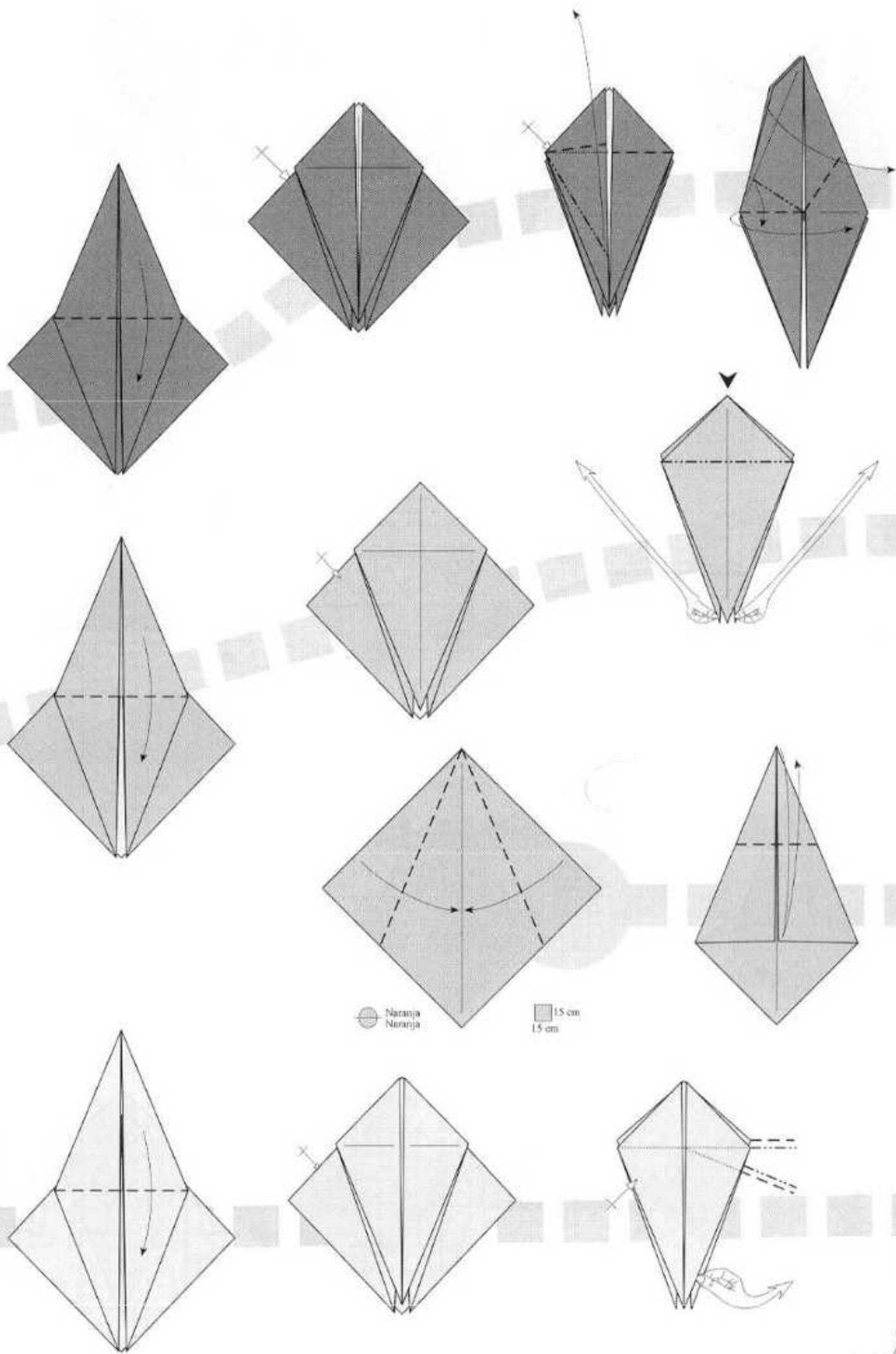



 Narraja
 Narraja

 15 cm
 15 cm

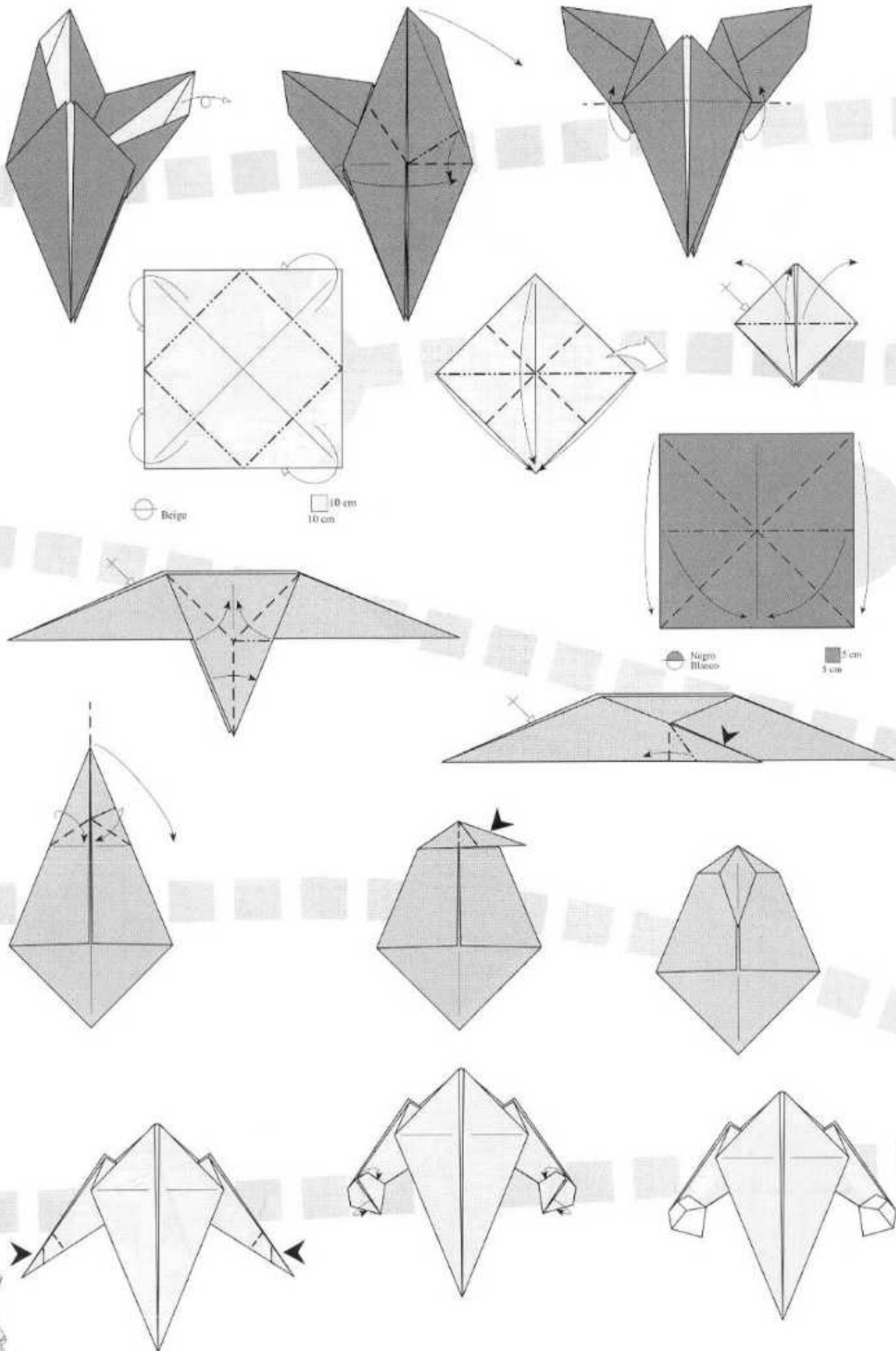

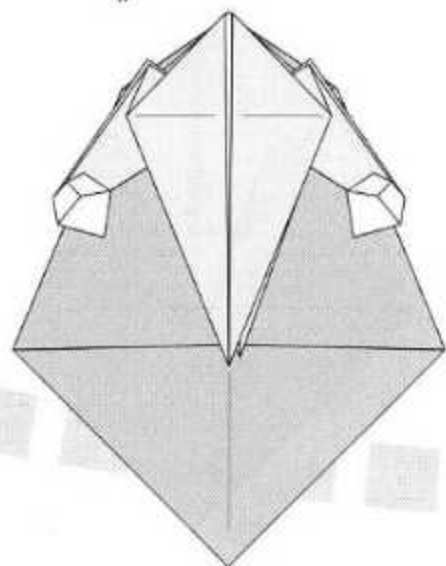
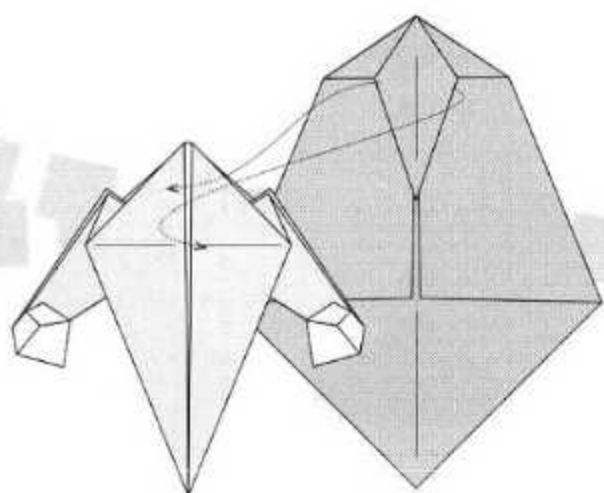
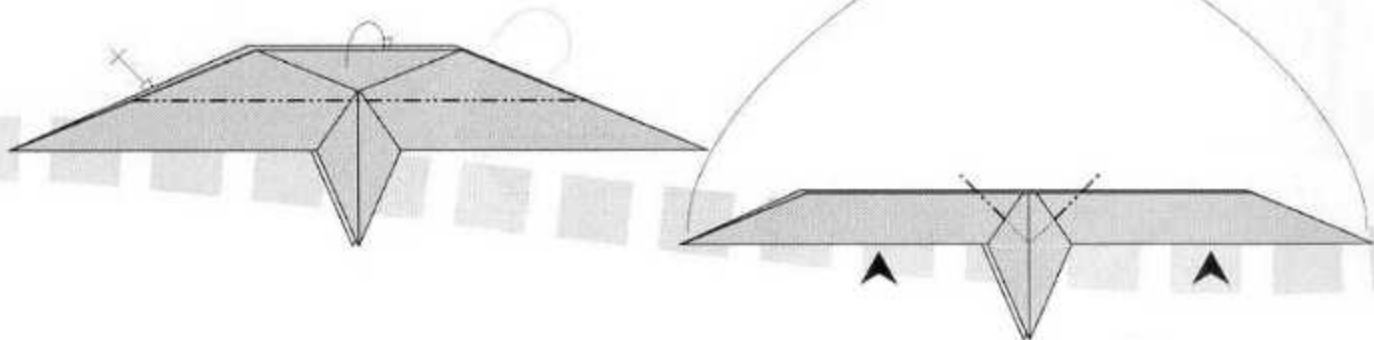
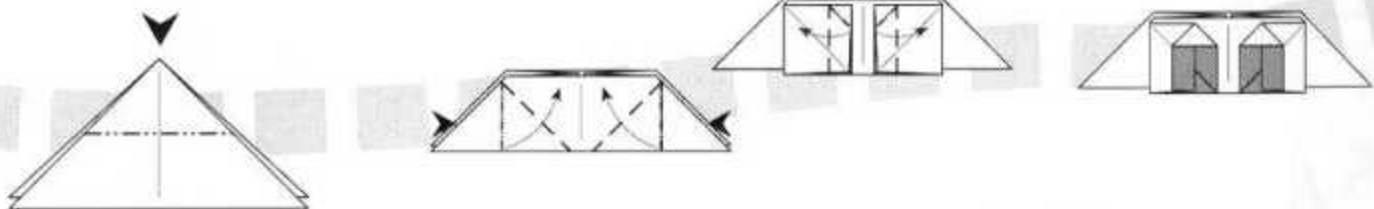
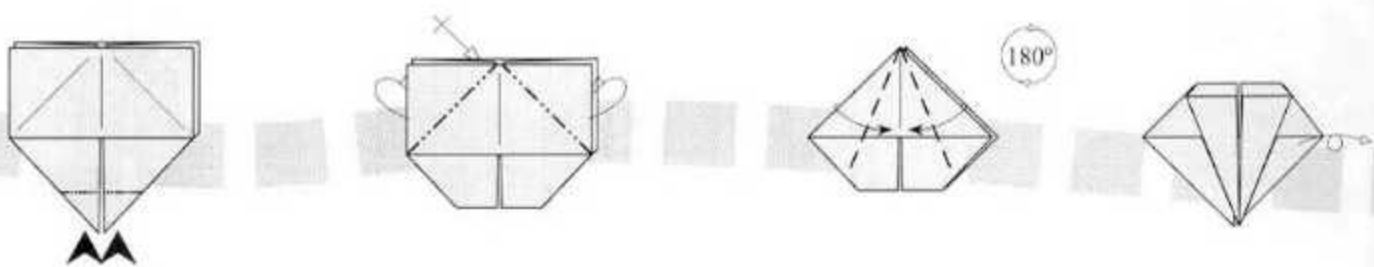
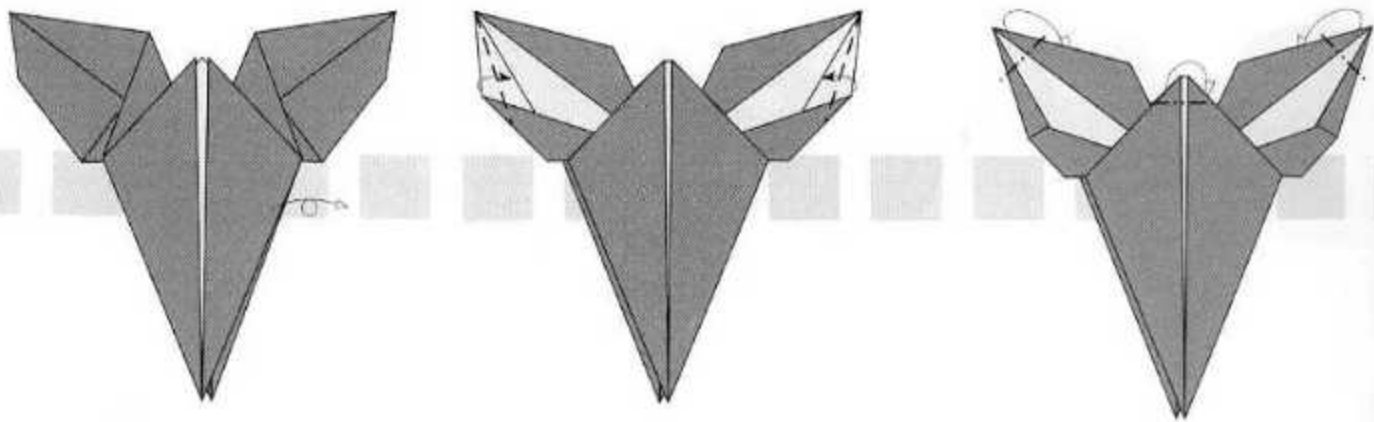

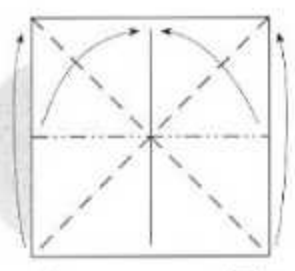
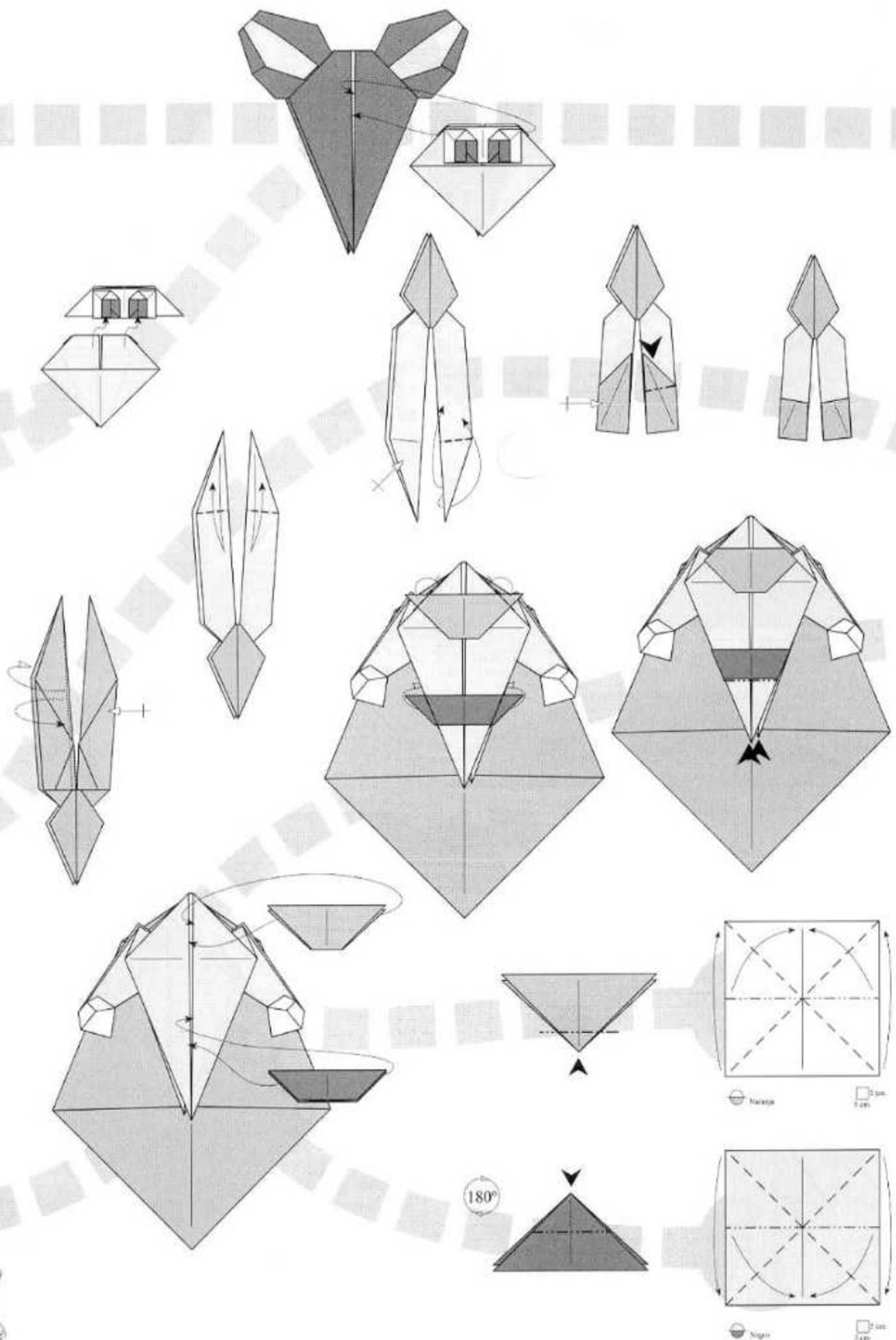



Sign 1 cm

180°

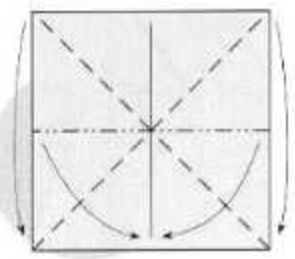
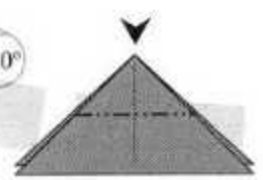

Sign 1 cm



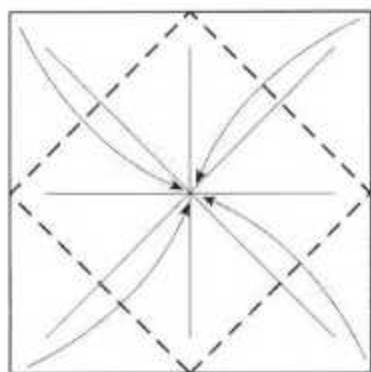
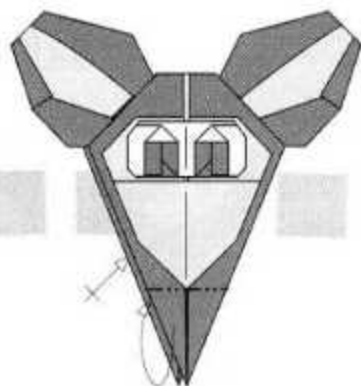
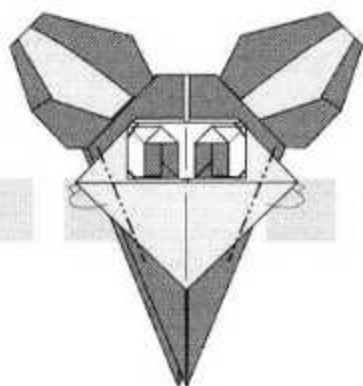

Beige

15 cm
15 cm

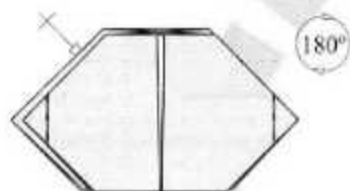
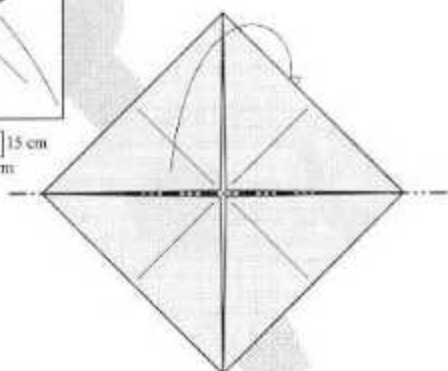

180°

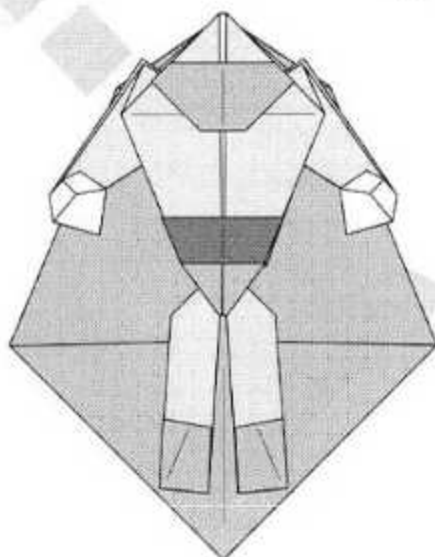
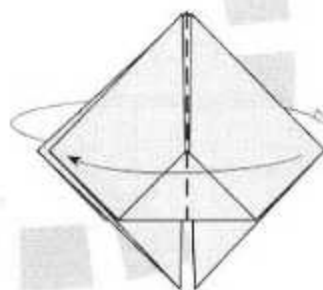
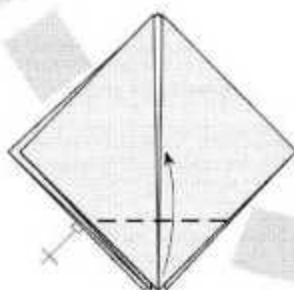
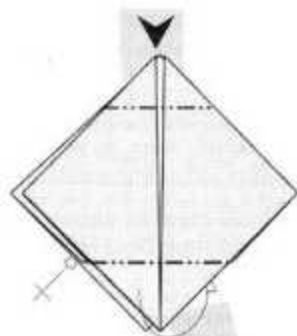
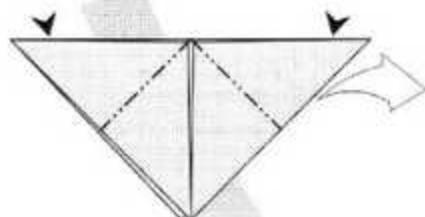
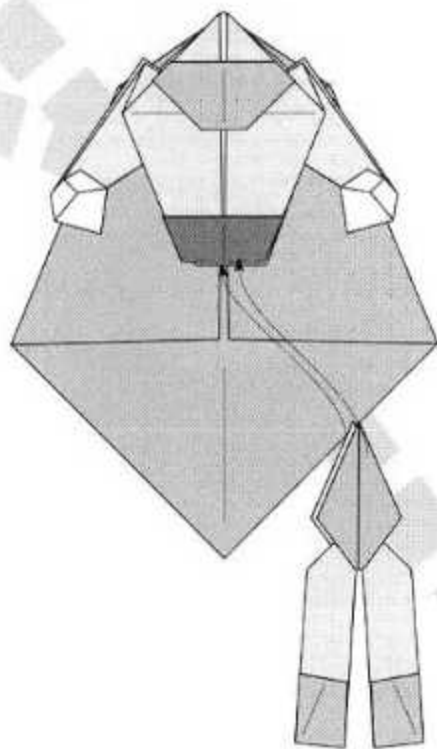

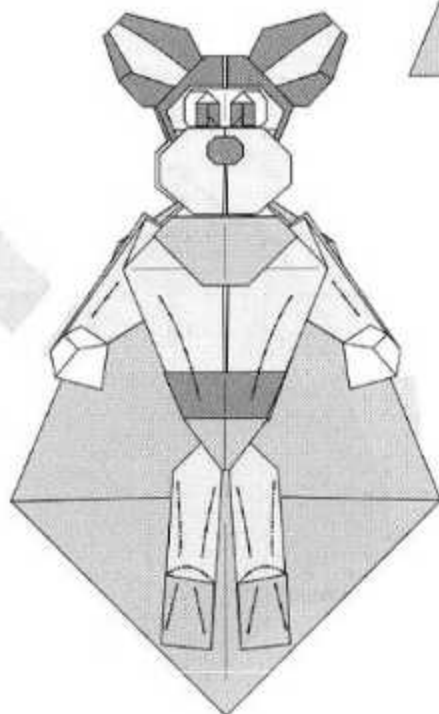
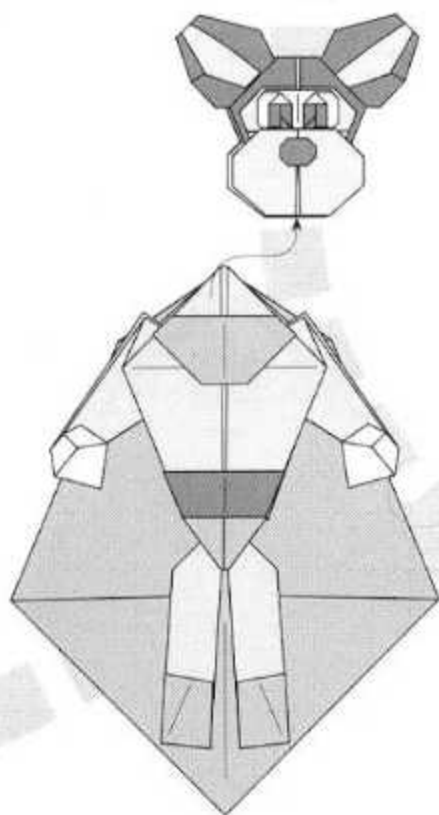
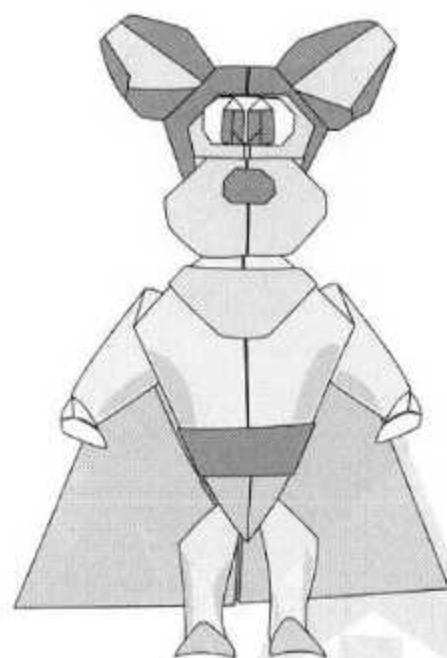
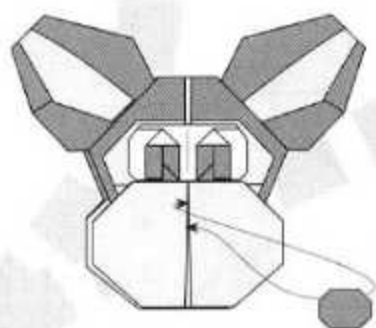
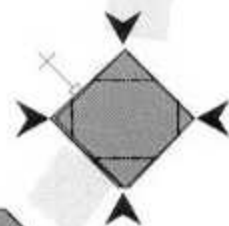
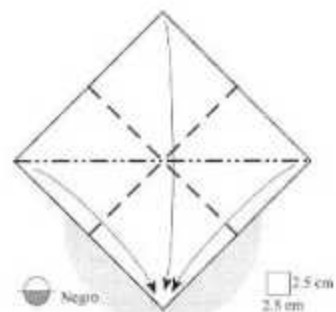
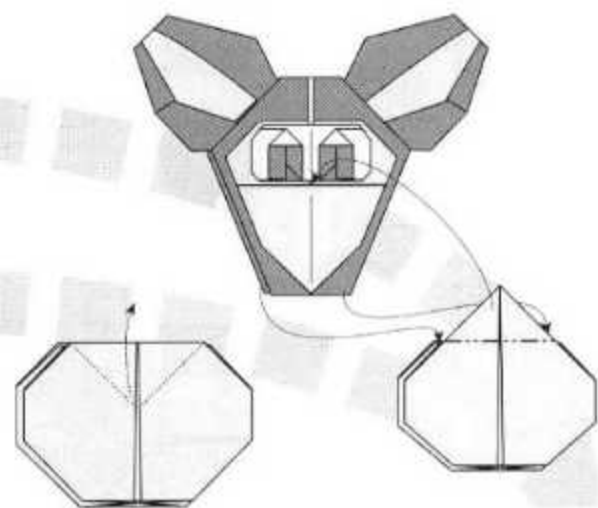

CREANDO CARTOONS

By Halle

Mi más sincero agradecimiento a Alfredo Pérez Jiménez por sus consejos y matizaciones a la hora de redactar este artículo, y a José Anibal Voyer por las ilustraciones que lo acompañan.

- I) **INTRODUCCIÓN**
- II) **PROCESO DE CREACIÓN**
- III) **ASPECTOS FINALES**



I) **INTRODUCCIÓN**

Desde que nació mi primer "cartoon" en papiroflexia, (una versión personal de la pantera rosa), han sido varias las personas y los foros en los que me han invitado a explicar cómo y cuál es mi proceso de creación.

En este artículo trataré de exponer mi "modus operandi", sin que esto quiera decir que lo lleve a cabo al pie de la letra. En absoluto. Mi lema es que si hay algo hermoso en el fascinante mundo de la creación es la libertad para no ceñirse a regla alguna y dejarse únicamente guiar por la intuición y la inspiración; sólo así creo que puede llegarse a conseguir un estilo propio... al menos es lo que intento.

Considero que "crear", salvo quizás para los genios, no es un proceso que se adquiera de un día para otro. Personalmente me parece que es una cuestión de tiempo y de que surja interiormente el deseo de inventar figuras propias. Es difícil explicar la sensación que produce, sólo se que me envuelve, se me va el tiempo sin sentir y, sobre todo, me relaja.

Pasé mucho tiempo plegando modelos de otros creadores antes de que apareciese ese deseo y, cuando lo hizo, llevaba aparejado el que debía consistir en la búsqueda de algo diferente, en lugar de sumarme a la creación de modelos clásicos, tales como dinosaurios, insectos, animales, etc.

Quiero decir con esto que tenía ya un buen camino recorrido: dominaba las bases tradicionales y por otro lado, tal como dice Juan Gimeno, había "leído" mucha papiroflexia, que consiste en examinar cuidadosamente las figuras de los diagramas sin tan siquiera realizar un solo pliegue, es decir, imaginando el proceso y la construcción del modelo mentalmente.

Pero paso a exponer sin más preámbulos la parte principal de este escrito.

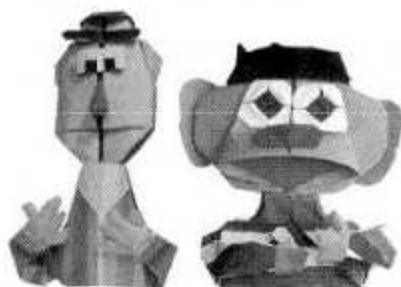

II) **PROCESO DE CREACIÓN**

En el proceso de creación de modelos nuevos, actúo según los siguientes parámetros:

- 1) Determino en principio qué es lo que quiero crear y realizo un dibujo del modelo resaltando las partes fundamentales y todo tipo de detalles que definen la personalidad o añaden vida a la figura.
- 2) Una vez dibujado el modelo, pienso en las posibles piezas necesarias para construirlo, las asocio a bases tradicionales y desecho todos aquellos detalles que pudieran resultar superficiales.
- 3) Determinadas las diferentes piezas, empiezo a trabajar en ellas, comenzando por la que considero más difícil y que suele coincidir con la que más define el "alma" del personaje.
- 4) Al ir progresando en la construcción, voy determinando los tamaños relativos de los cuadrados de papel, de forma que las proporciones de las distintas partes, sean las adecuadas.
- 5) Finalmente, analizo e intento conseguir las uniones de las piezas.

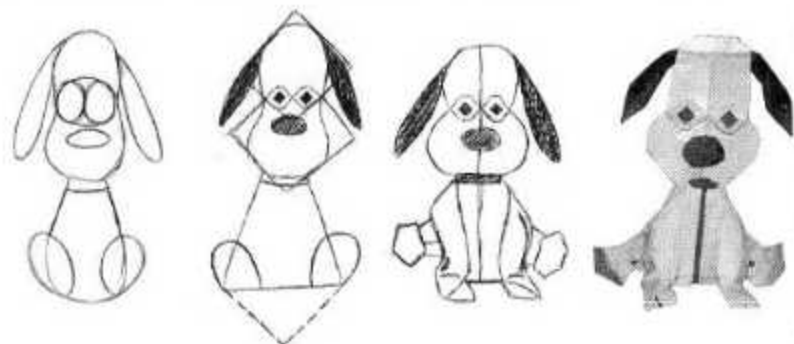

Para la realización del dibujo inicial, utilizo la técnica del diseño basado en círculos y elipses y así, paso a elaborar un pequeño boceto, por ejemplo del adorable Piolín



Esta técnica de dibujo artístico es muy sencilla y admite muchas posibilidades.

Posteriormente, defino con más detalle el dibujo inicial hasta tener bien claro qué es lo que deseo crear.



La parte más importante del modelo viene definida normalmente por la cara. Conseguir una expresión que transmita dulzura, simpatía, que haga reír... lo considero muy importante.

Al crear puede suceder que la combinación de piezas y colores o proporciones me sugiera más de un personaje. Como ejemplo sirvan las caras del orondo Homer Simpson y la del enigmático Kenny.

Realmente son piezas idénticas, una base preliminar y una pájaro engarzadas de igual manera, pero con la combinación de colores y la diferencia en proporciones obtengo resultados bien distintos.

La cabeza consta, normalmente, de dos orejas, dos ojos, la base de la cara... es decir, se precisan demasiadas puntas como para resolverlo utilizando una sola base sencilla. Debo "sacrificar" alguna parte de la cabeza para hacerla en otra pieza... es cuestión de imaginación, inspiración, suerte...

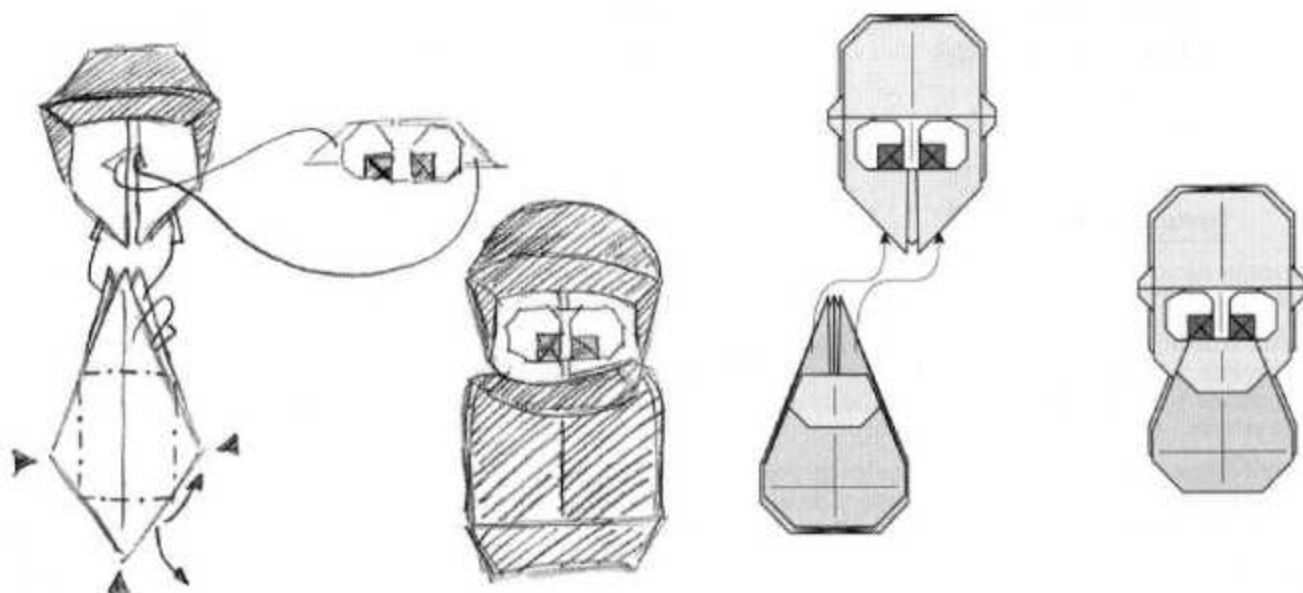

A veces me construyo las bases tradicionales y juego con ellas como si de un puzzle se tratará. La simple superposición de éstas me da un buen resultado, como en la cara de este ratoncito, que está creada a través de una mezcla de casi todas las bases sencillas (Preliminar, bomba y pájaro).

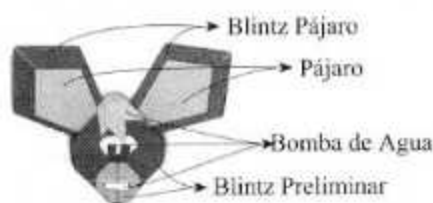

Con todo ello quiero dar a entender que lo que intento en todo momento es dejarme llevar por la intuición y lo que dicte mi imaginación, prescindiendo de cualquier restricción apriorística.

Para el cuerpo, mi base preferida es la blintz pájaro pues al dejar un "raíl" en la mitad de la pieza, consigo una ayuda adicional para realizar las uniones posteriores, sobre todo con las extremidades.

La utilización de esta base, también me permite conseguir a menudo el cambio de color.

Debo fijarme bien en el modelo y en función de la constitución de éste, es fácil hacerlo más robusto o más estilizado:

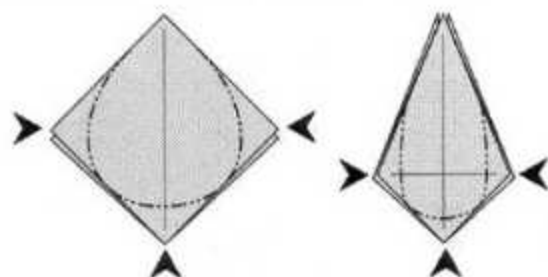
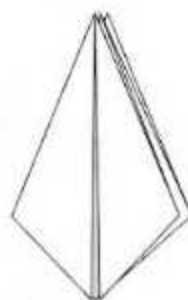

Conseguir insuflar volumen a la figura unas veces me resulta más fácil y otras más difícil. La simple superposición de planos horizontales y verticales en el espacio ya ayuda bastante. Formar las articulaciones conduce a un mayor realismo.

He llegado a la conclusión de que, frecuentemente, es mejor simular determinadas partes del cuerpo que intentar crear las piezas. Por ejemplo, los dedos de las manos, en determinadas ocasiones, tienen

un mejor acabado con un suave plegado, que si intento crearlos uno a uno. A efectos de plegado me ayudo con un pequeño alicate, consejo que recibí de mi amigo Anibal Voyer.

A través de la utilización de distintas piezas obtengo la ventaja adicional de poder dar mayor colorido a mis creaciones, lo que me lleva a conseguir una mayor vistosidad y una figura más alegre.

Tampoco se trata de abusar. Si es necesaria la utilización de una nueva pieza, es

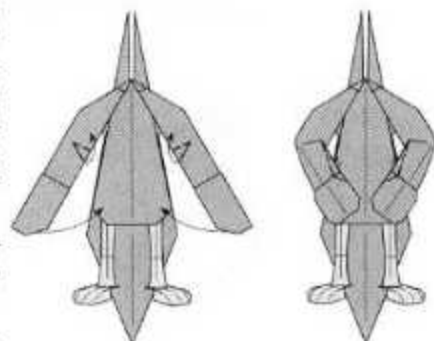

porque antes me he estrojado las neuronas y ha sido imposible compatibilizar colores o partes del modelo. Para comentar esta situación, expongo un ejemplo reciente.

En primer lugar dibujo el personaje con todo detalle.

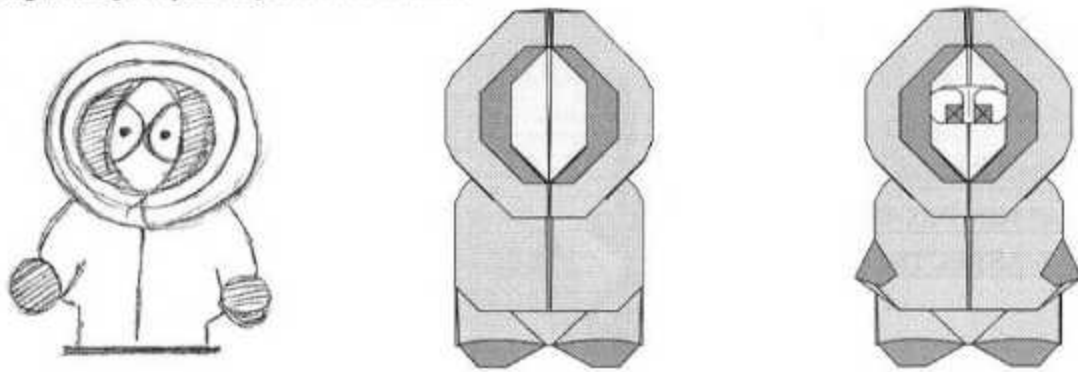

Realizar una versión simple del amigo Kenny de South Park es bastante sencillo y con cuatro piezas es más que suficiente. Puedo complicarlo un poquito más, añadiendo los brazos y las manos, sin crear pieza alguna. Si quiero ser más realista puedo dar un paso más y mediante la creación de una nueva pieza y la modificación de los colores en las iniciales, consigo el detalle del forro del abrigo en la cara.

III) ASPECTOS FINALES

Después de varios años creando cartoons nunca he dejado de leer papiroflexia, la lectura me sugiere nuevas bases para aplicar a algún modelo que tengo "aparcado" porque ese día no estaba inspirado.

Y hablando de inspiración, cuando algo no me sale, no me desespero. Lo que hago es dejarlo por unos días. Creo que el subconsciente debe seguir trabajando en ello porque pasado un tiempo, vuelvo a retomar el modelo con más ganas y me suelen ocurrir cosas sorprendentes: encuentro un camino nuevo, resuelvo el problema, aparece una nueva base que me sugiere un cartoon inédito...

Intento captar el alma de la figura, dejo a un lado aspectos que no le dan vida y que de alguna manera entorpecen mi labor creadora.

Tampoco me desanimo fácilmente ante las críticas, sobre todo las más feroces que suelen provenir de mi propia familia. Si bien, una buena crítica constructiva me ha ayudado a intentar superarme.

Hoy día, creo que sin pecar de inmodestia, me considero capaz de seguir "recreando" con técnicas papiroflécticas otros simpáticos cartoons, mientras soy consciente de que me falta dar el gran paso: Crear un personaje mío, con una personalidad propia, que estuviera a la altura de estas magníficas y universales creaciones con las que tanto estoy disfrutando y a cuyos creadores, rindo desde aquí mi más sincero homenaje de admiración y respeto.

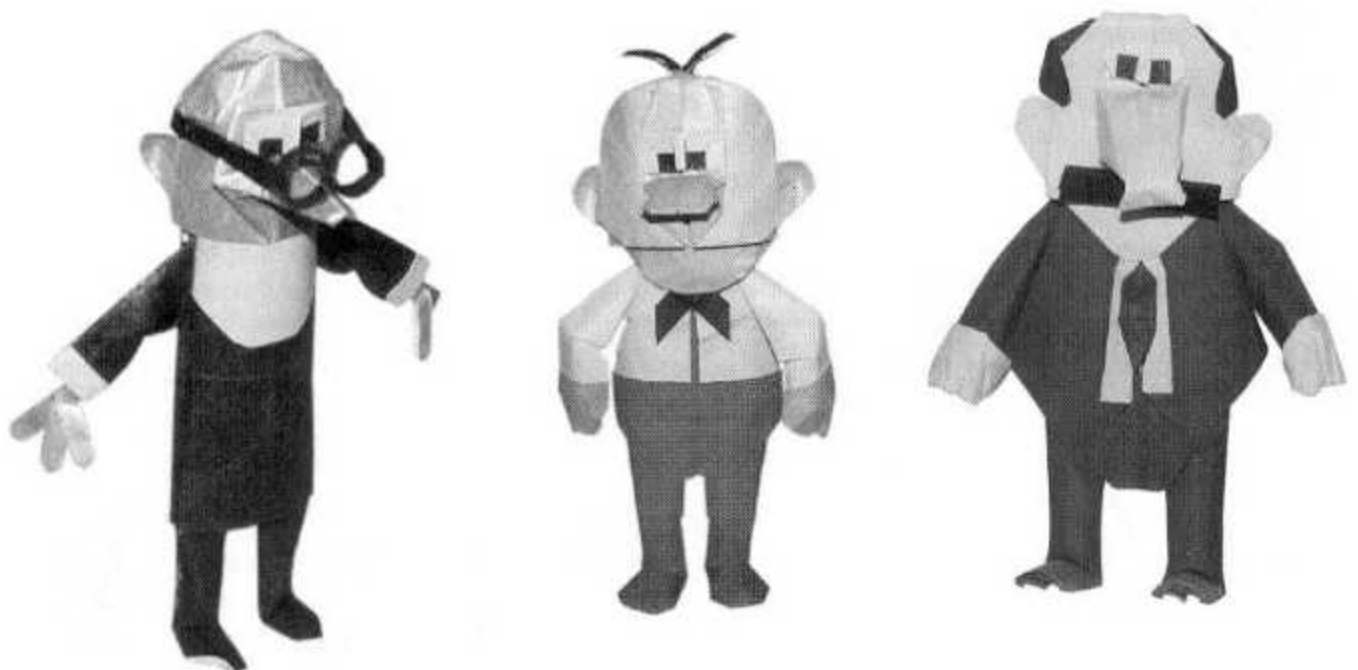

CREATING CARTOONS

By Halle

My sincere thanks to Alfredo Pérez Jiménez for his advice and assistance when I wrote this article and to Anibal Voyer for the illustrations.

- I) **INTRODUCTION**
- II) **CREATION PROCESS**
- III) **FINAL ASPECTS**



I) **INTRODUCTION**

Since my very first origami cartoon was born, a personal version of the Pink Panther, I have often been asked to explain how and what is my creation technique.

In this article, I'll reveal my "modus operandi", but it doesn't mean that I follow it word for word. Absolutely not, my motto is that if there's anything charming in the fascinating world of creation, the creator is at liberty not to follow any rule but be guided only by intuition and inspiration; only then I believe one can come to get his own style... at least that's what I try.

I consider "creating", except maybe for geniuses, a process that can't be acquired in one single day. Personally I think it's a question of time and that the desire of making up models comes from inside. It's hard to explain the feeling it produces, I only know it surrounds me, the time goes on and I don't notice it; and above all, I relax.

I spent much time folding other creator's models before this desire appeared and when it did, I kept wondering how I could start searching for something different instead of creating more classical models such as dinosaurs, insects, animals, etc.

By that I mean that I had already taken a big step: I mastered the traditional bases and on the other hand, as Juan Gimeno says, I had "read" a lot of origami, which consists of carefully examining the diagrams without even making a single fold, picturing the process and the construction of the model mentally.

But now I am going to be direct and get to the main part of this article.

II) **CREATION PROCESS**

In the creation process for new models, I follow the parameters below:



1) I determine the principle of what I want to create and draw a picture of the model giving emphasis to the main parts and every kind of detail that defines the personality or gives life to the drawing.

2) Once the model is drawn, I think about all the pieces I might need to build it. I associate them with the traditional bases and erase all the details that may be superficial.

3) Having determined the pieces, I begin to work with them, starting with the one I consider hardest, and that coincidentally is the one which defines the "soul" of the character.

4) While going on with the construction, I determine the relative sizes of the squares of paper, in a way that the parts' proportions are adequate.

5) Finally, I analyze the pieces and try to get them joined together.

To make the initial drawing, I use the technique of drawing circles and ellipses; I create a small draft, for example of the lovely Tweety.



This design technique is very simple and has many possibilities.



Afterwards, I refine the initial drawing with more details until it becomes clear what I want to create.

The most important part of the model is usually the face. Getting an expression which transmits sweetness, kindness, which makes one laugh... I



consider this very important.

While creating it may happen that the combination of pieces, colors or proportions suggests more than one character. As an example there are the faces of the bulging Homer Simpson and a first draft to the enigmatic Kenny.

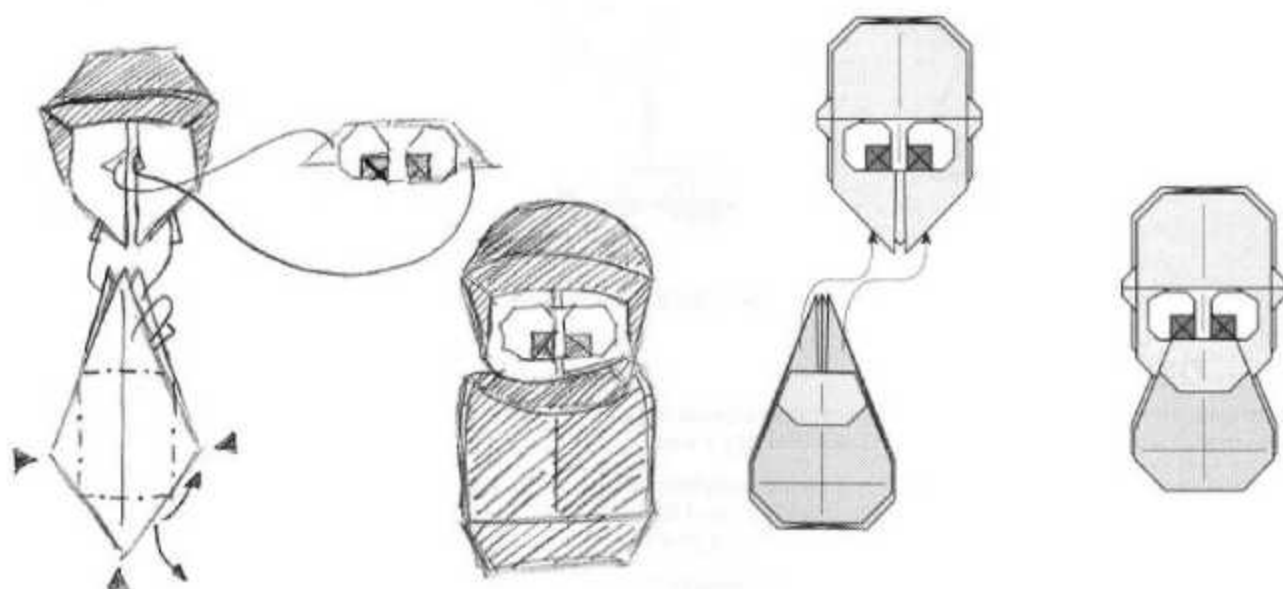

They are actually identical pieces, one preliminary and one bird base joined in the same way but with the color combination and different proportions I get very distinctive results.

The head normally has two ears, two eyes, the base for the face... this means too many points are needed to make it with just one single simple base. I must "sacrifice" some parts of the head to make them from another square... It's a question of imagination, inspiration and luck...

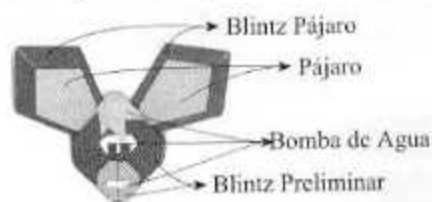

Sometimes I fold the traditional bases and play with them as in a puzzle. The simple act of arranging them gives me a good result as in the face of this little rat, which is created with a mix of almost all the simple bases (preliminary, water bomb, bird)

With that, I want to make clear that what I always try to do is to let myself be taken by intuition and by whatever my imagination tells me, with no restriction.



For the body, my favorite base is the Bird Blintz because it leaves a slit running down the piece so I get extra help to make future joins especially with the edges.

Using this base often allows me to get a color change.

I must pay much attention to the model and depending on how it is composed, it's easy to make it more robust or styled:

Giving bulk to the model sometimes is easy and other times harder. The simple arrangement of vertical and horizontal levels in the space helps a lot. Forming the joints gives it better realism.

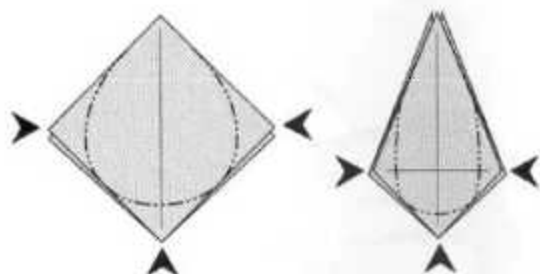

I came to the conclusion that, usually it's better to simulate certain parts of the body than trying to create pieces for it. For example, the fingers, on certain occasions look better with a light fold than if I try to create them one by one. To do this fold I use small tweezers for helping, this advice was given to me by my friend Anibal Voyer.

By the use of distinct pieces I get the additional advantage of being able to give more colors to my creations, which gives me an eye-catching and cheerful model.

But it's not about going to extremes. If it's necessary I will use a new piece when I've racked my brain and it has been impossible to make compatible colors or parts of the model.

To explain this situation, I use a recent example:

First I draw the character with all the details.

Making a plain version of Kenny from South Park is very simple and four pieces are more than enough. I simply use preliminary bases. I can make it a little bit more complex adding the hands, without needing any other pieces.

If I want to be more realistic, I can add one more step and by creating two new

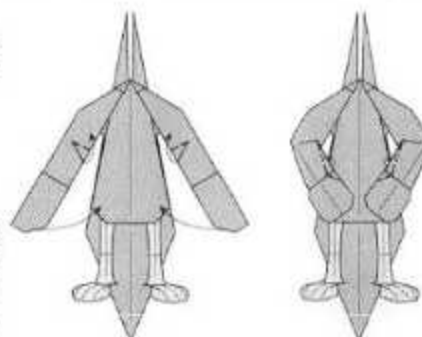



pieces and changing colors in the first ones, I obtain the eyes getting more expression and the detail of the hood over the head.

III) FINAL ASPECTS

After several years creating cartoons I've never stopped reading origami books. Reading suggests methods to apply to some model which I hadn't finished because that day I wasn't inspired.

And talking about inspiration, when I can't create something I don't get desperate. What I do is to leave it for some days. I believe that the subconscious may keep working on it because, after some time, I return to the model with gusto and surprising things happen: I find a new way, I solve a problem; a new base appears suggesting to me a new cartoon...

I try to catch the soul of the model; I leave out the aspects that don't give it life and in some way slow down my creating work.

I don't allow myself to lose the will to create because of the critics, especially the worst ones that may even come from my own family. On the other hand, a good constructive criticism has helped me to try to do better.

Nowadays, I believe, without modesty, I am capable of continuing to 'recreate' with origami techniques other lovely cartoons, being conscious that I haven't reached the most important level of creation: create my own characters with their own personalities that I hope may be as good as these magnificent and universal creations whose creators I sincerely admire and respect.



Artículo traducido por:
Thiago Alexandre Dos Santos

¡¡¡Hasta siempre, amigos...
y no olviden superpapirozarse
y cartoonorigamizarse!!!

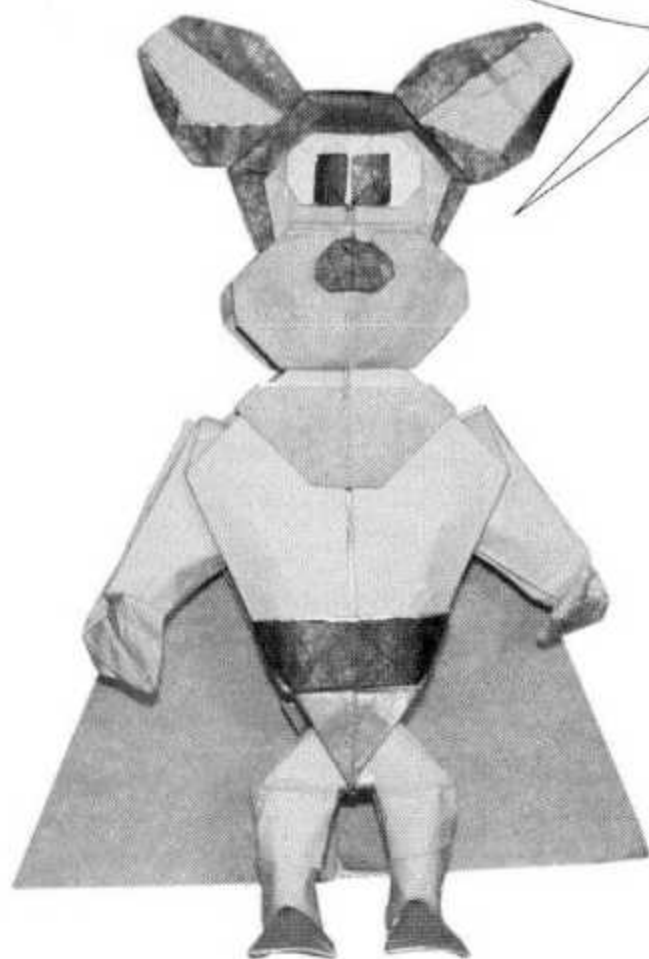

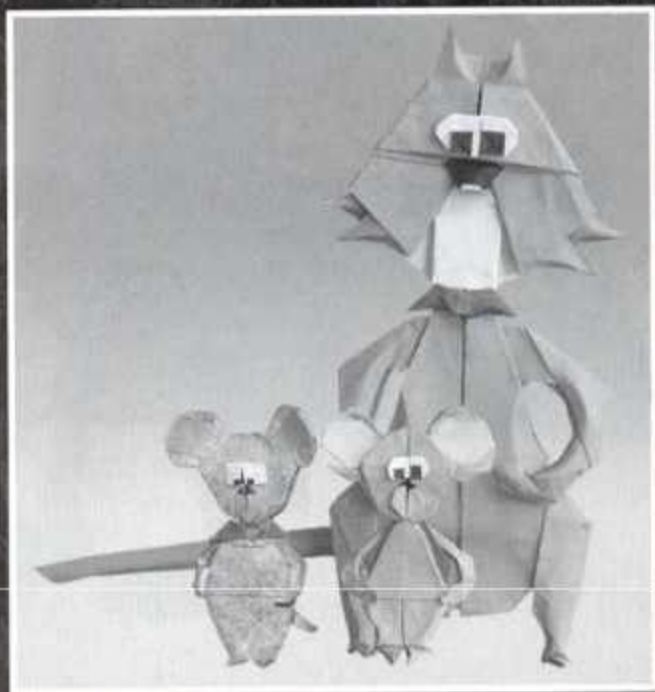
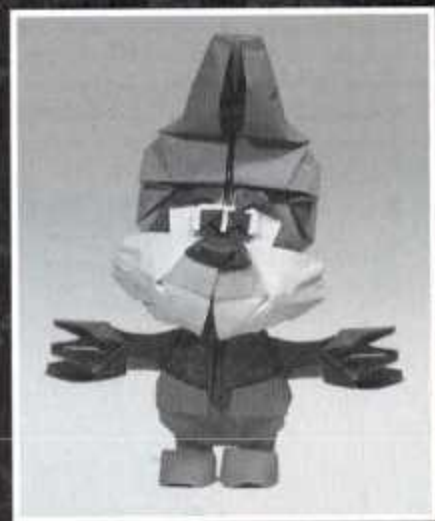
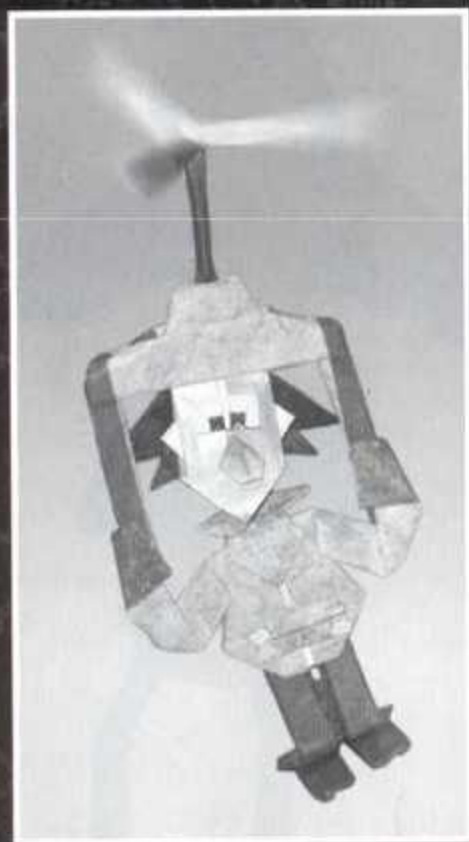
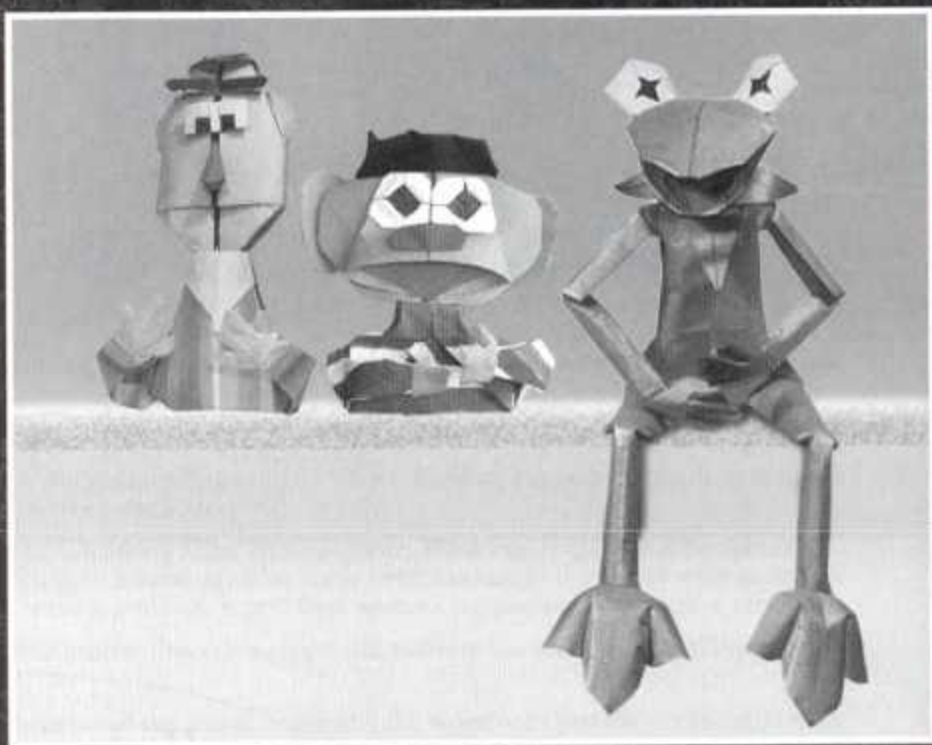

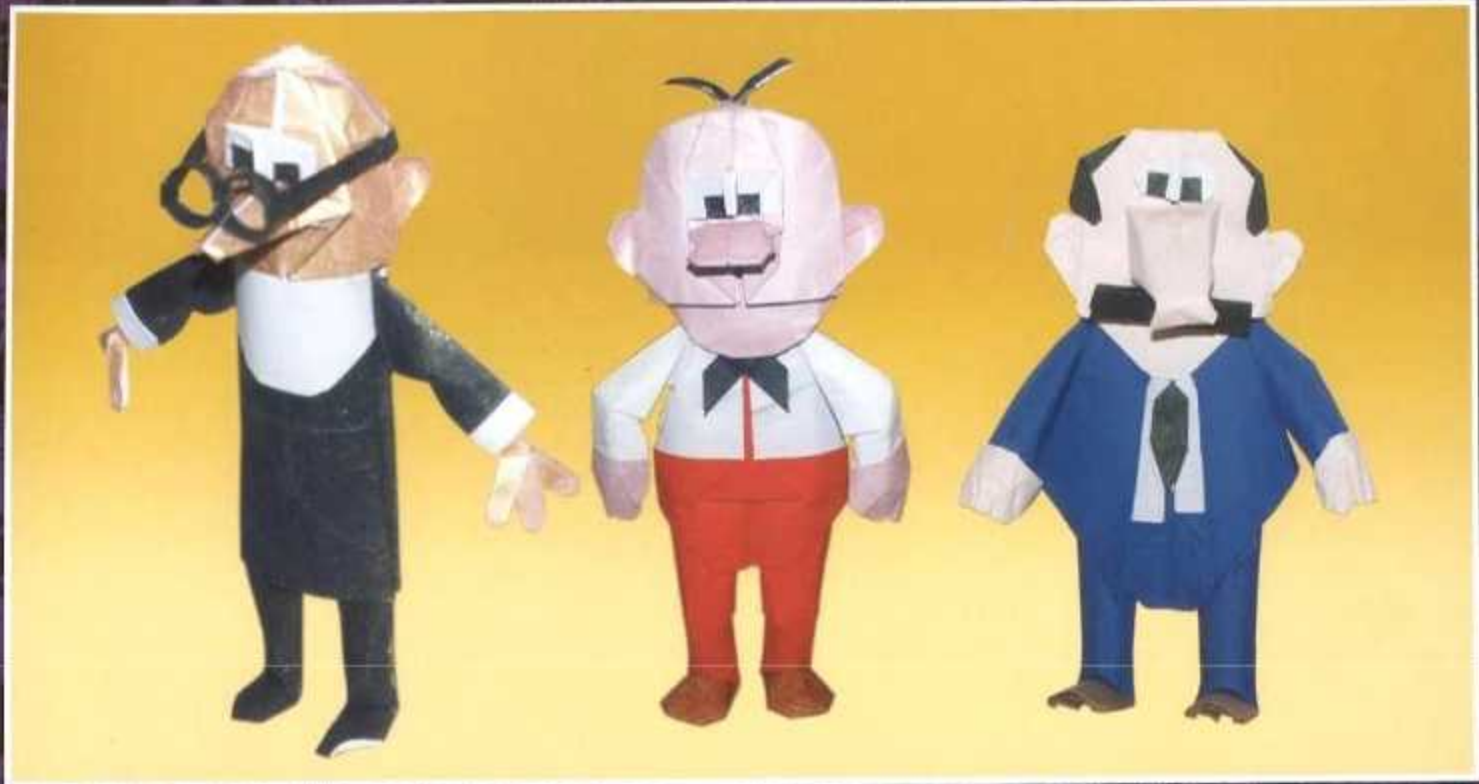



CarToon Origami 3