

#Vol 1

# 花间集

主题折纸



国产原创折纸

# 序言

这本书的出现始于一个契机，有一天波波奶茶问大家有没有兴趣合起来出一本国人自己的折纸书，突的风起云涌，乌云变换，龙凤呈翔，本书在一片华光中应运而生。可是选什么题材好呢？在吸取了过往折纸活动成功与失败经验后，波波大人决定将今年喷涌而出的蝴蝶做为主题，收天下壮士之蝶，行折纸强咕之义。

本书收纳有系统、陈晓、Syn、王兆健、子良、活宝小骆、eR、开明、孟伟凝、港欧一家、St、陈树、孤雏、空想、逍遥丸子、Matsut4ke、嗑盐汪、林伊桐、桑Q、XR、渔鱼余、五迷、子游君、Tosummerny等24位折纸设计师的作品，其中多名成员，在国内外享有盛誉。

相信爱折纸的你总是问，国人自己的蝴蝶书在哪？既然你诚心诚意的询问，那编者大发慈悲的告诉你，就是今天！《花间集》以折纸圈火热的设计题材为主题，收集国内著名设计师的设计编纂成集。作为这个系列的第一本书，希望能收获广大折纸爱好者的喜爱，吸引更多的人加入折纸的大家庭，将中国折纸圈做大做强，最后本书也成为大家心中最好的折纸书。

徐涛

2022年5月2日

# 设计者介绍

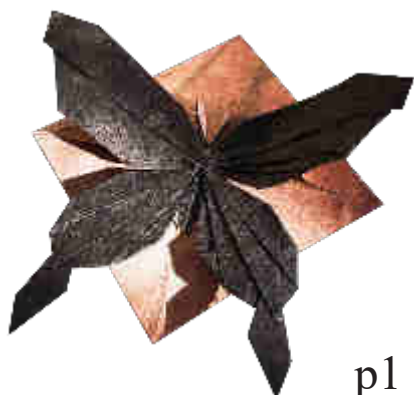

p1

**李嘉辉 (Syn)**，一名内蒙的年轻人，现坚守在银行出纳员的岗位上。在他幼儿园时期就展现了无与伦比的折纸天赋，到了如今三十而立的年纪，他已经把小品折纸彻底玩明白了。

2020-2022年乌镇折纸云聚讲师  
折纸刊物《脑洞∞》主编  
第二届国际折纸马拉松讲师  
2021年出版个人作品集《Comic Origami》

bilibili: Origami\_Syn

**徐涛 (逍遥丸子)**，syn的微信好友。自2014年开始折纸，喜欢设计，染色和绘制折图，曾在高中获得嘉兴市“新视野杯”中学生语文阅读竞赛二等奖。最喜欢看《名侦探柯南》，但是一千集以后TV组水的让他很难受。

2020年乌镇折纸云聚讲师  
折纸设计入选《OrigamiUSA Origami Collection》、  
《Páginas de origami》  
2021年绘制Syn个人作品集《Comic Origami》

bilibili: 波波奶茶的快乐屋

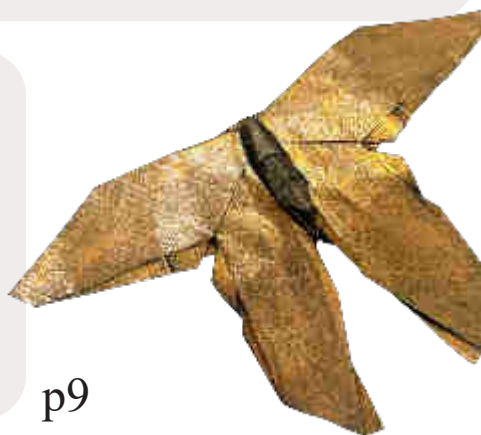

p9



p15

**天书**，一名普通的金融工作者，探索折纸十年之久，擅长飞鸟鱼虫花卉走兽的灵魂注入式整形。曾是百度折纸吧吧主，获得百度手工大赛冠军，连续两届国际折纸网络奥林匹克比赛亚军，作品在上海群众艺术馆、新国际博览中心、浦东图书馆均办过展览，也得到过多位海外折纸家的肯定。

各类平台id: tosummerny

**空想**，一位总是上流但是一点也不下流的折纸爱好者，纸圈弦师，折纸怪人王。初中开始接触现代折纸直到现在毕业工作已经快10年了然而进步是肉眼可见的小，目标是设计前期打线步骤较少的作品。

2020-2022乌镇线上云聚折纸讲师  
浙江人民美术出版社签约纸艺作家  
2021川渝面基大会线上讲师  
折纸设计《Silver-Throated Long-Tailed Tit》入选  
《OrigamiUSA Origami Collection 2021》

小红书: 1044457884  
bilibili: 空想0o0



p21

**郭嵩（五迷）**，非五月天歌迷（我起这个网名的时候，那几个人还没出道呢），前推理小说作家（生涯停留在写完第一篇长篇小说的路上，至今仍在收集资料中），前某蓝电视台电视短剧编剧（至今未收到稿费，疑似被介绍人截留），幼儿园开始接触折纸，小学二年级，依靠给同学折青蛙，赚到了人生第一桶金（30页散装图画纸），中断25年后重新开始折纸生涯，至今仍在折纸设计创作黄金期。

折纸合集《一水一世界》主编（第一本正式出版的国内高等级折纸书）

电子年刊《贺岁折纸》发起人，主编

个人作品集《Duo-color Origami/双色折纸》

个人主页：[www.facebook.com/mi.wu.311](http://www.facebook.com/mi.wu.311)

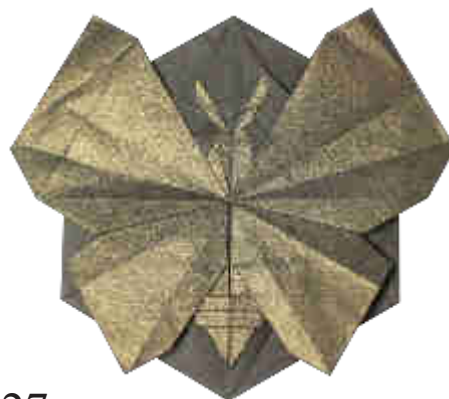

p27



p33

**Matsut4ke**，咸鱼折纸人。因为太咸鱼了所以没有个人简介。

**开明**，非理性折纸狂热者、推特常住人口、泡面品鉴爱好者。目前是一名大学生，喜欢骑黑色小电动通勤，有很多男同学喜欢和我玩。2016年初闯折纸圈，爱折动物和幻兽，是一名非理性折纸人（Albert Ellis《理性情绪》：“在自己擅长的领域投入过多的精力，忽略生活的其他方面”）。希望新的一年身体健康，甚至身体强健。

2016年 在国际版贴吧奥赛中取得5金2银

2019年 进入强咕群

推特账号：HS1espRFENGk6Yo

贴吧账号：涂涂开明

小红书：涂开明

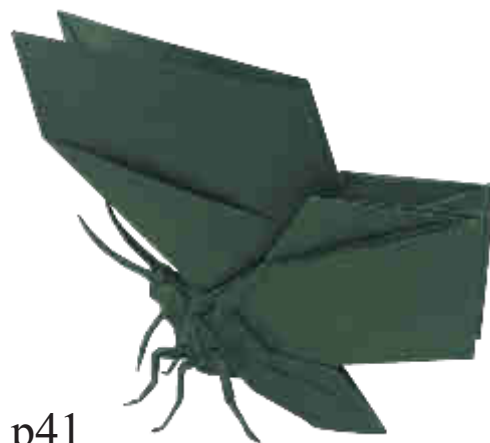

p41

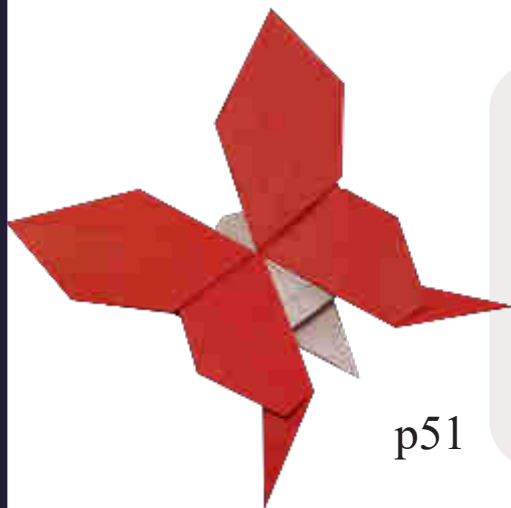

p51

**张义帆（港欧一家）**，网名折纸小呆，曾用名e小呆e，黑折城创始人，擅长22.5°乱射。从出生以来到现在哭的最后一次是手游《折纸英雄》腹死胎中了，平时是一个坚毅的男子汉。

小学折纸课代表

黑折城创始人

拈花折纸一笑堂门徒

2014年-2020年折纸吧吧主

折纸活动公益人

bilibili：张长长-Origami

微信公众号：折纸圈





p55

桑Q，折纸启蒙于幼年时期母亲教的一个千纸鹤。高中时借了前桌女同学的折纸书后眼界大开，糟蹋了不少作业本纸后甚至斗胆尝试了设计，本作蝴蝶就脱胎于大约92年的某次乱捏。2013年拜读叹为观止发布的现代折纸系列科普文后再次入坑。在纸圈晃荡几年后创办【折纸日常】公众号用于督促自己坚持折纸这个爱好，佛系更新至今。

微信公众号：折纸日常

孟伟凝，网名212moving。拈花折纸一笑堂门徒，百度折纸吧小吧主，2020、2021乌镇线上云聚折纸讲师，第一、第二届国际折纸马拉松讲师，《一水一世界》作者之一，2020年出版个人折纸作品集《Origami Moments》。

bilibili: 212moving



p61



p65

St，普通的高中生一枚，14年入坑，可惜活动范围有限，19年开始创作的，路虽然不是很好走，还是一路摸鱼摸过来，现基本上可以较熟地运用225进行设计，追求复刻，也追求所设计的作品可以涉及多方面生物。

bilibili: Surprise-t

渔鱼余，非著名折纸人，折龄10年纯萌新。曾立志要成为一名悬壶济世的名医，但没考上，遂转兽医。

p81



**嗑盐汪**，现代折纸爱好者，为了支撑折纸理想，找了一份每周7×24小时的兼职，却依然徘徊在折纸圈边缘，有过一些简单双色萌物和平面双色设计。

2020-2022年乌镇折纸云聚讲师  
「脑洞」杂志编委划水成员  
「折纸日常」专栏「萌混日常」鸽子小编

bilibili: 嗑盐汪



p87



p91

**孤雏**，一名来自2014年的现代折纸爱好者。17年暂时退坑，2020年回归折纸于9月份开始设计作品，喜欢22.5度乱射。

2021年3月份在微信公众号折叠之间开设折纸教室《鲲》  
2021年7月份在微信公众号川渝折纸发布设计作品《小白船》

bilibili: 咕笑

**林伊桐**，性别男，为了方便，小伙伴称呼一桶、一同、一筒的都有。19年开始尝试折纸设计，现为能和一帮大佬一起玩折纸感到窃喜。

百度折纸吧游客  
ioio多届未参赛人员  
作品卖不出天价小伙  
吉尼斯折纸记录无记录保持者



p97



p111

**eR**，延毕边缘横跳的二刺螈折纸选手，蛇腹界蝉联卵王，主动技能为消耗爱力提升大额折力值，但成长属性很低，后期输出跟不上版本，不建议投入资源培养。毕生梦想是提升折力至破碎虚空回到6年前阻止自己开始折纸，至今仍在为此不懈奋斗中。

bilibili: EreRe\_



p123

子游君，与君子游，如入芝兰之室，久而不闻其香，则与之化矣；与小人游，如入鲍鱼之肆，久而不闻其臭，亦与之化矣。

第九届国际折纸奥林匹克设计师兼评委之一

bilibili: 与君子游

XR，生命科学专业大学生，折纸练习生。喜欢折纸挺多年，但由于愚笨与懒惰，折纸进步缓慢。出于对大自然生命的热爱，梦想设计出各种神奇的动植物，对古生物和幻想生物也很有兴趣。正在努力学习中...



p135



p147

陈晓 (Ob)，国际顶尖折纸设计师，擅长多种题材创作。首个Eric Joisel Award国际折纸大奖获得者，作品曾在日本、法国、英国、意大利和国内各地展出，多次受邀作为国际折纸大会特别嘉宾。代表作品集《Amazing Origami》，畅销国内外。

bilibili: 某一个晓

骆昱超 (活宝小骆)。折纸爱好者、设计者，百度折纸吧小吧主。2014年开始原创纸飞机，2016年正式接触现代折纸艺术，仿折各种作品的同时尝试折纸设计、总结经验。喜欢设计生活类、玩具类和平面类作品，尽量利用折纸结构来实现设计的整体比例架构，思路独特。目前从事通信行业，偶有折纸，划水摸鱼中，发誓永不退坑！

获得了2017届国际折纸互联网奥林匹克 (IOIO) 设计类项目第一名

facebook用户名: 骆昱超  
推特twitter ID: Mike\_Luo\_  
bilibili: 活宝小骆



p151

**系统**，国内顶尖涩涂品鉴师，能鸽善鹉的不知名折纸人。喜欢折制与人类雌性个体相关的作品。许多年前在群里与syn先生的一次激情互喷刺激了我，并促使我为了打脸syn通宵设计+折制了至今我一直无法还原的作品“赫萝与狼”，从此便从syn冷嘲热讽的对象一跃成为心肝宝贝，开始了与各个群友的各种不正当关系。人生目标是有一天自己的作品图被度娘屏蔽。

b站UID:454834200

p155

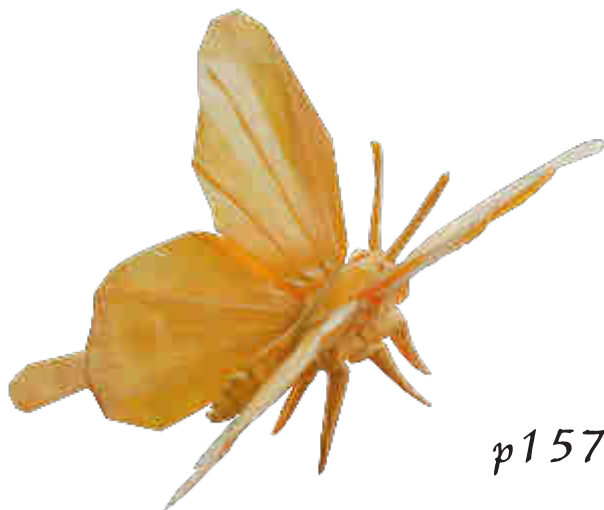

p157

**王兆健(Tony)**，Tony老师虽然不会理发，但是折纸，摄影，吉他，音乐创作，蝶艺都会哦。。。

经典畅销折纸书《最折纸-折纸新世代》译者  
折纸教室讲师  
乌镇云聚讲师  
折纸代表作棒棒糖，畅销海内外

小红书: 678197117

**子良** 大学二年级非冷静折纸练习生、滑板摔跤手。自2015年迷上折纸，喜欢动物和昆虫为折纸题材。新年的折纸目标是每月能有一个新设计。

2015年折纸时眼皮夹中一只蚊子  
2021年进入强咕群

推特: ziliang5386  
小红书: 6367236823

p161



p163

**陈树**，职业养猪爱好者，动物营养师助理，稍微会点设计善于潜水、失联、爽约、当鸽子，兼任键盘侠。善于靠折纸圈钱，以靠折纸发财致富为毕生目标。偶尔瞎研究一下非45度蛇腹，非225角度的双色设计，没啥理论知识，全靠瞎折。

b站UID:184378291



# 符号和基本技法

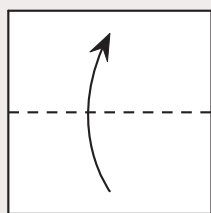

Valley-fold  
谷折



Mountain-fold  
峰折

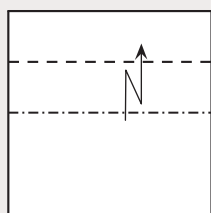

Pleat-fold  
段折

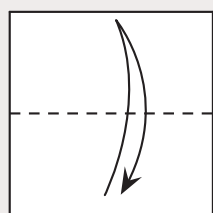

Fold and unfold  
段折

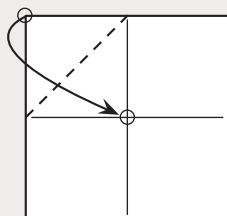

Fold so that the two circled points  
will be on top of each other  
点对点折叠

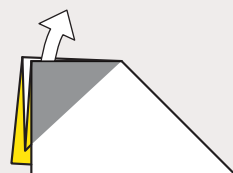
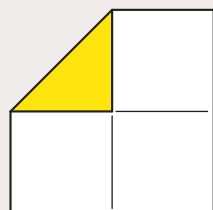

Pull out the hidden layer.  
引出内部纸层

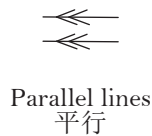
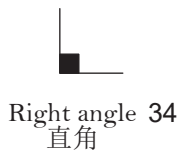
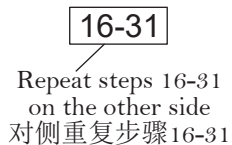
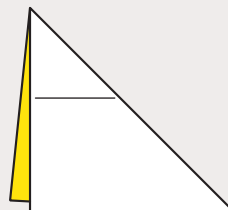

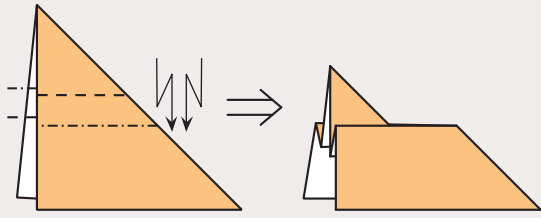

Inside crimp  
向内双向段折

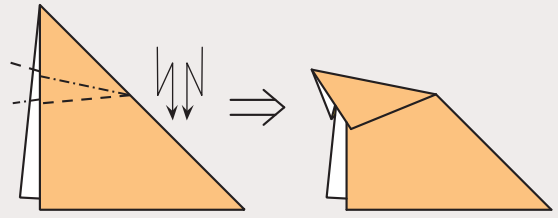

Outside crimp  
向外双向段折

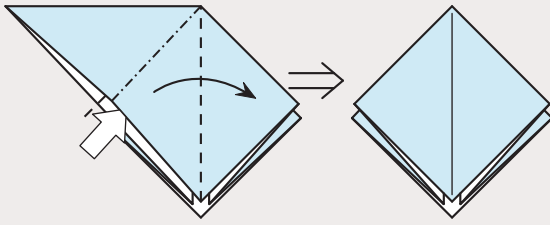

Squash-fold  
打开压平

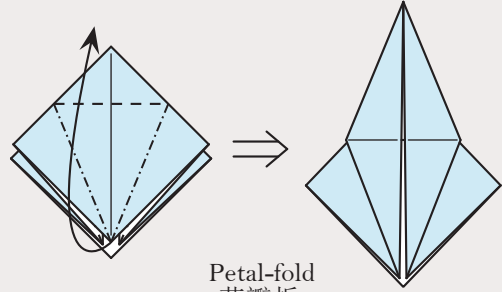

Petal-fold  
花瓣折

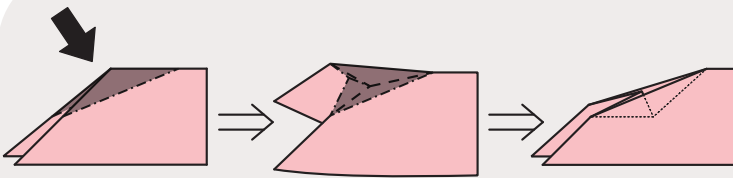

Open sink  
开放沉折

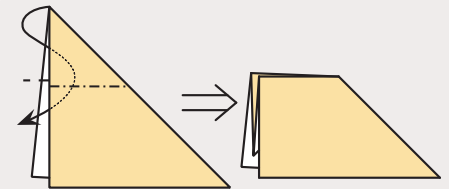

Inside reverse-fold  
内翻折

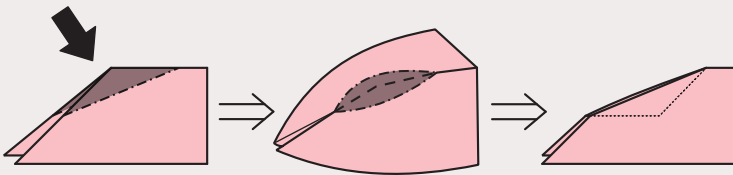

Closed sink  
闭合沉折

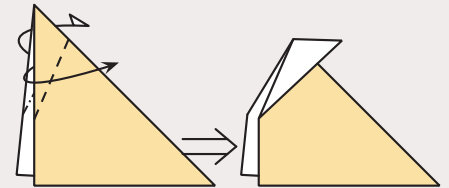

Outside reverse-fold  
外向翻折

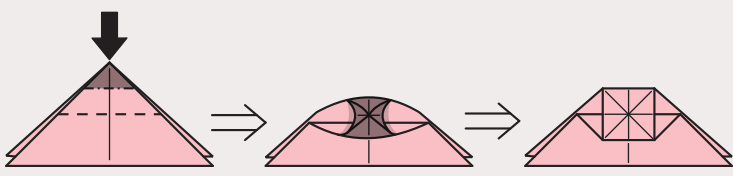

Spread sink  
延展沉折

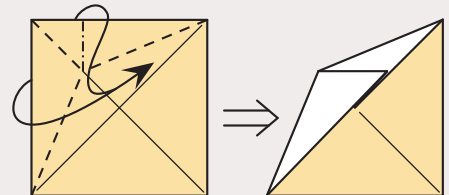

Rabbit-ear fold  
兔耳折







破  
茧

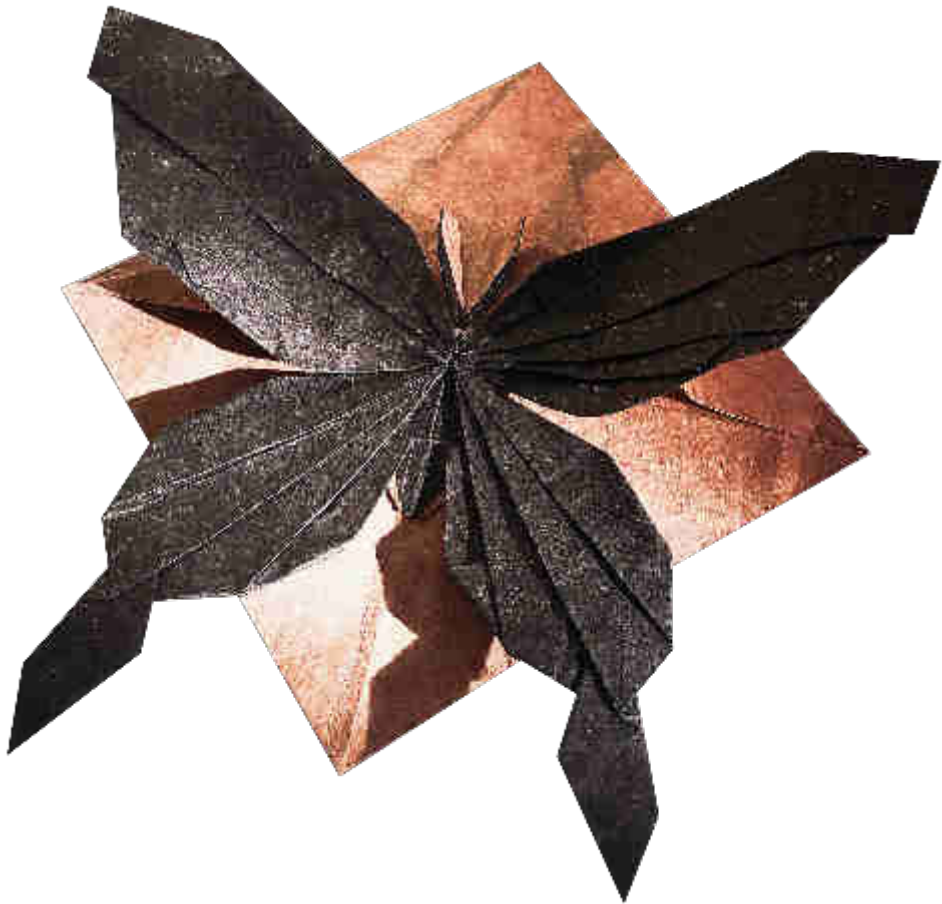

# 破茧

设计/Designer: 李嘉辉 (Syn)  
 图示/Diagramer: 徐涛 (逍遥丸子)

推荐用纸/Paper :  
 - 教育折纸 24×24 cm  
 - 三明治 23x23 cm

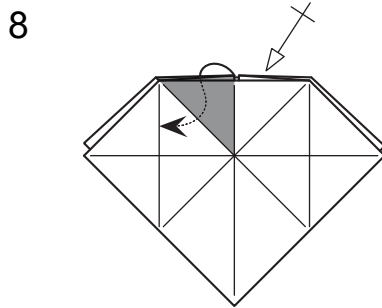
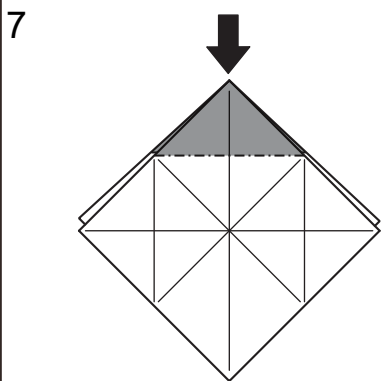
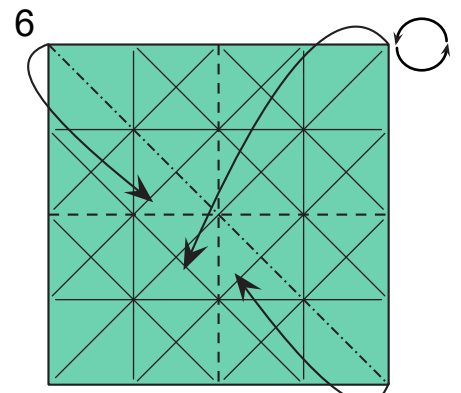
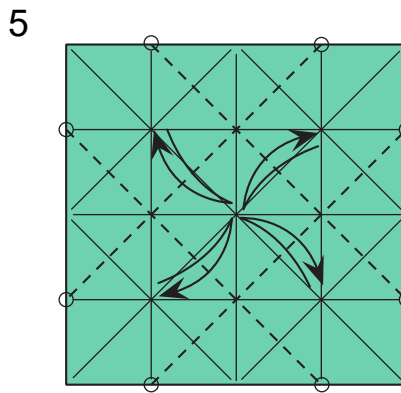
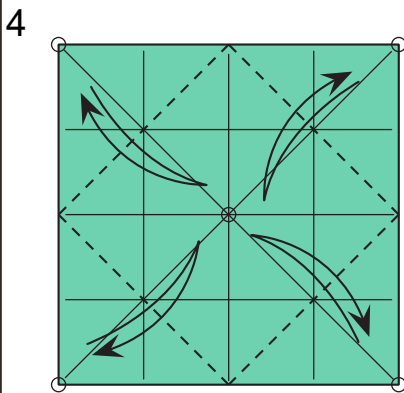
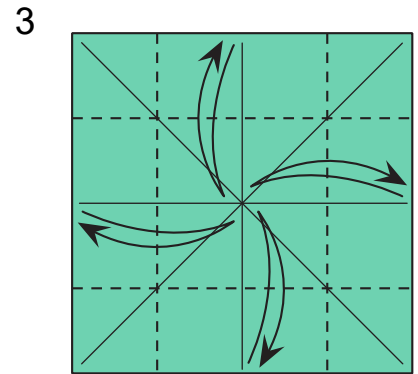
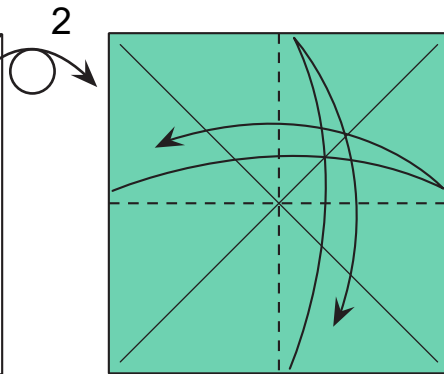
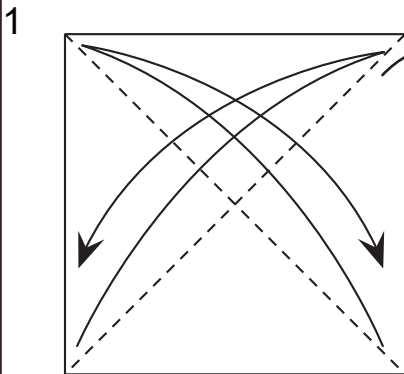
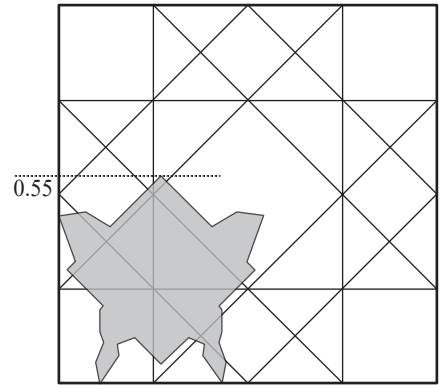
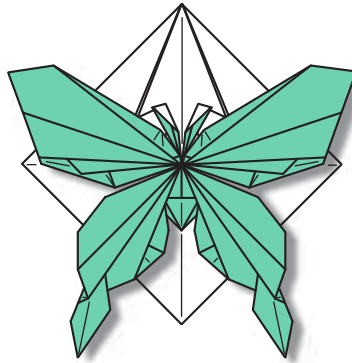

Fold in the shadow.  
 阴影处内翻折

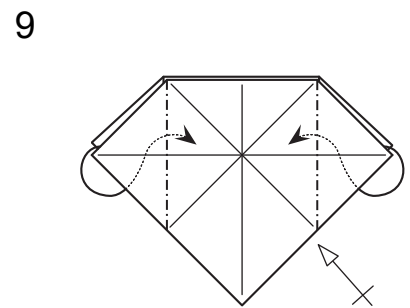

Inside reverse-folds.  
 两边内翻折

10

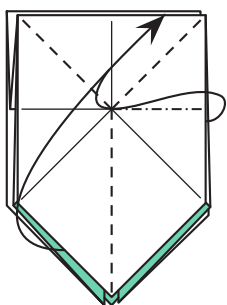

11

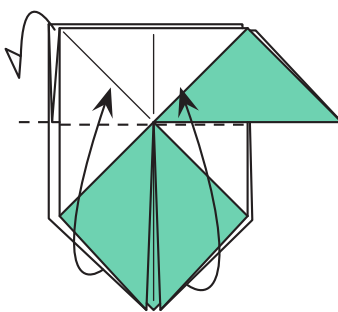

Adjust the layers.  
调整纸层

12

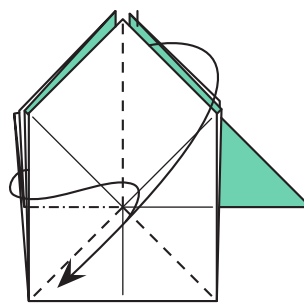

13

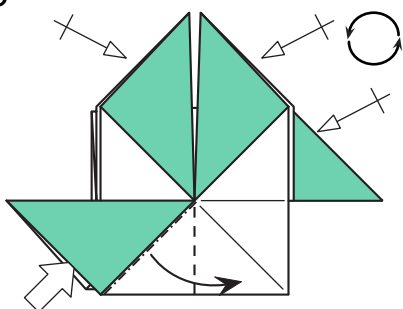

Open and flatten.  
撑开压平

14

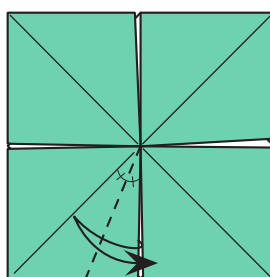

15

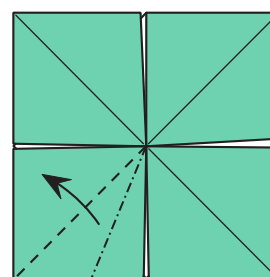

Open and flatten.  
撑开压平

16

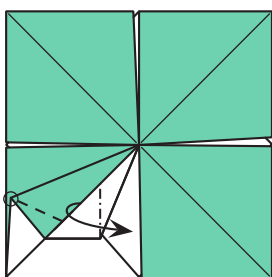

Swivel fold.  
旋转折压平

17

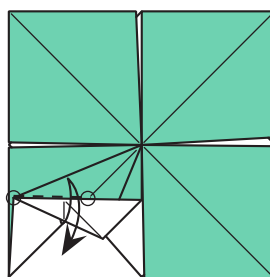

18

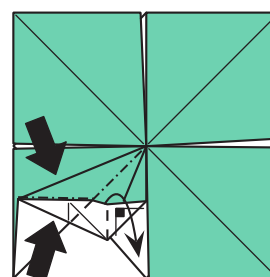

Complex rabbit-ear fold.  
从上下挤压，右侧打开压平

19

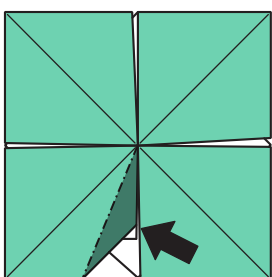

Sink.  
沉折

20

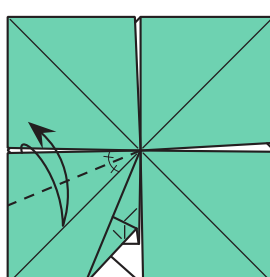

21

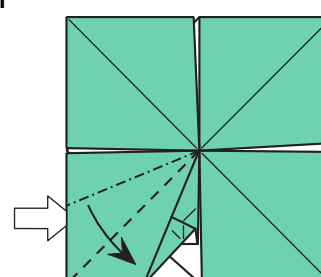

Open and flatten.  
撑开压平

22

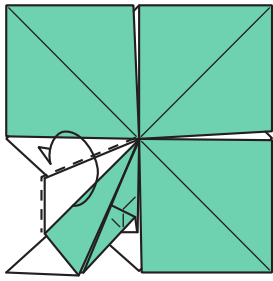

Unwrap to color change.  
翻双色

23

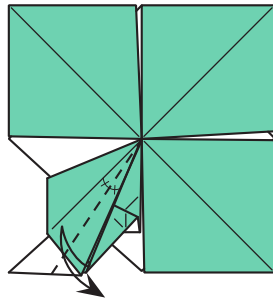

24

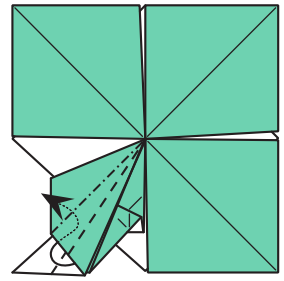

Swivel and flatten.  
向内旋转段折压平

25

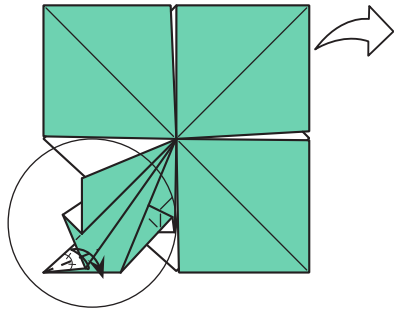

Zoom in.  
视图局部放大

26

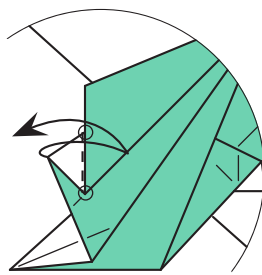

27

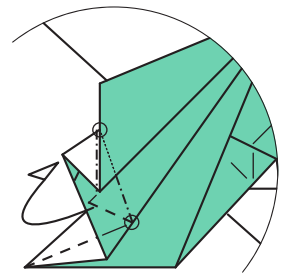

Swivel and flatten.  
向内旋转折压平

28

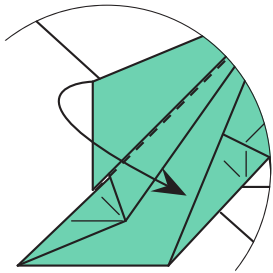

29

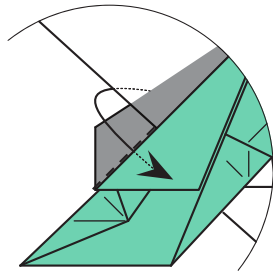

Insert the corner.  
塞进内部

30

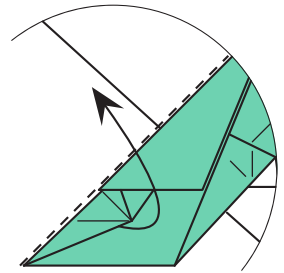

31

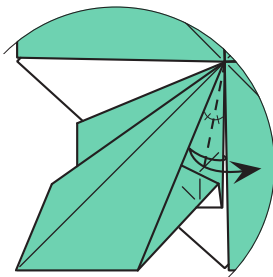

32

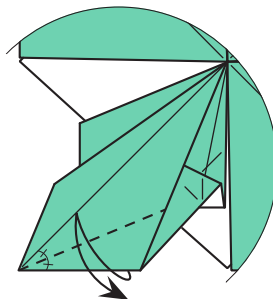

33

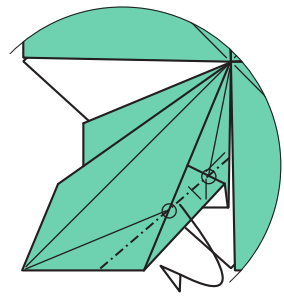



34

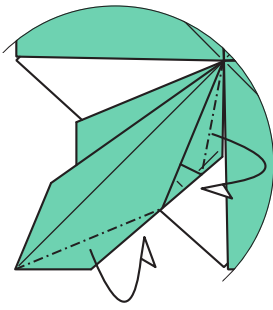

35

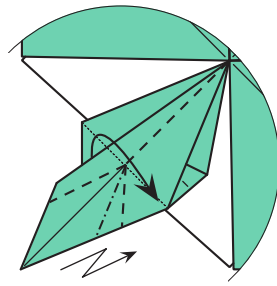

Collapse.  
按峰谷聚合

36

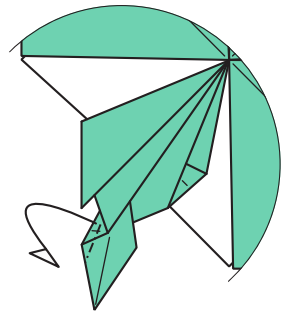

37

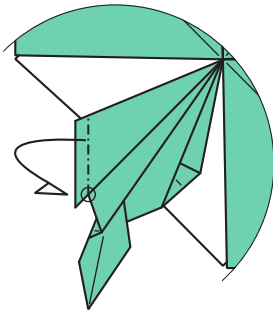

38

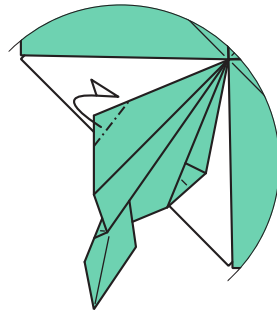

39

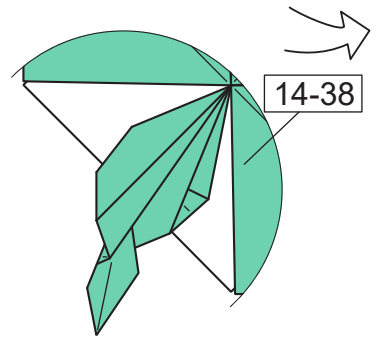

Repeat steps 14-38  
on the other side.  
对侧重复步骤14-38

40

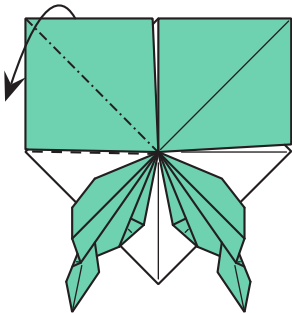

41

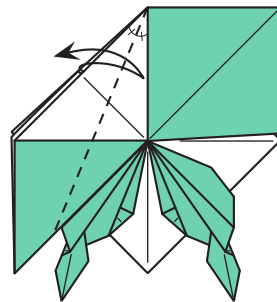

42

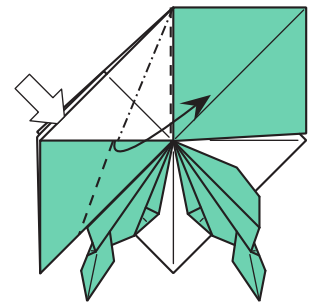

43

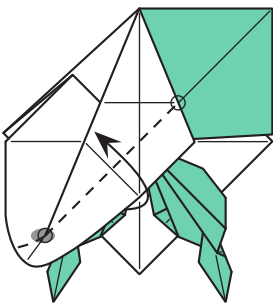

44

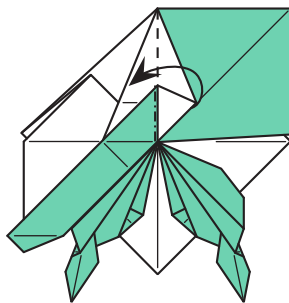

45

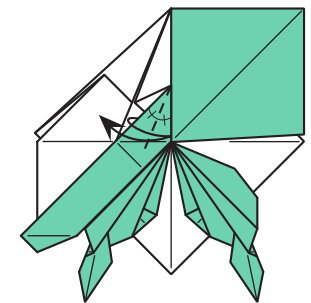

46

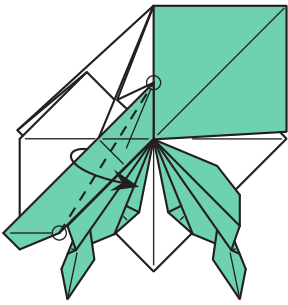

47

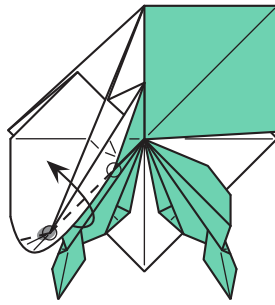

48

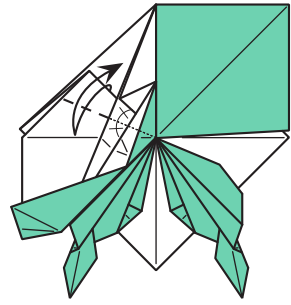

49

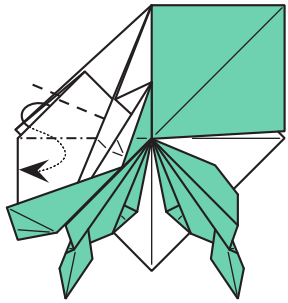

Swivel and flatten.  
向内旋转段折压平

50

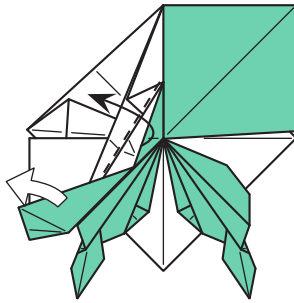

Unfold.  
展开

51

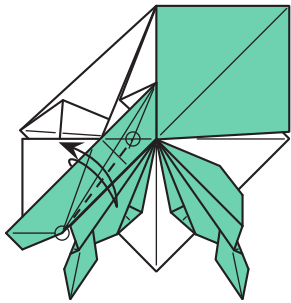

52

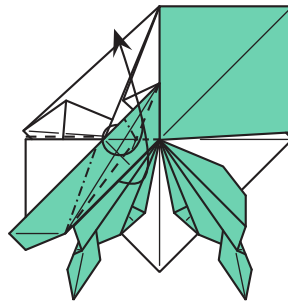

Collapse.  
按峰谷聚合

53

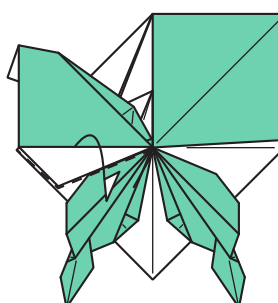

Unwrap to color change.  
翻双色

54

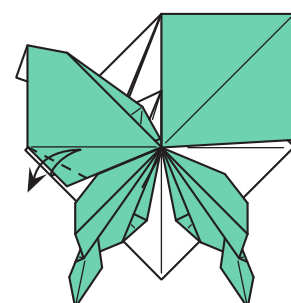

55

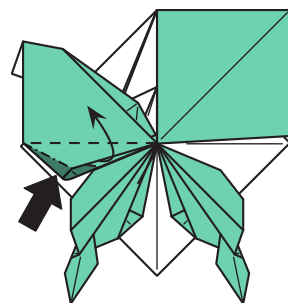

Spread sink.  
延展沉折

56

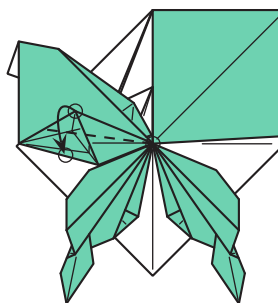

57

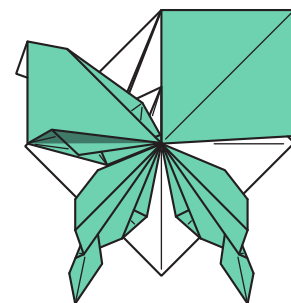

Tuck the shaded area inside.  
将阴影调整至内部

58

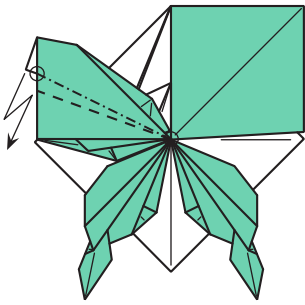

Pleat-folds.  
段折

59

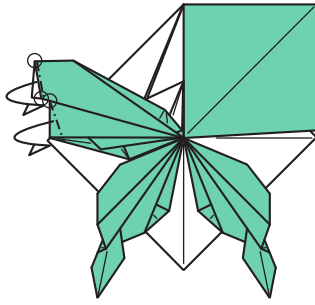

60

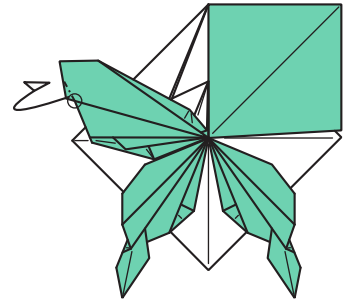

61

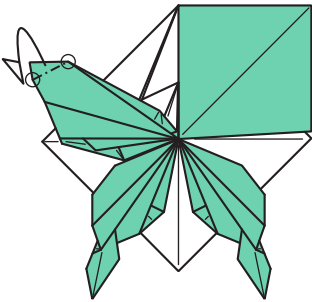

62

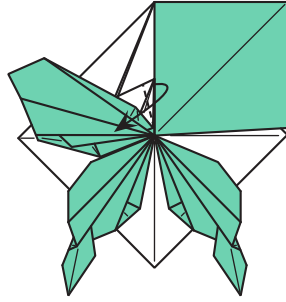

63

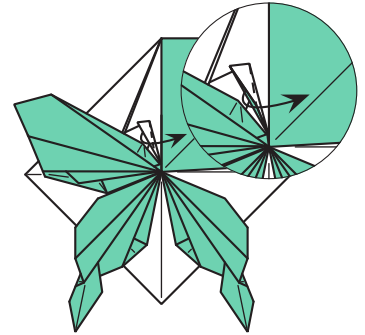

Swivel fold.  
旋转折压平

64

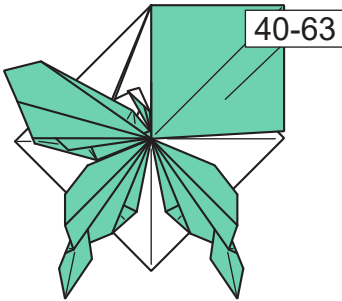

Repeat steps 40-63  
on the other side.  
对侧重复步骤40-63

65

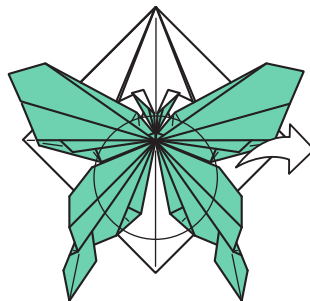

Zoom in.  
视图局部放大

66

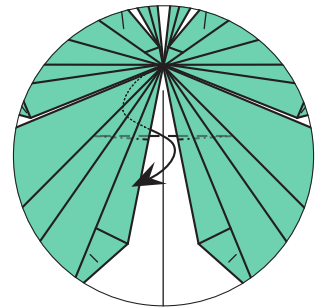

Inside reverse-folds.  
内翻折

67

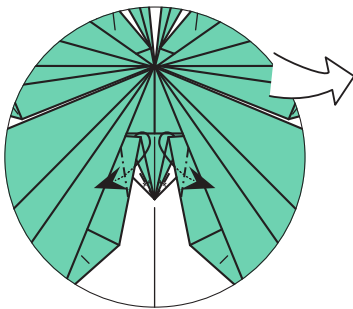

Inside reverse-folds.  
两边内翻折

68

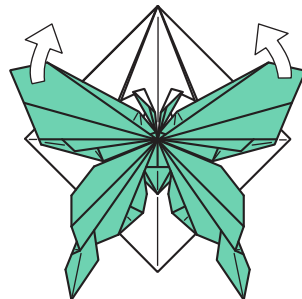

3D Shape the model.  
立体整形

69

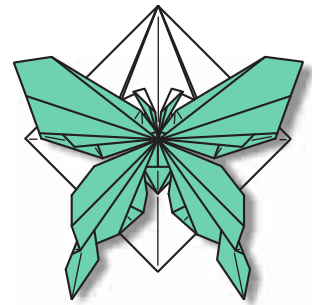

Complete!  
完成!





黄色闪光



# 黄色闪光

设计/Designer: 徐涛 (逍遥丸子)  
 图示/Diagramer: 徐涛 (逍遥丸子)

推荐用纸/Paper :  
 - 和纸 20x20 cm  
 - 绵箔纸 20x20 cm

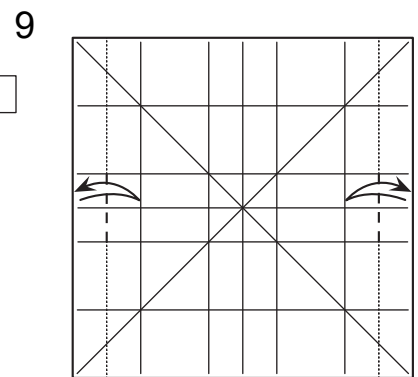
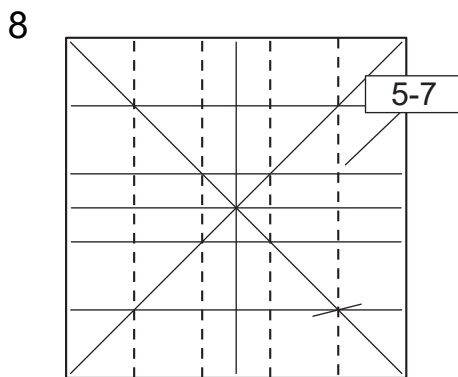
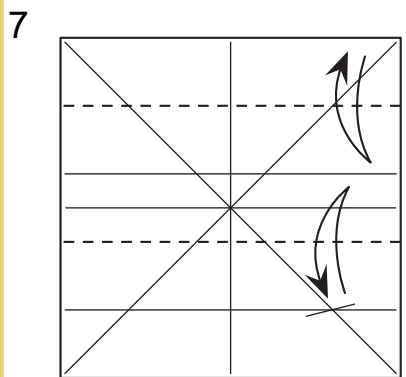
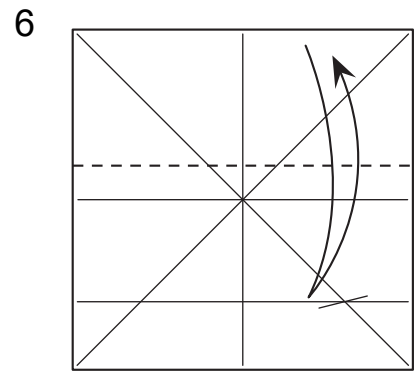
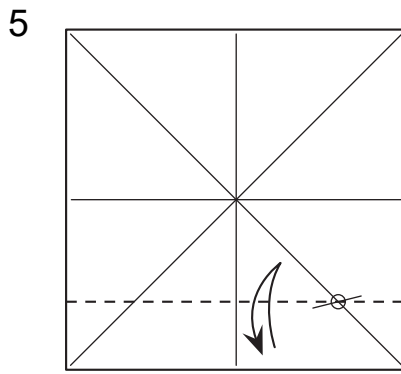
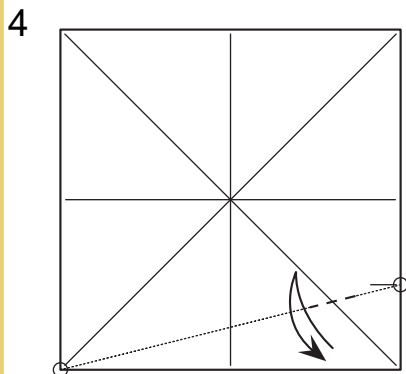
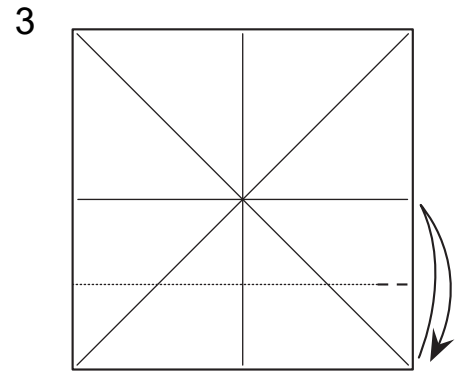
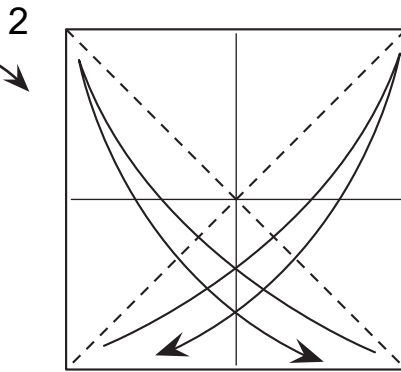
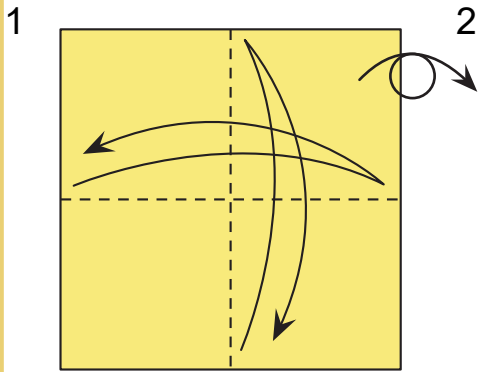
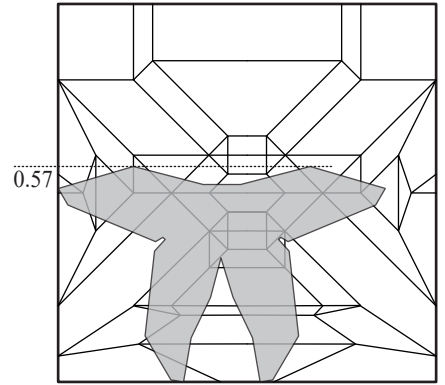
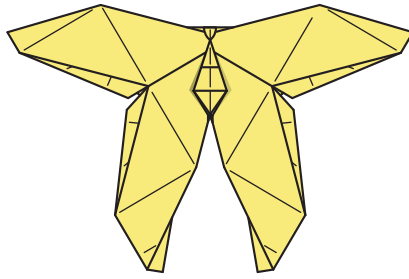

重复步骤5-7

10

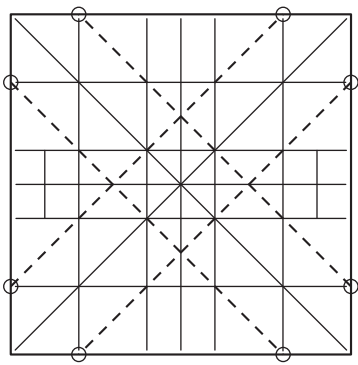

折出折痕

11

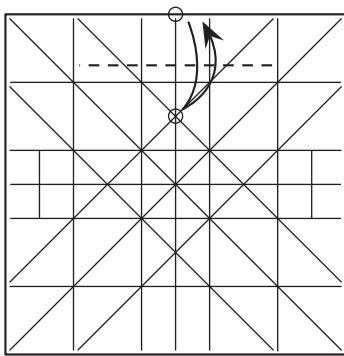

12

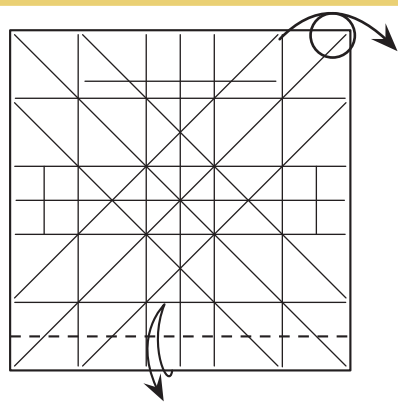

13

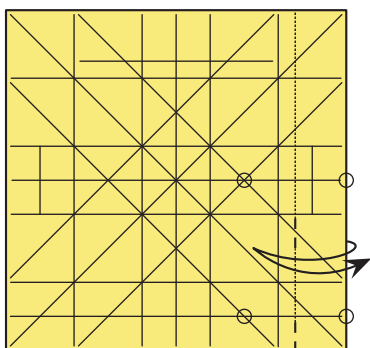

14

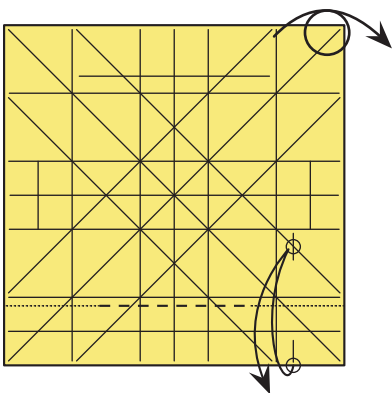

15

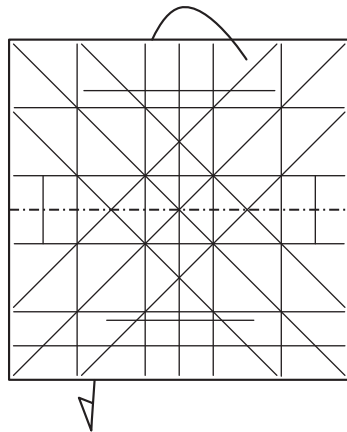

16

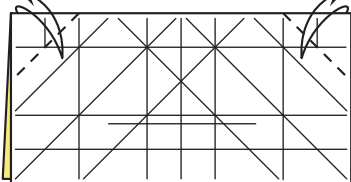

17

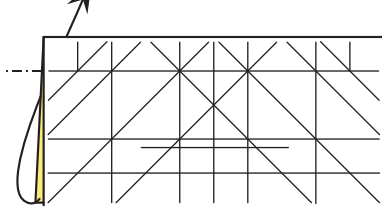

18

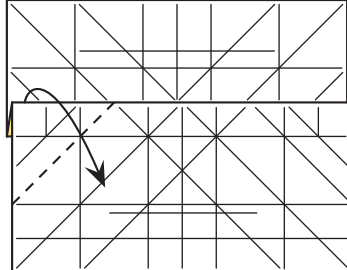

立体步骤

19

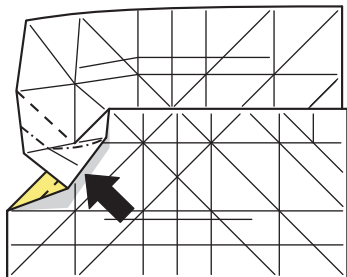

分出峰谷压平

20

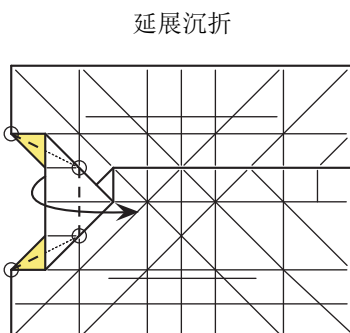

延展沉折

同方向旋转折压平

21

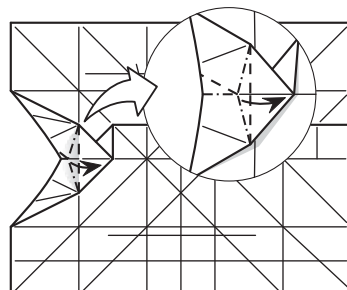

捏住压平，局部放大

22

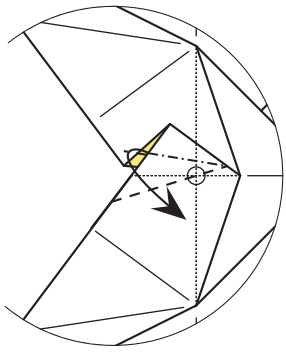

注意不要露出纸层

23

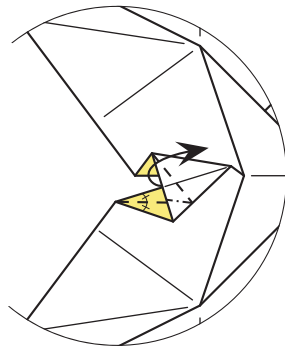

旋转折

24

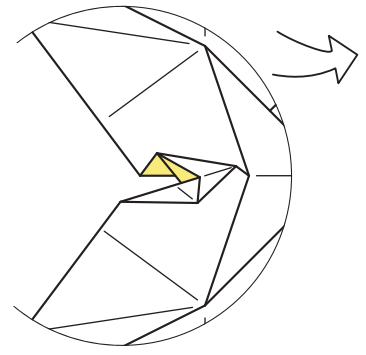

25

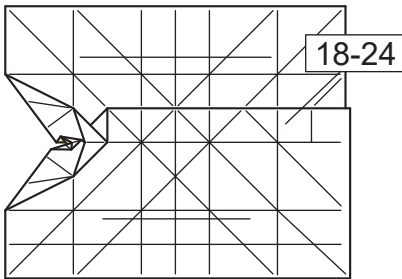

右侧重复步骤18-24

26

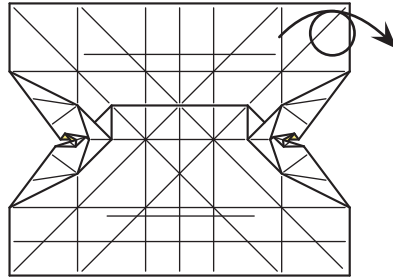

翻面

27

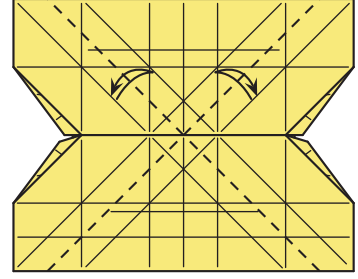

28

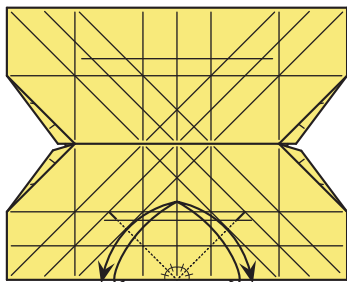

29

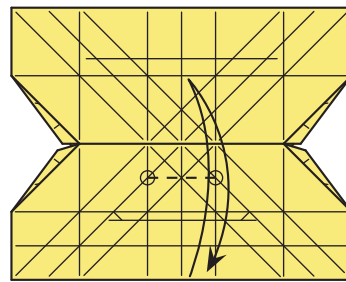

30

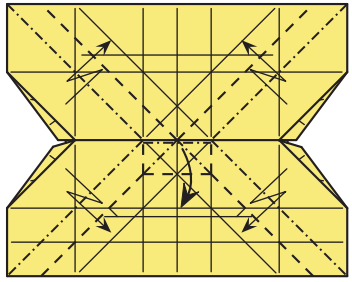

按照峰谷压平

31

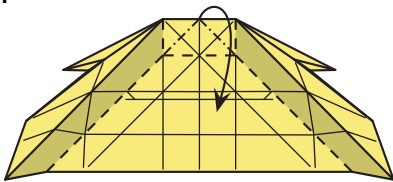

中间过程

32

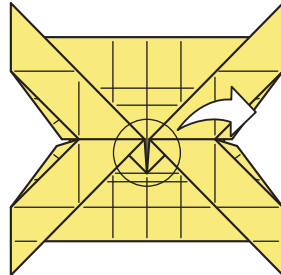

局部放大

33

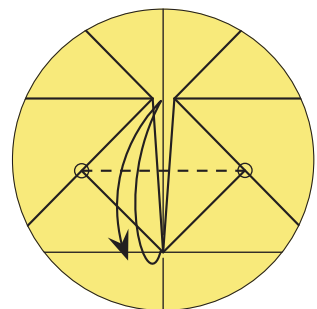

34

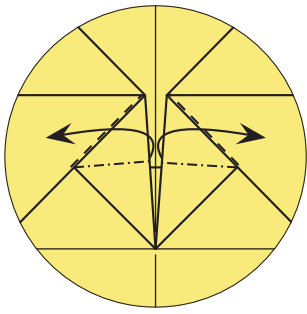

打开压平

35

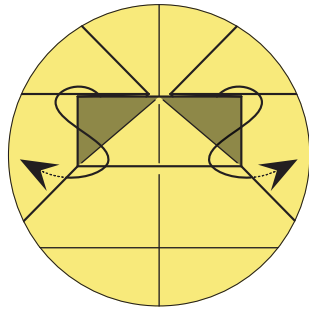

塞到后面一层

36

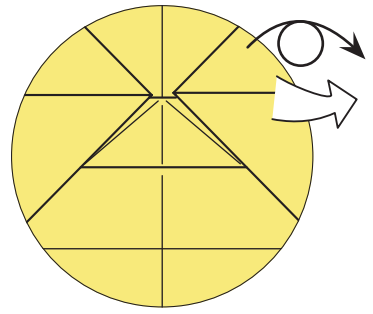

视图复原，翻面

37

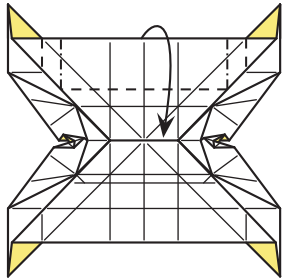

向下折叠，两边段折

38

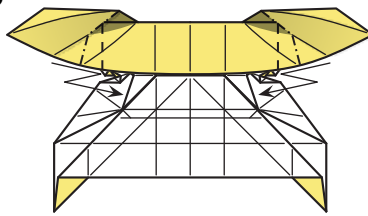

中间过程

39

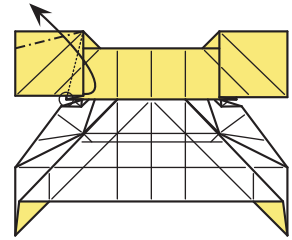

最大程度向外旋转折叠

40

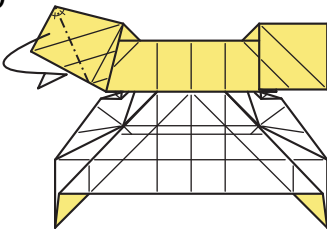

折入内部

41

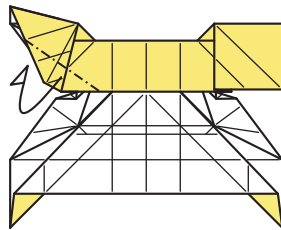

42

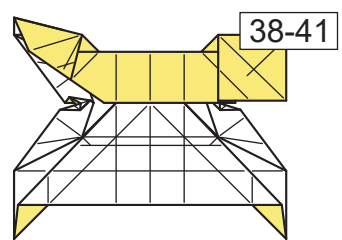

左侧重复步骤38-41

43

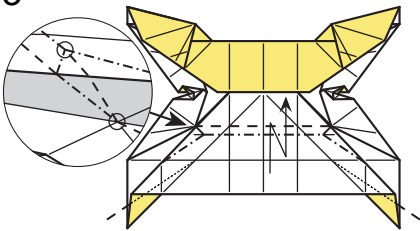

注意左侧峰谷

44

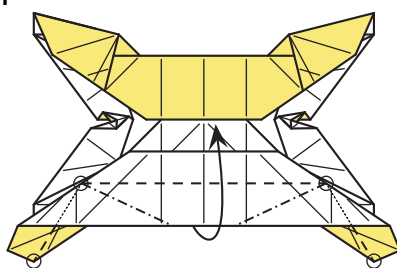

两侧同时旋转折

45

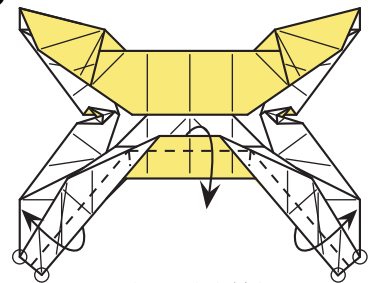

两侧同时旋转折

46

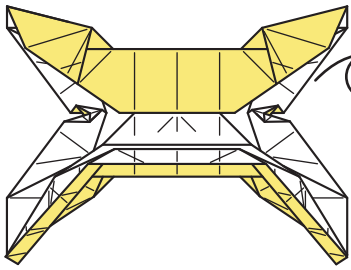

翻面

47

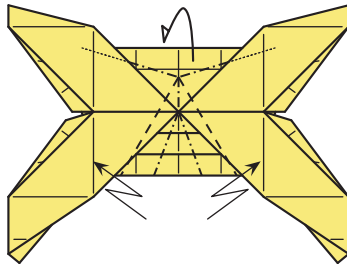

两个翅膀向中间旋转聚拢，中间是立体的

48

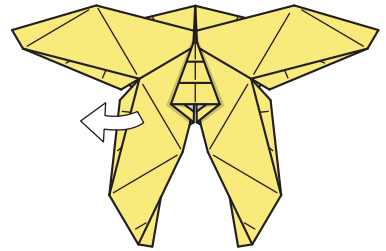

将翅膀拉开

49

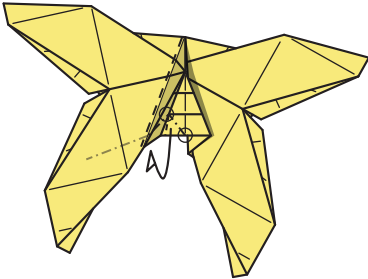

向内旋转折叠

50

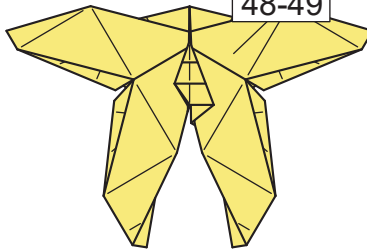

右侧重复步骤48-49

51

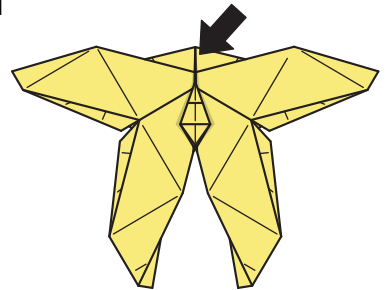

压平

52

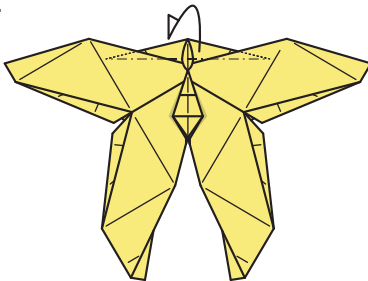

53

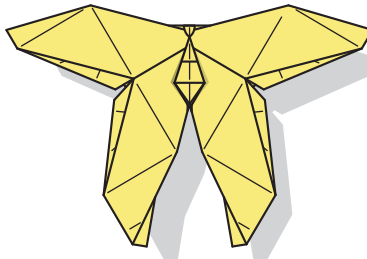

完成!





# 蛰伏

设计/Designer: Tosumerny  
 图示/Diagramer: 嘲风

推荐用纸/Paper :  
 - 教育折纸 24x24 cm

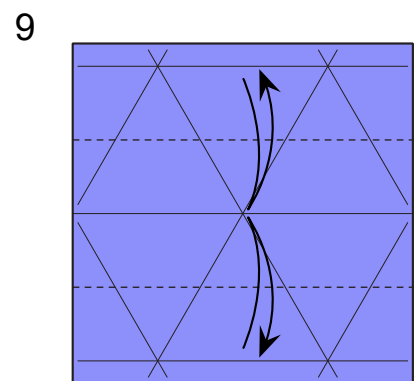
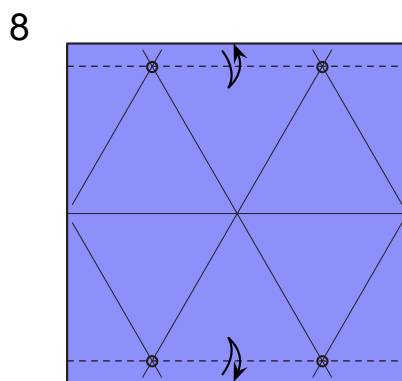
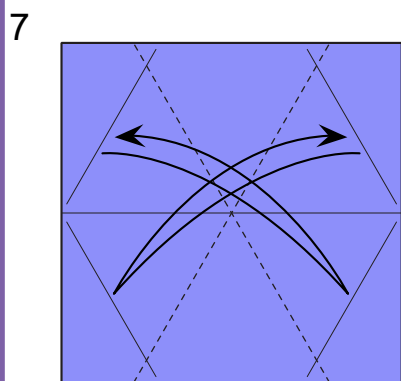
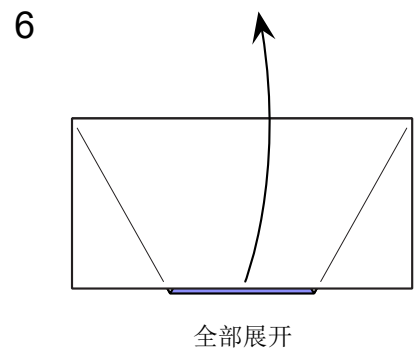
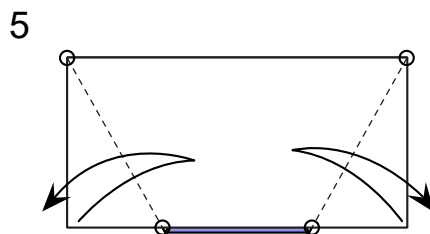
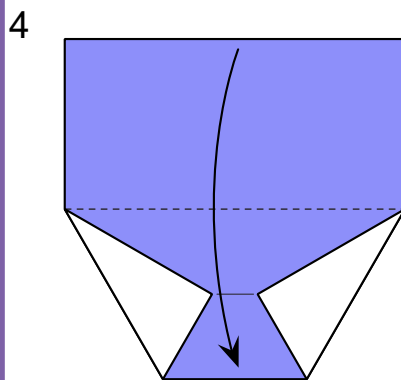
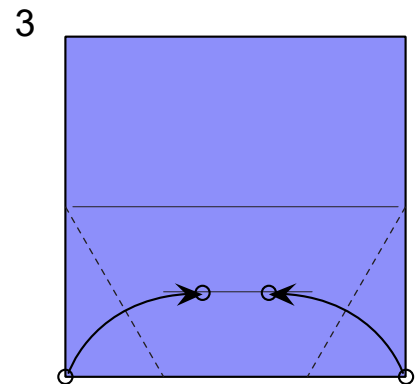
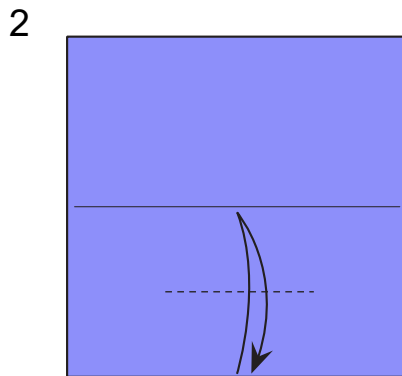
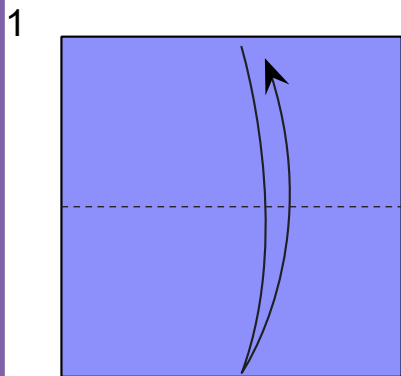
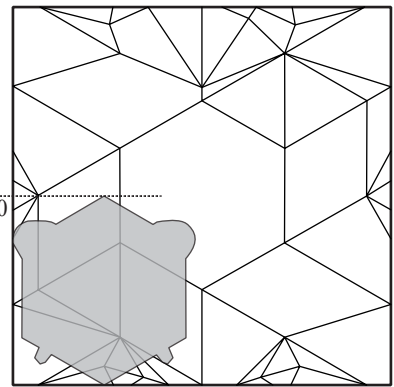
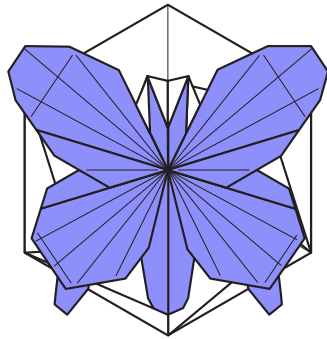

10

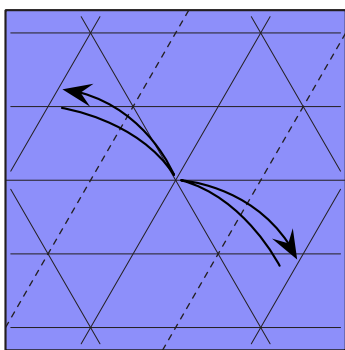

线到线

11

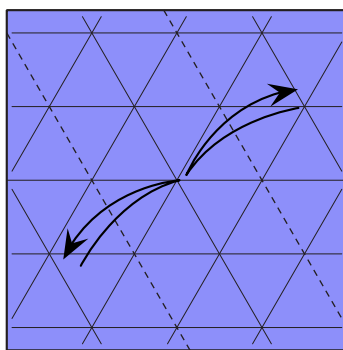

线到线

12

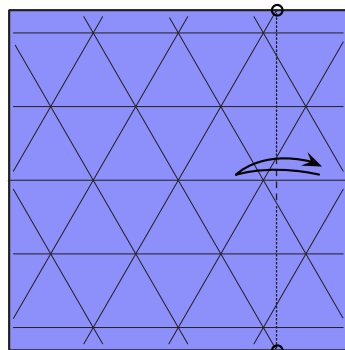

连接两点折出部分折痕

13

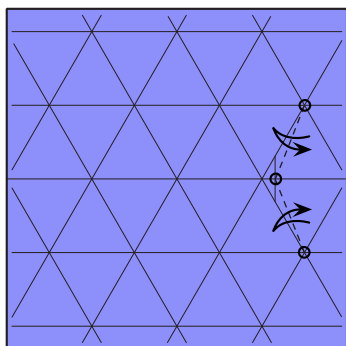

连接两点取得折痕

14

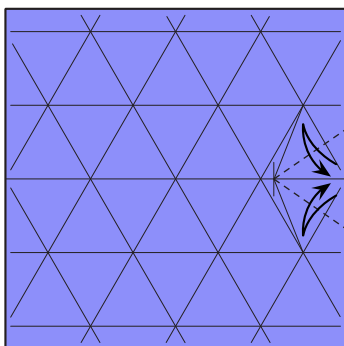

折出角平分线

15

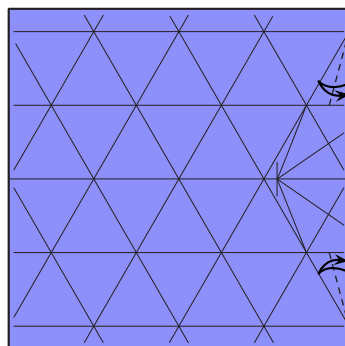

折出角平分线

16

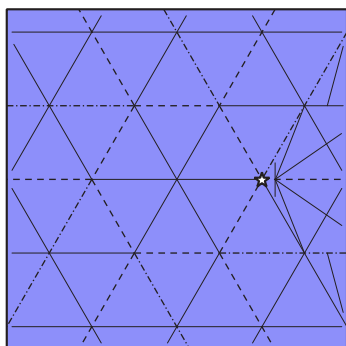

围绕中心六边，顺时针旋转折叠

17

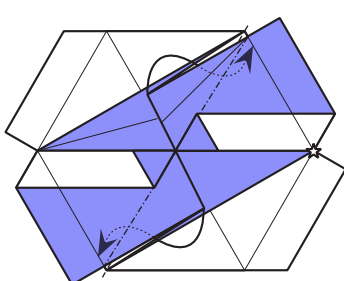

内翻折

18

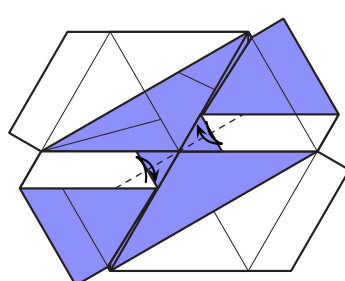

折出角平分线

19

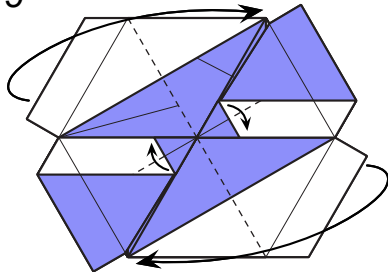

按折痕旋转

20

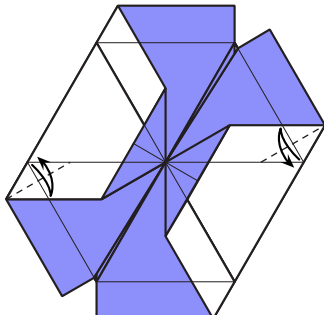

折出角平分线

21

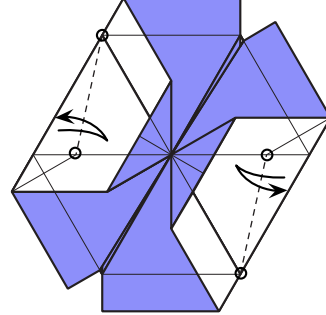

连接两点取得折痕

22

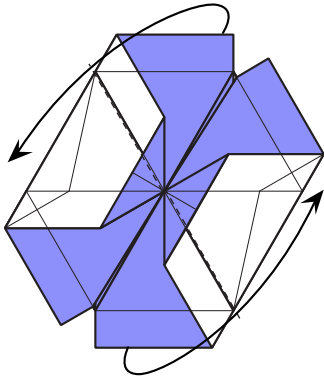

一片折叠

23

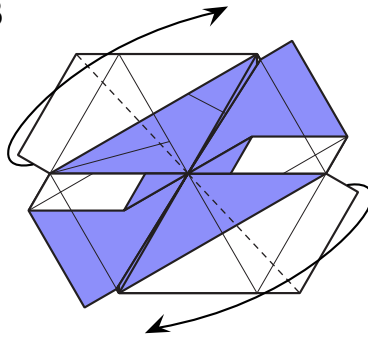

一片折叠

24

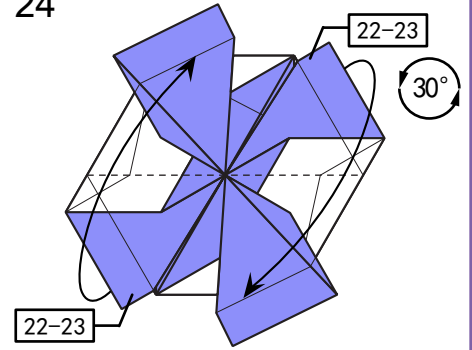

重复步骤22-23, 视图旋转

25

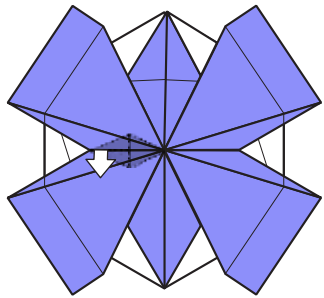

内侧纸层拉出

26

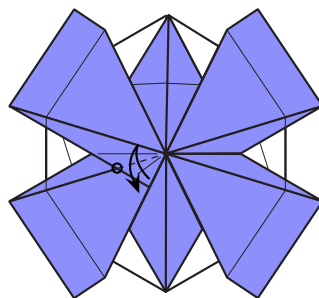

取得折痕

27

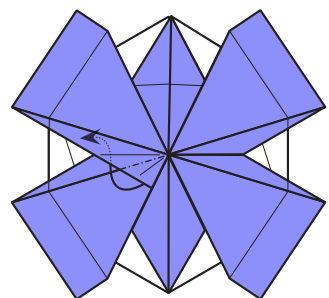

内翻折

28

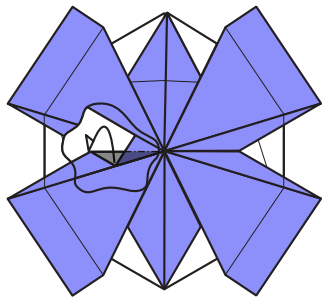

向后翻折

29

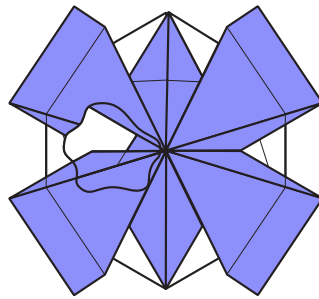

完成效果

30

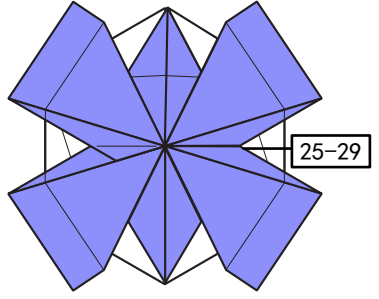

重复步骤25-29

31

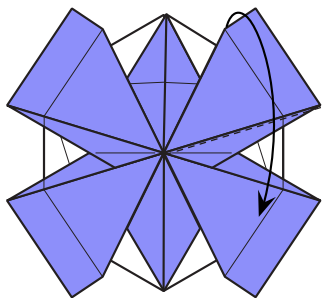

向下折叠

32

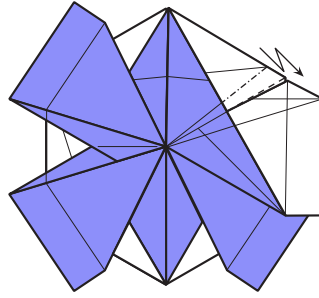

段折

33

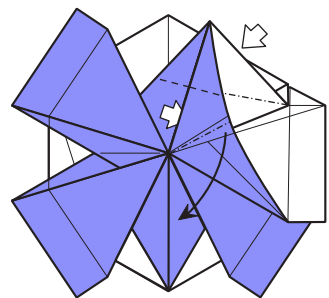

按照折痕打开压平

34

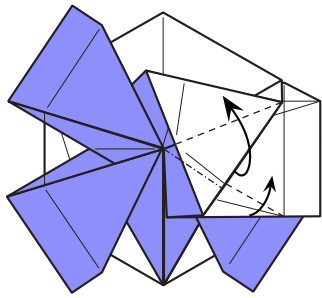

旋转打开压平

35

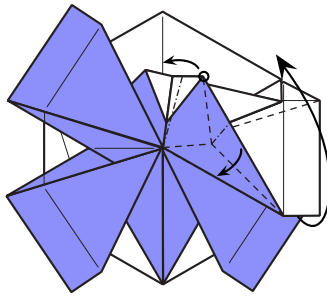

兔耳旋转折叠

36

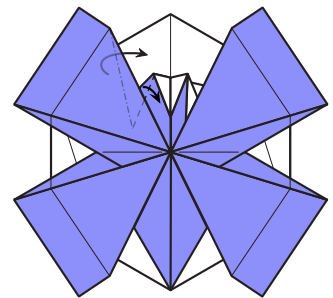

旋转折叠

37

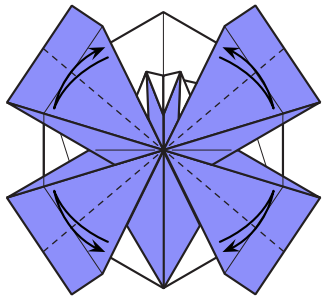

角平分线

38

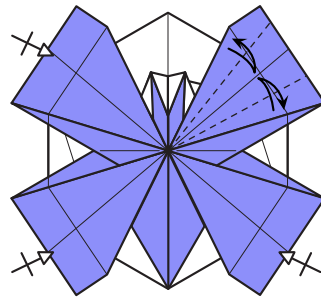

角四等分, 其余三处相同

39

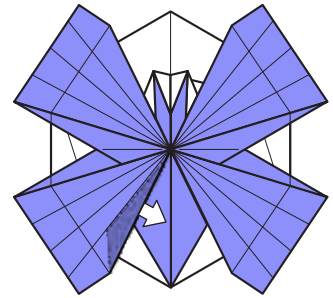

引出内部纸层

40

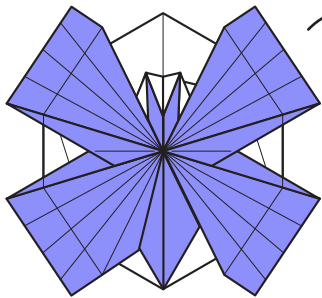

翻面

41

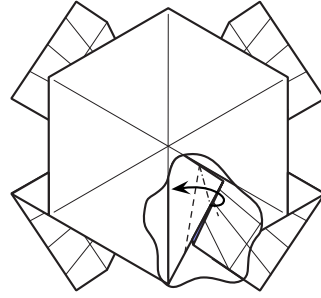

透视视角, 打开压平

42

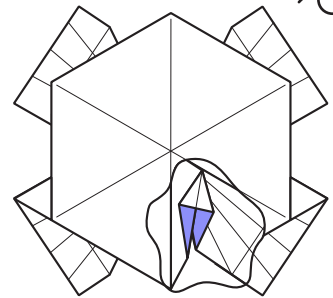

翻面

43

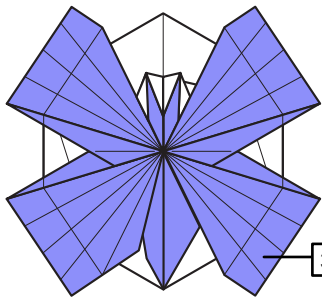

右侧重复步骤39-42

44

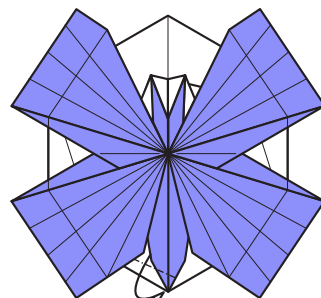

向后折

45

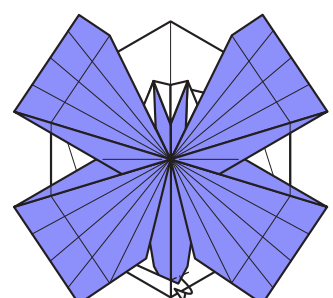

向后折

46

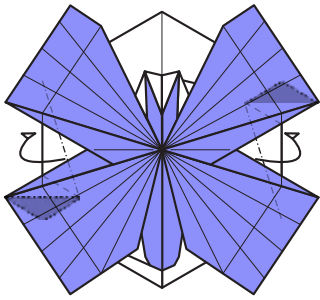

向后旋转折叠

47

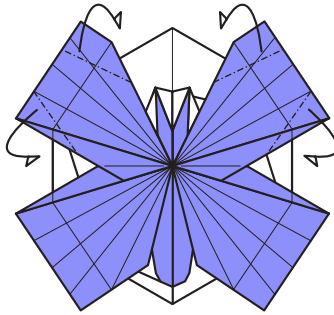

向后峰折

48

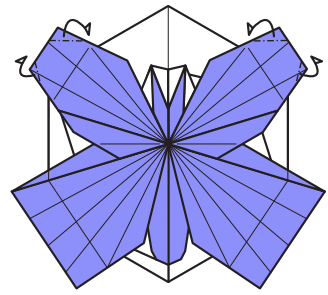

向后峰折

49

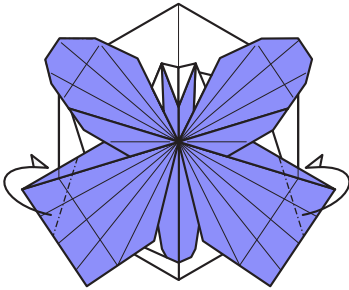

向后峰折

50

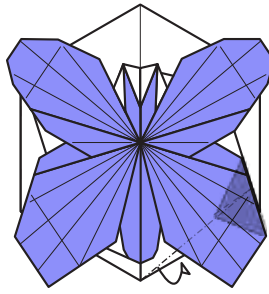

向后旋转折叠

51

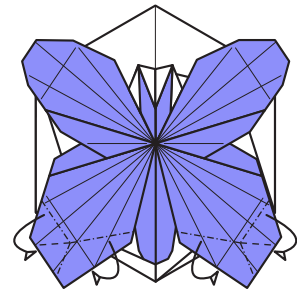

沿折痕向后聚合

52

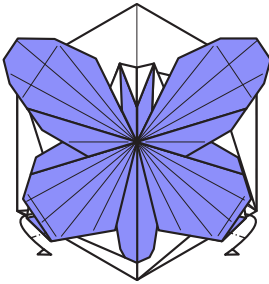

折出尾突

53

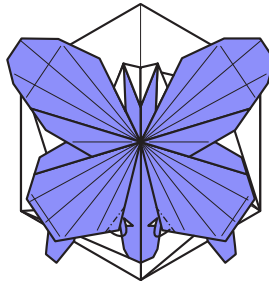

向后峰折

54

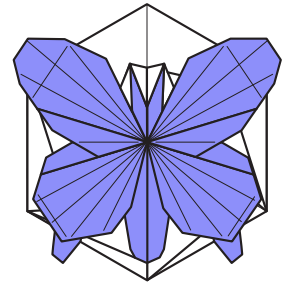

完成!



# 玫霞荡

设计/Designer: 空想  
 图示/Diagramer: 小杨

推荐用纸/Paper :  
 - 教育折纸 24x24 cm

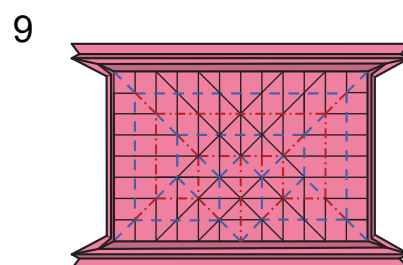
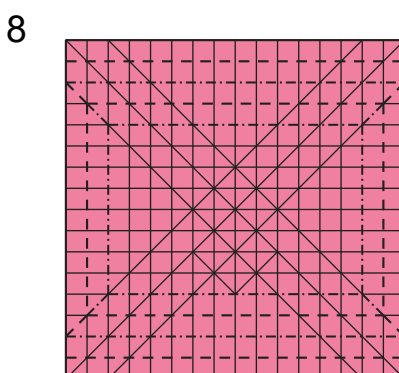
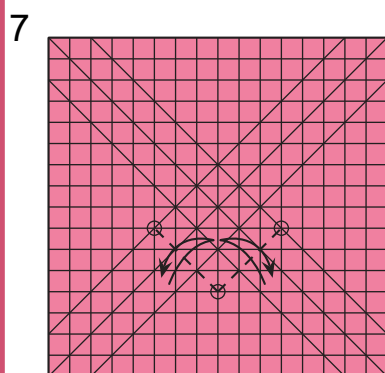
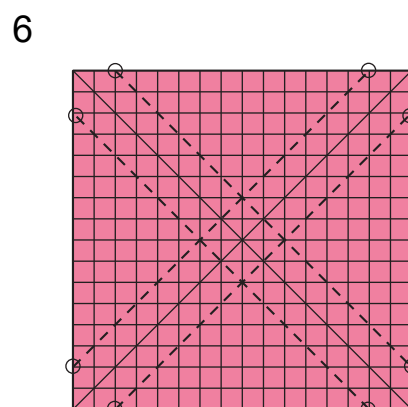
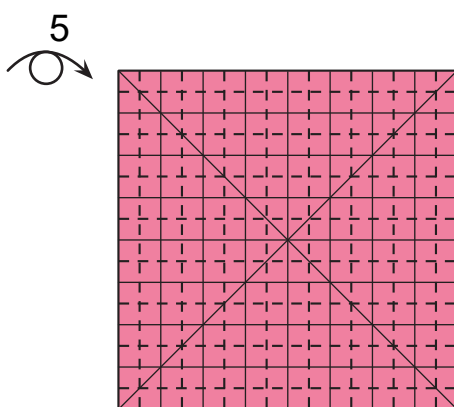
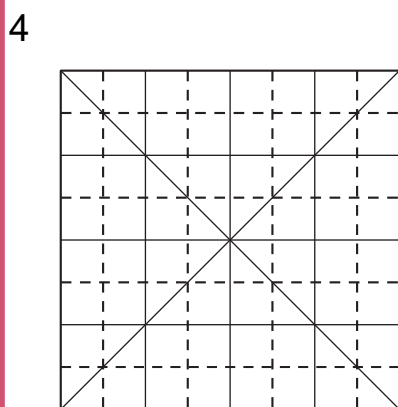
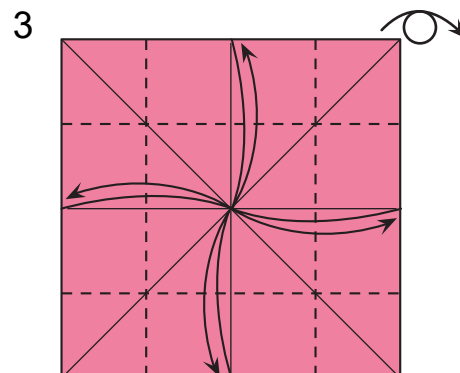
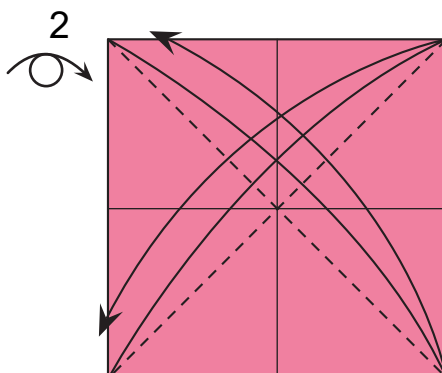
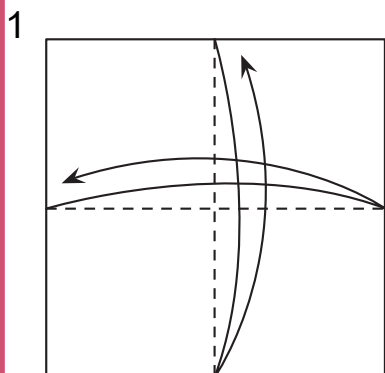
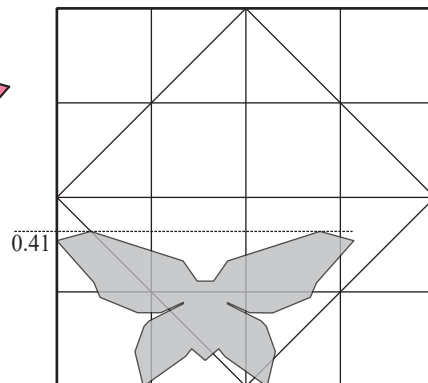
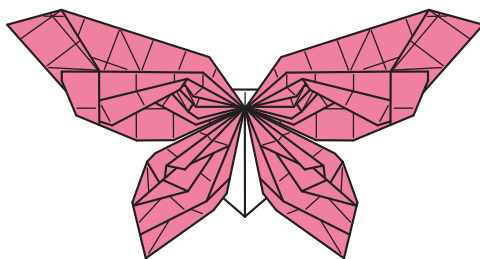

按图中峰谷聚合

按图中峰谷聚合



10

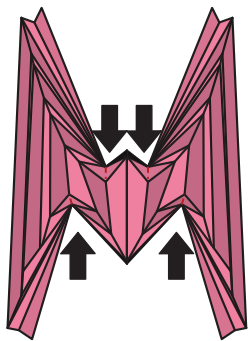

两边向中间压平

11

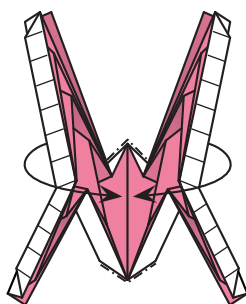

后面两个三角口袋打开压平

12



上分支折出折痕

13

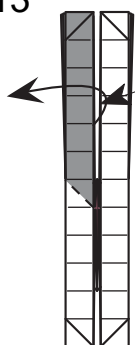

打开按照峰谷聚合

14

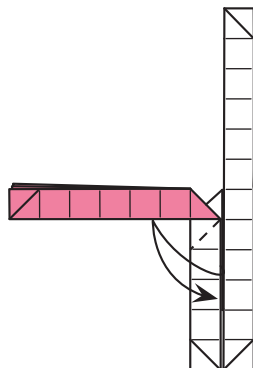

15

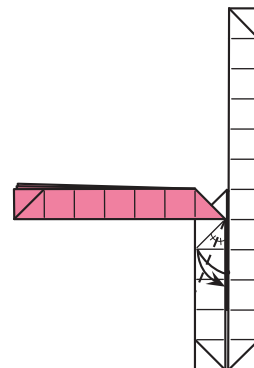

16

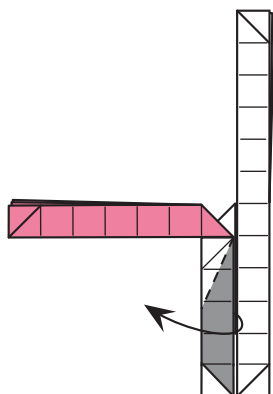

打开按照峰谷聚合

17

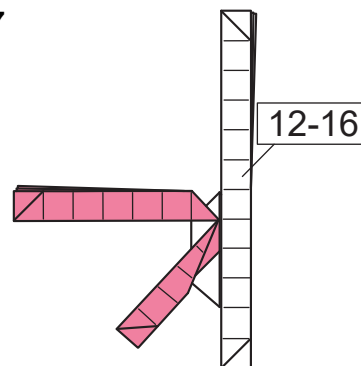

右侧重复步骤12-16

18

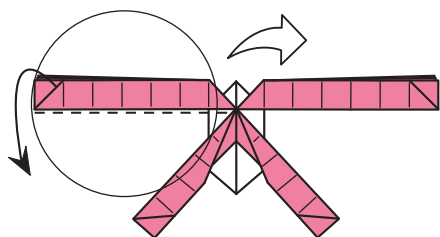

向下折，局部放大

19

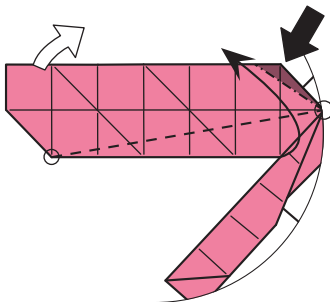

压平

20

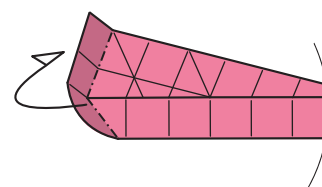

21

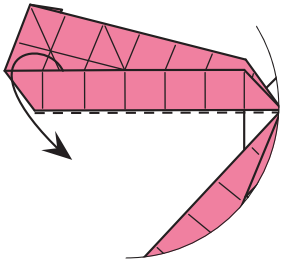

中间打开向下折

22

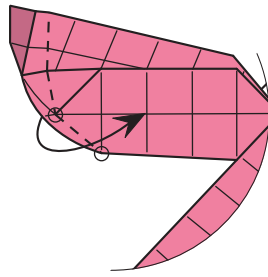

23

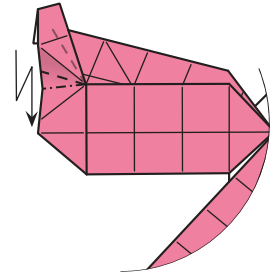

段折压平

24

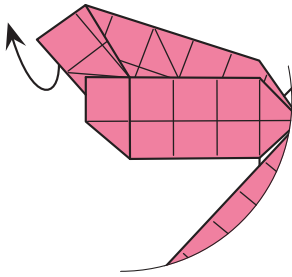

旋转展平

25

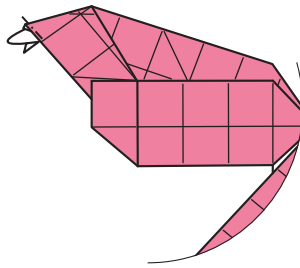

26

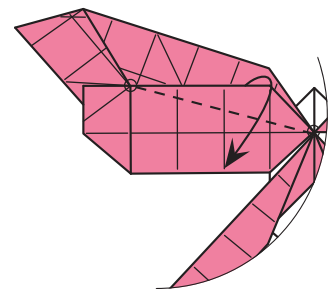

27

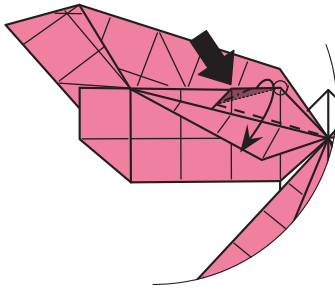

延展沉折

28

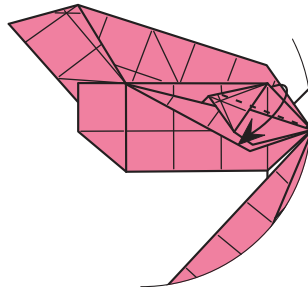

29

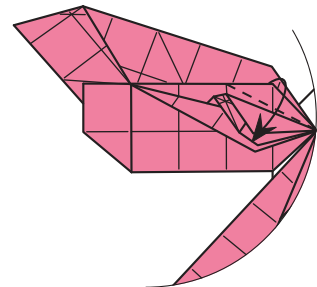

30

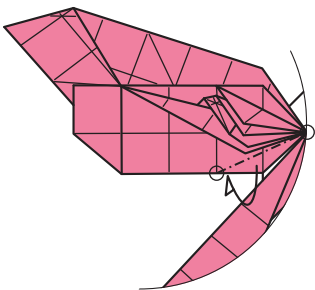

31

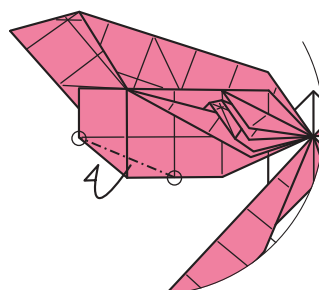

32

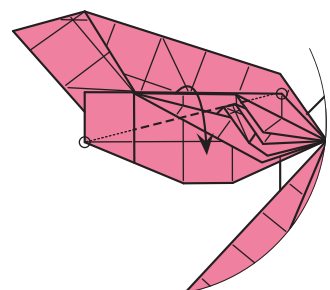

33

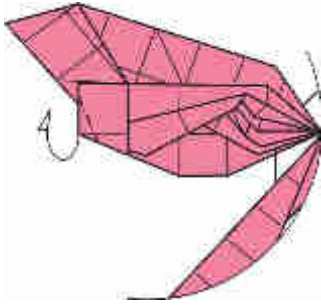

34

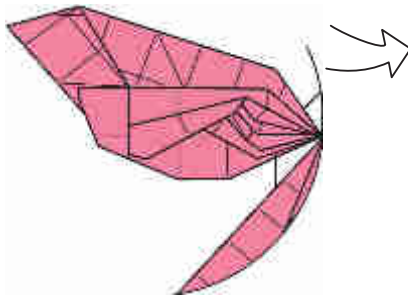

35

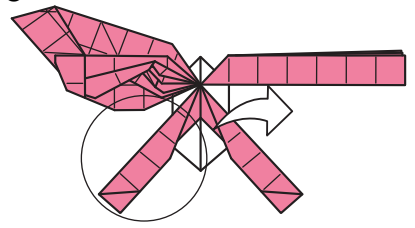

视图局部放大

视图复原

36

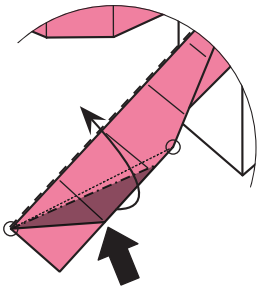

延展沉折

37

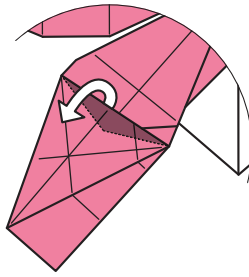

引出内部纸层

38

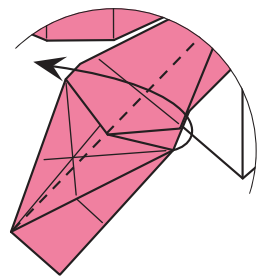

39

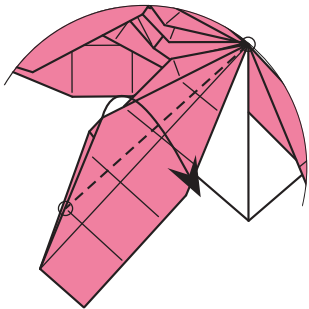

40

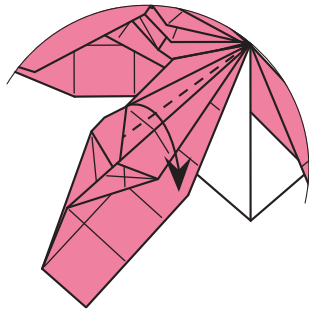

41

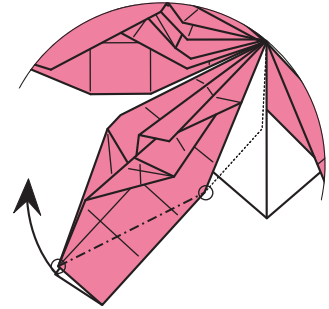

旋转折叠

42

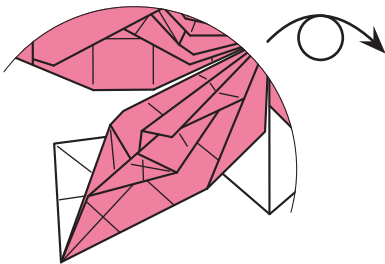

翻面

43

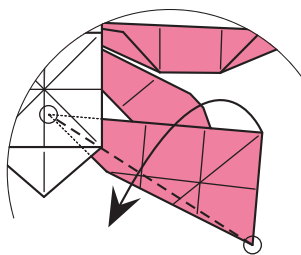

44

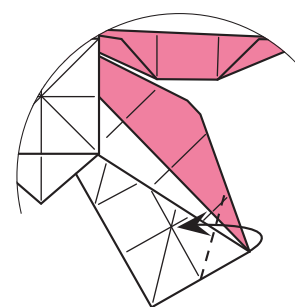

45

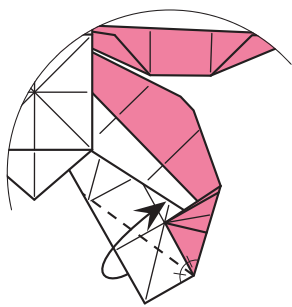

46

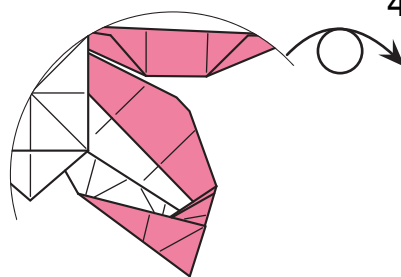

翻面

47

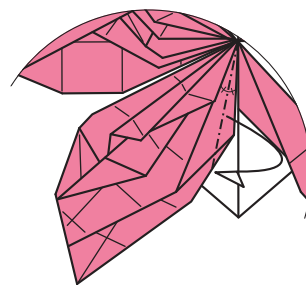

48

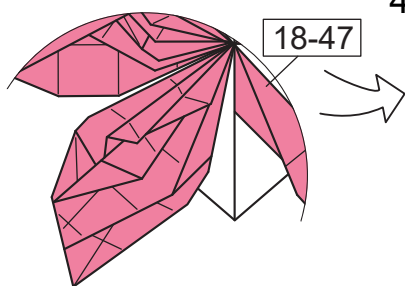

重复步骤18-47

49

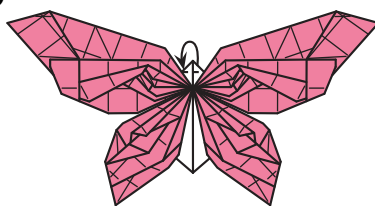

谷折

50

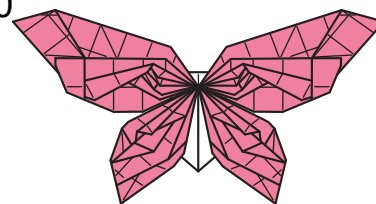

完成!

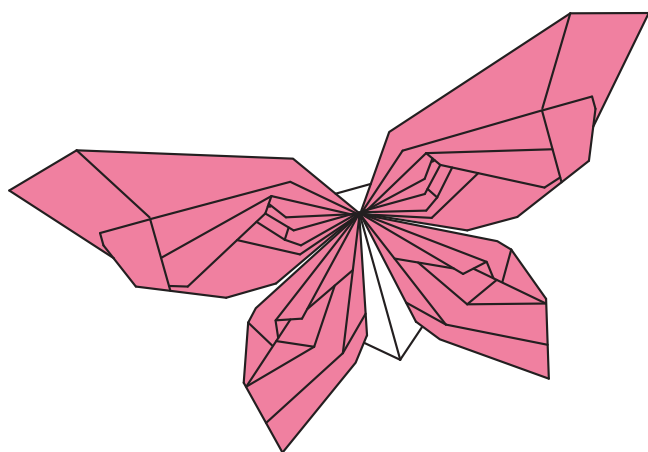

胡

蝶



# 蝴蝶

设计/Designer: 郭嵩 (五迷)  
 图示/Diagrammer: 郭嵩 (五迷)

推荐用纸/Paper :  
 - 教育折纸 15x15 cm  
 - 影纹纸 15x15 cm

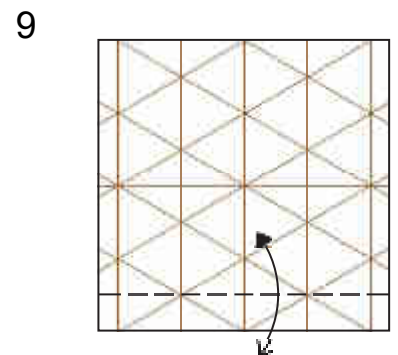
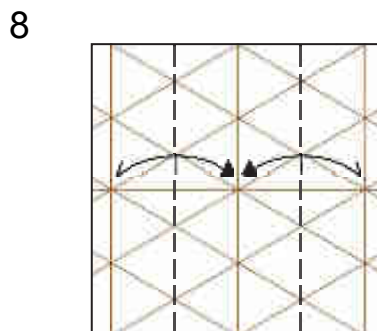
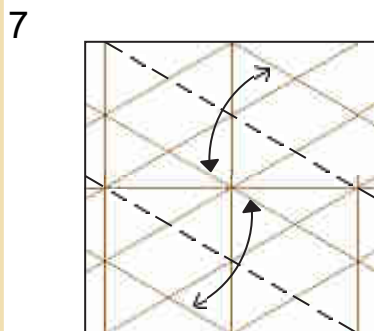
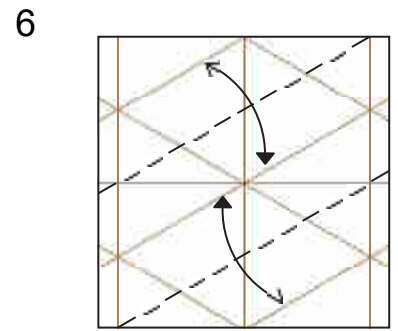
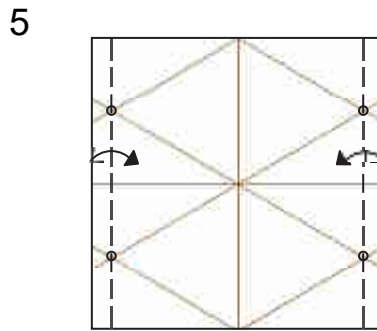
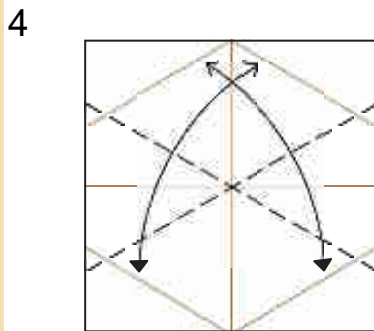
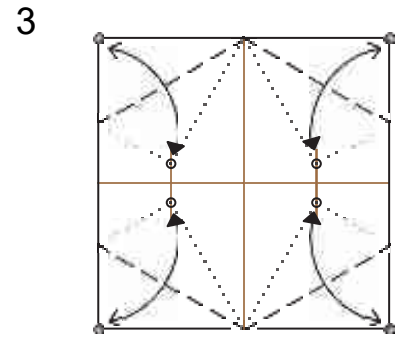
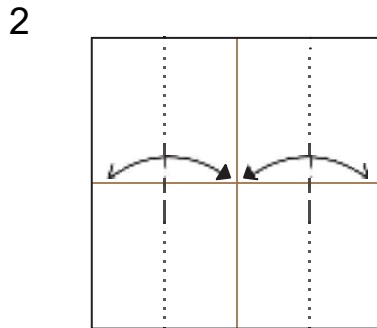
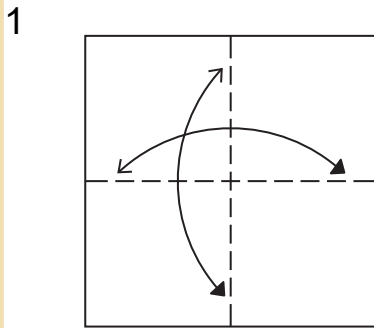
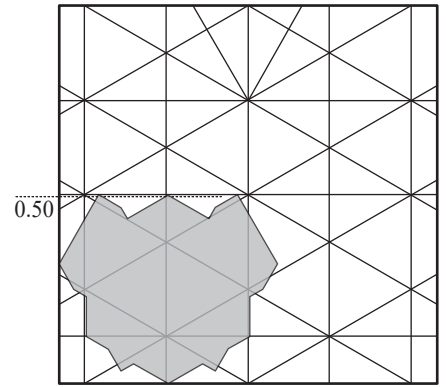
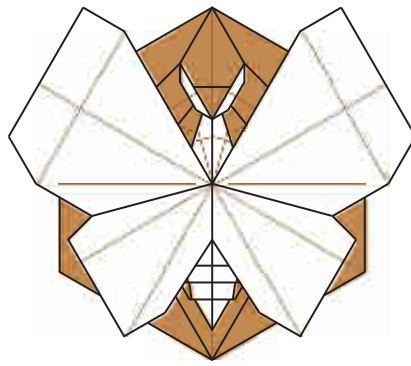

10

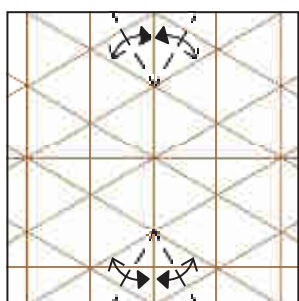

11

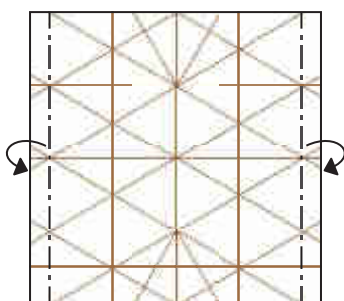

12

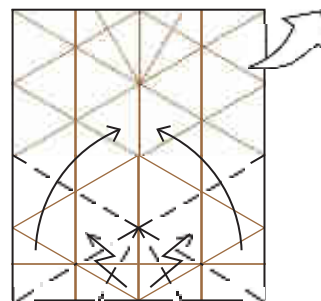

13

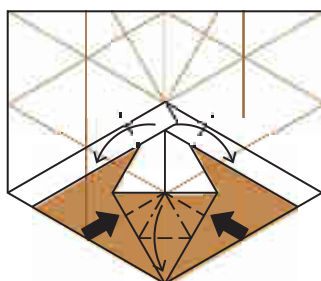

14

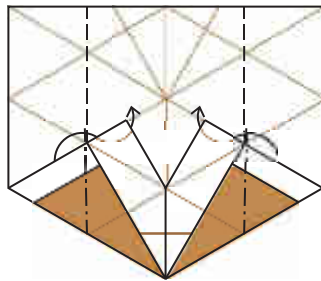

15

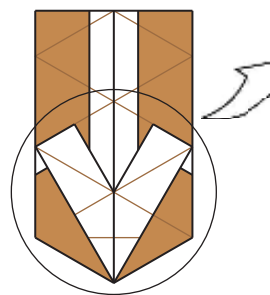

16

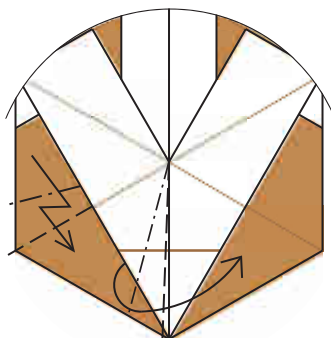

17

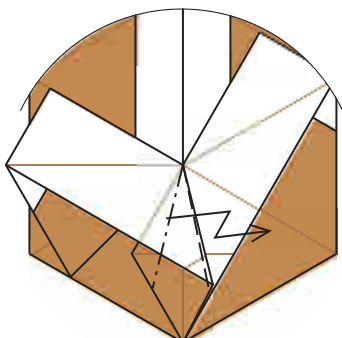

18

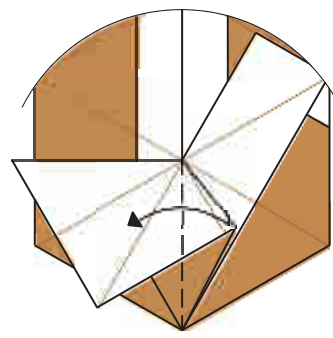

19

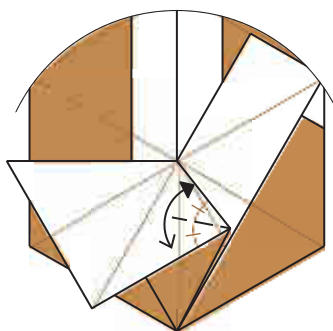

20

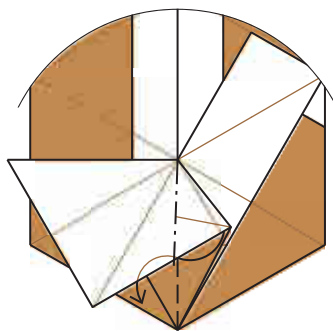

21

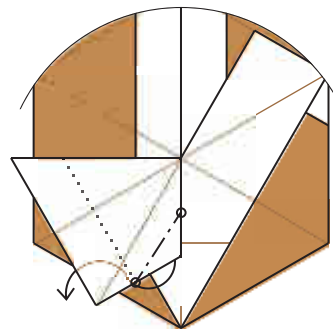



22

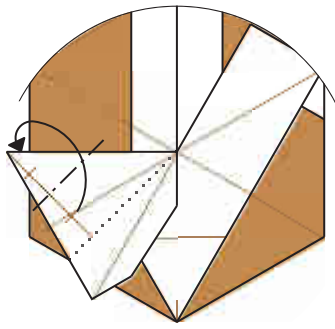

23

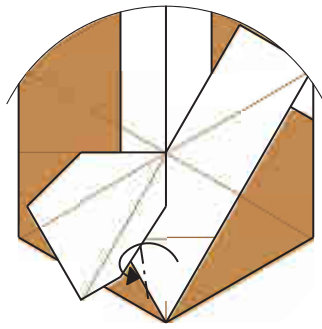

24

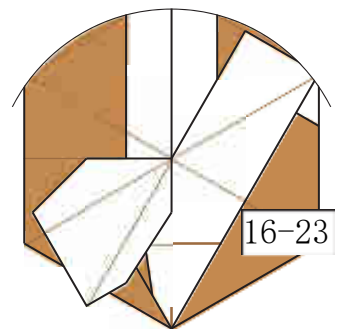

25

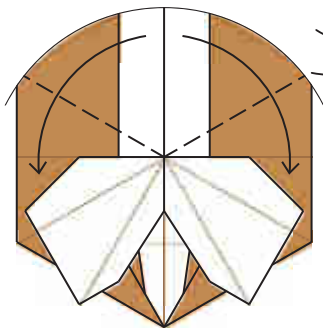

26

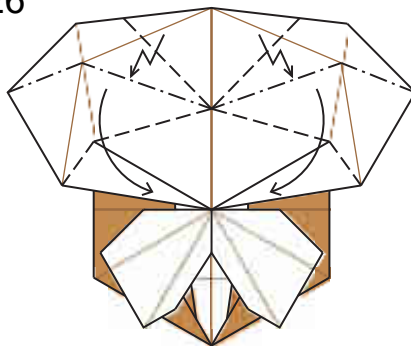

27

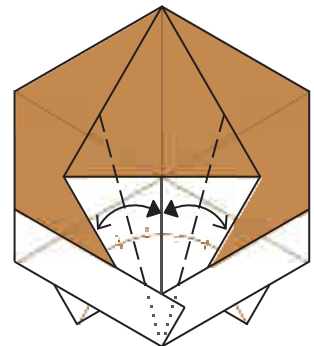

28

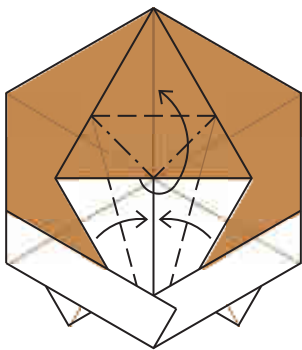

29

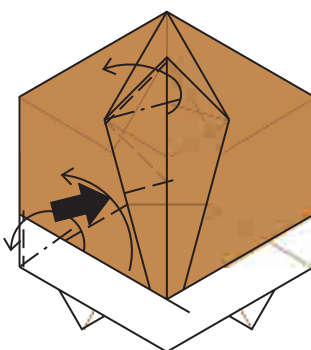

30

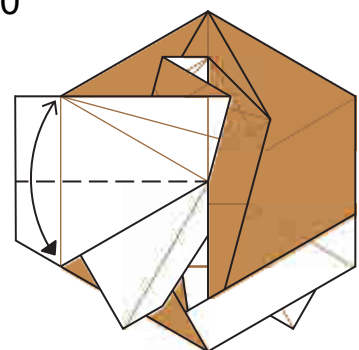

31

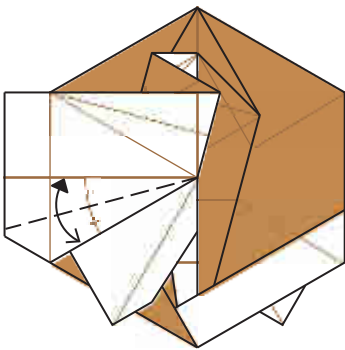

32

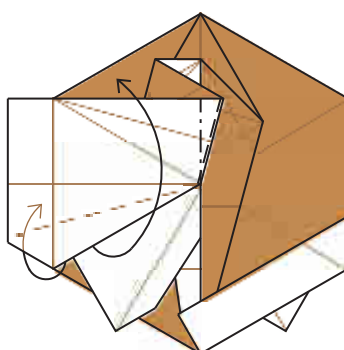

33

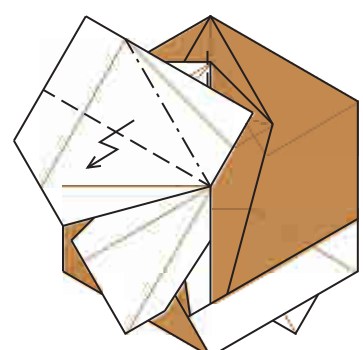

34

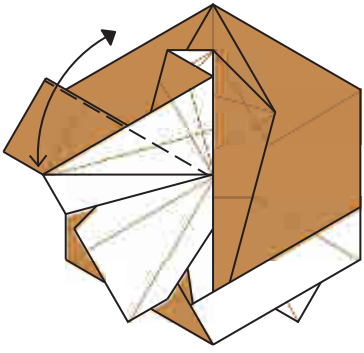

35

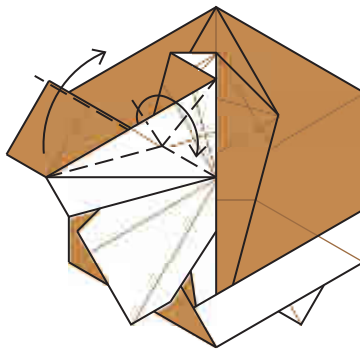

36

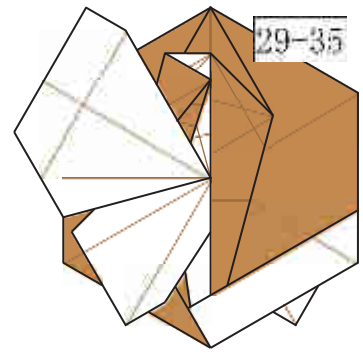

37

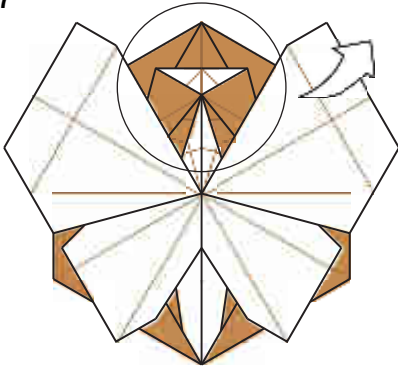

38

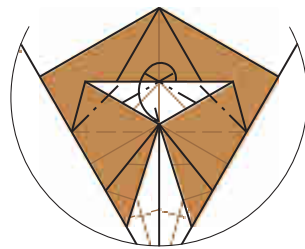

39

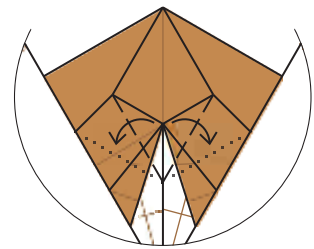

40

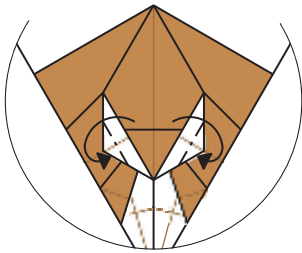

41

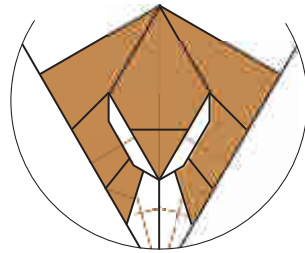

42

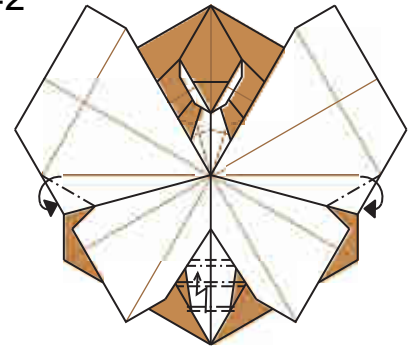

43

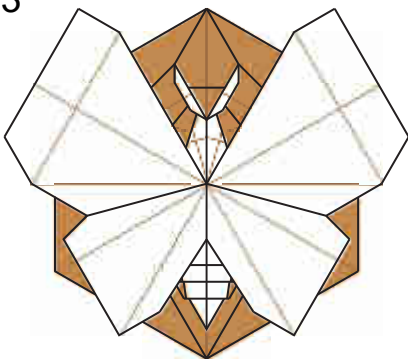



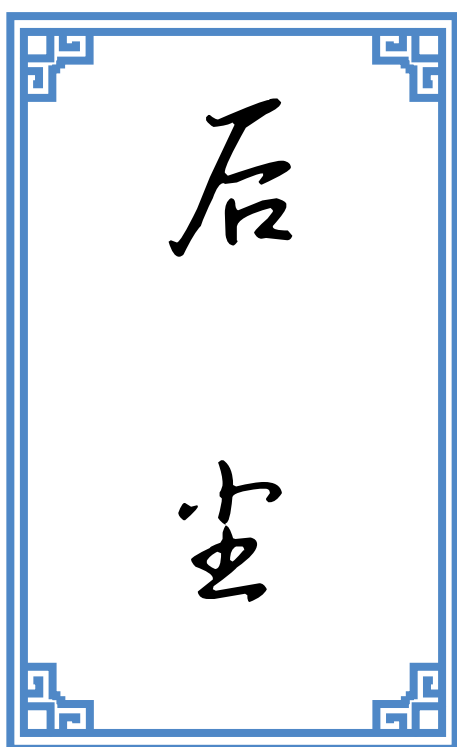

# 后尘

设计/Designer:Matsut4ke  
图示/Diagramer:Matsut4ke

推荐用纸/Paper :  
- 教育折纸 15x15 cm

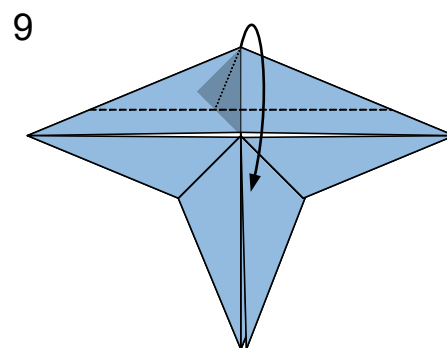
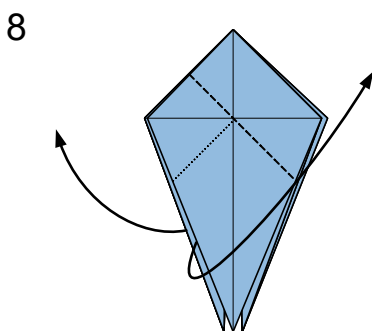
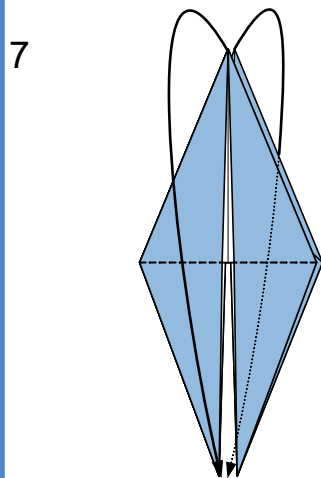
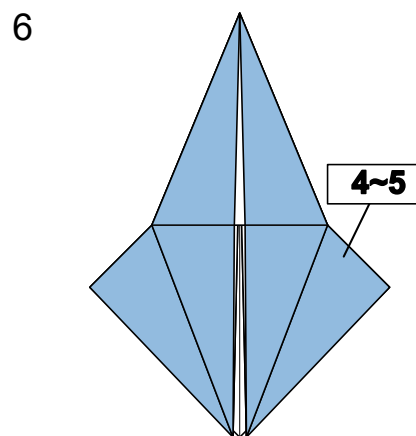
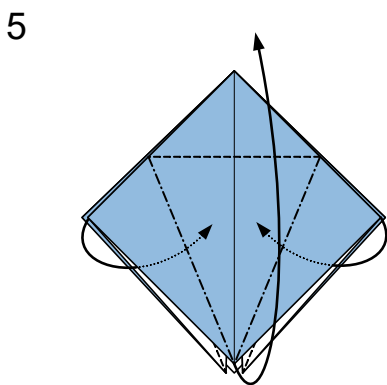
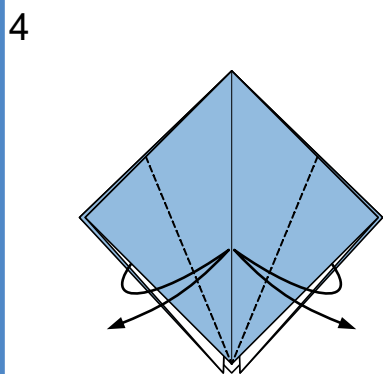
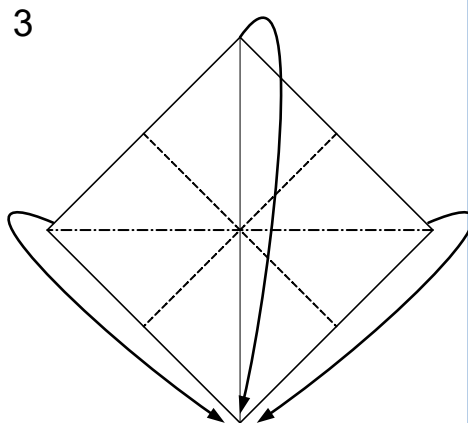
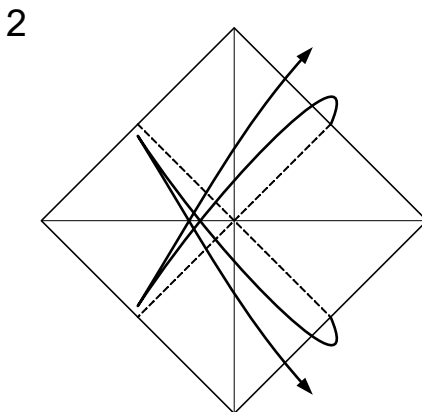
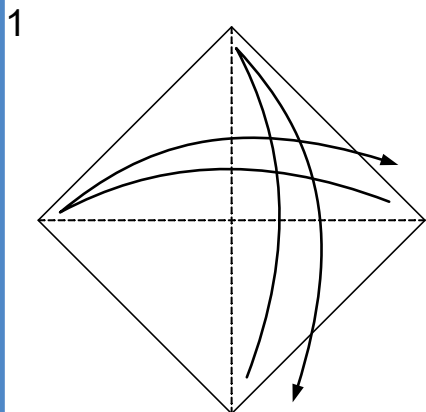
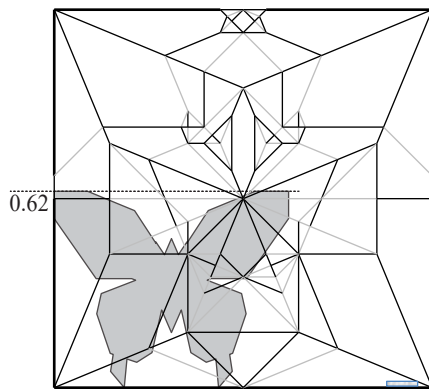
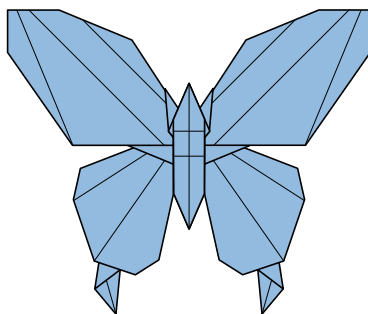

10

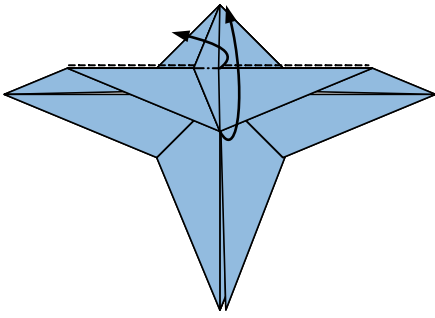

11

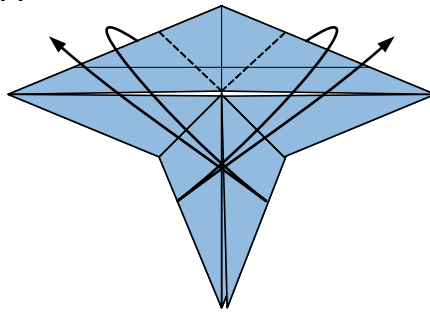

12

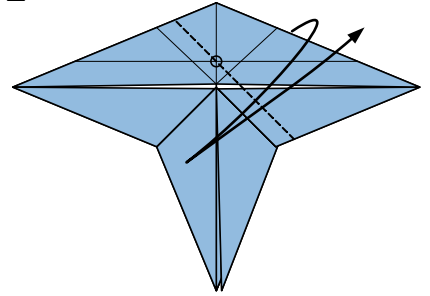

13

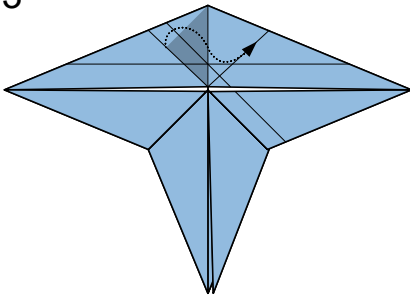

14

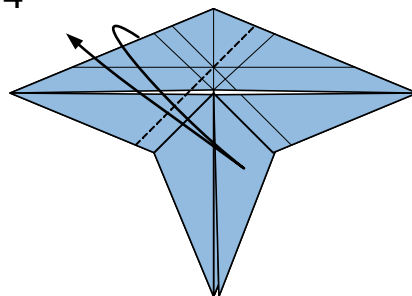

15

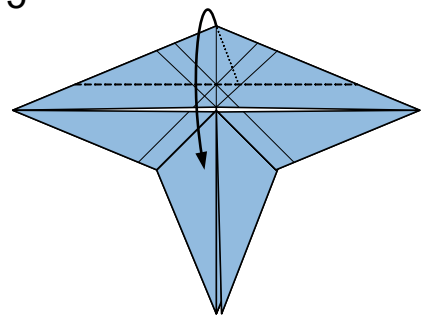

16

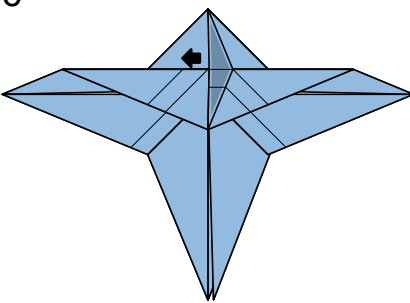

17

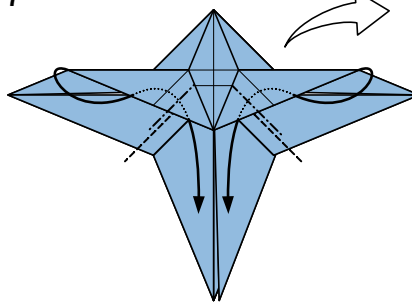

18

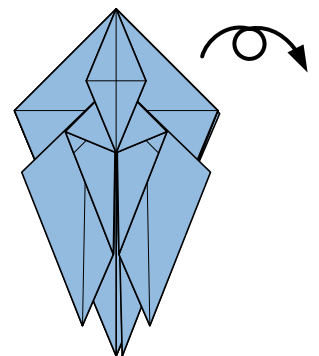

19

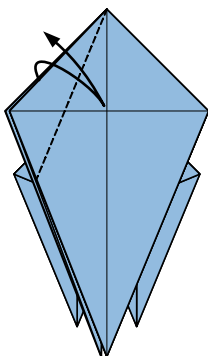

20

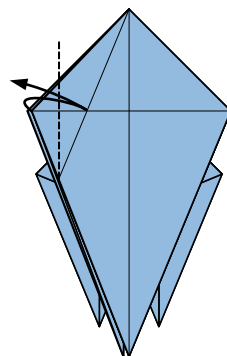

21

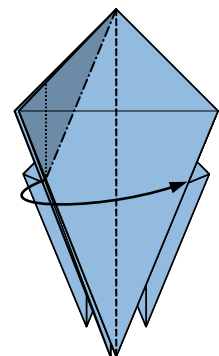

22

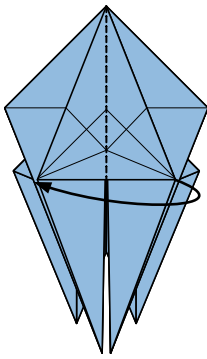

23

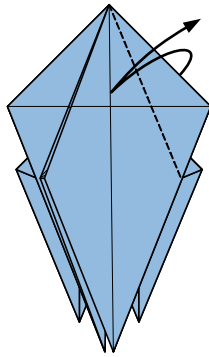

24

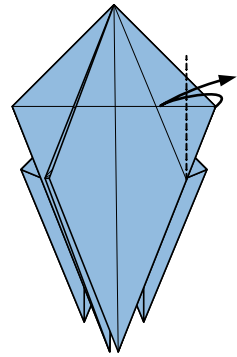

25

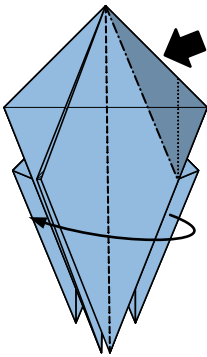

26

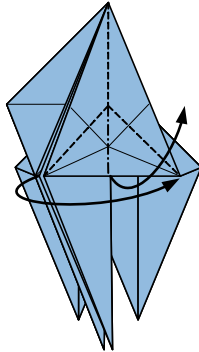

27

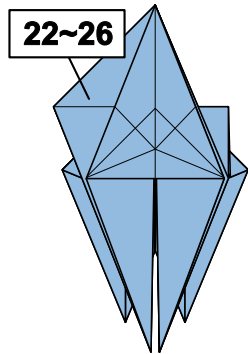

28

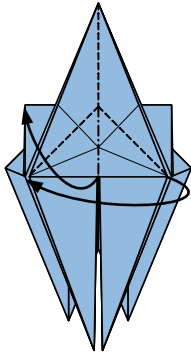

29

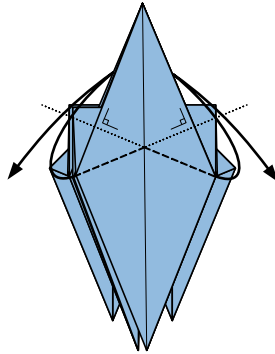

30

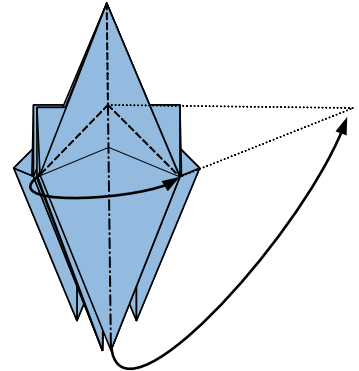

31

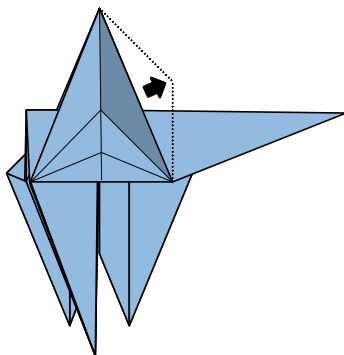

32

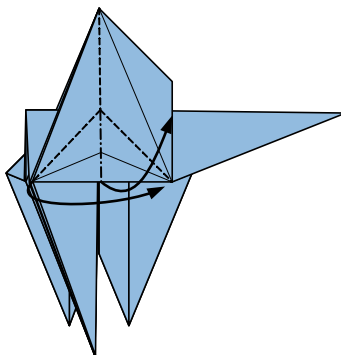

33

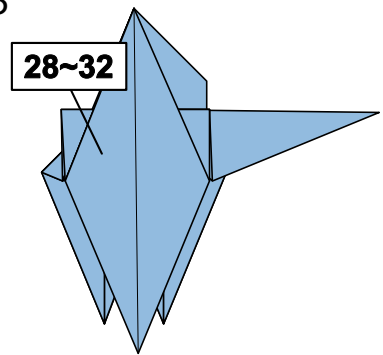

34

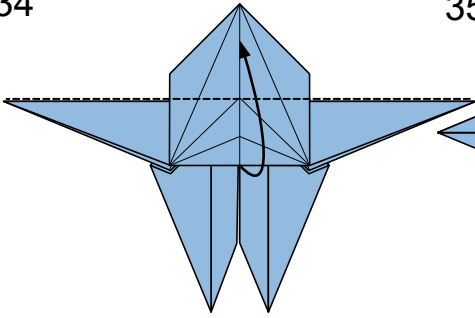

35

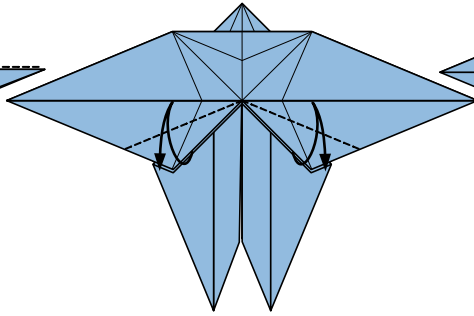

36

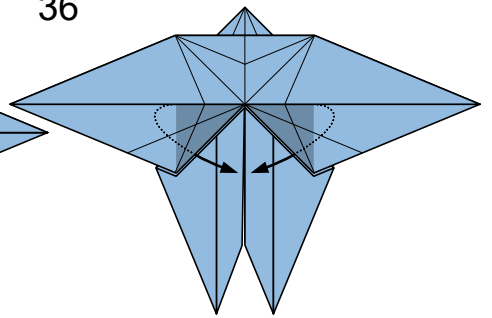

37

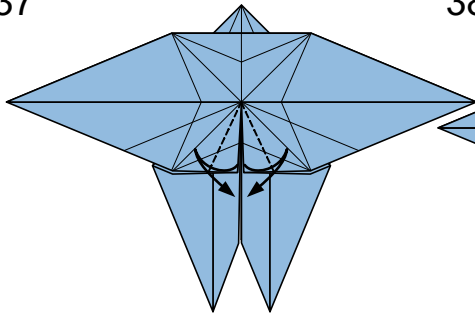

38

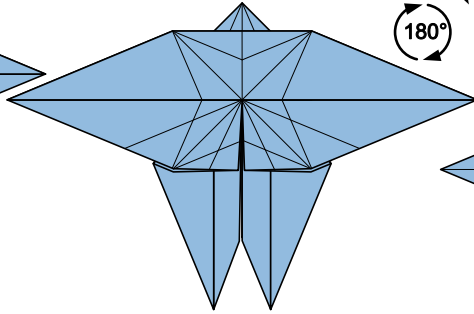

39  
180°

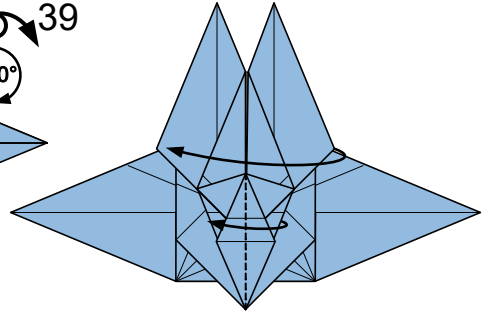

40

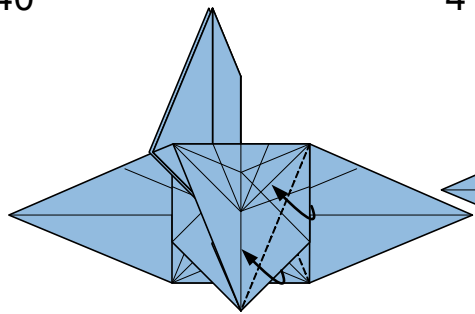

41

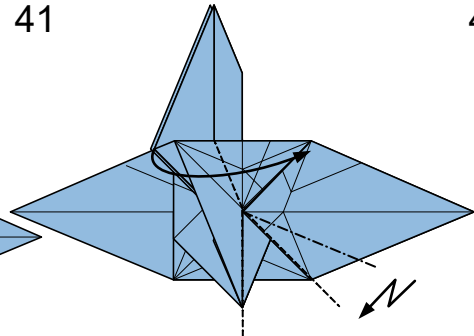

42

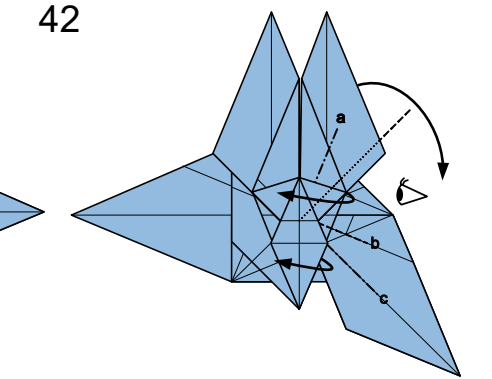

43

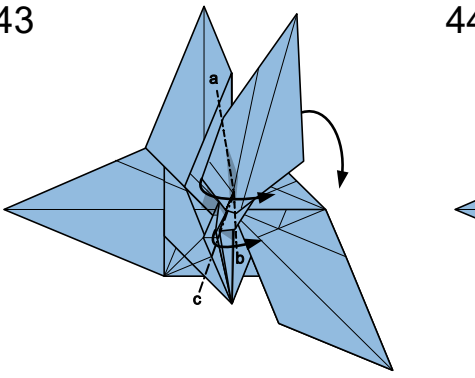

44

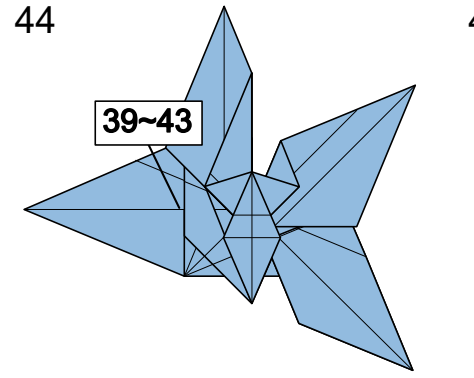

45

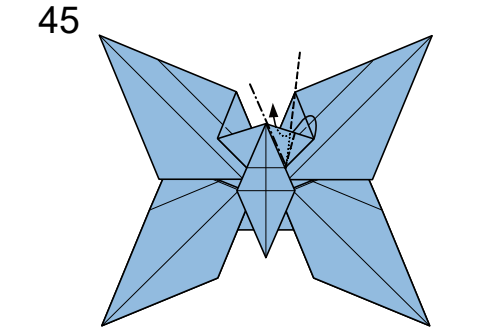



46

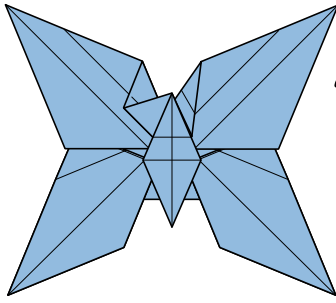

47

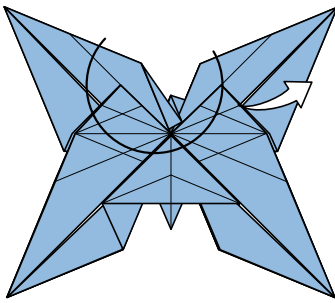

48

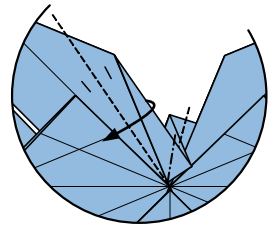

49

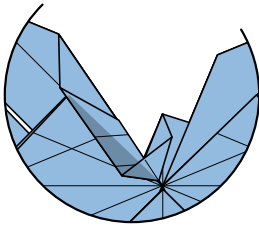

50

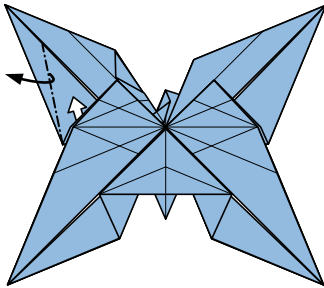

51

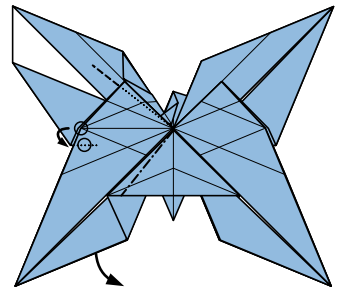

52

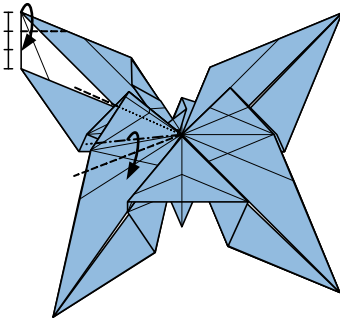

53

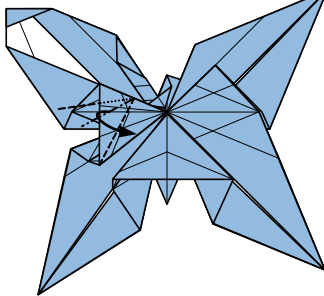

54

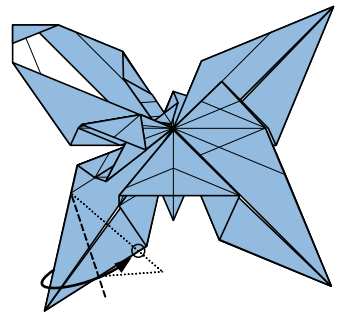

55

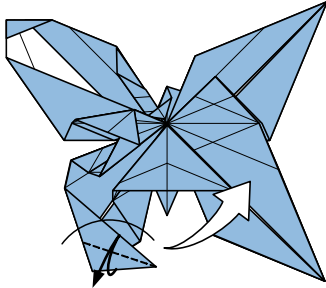

56

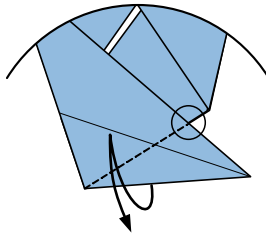

57

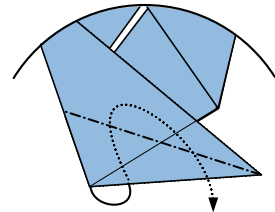

58

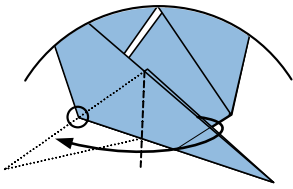

59

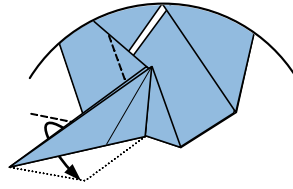

60

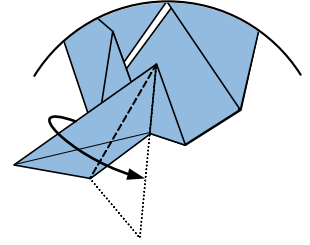

61

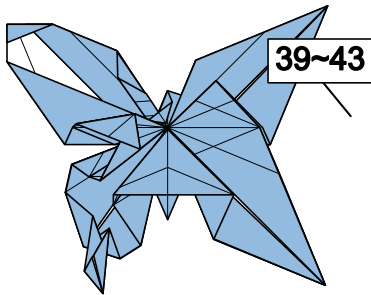

62

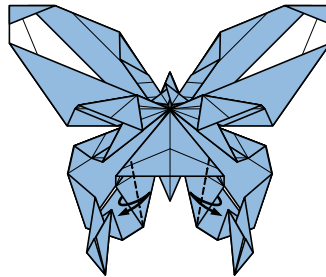

63

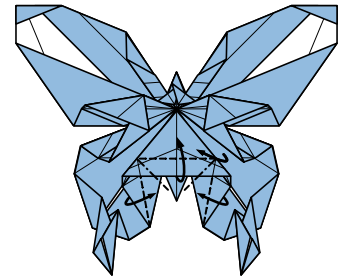

64

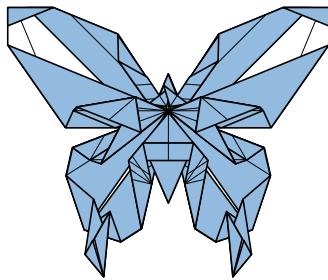

65

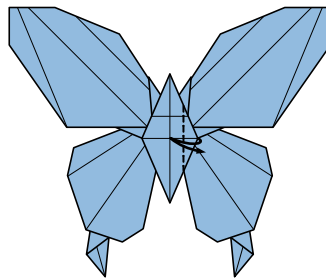

66

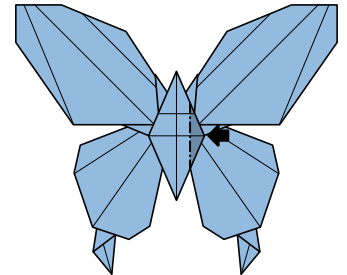

67

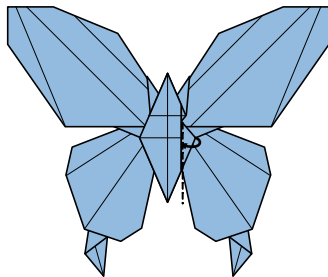

68

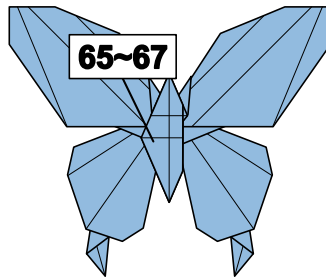

69

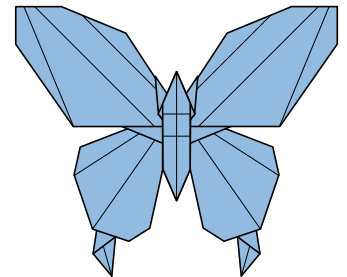



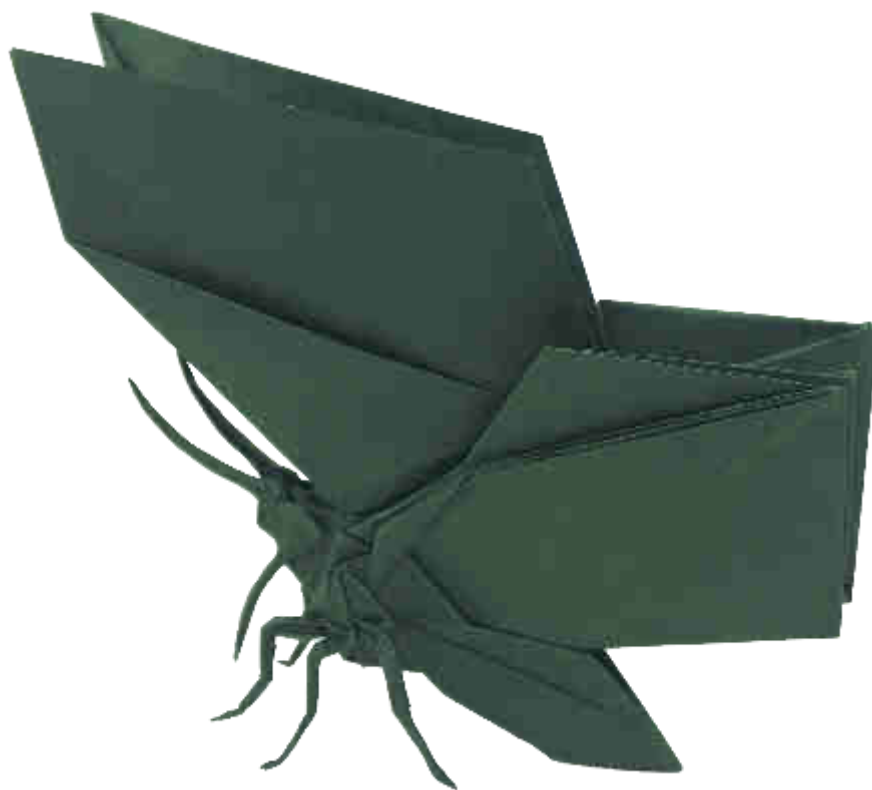

# 止水

设计/Designer: 开明  
 图示/Diagramer: 徐涛 (逍遥丸子)

推荐用纸/Paper :  
 - Biotope 50x50 cm  
 - 薄牛皮 35x35 cm

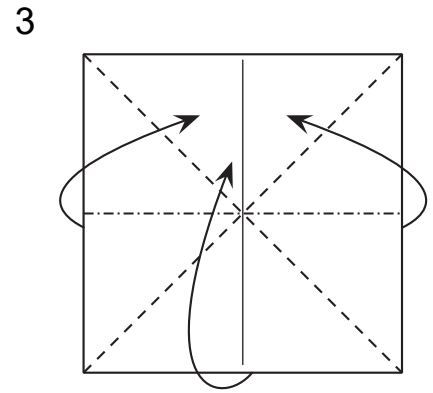
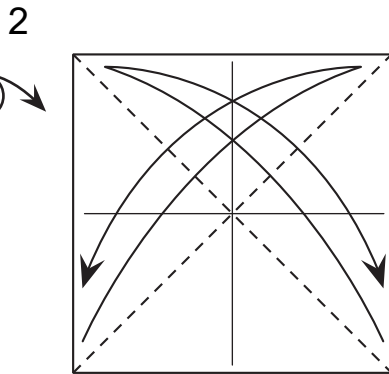
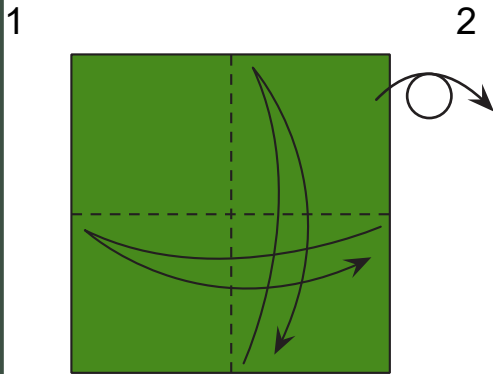
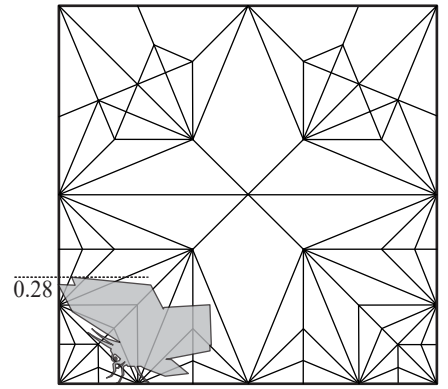
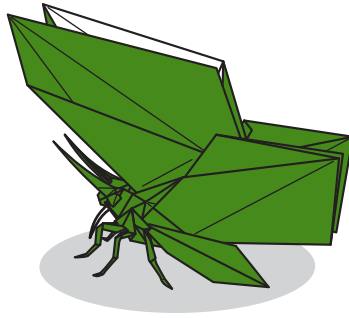

双三角形

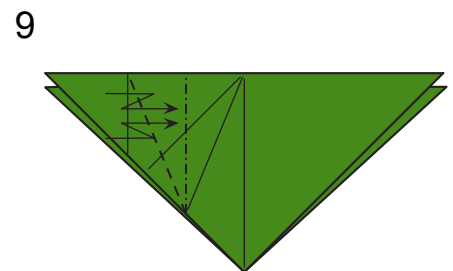
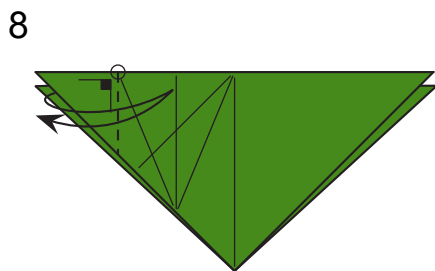
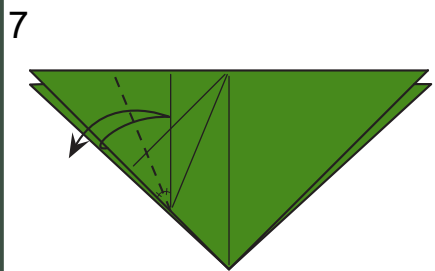
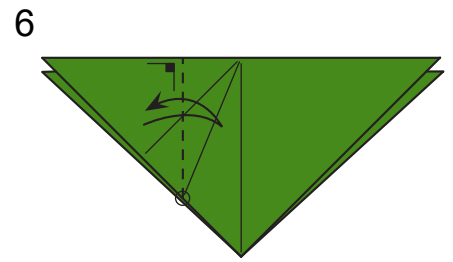
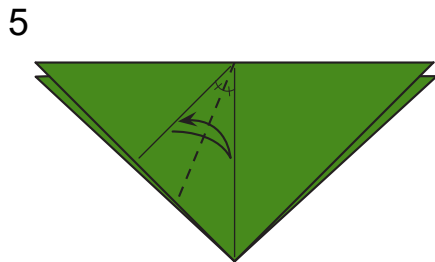
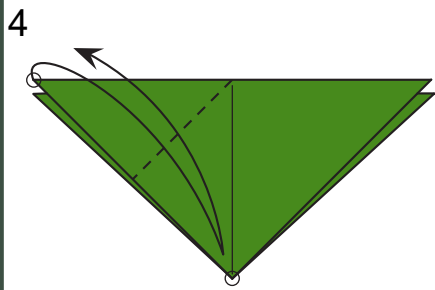

双向段折

10

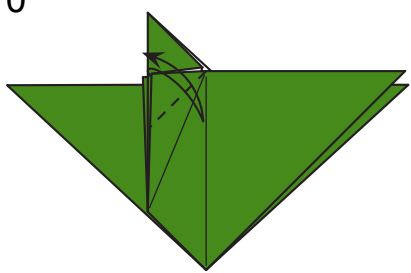

11

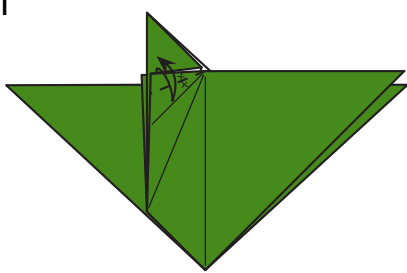

12

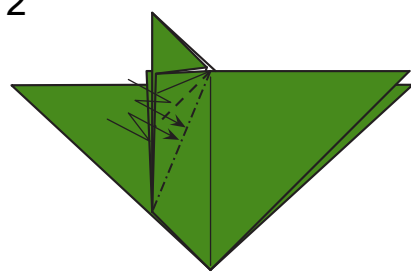

双向段折

13

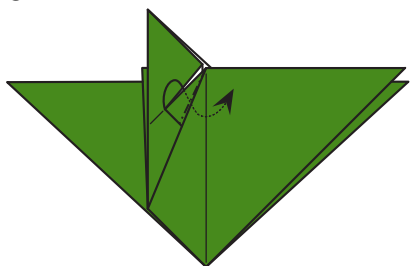

内翻折

14

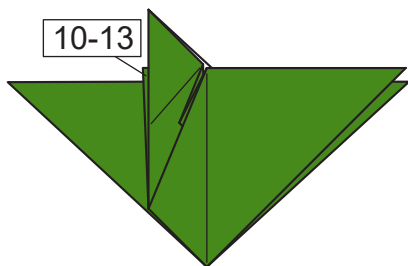

对侧重复步骤10-13

15

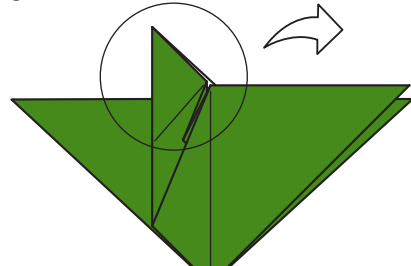

视图局部放大

16

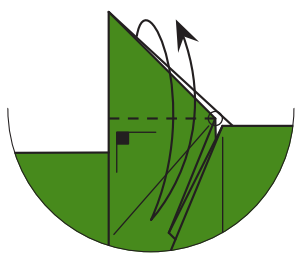

17

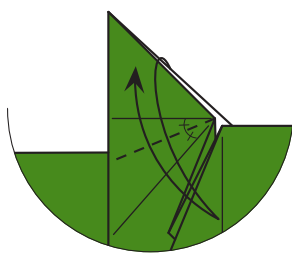

18

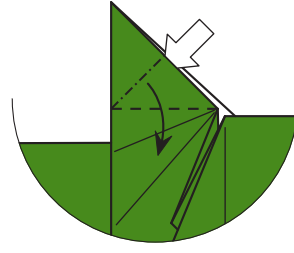

打开压平

19



20



两侧内翻折

21



22

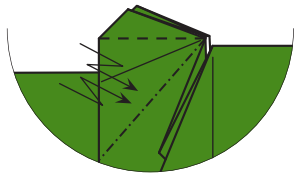

双向段折

23

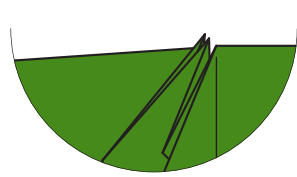

视图复原

24

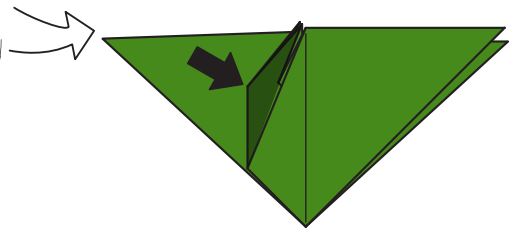

开放沉折

25

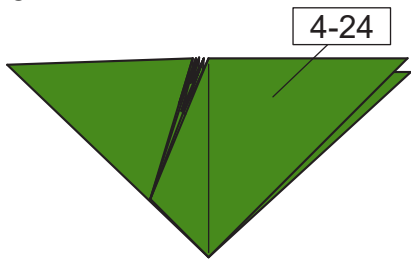

右侧重复步骤4-24

26

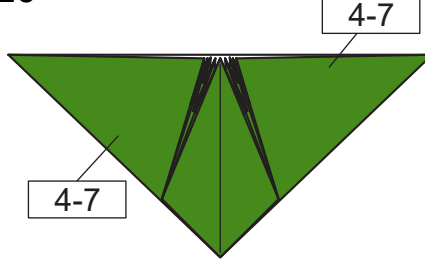

后侧重复步骤4-7

27

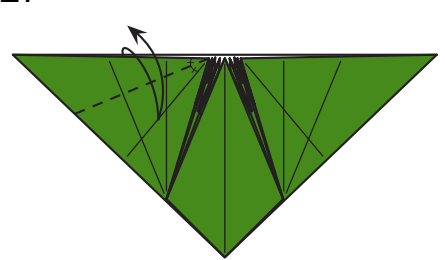

28

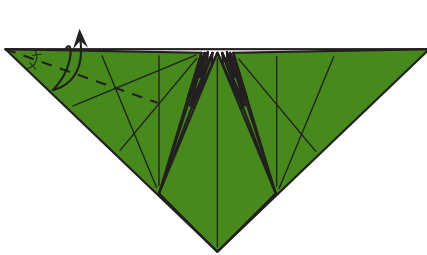

29

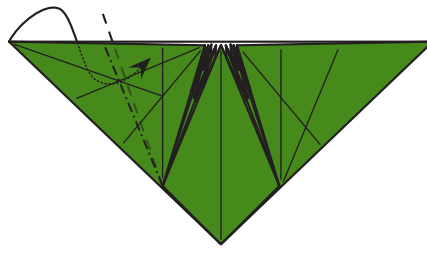

内翻折

30

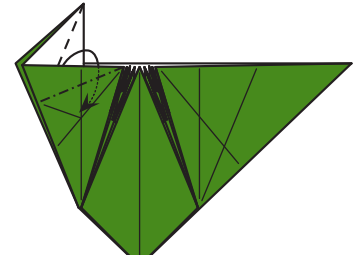

旋转折叠

31

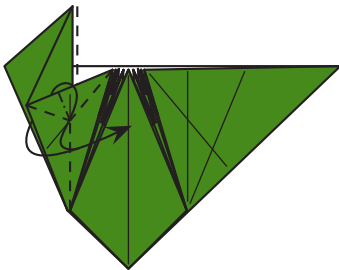

兔耳折

32

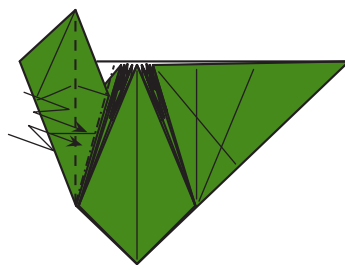

双向段折

33

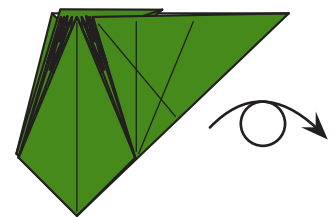

翻面

34

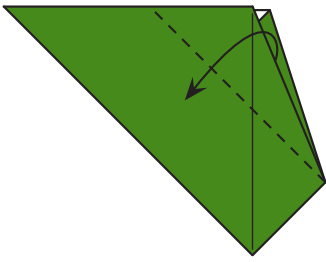

35

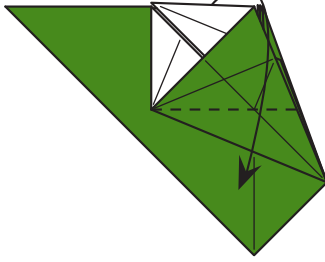

向下打开，不压平

36

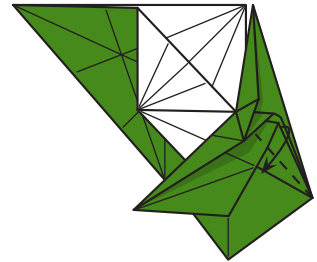

37

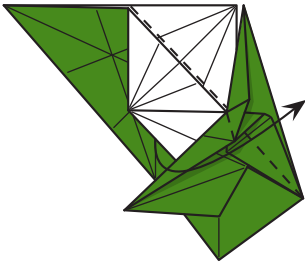

38

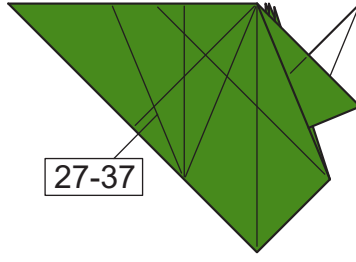

左侧重复步骤27-37

39

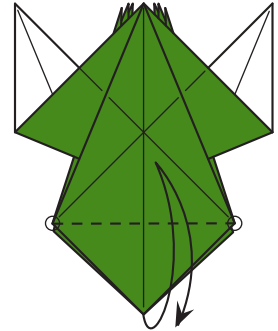

40

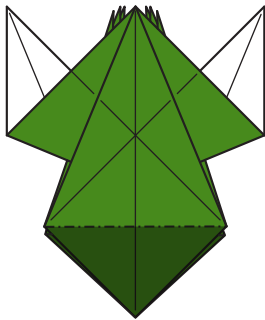

开放沉折

41

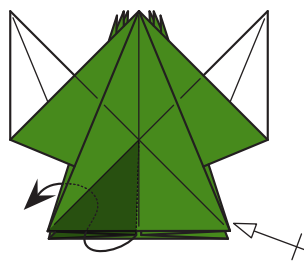

两边内翻折

42

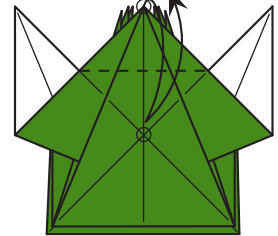

43

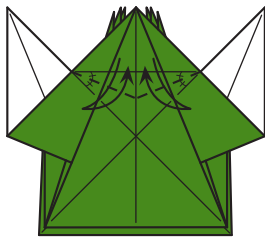

44

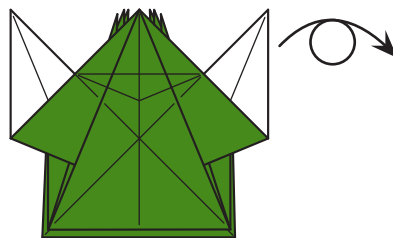

45

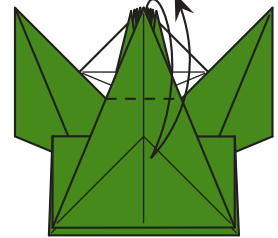



46

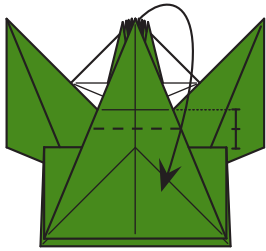

47

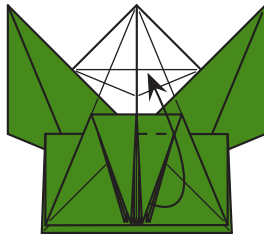

向上折一片

48

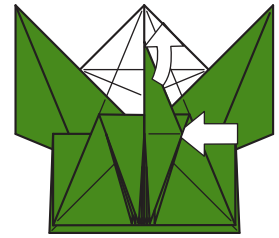

向上拉开

49

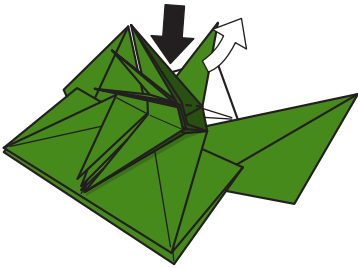

向下压平

50

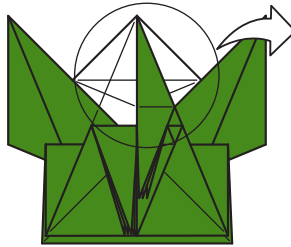

视图局部放大

51

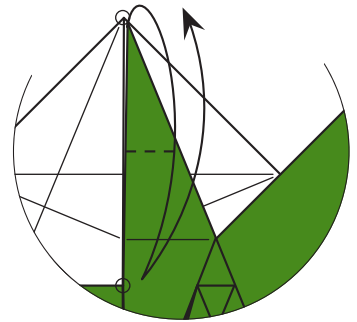

52

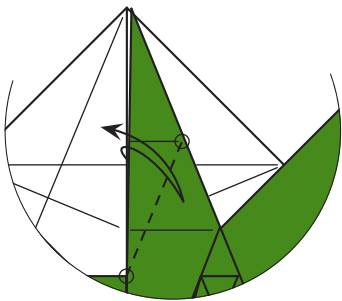

53

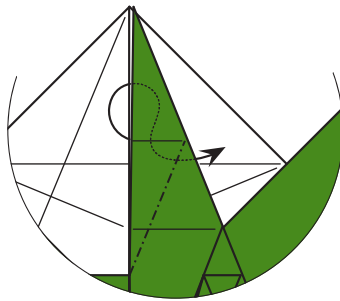

54

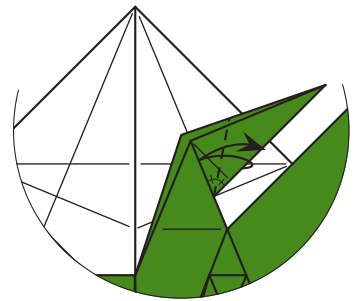

55

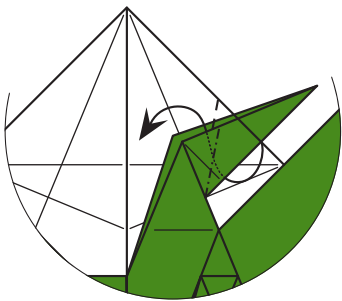

内翻折

56

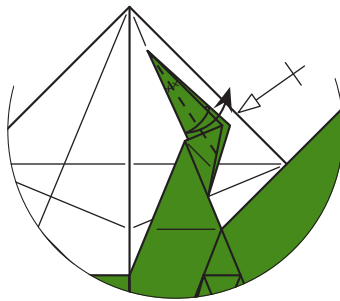

57

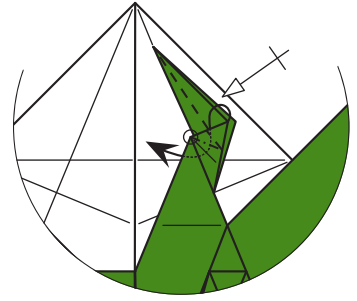

向内旋转折

58

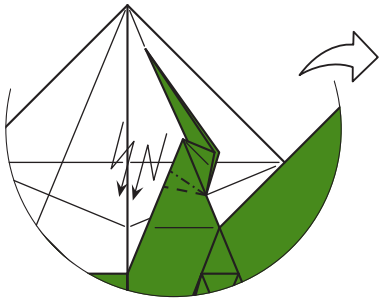

59

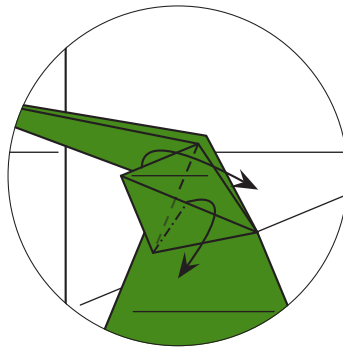

向右旋转打开

60

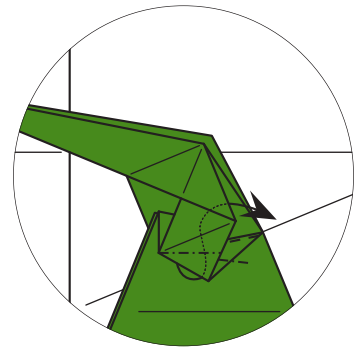

旋转折叠

61

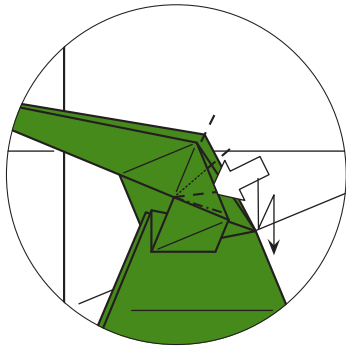

白色箭头处打开，  
向下旋转段折

62

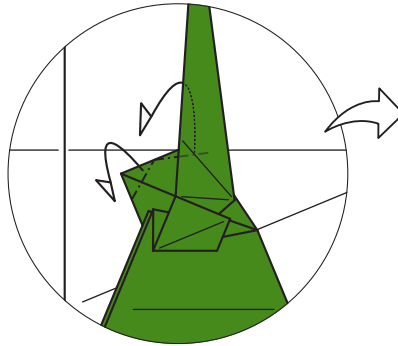

63

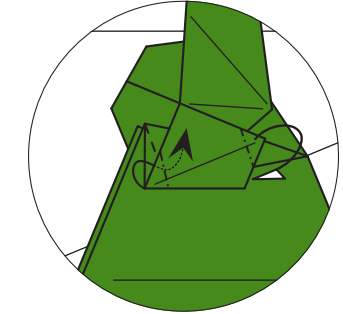

修出眼睛

64

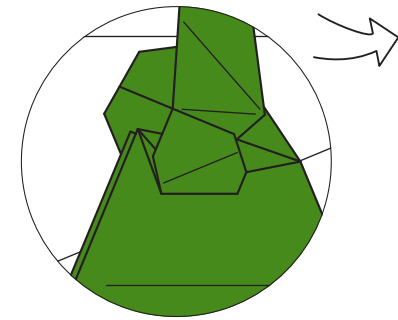

视图复原

65

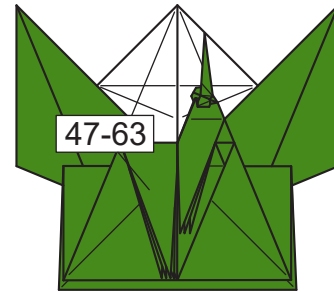

左侧重复步骤47-63

66

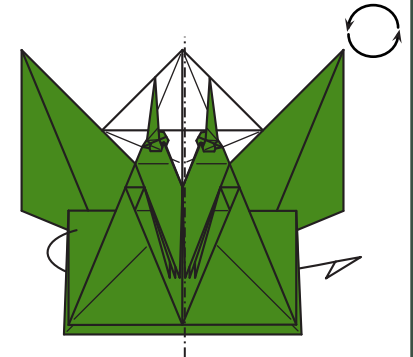

左侧向后对折，  
整体向左旋转

67

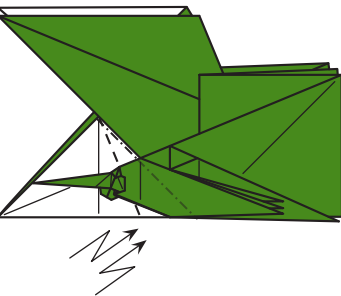

双向段折

68

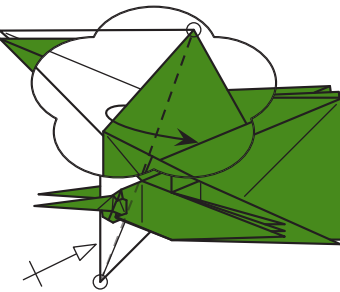

透视，连接两个点  
向内折叠，对侧重复

69

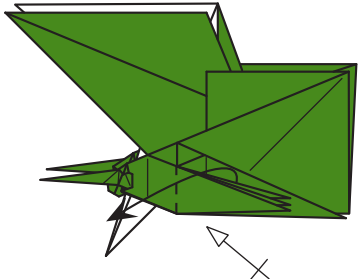

三层向左折叠，  
后侧重复

70

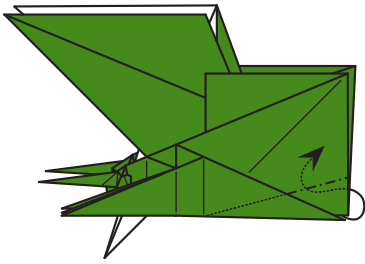

内翻折

71

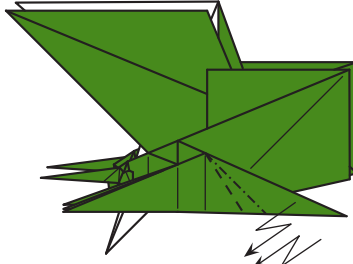

双向段折

72

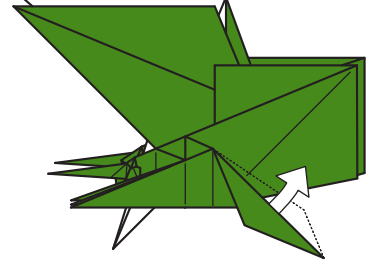

引出内侧纸层至虚线位置

73

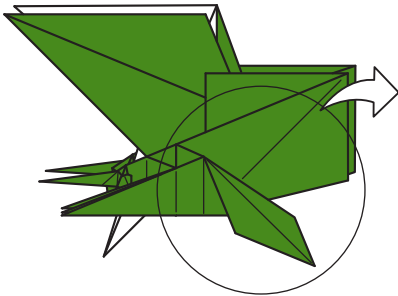

视图局部放大

74

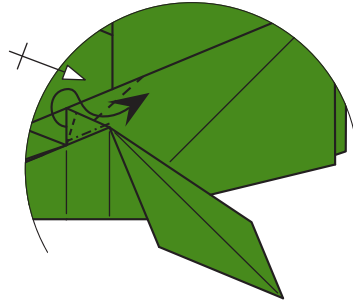

向内旋转折

75

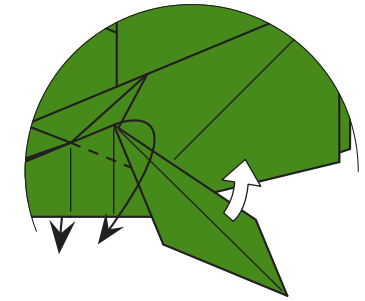

旋转

76

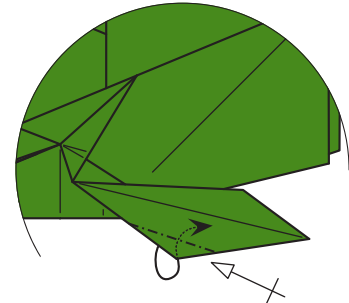

两侧内翻折

77

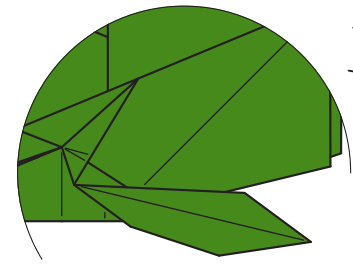

视图复原

78

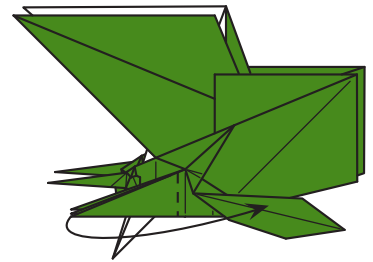

一片向右折

79

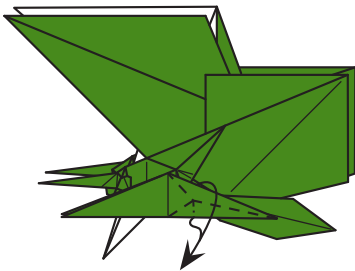

脚部兔耳折

80

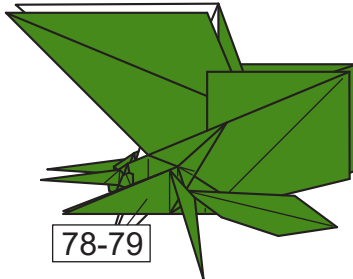

一层重复步骤78-79

81

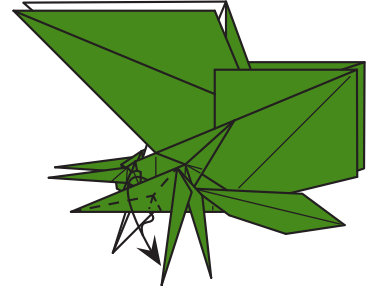

脚部兔耳折

82

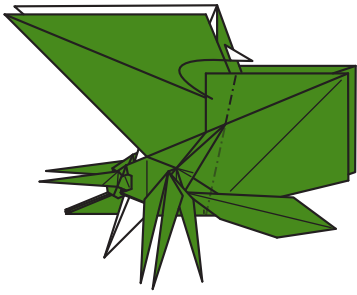

83

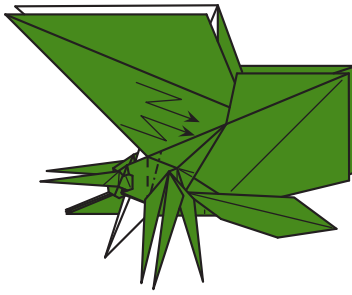

双向段折

84

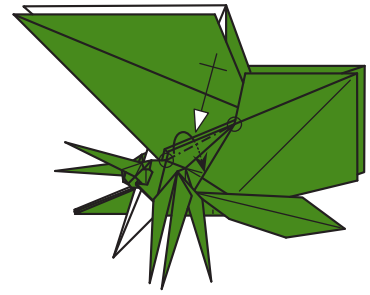

向内折，对侧重复

85

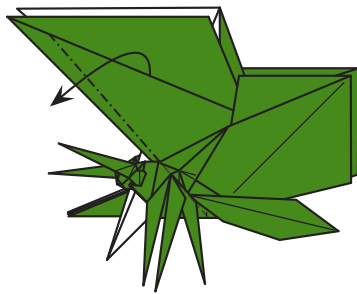

翅膀旋转出来一点

86

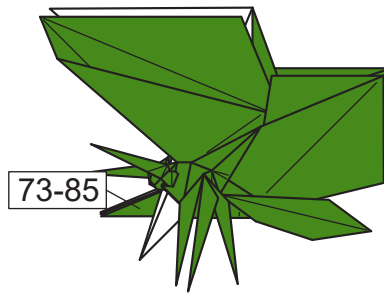

后侧重复步骤73-85

87

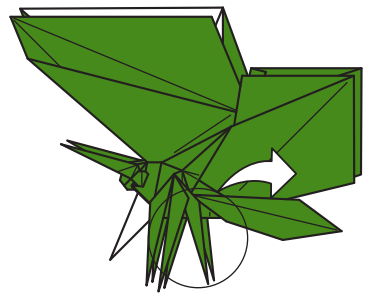

视图局部放大

88

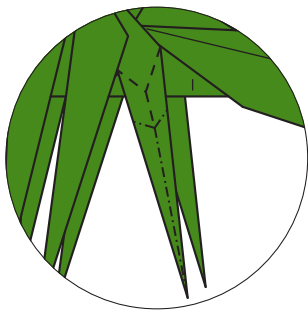

按照峰谷，脚部整形

89



做出昆虫脚部关节

90

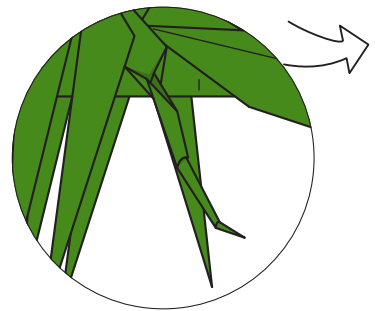

视图复原

91

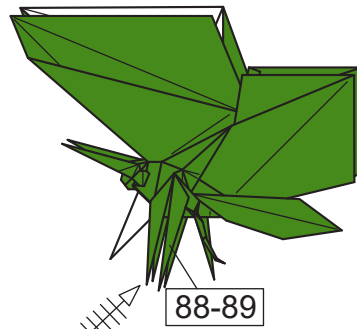

其余5只脚重复步骤88-89，  
触角和口器整形

92

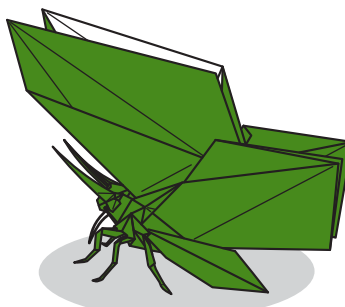

完成!



魔神

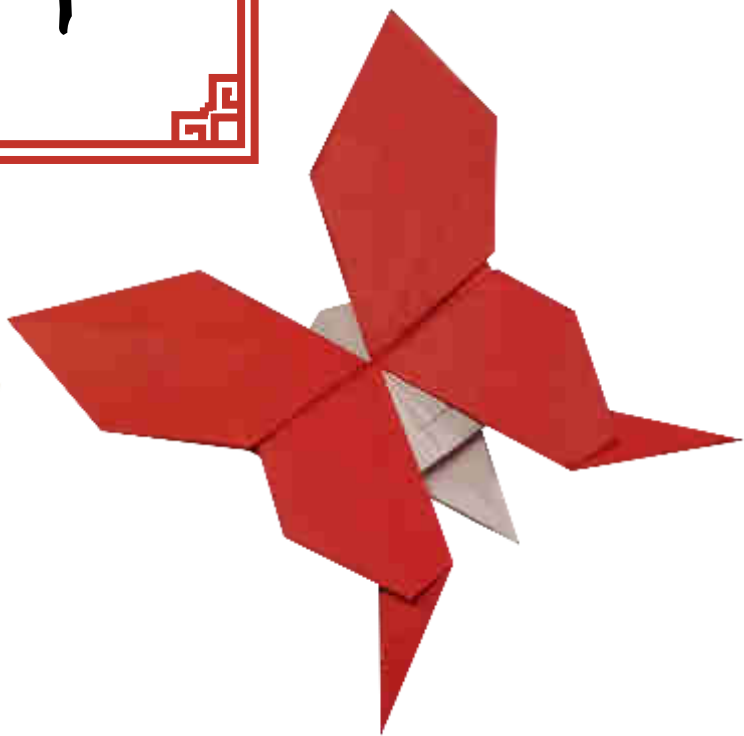
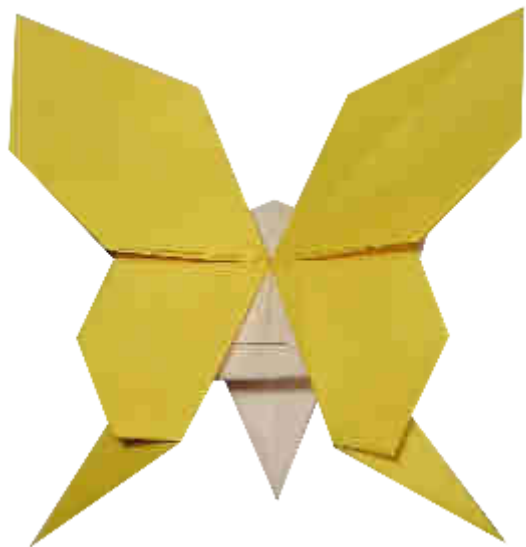

# 魔神

设计/Designer:张义帆 (港欧一家)  
 图示/Diagramer:徐涛 (逍遥丸子)

推荐用纸/Paper :  
 - 教育折纸 15x15 cm

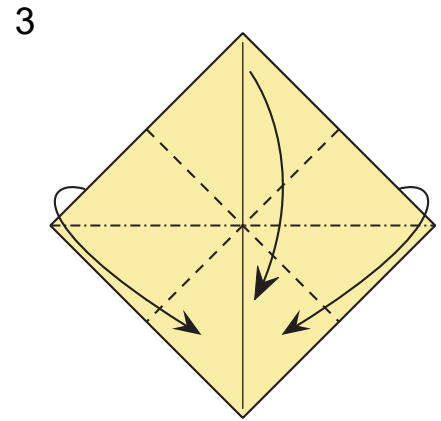
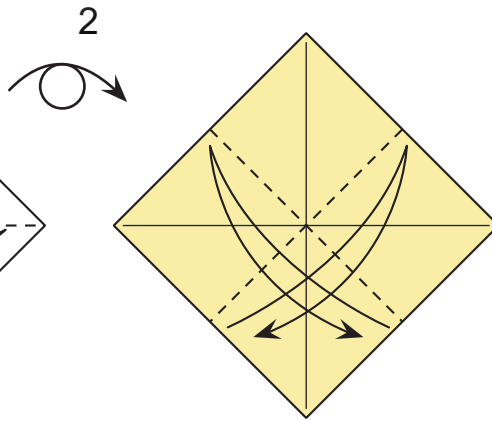
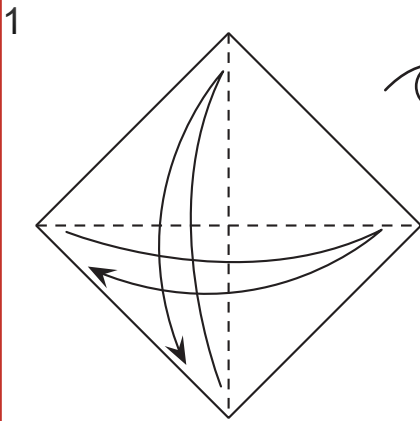
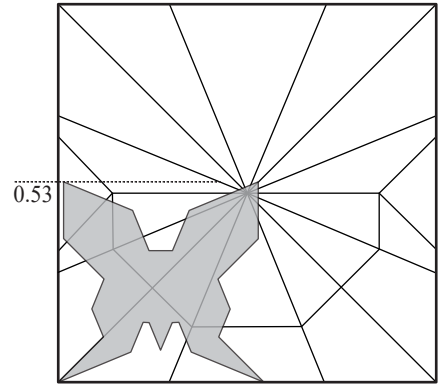
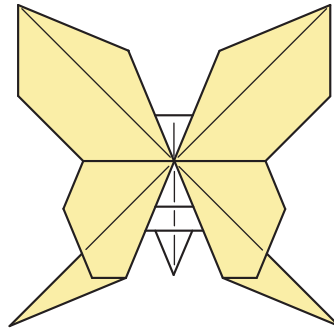

双正方形

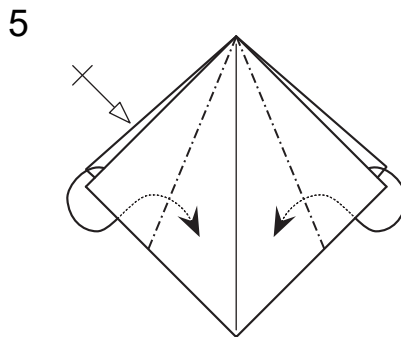
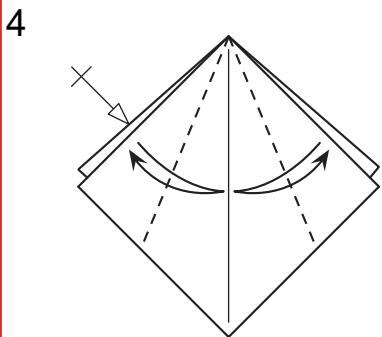

内翻折, 对侧重复

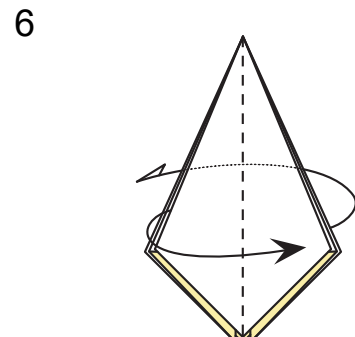

前后各旋转一层

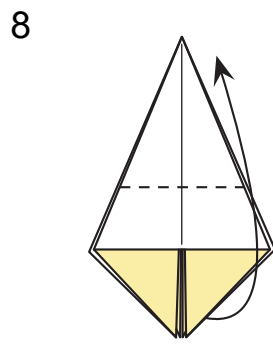
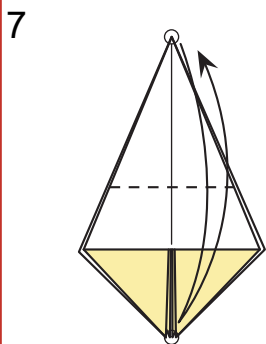

打开

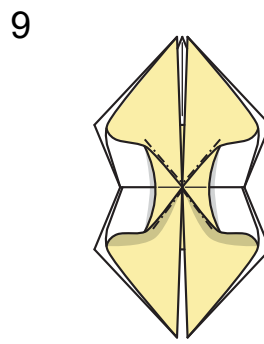

压平

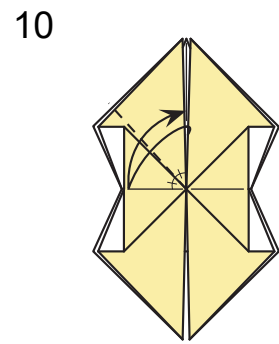

11

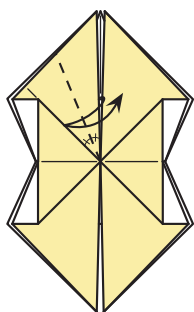

12

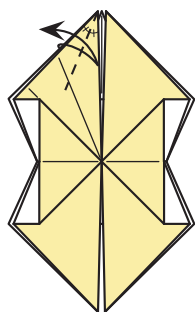

13

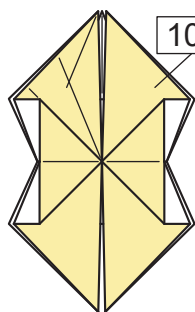

10-12

14

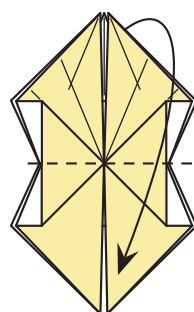

右侧重复步骤10-12

15

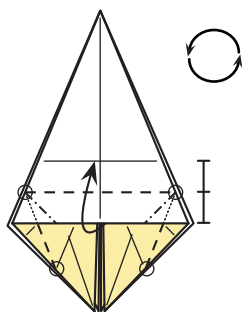

16

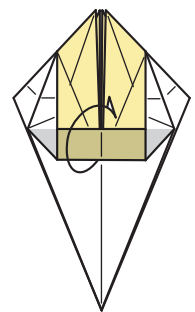

调整阴影层至后层

17

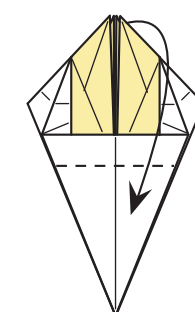

18

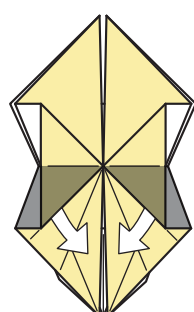

调整阴影处纸层

19

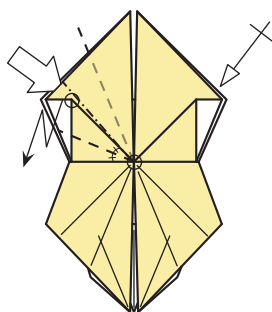

打开，旋转段折，  
右侧重复

20

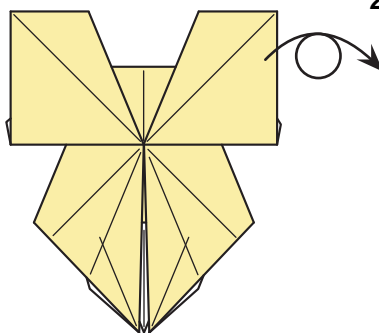

21

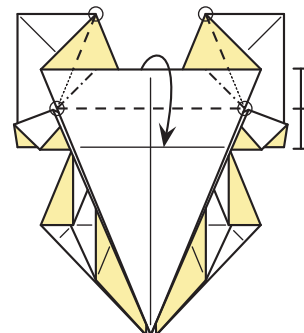

向下旋转折

22

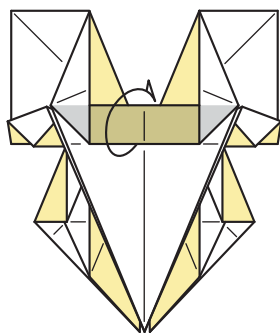

调整阴影层至后层

23

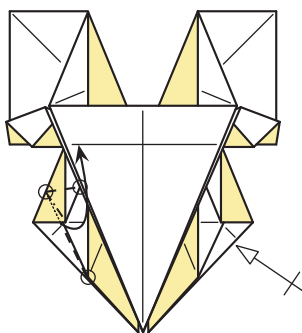

向上旋转折，右侧重复

24

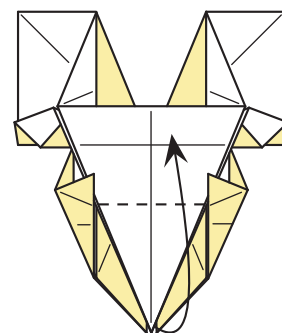



22

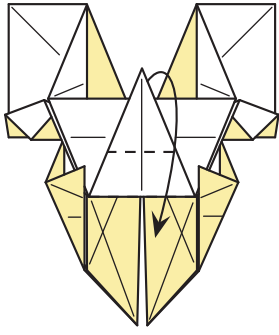

23

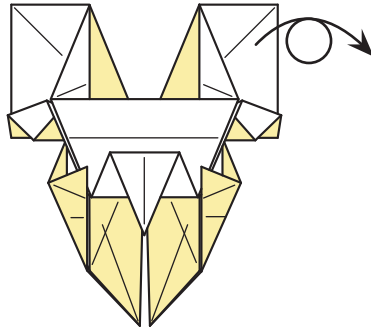

24

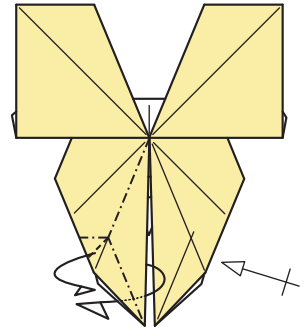

向左旋转折，右侧重复

28

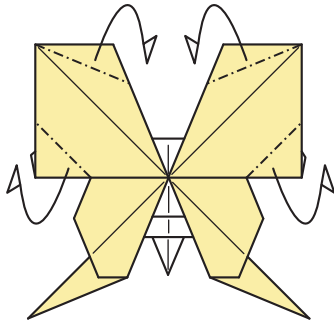

整形

29

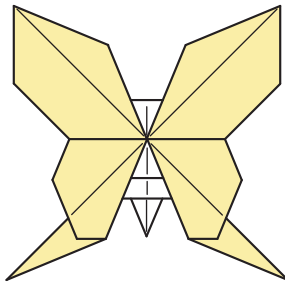

完成!



# 须臾

设计/Designer: 桑Q  
 图示/Diagramer: 桑Q

推荐用纸/Paper :  
 - 教育折纸 15x15 cm  
 - 棉箔纸 20x20 cm

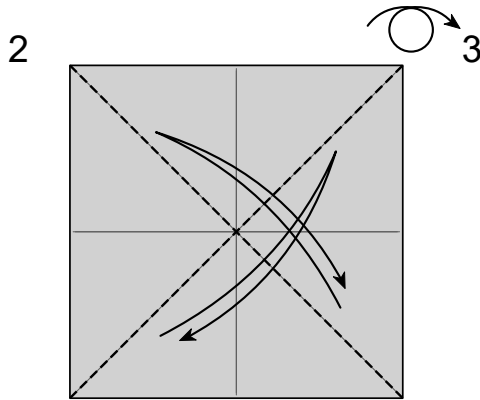
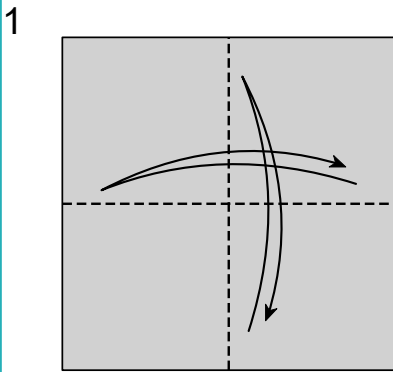
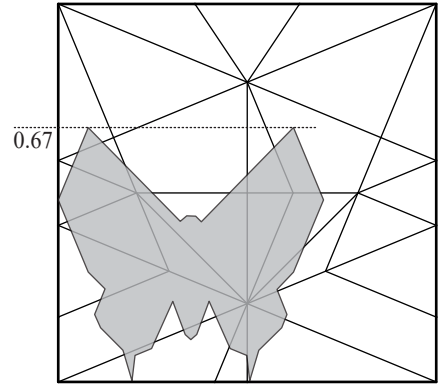
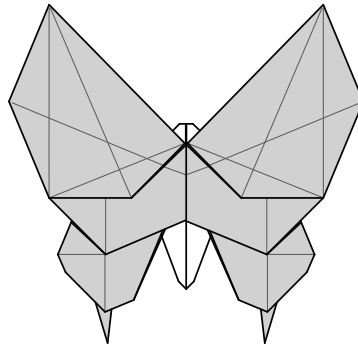

折出折痕，翻面

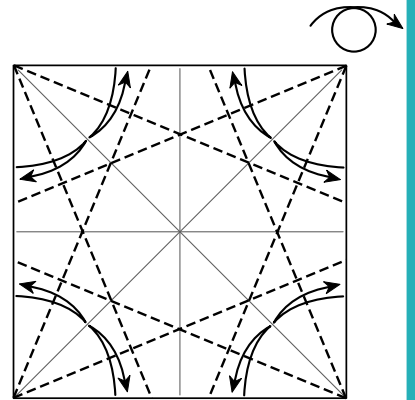

折出折痕，翻面

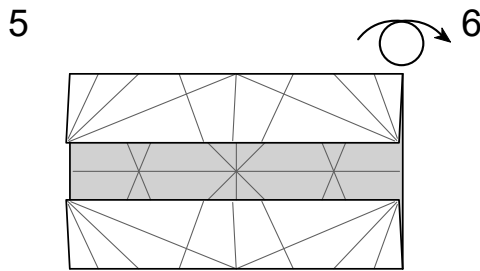
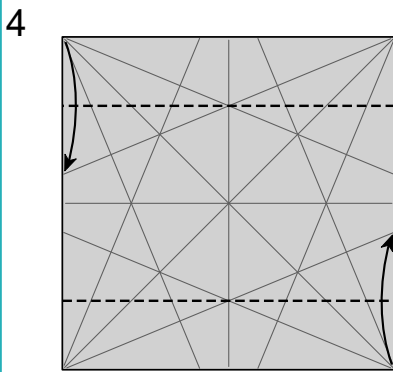

翻面

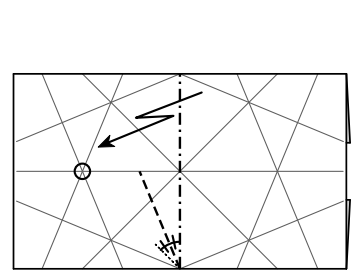

线对点旋转折叠

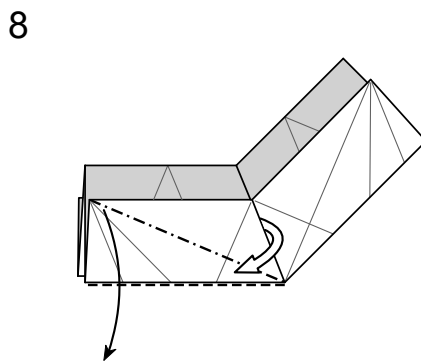
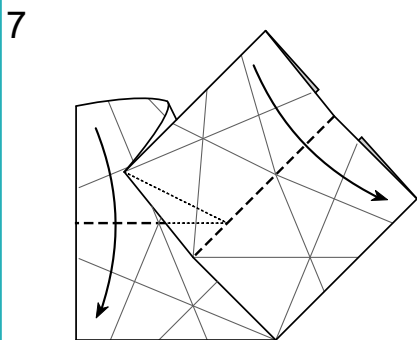

拉出内部纸层

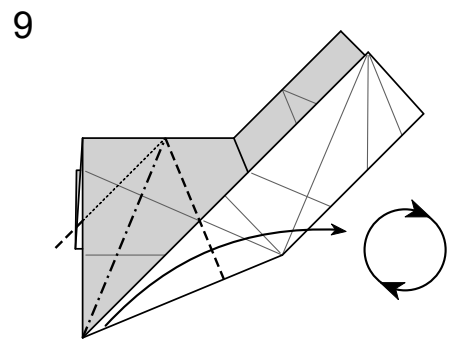

旋转段折

10

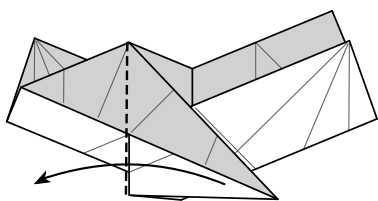

11

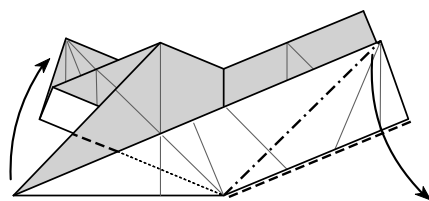

旋转折叠

12

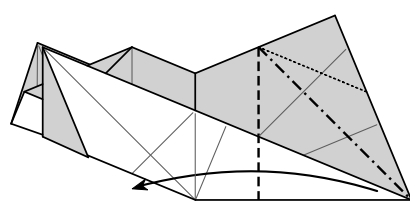

向左旋转段折压平

13

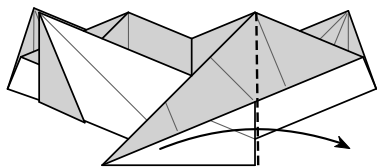

14

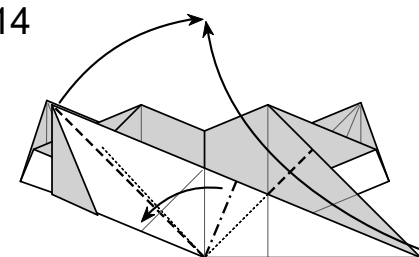

左右两个分支向中间折

15

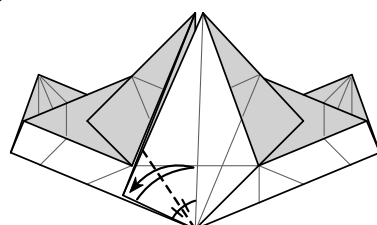

16

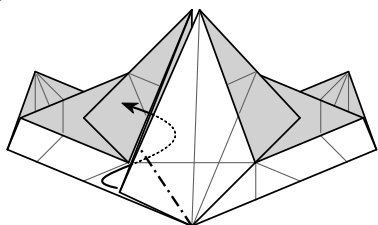

内翻折

17

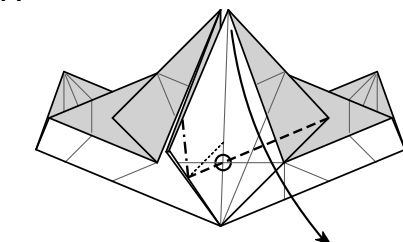

一片向下折，连接处压平

18

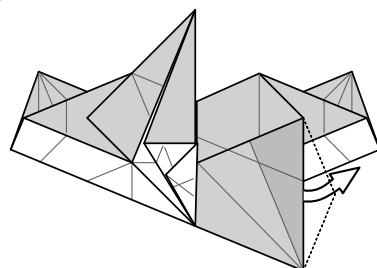

引出内部纸层

19

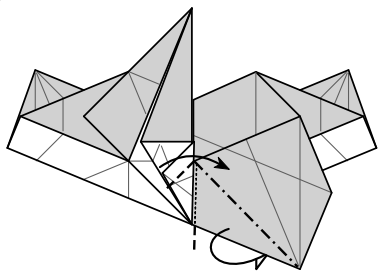

向后旋转折，白色块向右压平

20

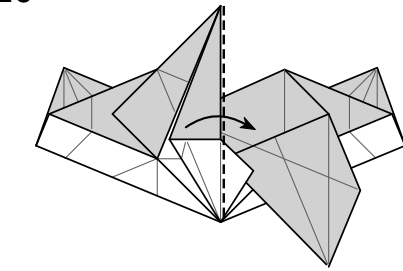

21

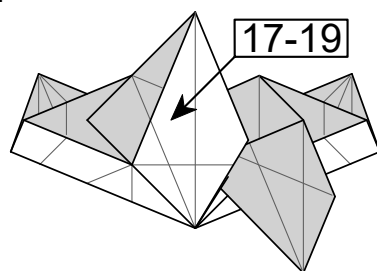

左侧重复步骤17-19

22

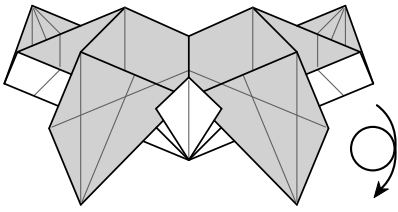

翻面并旋转180°

23

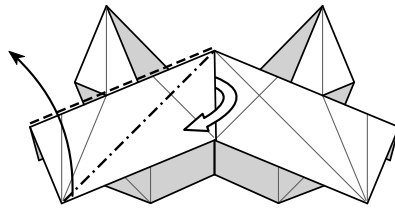

拉出内部纸层

24

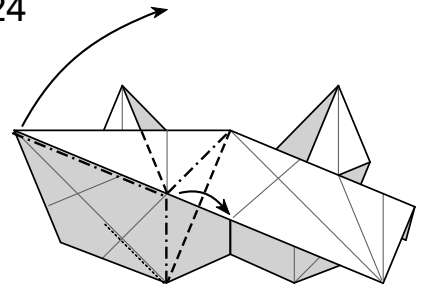

按峰谷压平，注意虚线位置

25

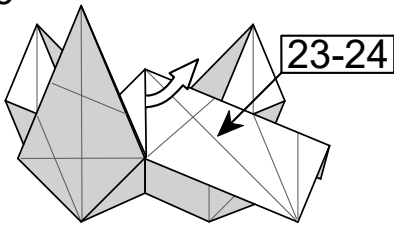

右侧重复步骤23-24

26

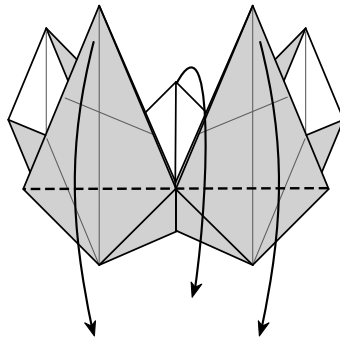

向下折叠

27

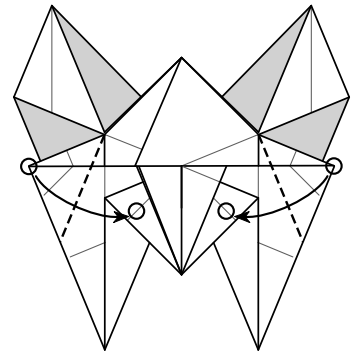

28

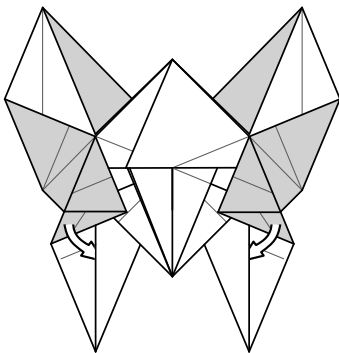

引入下方纸层内

29

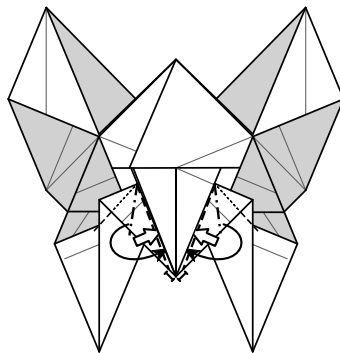

向内旋转段折，注意留一点距离

30

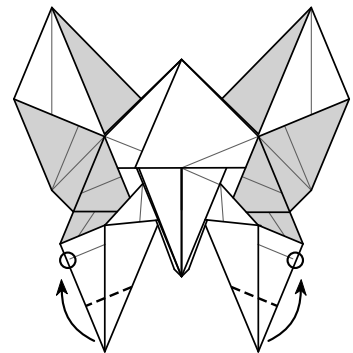

31

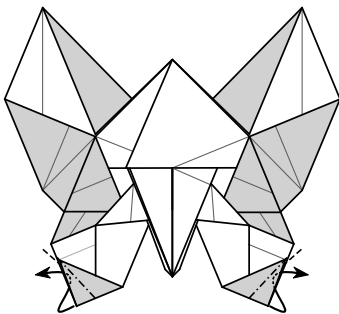

左右内翻折

32

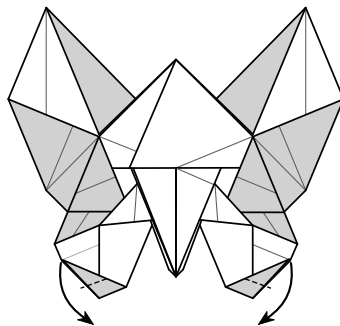

33

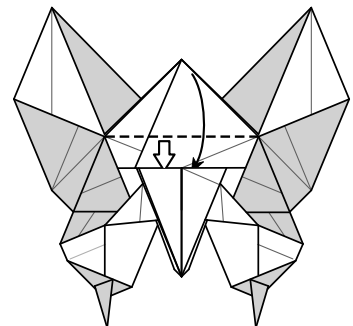

一片旋转，藏进内部

34

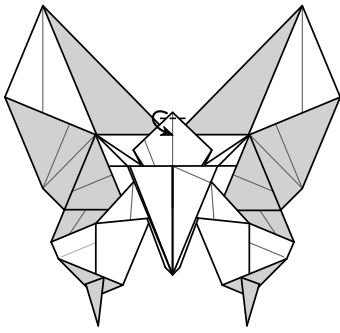

翻面并旋转180°

35

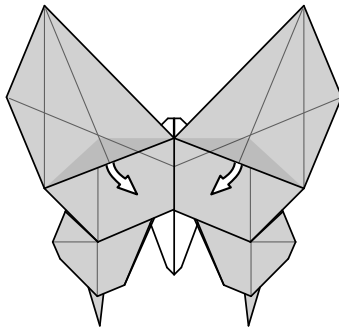

可选步骤：引出内部纸层

36

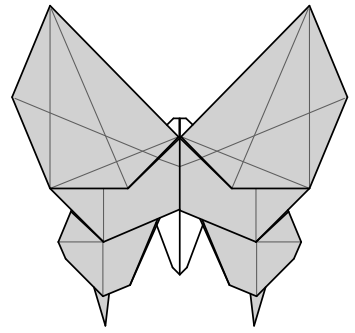

37

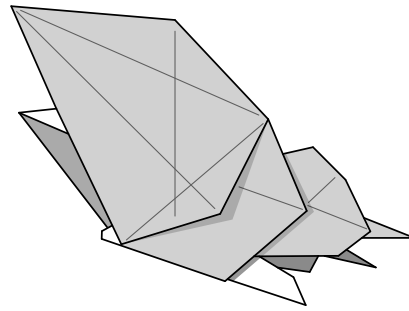
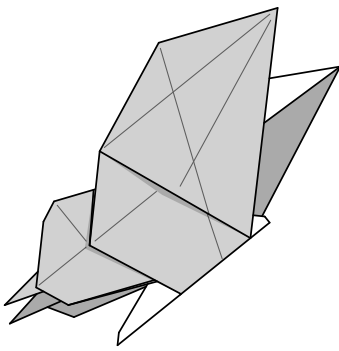

完成!



春光

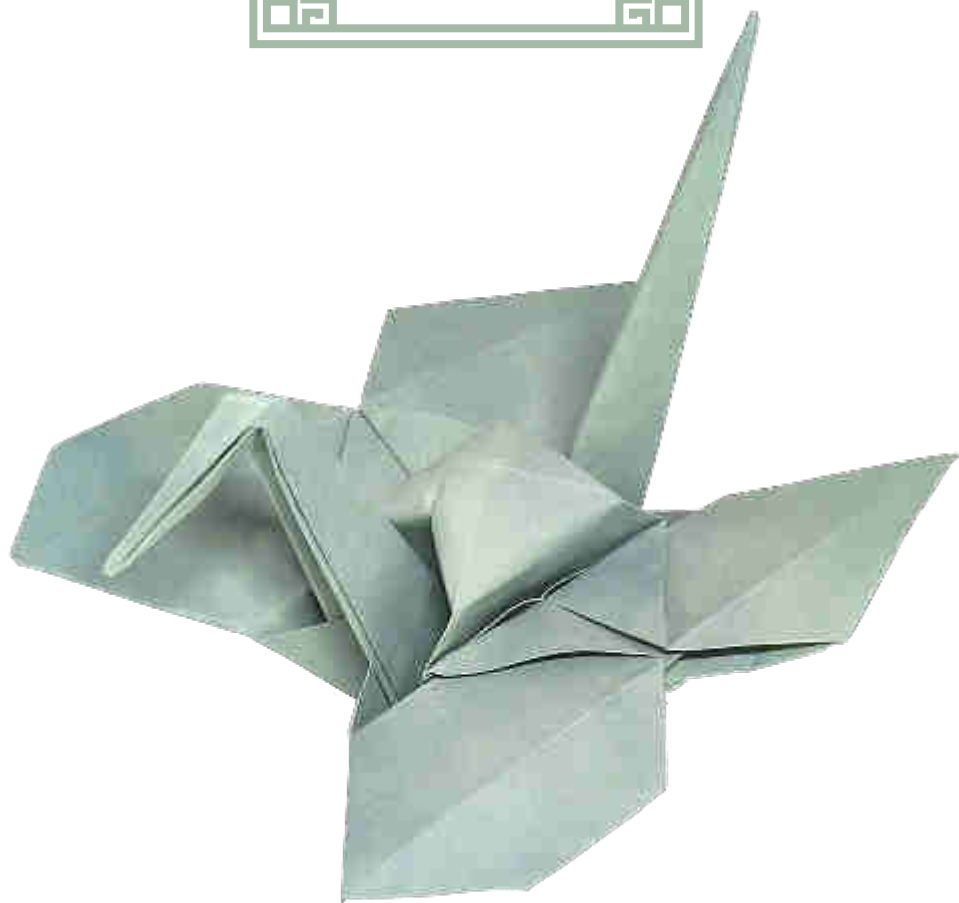



# 春光

设计/Designer: 孟伟凝 (212Moving)  
 图示/Diagramer: 孟伟凝 (212Moving)

推荐用纸/Paper :  
 - 教育折纸 15x15 cm  
 - Biotope 20x20 cm

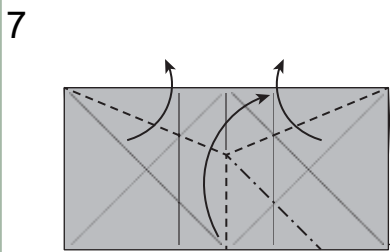
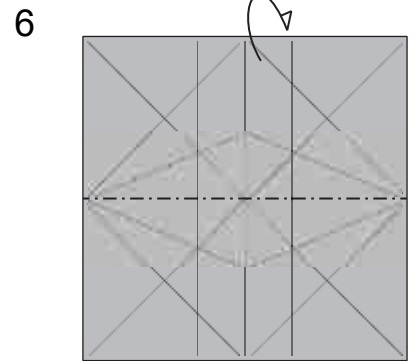
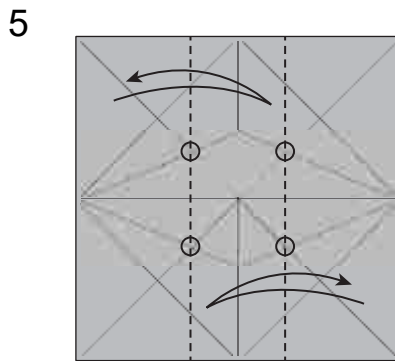
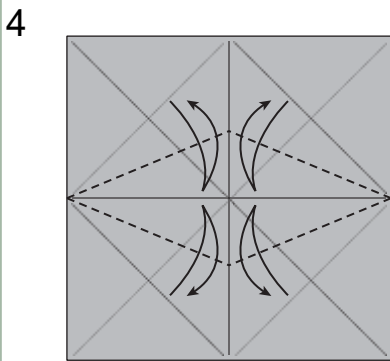
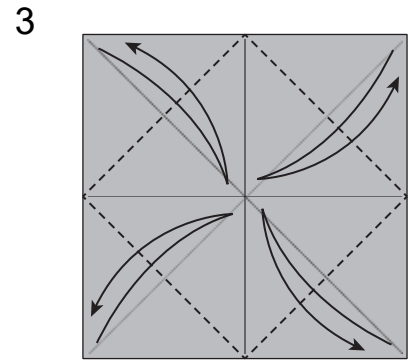
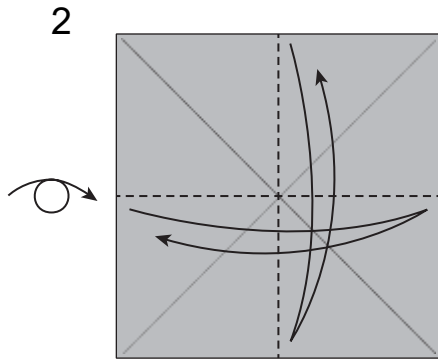
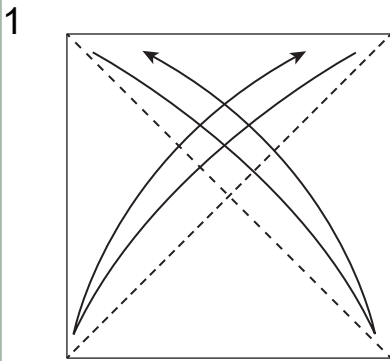
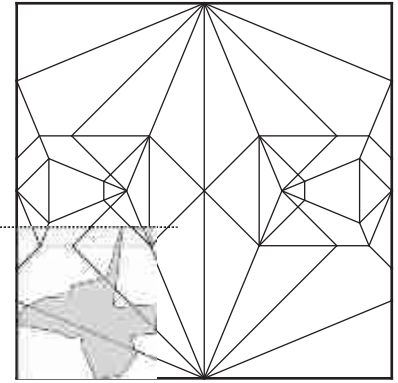
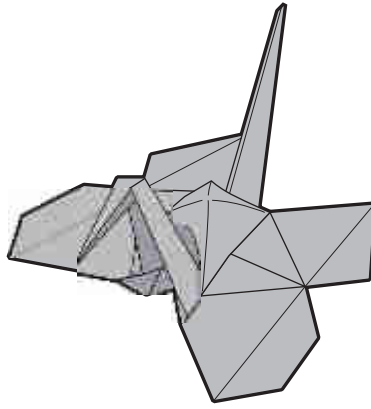

前面一层兔耳折

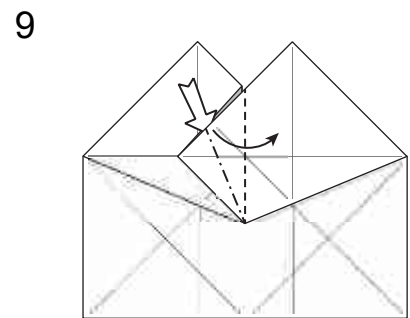
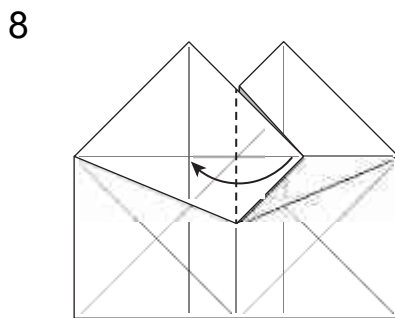

打开压平

10

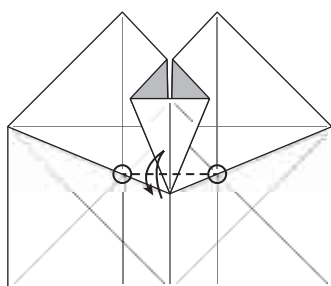

11

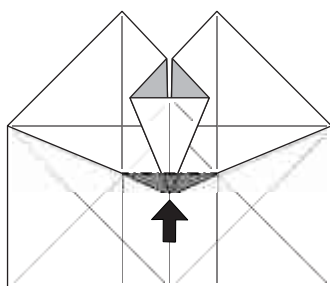

开放沉折

12

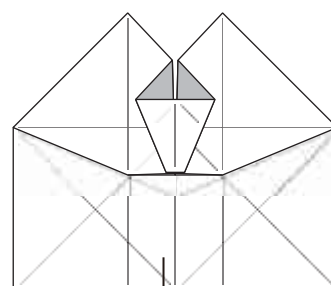

7-11  
后侧重复步骤7-11

13

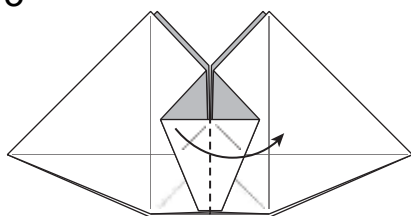

14

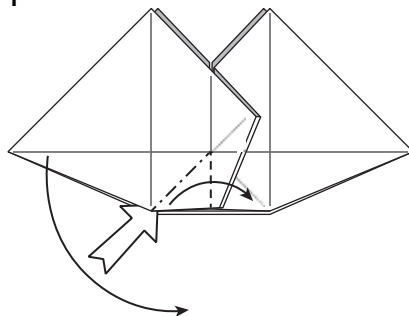

打开段折, 再压平

15

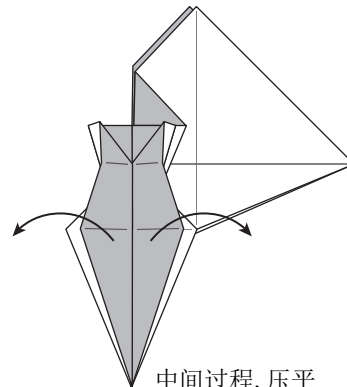

中间过程, 压平

16

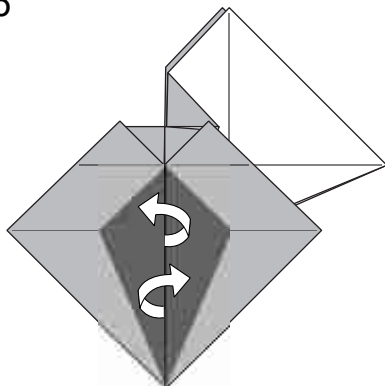

引出内部纸层

17

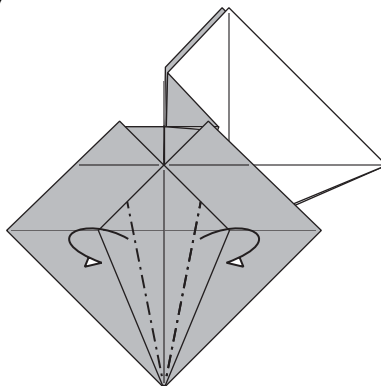

18

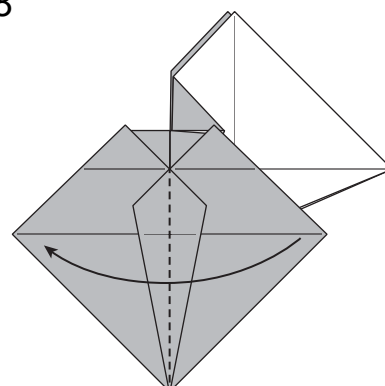

19

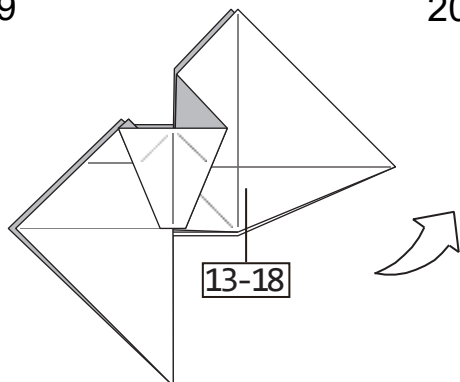

右侧重复步骤13-18

20

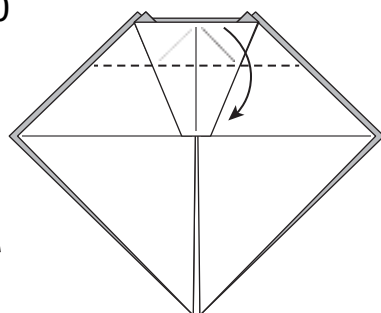

21

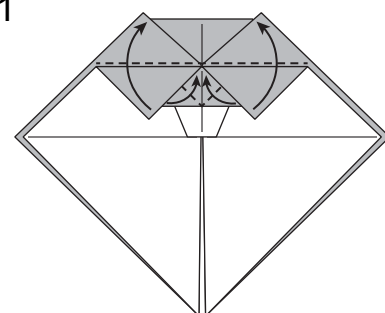

向上折的过程, 参考步骤22

22

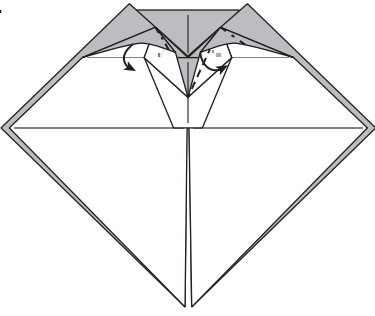

注意左右不一样

23

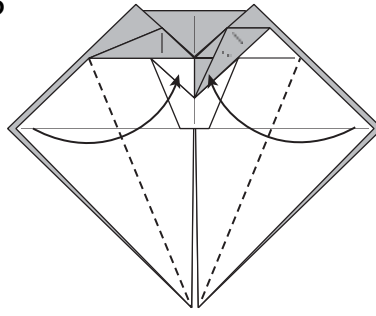

24

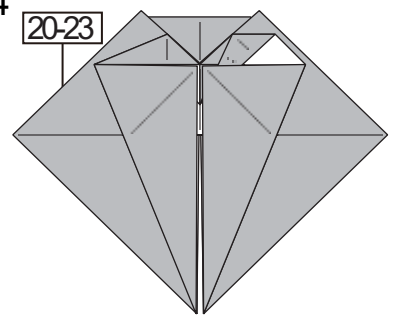

后侧重复步骤20-23

25

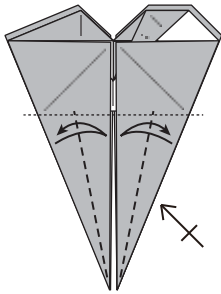

26

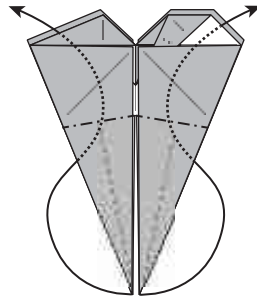

27

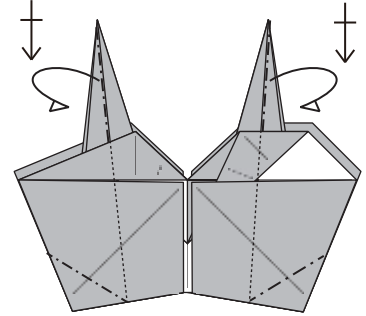

两侧向内旋转折，后侧重复

28

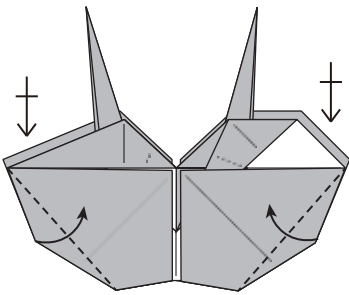

29

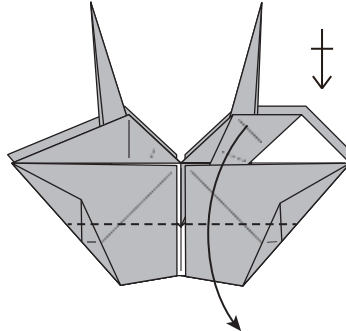

30

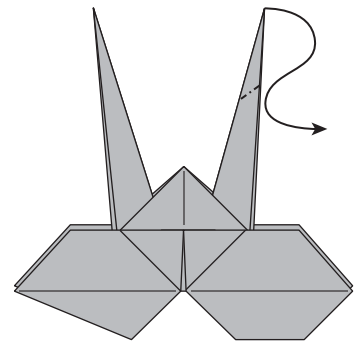

31

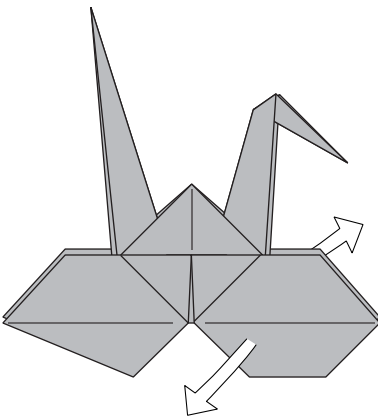

拉开立体化

32

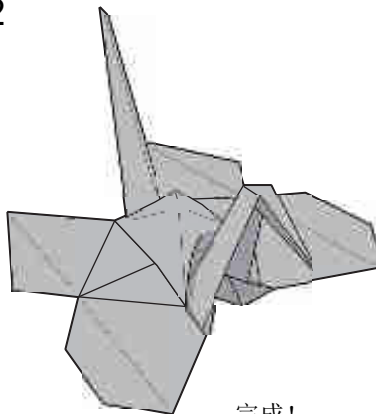

完成!

避  
寒



# 避寒

设计/Designer:St  
 图示/Diagramer:St

推荐用纸/Paper :  
 - 教育折纸 35x35 cm  
 - Hanji 30x30 cm

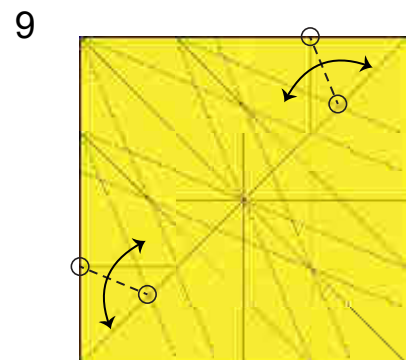
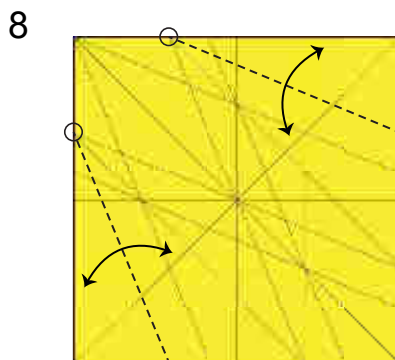
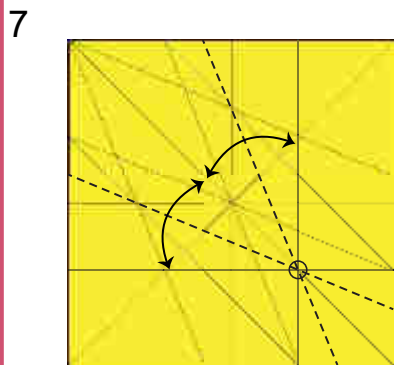
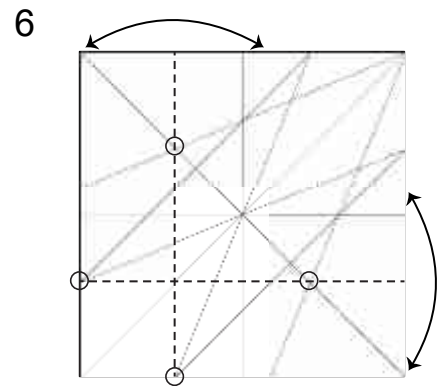
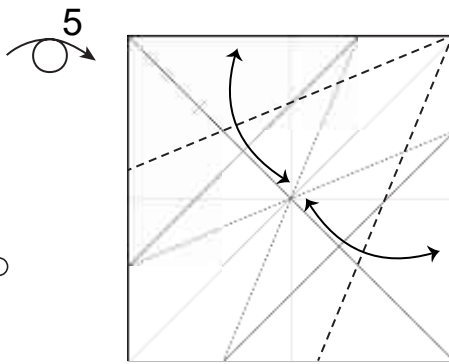
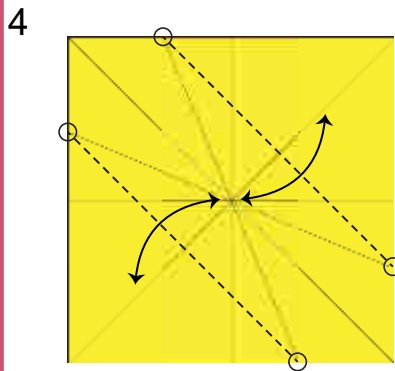
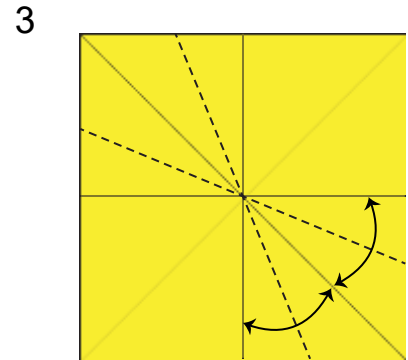
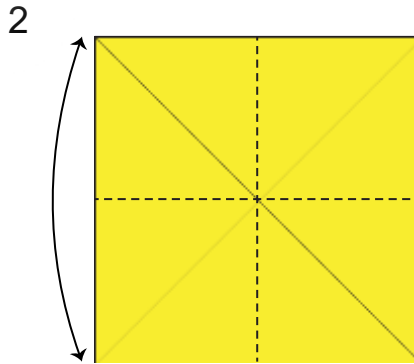
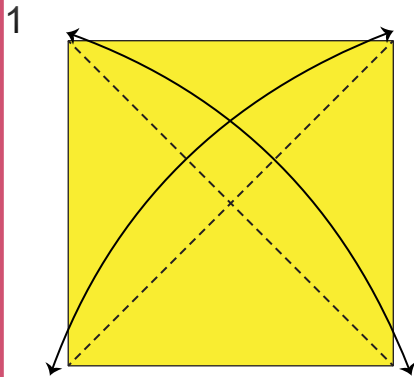
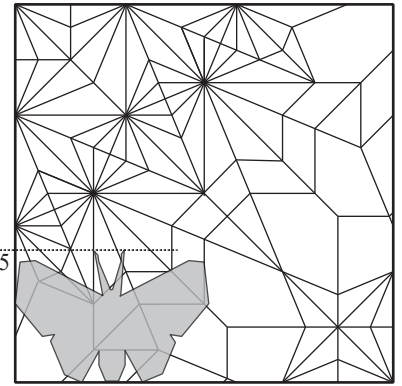
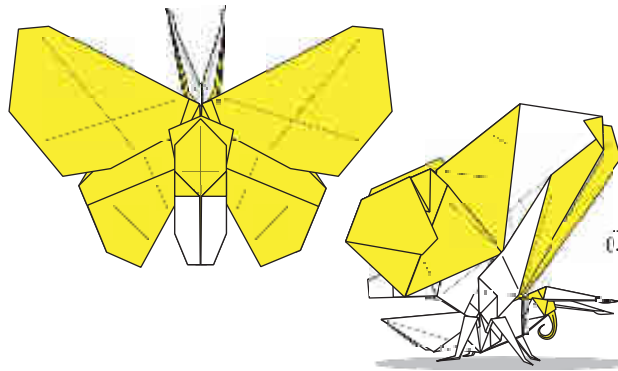

10

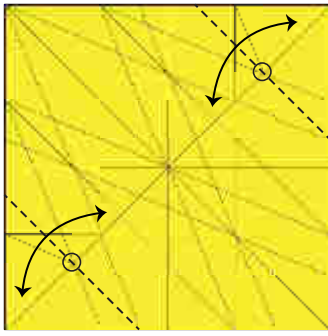

11

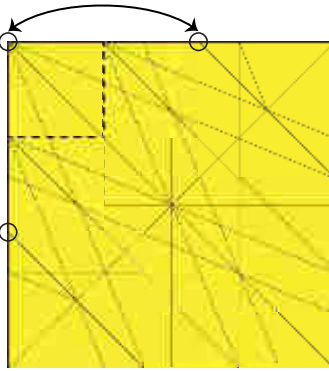

12

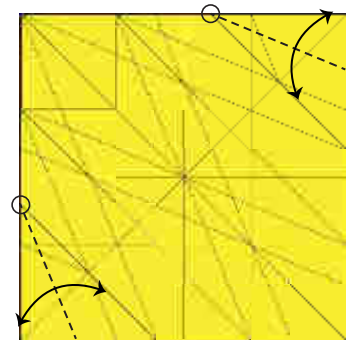

13

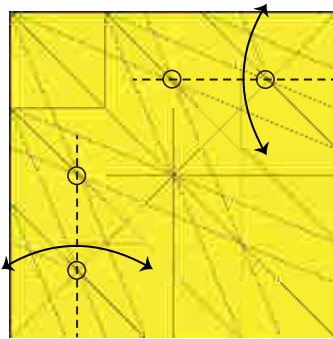

14



15

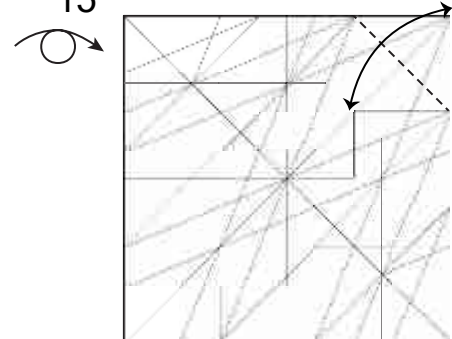

16

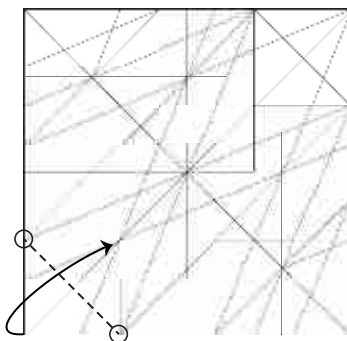

17

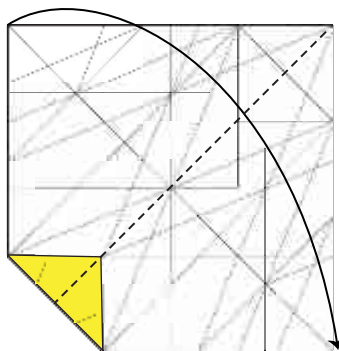

18

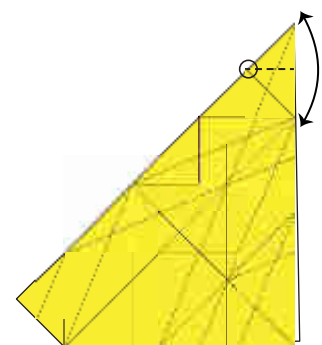

19

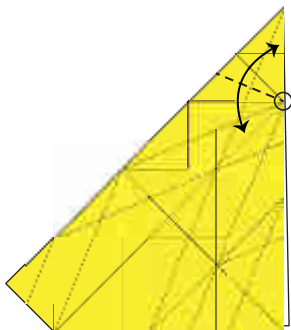

20

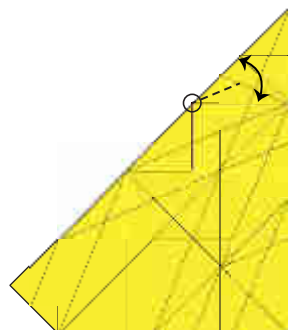

21

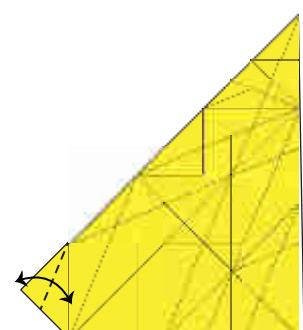

22



折出折痕后，完全打开

23

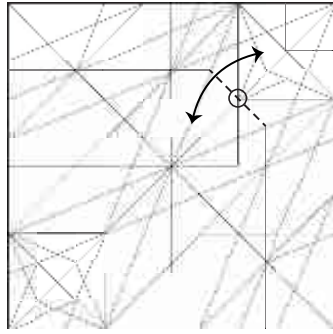

24

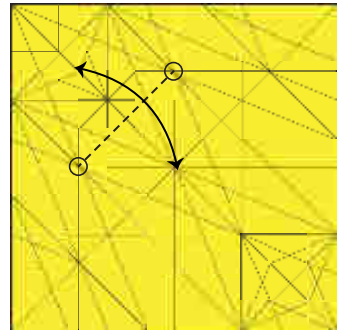

25

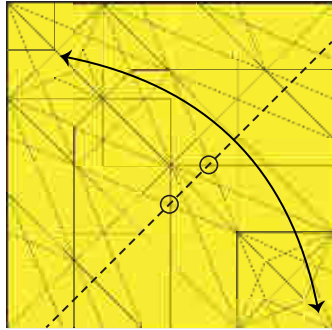

26

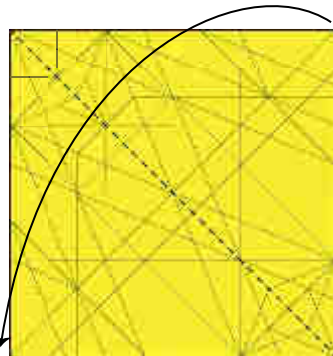

27

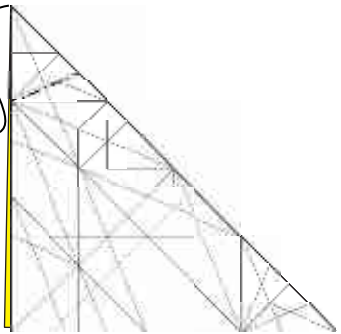

28

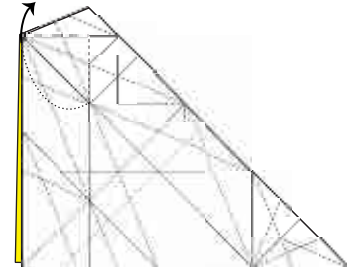

29

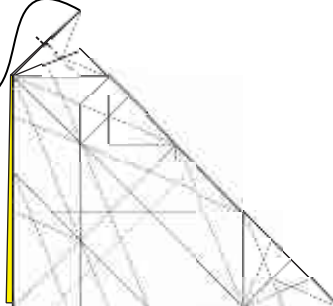

30

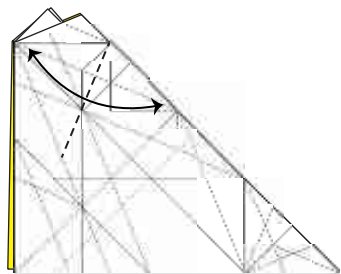

31

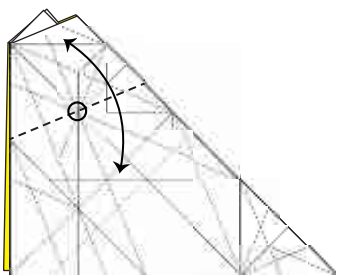

32

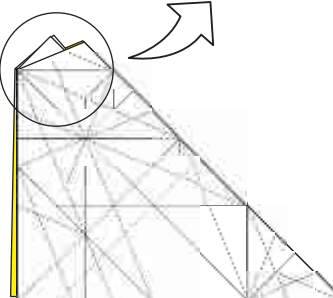

视图局部放大

33

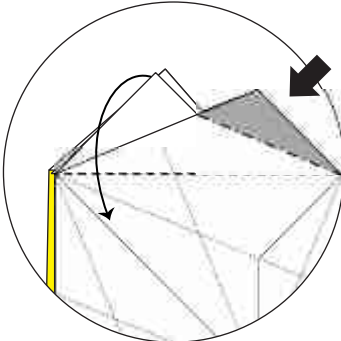

延展沉折



34

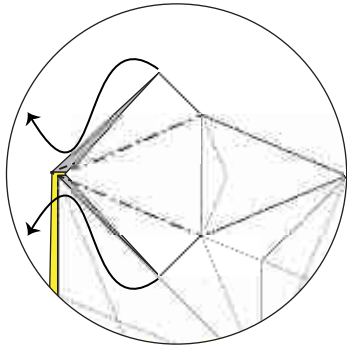

35

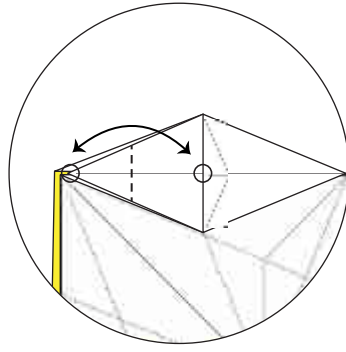

36

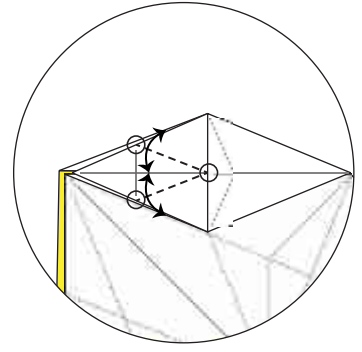

37

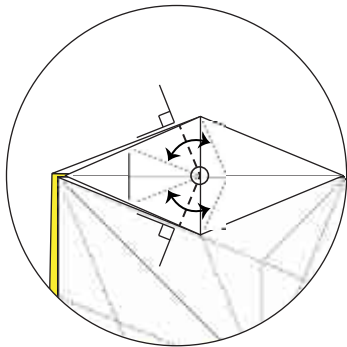

38

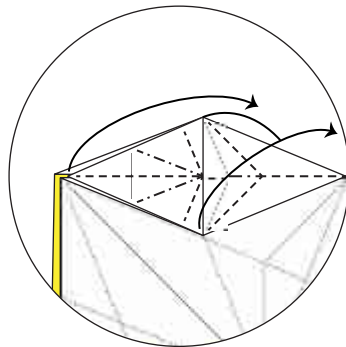

39

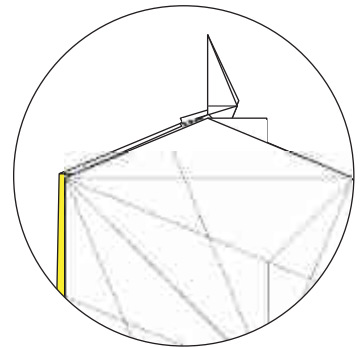

视图复原

40

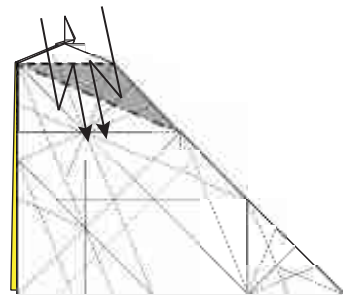

向内双向段折

41

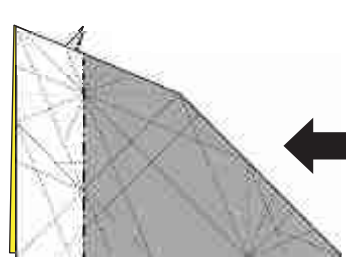

开放沉折

42

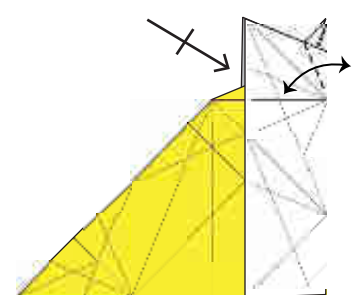

43

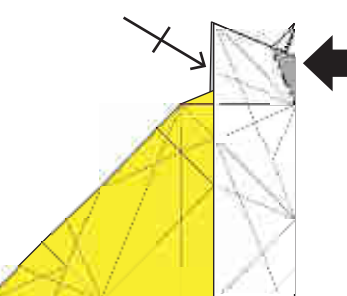

开放沉折

44

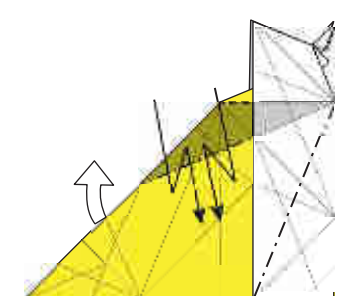

向上旋转折，  
阴影处向内段折

45

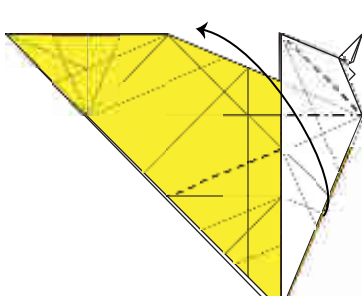



46

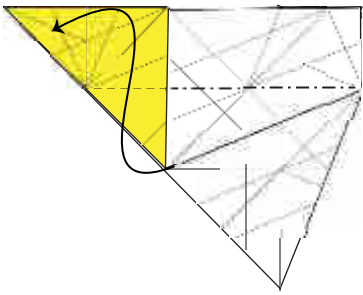

47

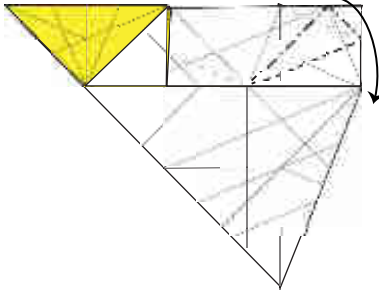

48

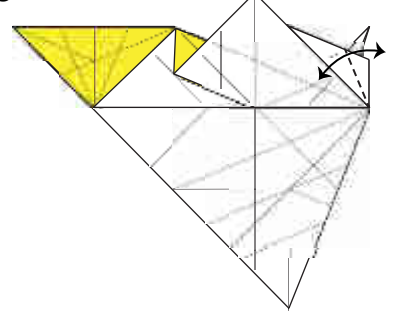

49

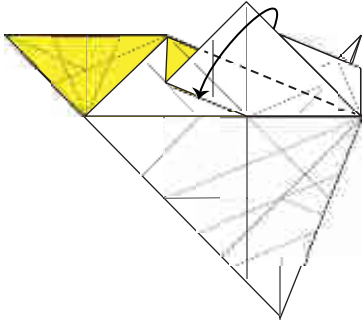

50

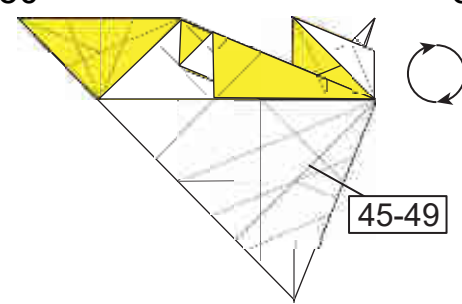

51

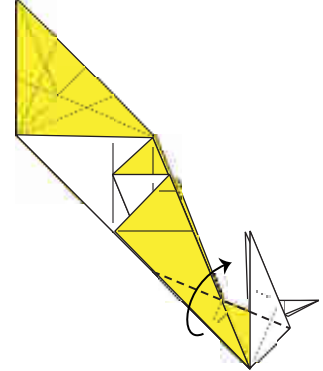

后侧重复步骤45-49

52

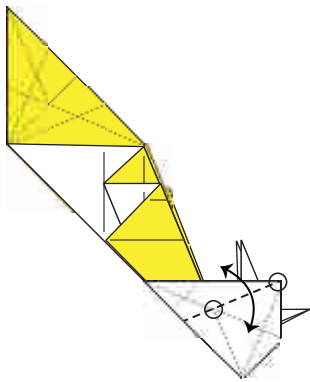

53

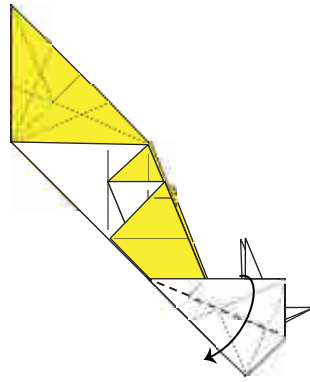

54

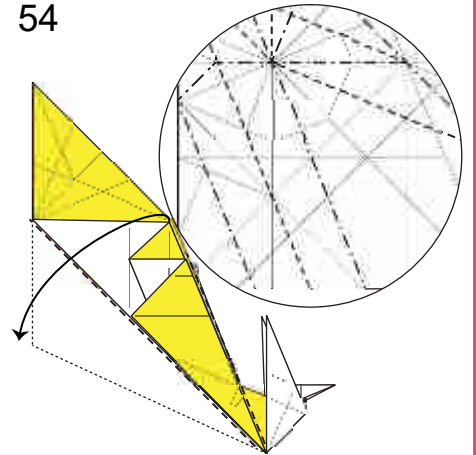

55

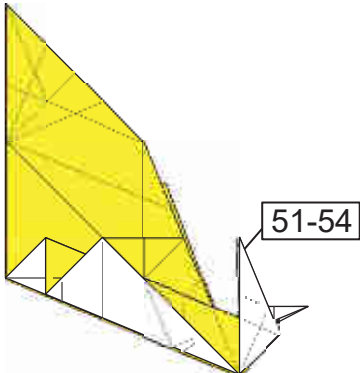

56

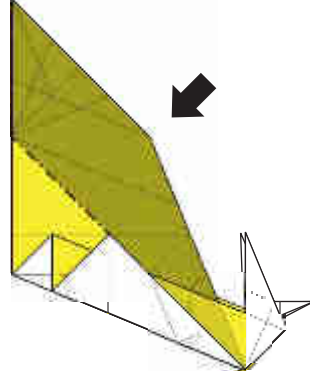

57

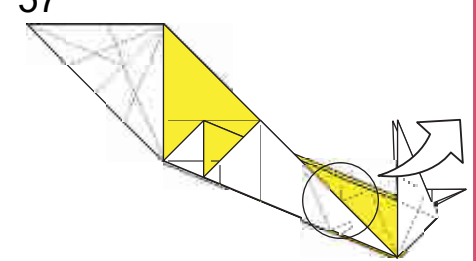

视图局部放大

后侧重复步骤51-54

开放沉折

58

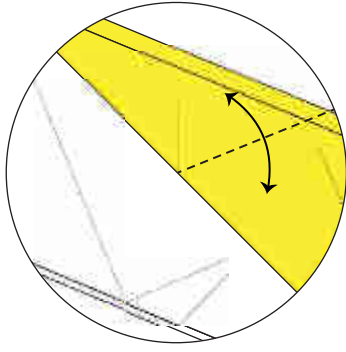

59

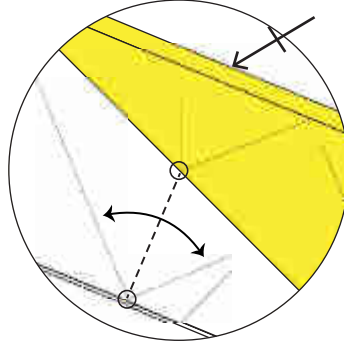

60

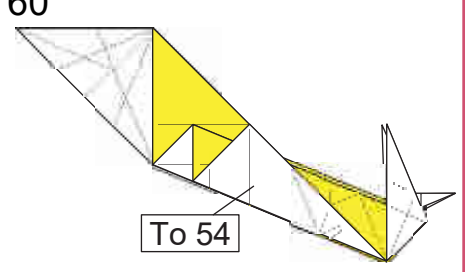

复原至步骤54

61

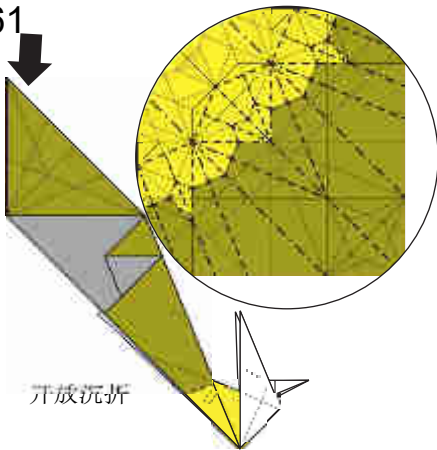

开放沉折

62

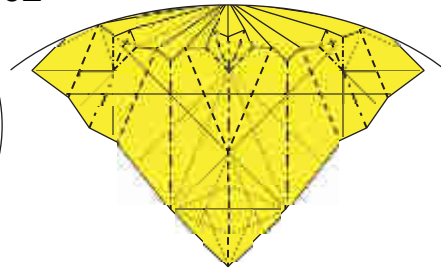

过程中

63

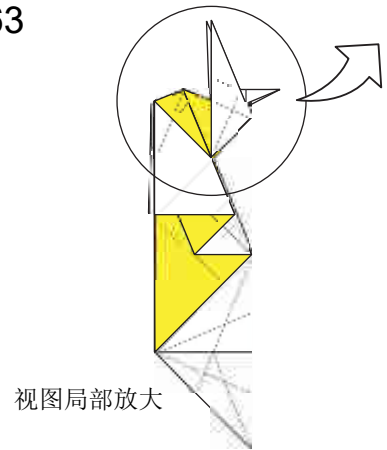

视图局部放大

64

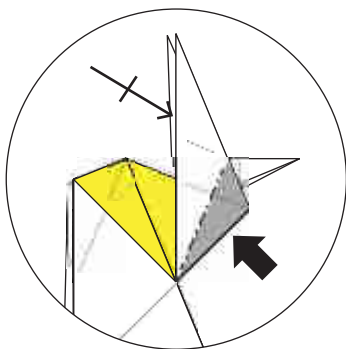

开放沉折，后侧重复

65

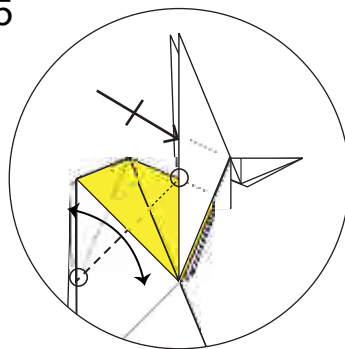

66

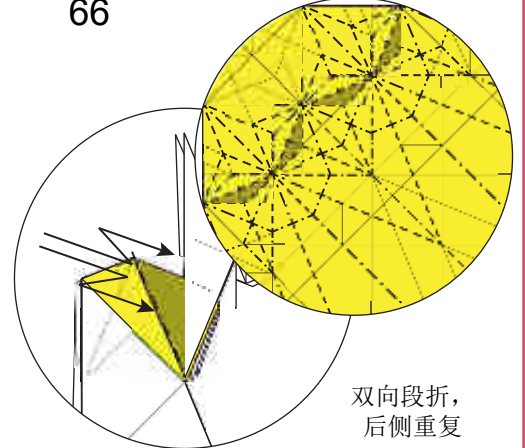

双向段折，  
后侧重复

67

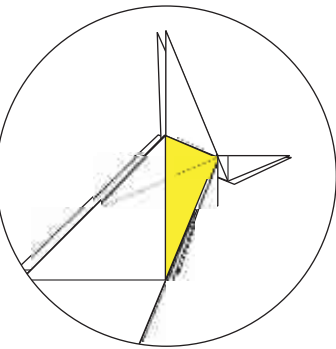

68

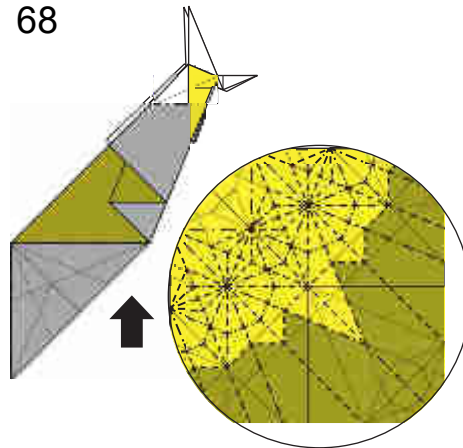

69

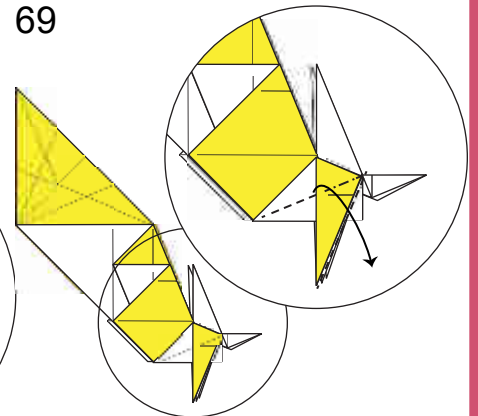

70

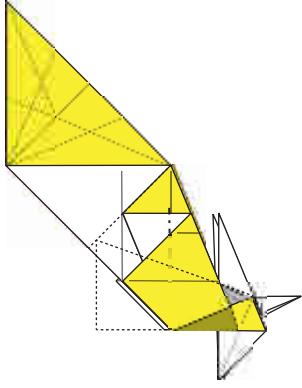

71

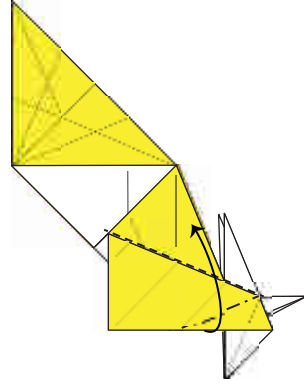

72

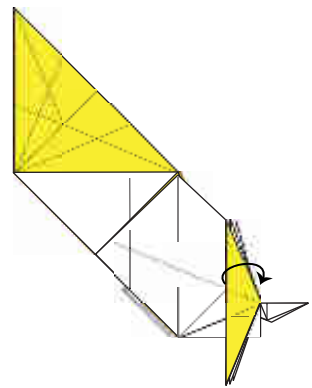

73

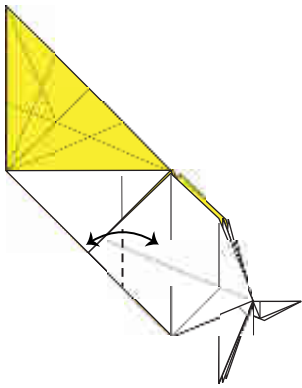

74

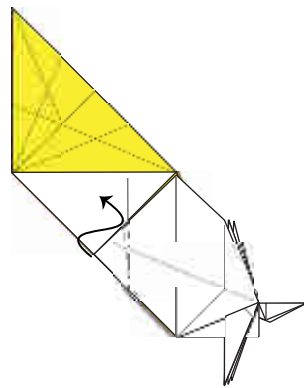

75

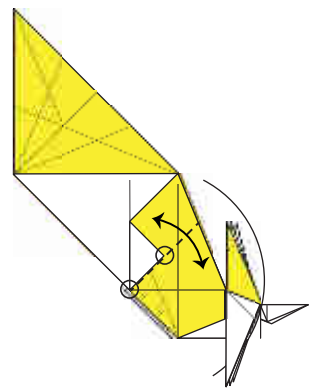

透视

76

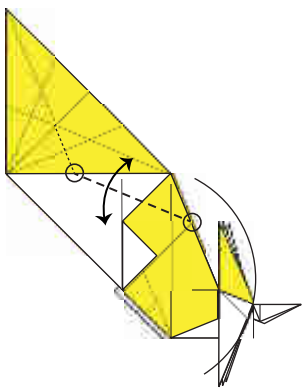

77

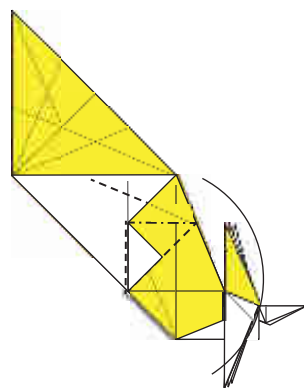

透视视角复原

78

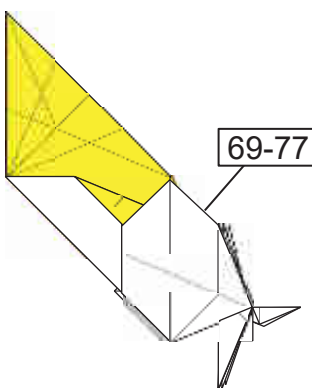

后侧重复步骤69-77

79

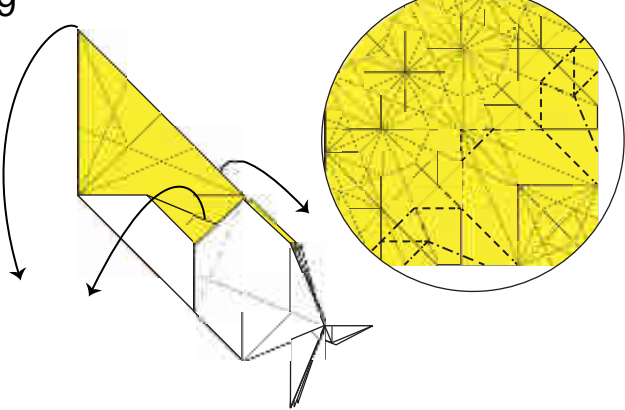

80

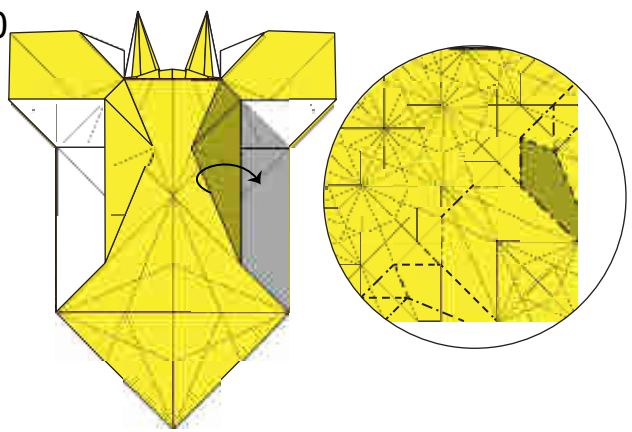

内层纸层翻出

81

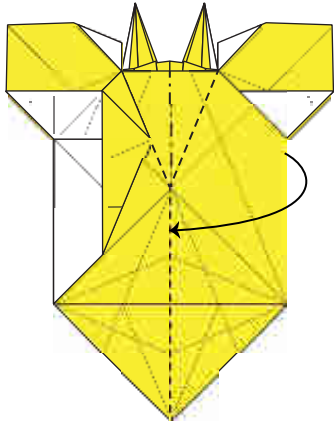

82

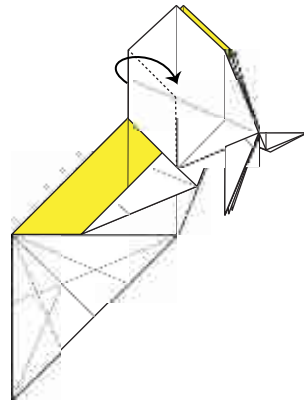

83

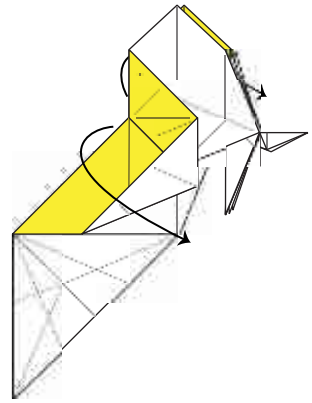

84

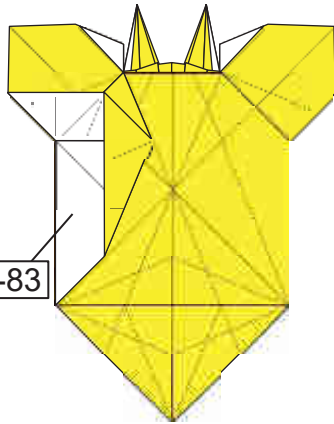

80-83

85

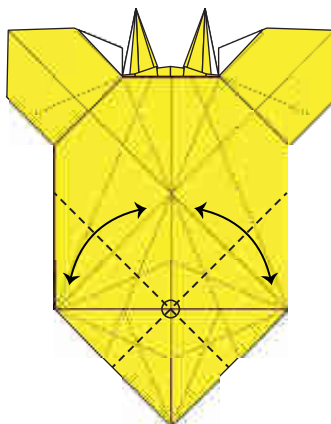

86

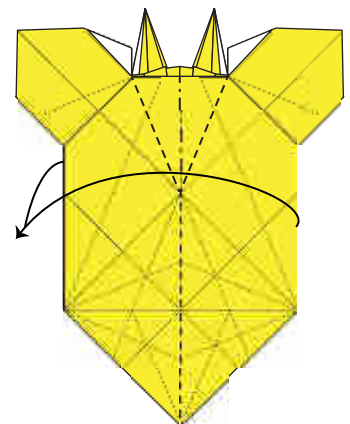

后侧重复步骤80-83

87

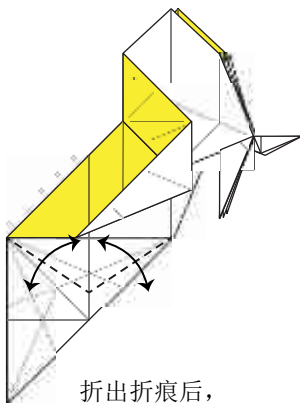

折出折痕后，  
复原至步骤86

88

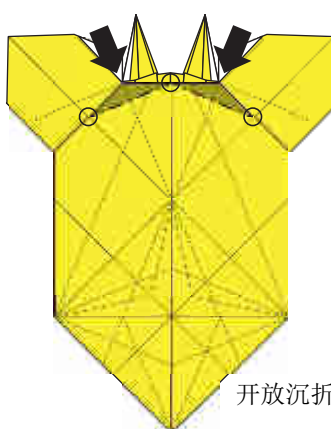

开放沉折

89

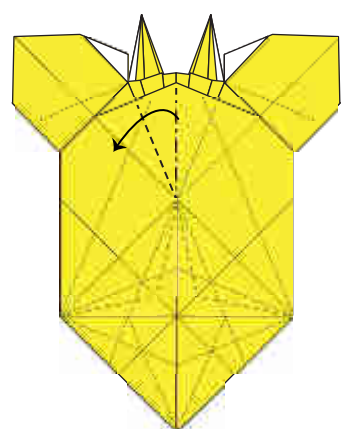

90

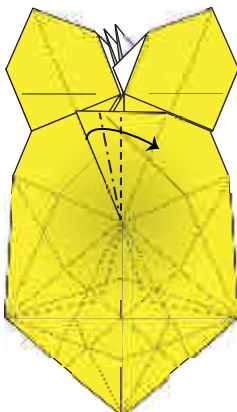

91

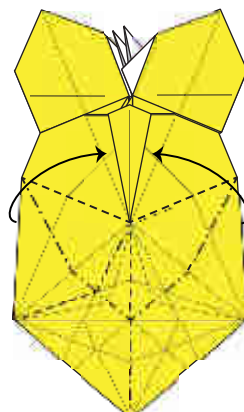

92

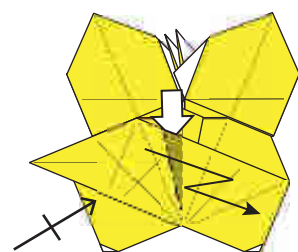

93

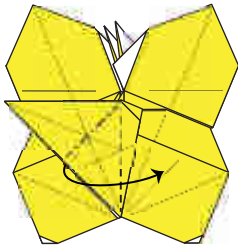

94

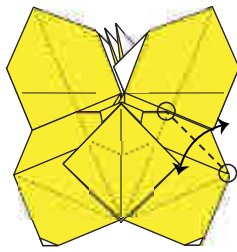

95

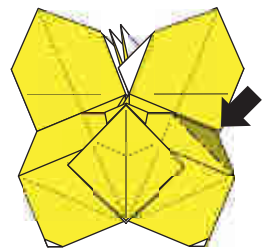

开放沉折

96

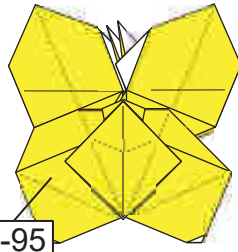

94-95

左侧重复步骤94-95

97

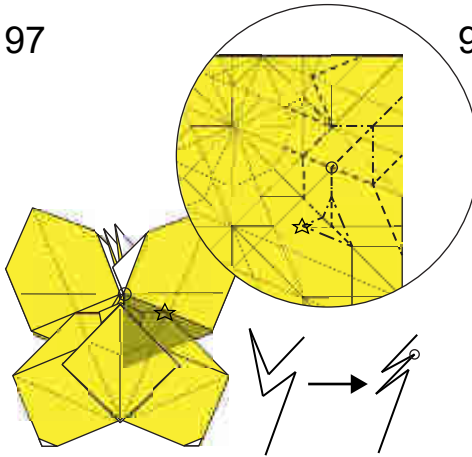

98

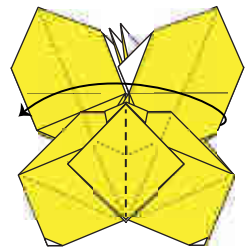

99

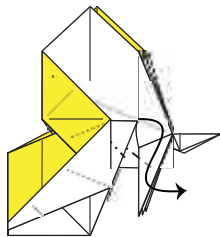

100

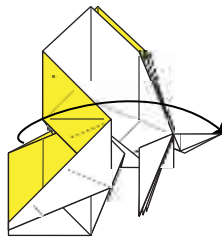

101

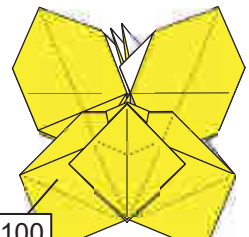

97-100

左侧重复步骤97-100

102

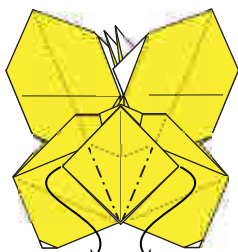

103

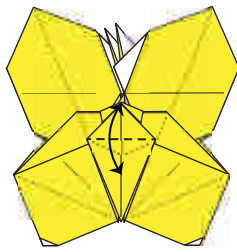

104

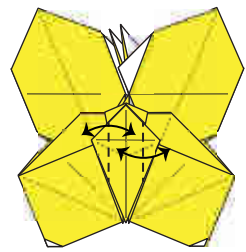



105

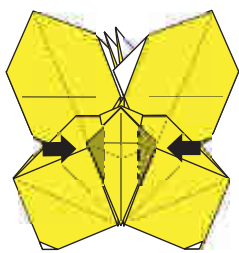

开放沉折

106

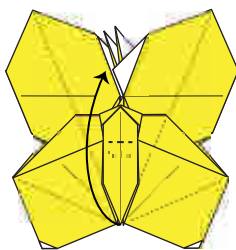

107

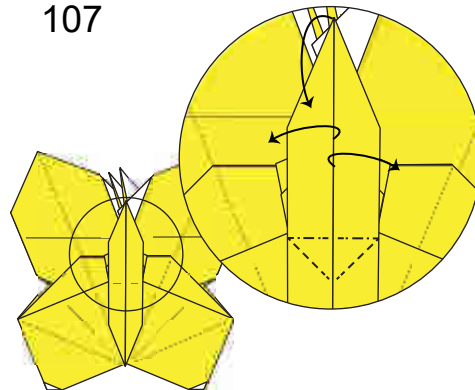

108

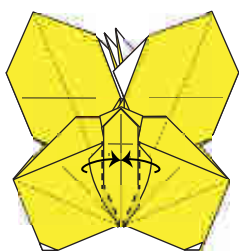

109



110

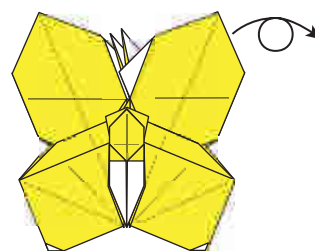

111

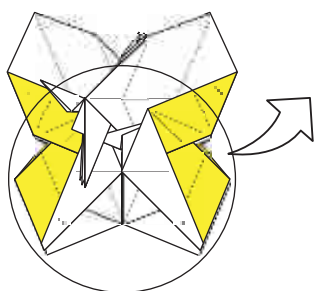

视角局部放大

112

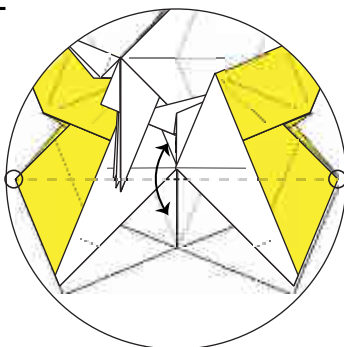

113

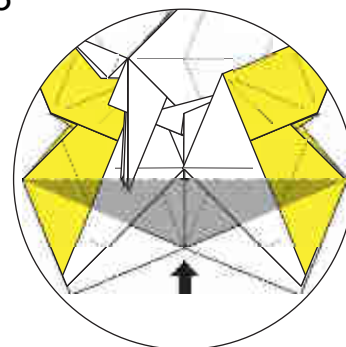

闭合沉折

114

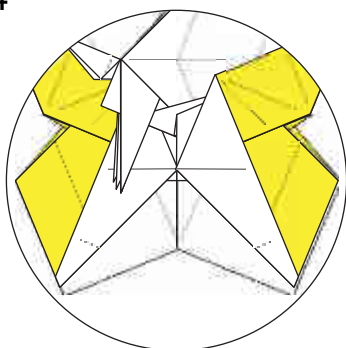

视图复原

115

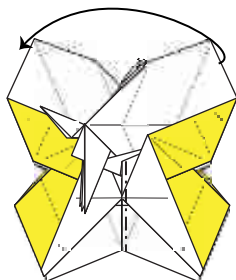

116

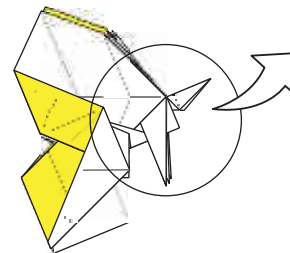

视角局部放大

117

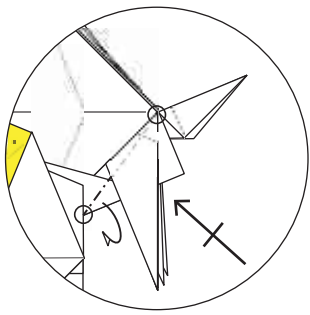

118

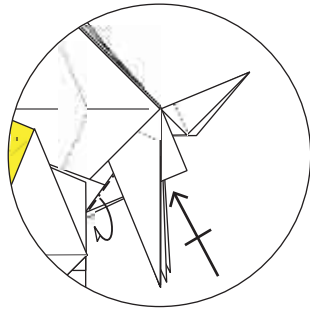

119

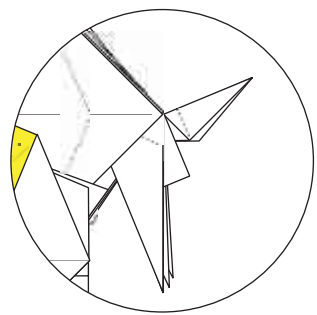

视图复原

120

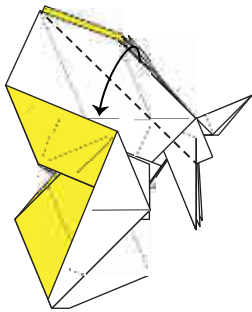

121

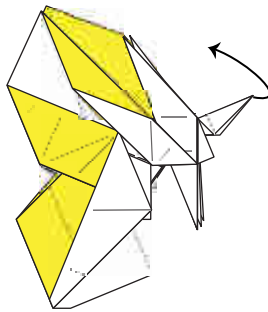

122

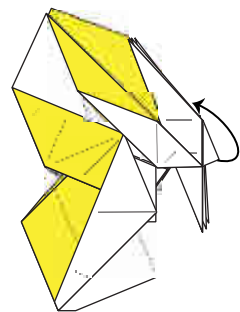

123

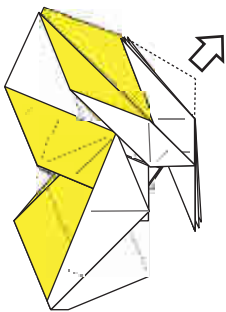

124

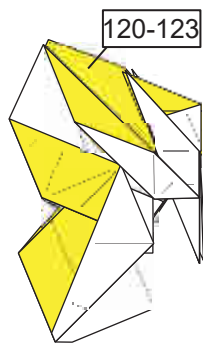

后侧重复步骤120-123

125

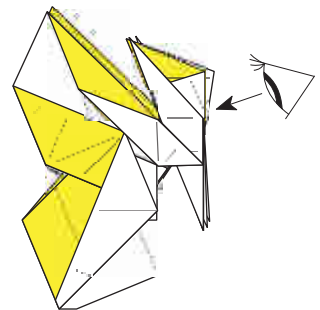

视角转换

126

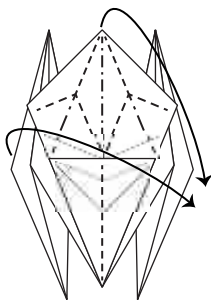

127

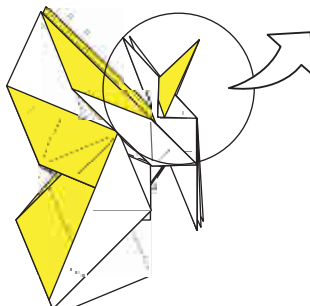

视图局部放大

128

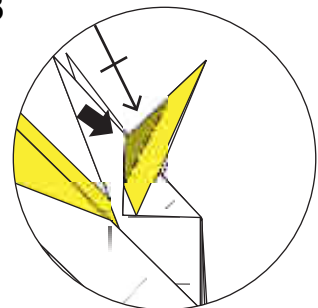

开放沉折，后侧重复

129

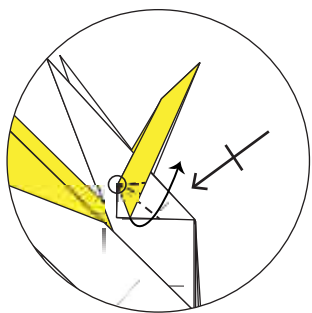

130

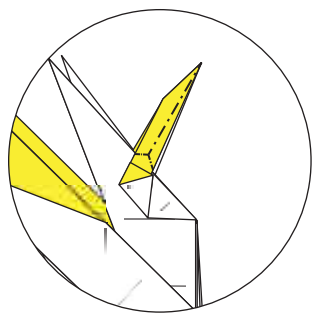

131

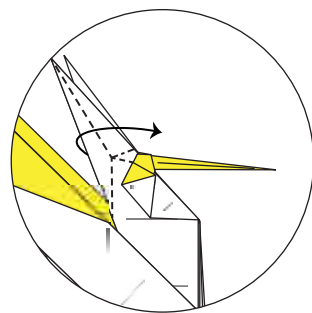

132

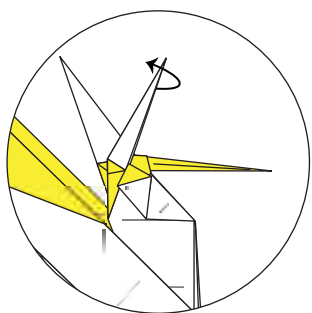

133

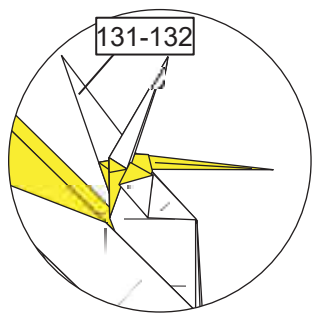

后侧重复步骤131-132

134

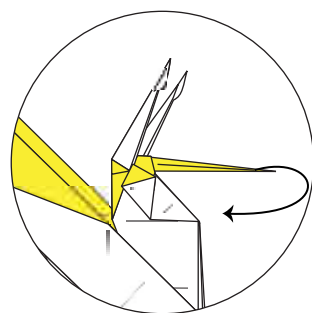

135

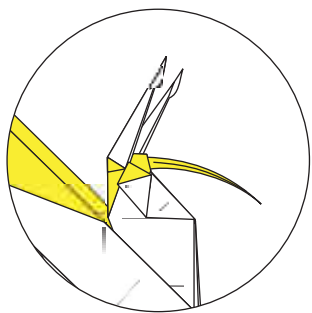

视图复原

136

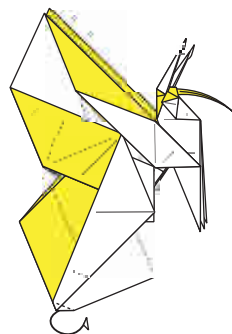

137

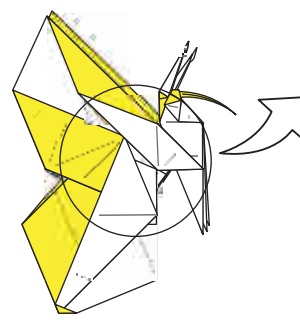

视图局部放大

138

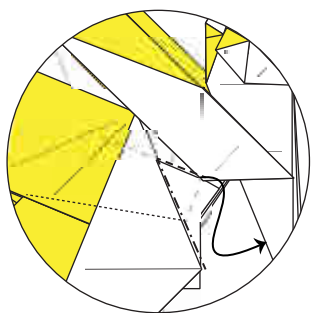

139

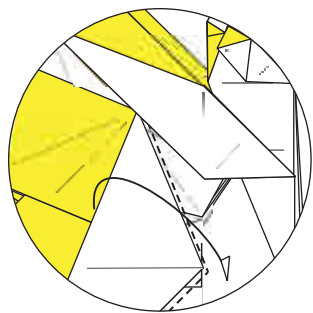

140

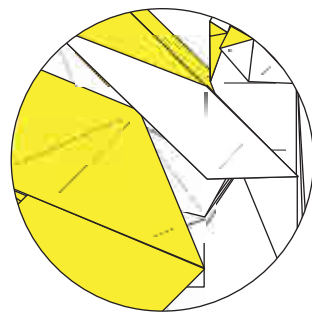

视图复原



141

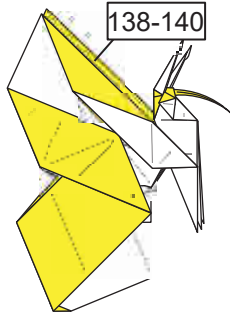

后侧重复步骤138-140

142

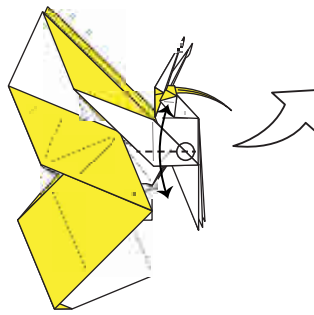

143

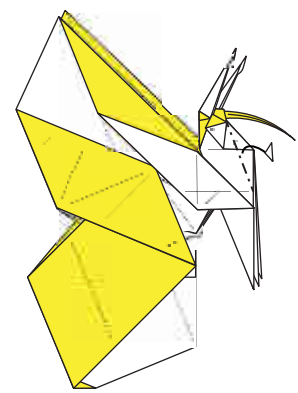

144

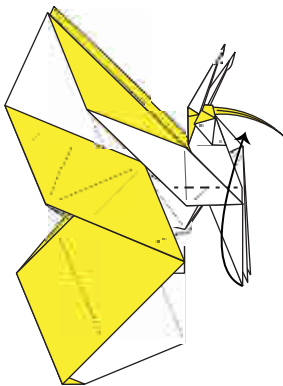

145

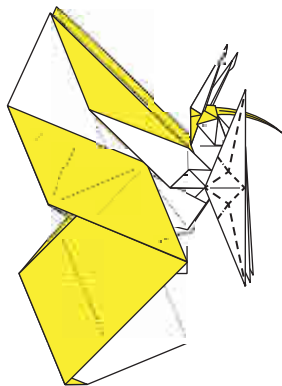

146

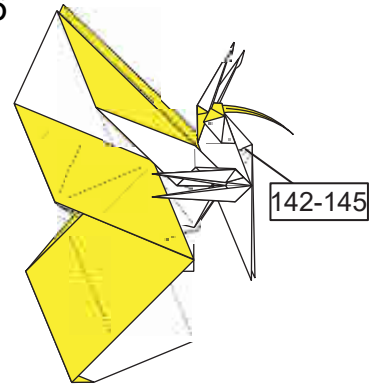

后侧重复步骤142-145

147

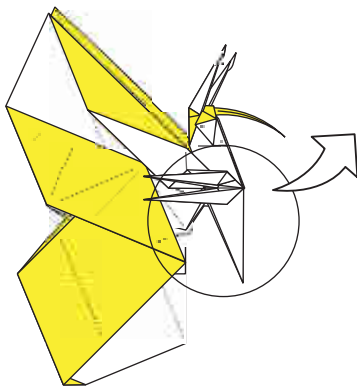

148

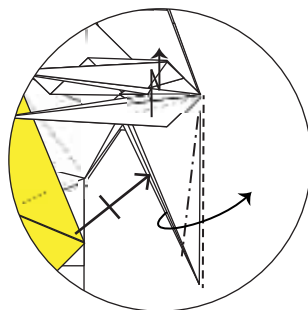

149

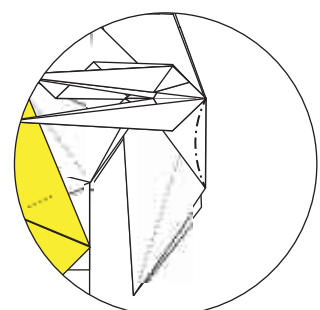

150

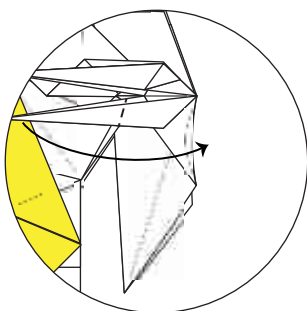

151

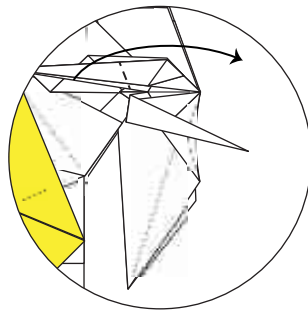

152

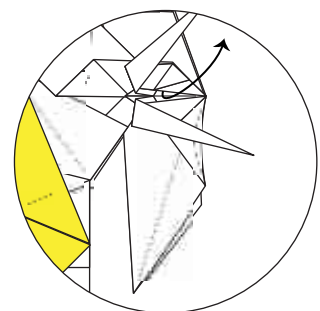

153

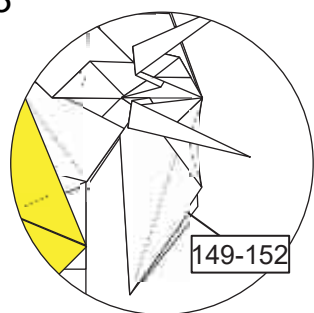

后侧重复步骤149-152

154

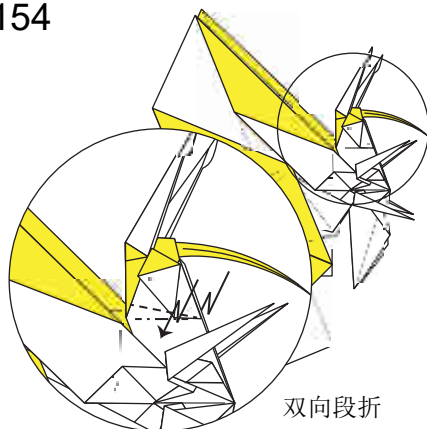

双向段折

155

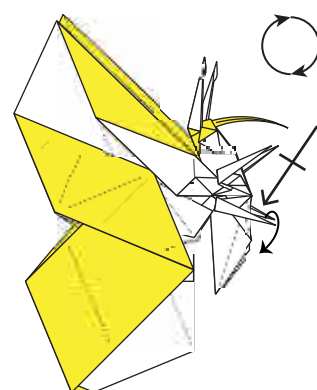

156

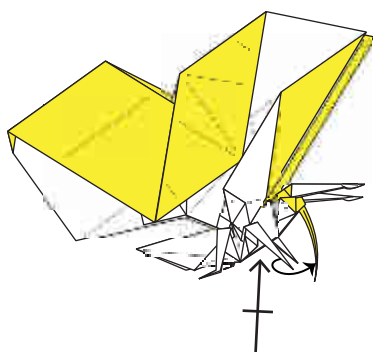

157

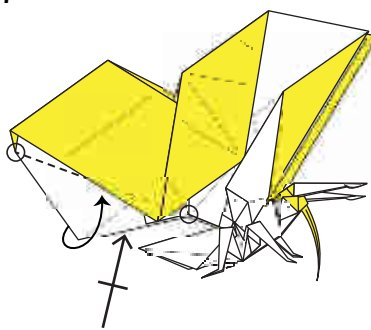

158

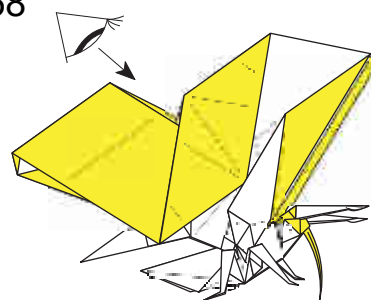

视角转换

159

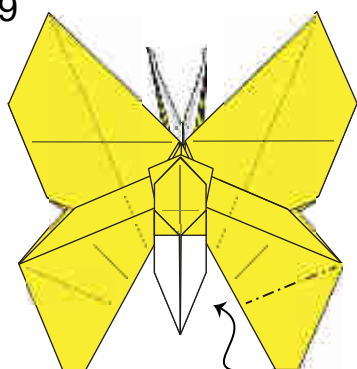

160

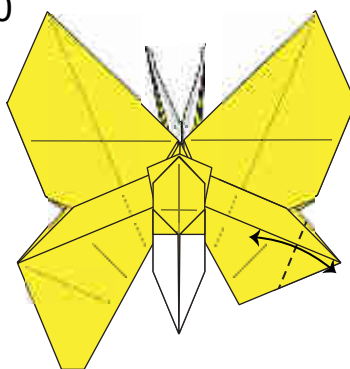

161

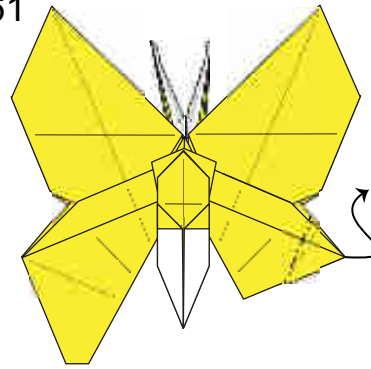

162

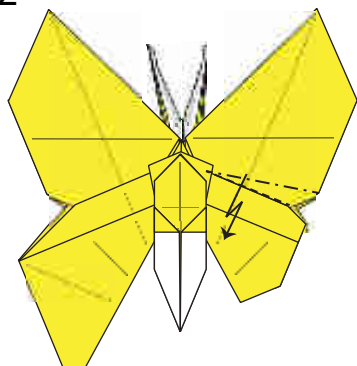

163

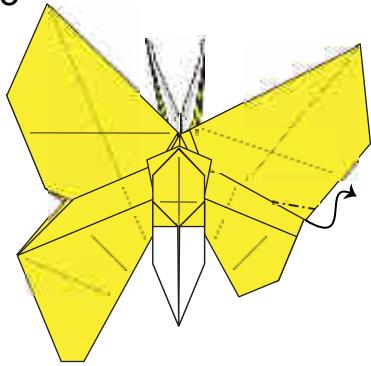

164

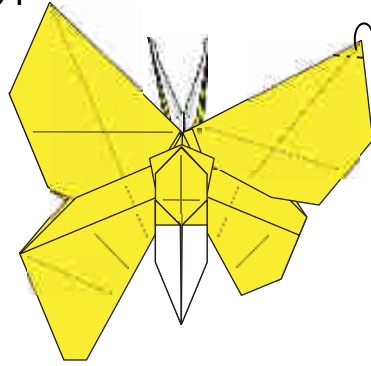

165

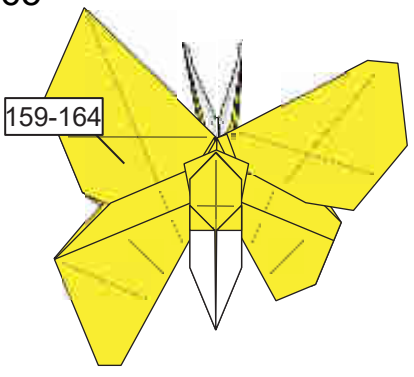

左侧重复步骤159-164

166

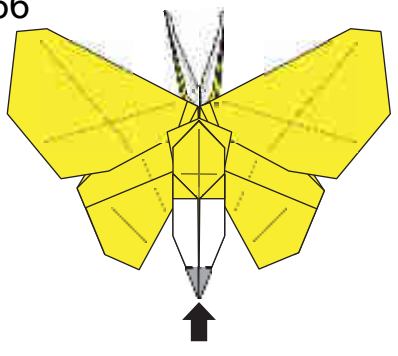

167

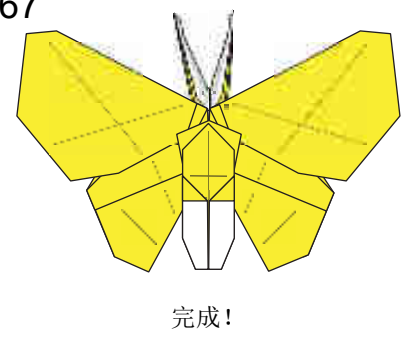

完成!

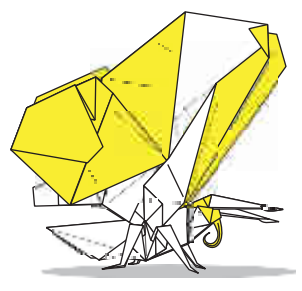



# 芳菲

设计/Designer: 渔鱼余  
 图示/Diagramer: 嘲风

推荐用纸/Paper :  
 - 教育折纸 15x15 cm

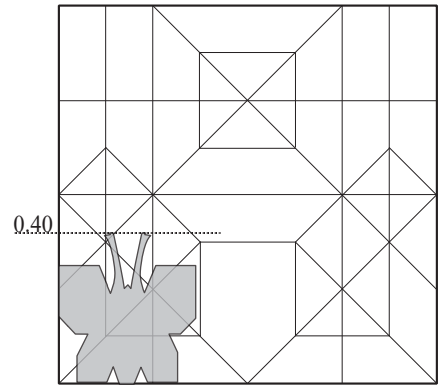
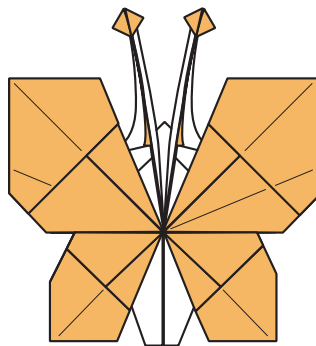

1

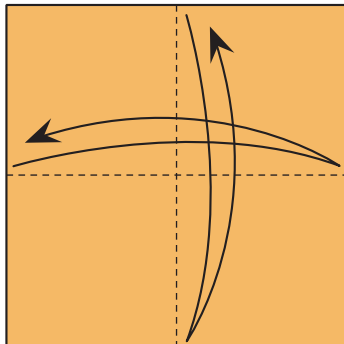

折出折痕

2

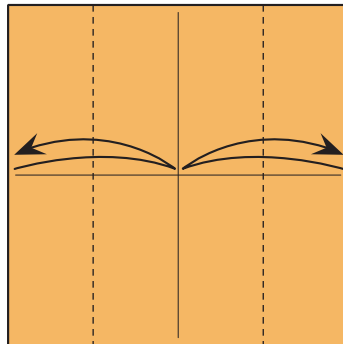

两边向中间折

3

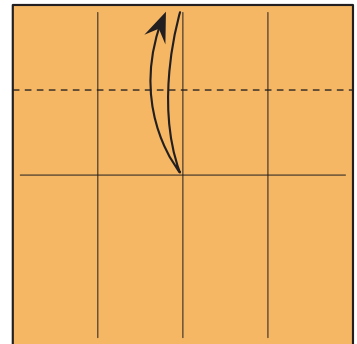

折出折痕

4

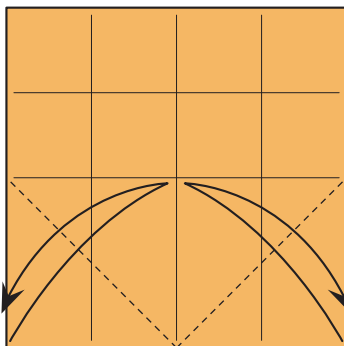

向中间折, 折出折痕

5

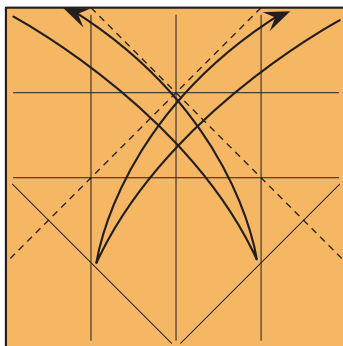

向中间折, 取得折痕

6

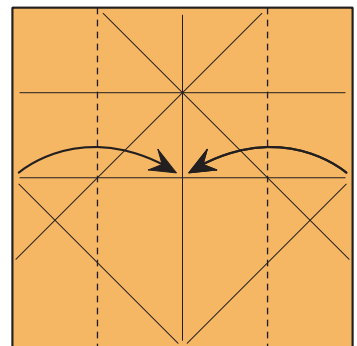

向中间折

7

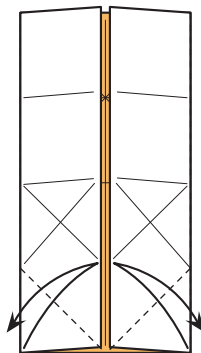

取得折痕

8

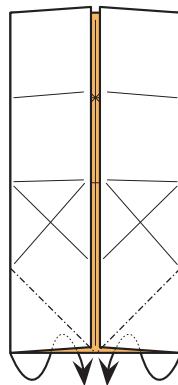

内翻折

9

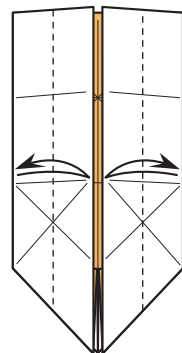

向中间折, 取得折痕

10

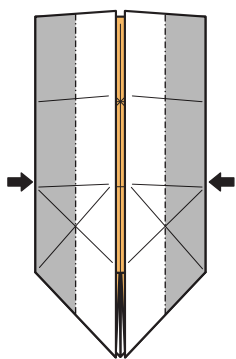

开放沉折

11

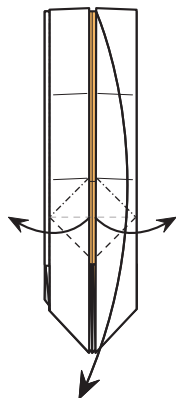

内部两层打开，向下压平

12

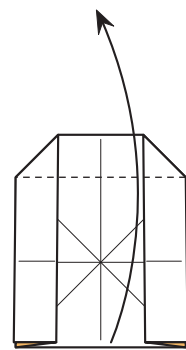

向上折叠

13

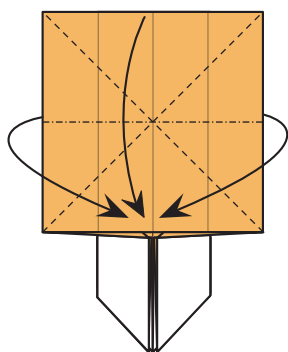

向中间聚合

14

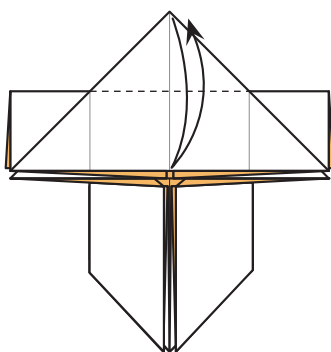

向下取得折痕

15

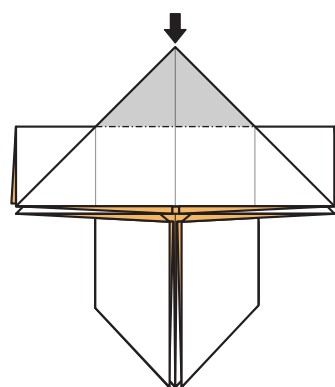

开放沉折

16

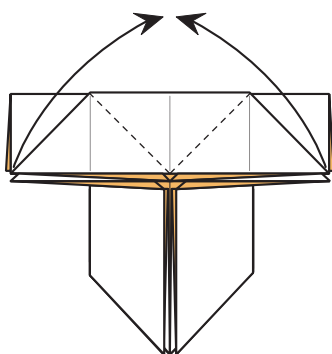

两边向上折叠

17

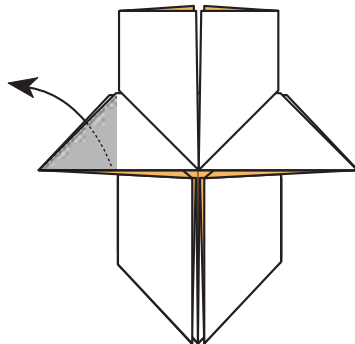

将内部翻出

18

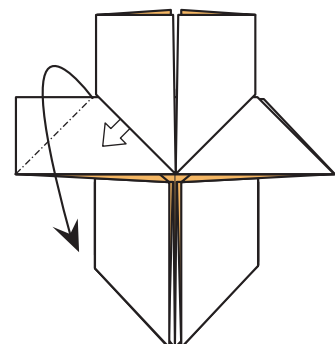

向下折，并将内部纸层抽出

19

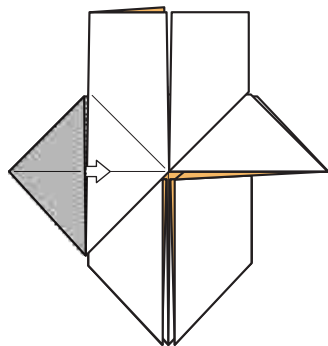

内部纸层翻出

20

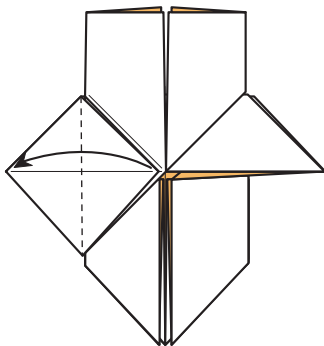

向左折叠

21

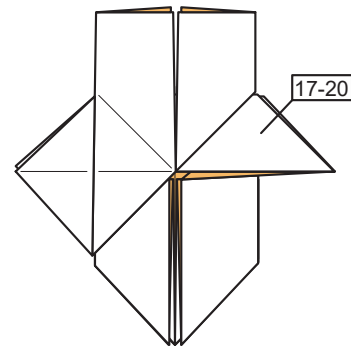

右侧重复17-20步

22

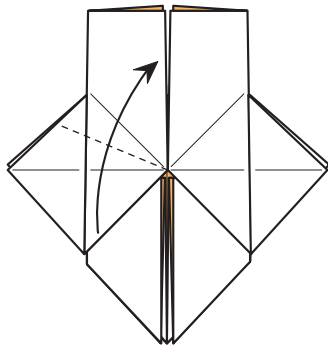

向上折叠

23

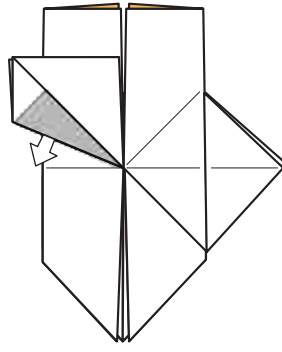

后面纸层拉出

24

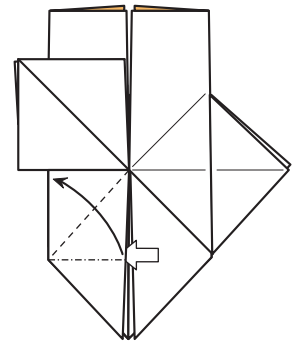

展开压平

25

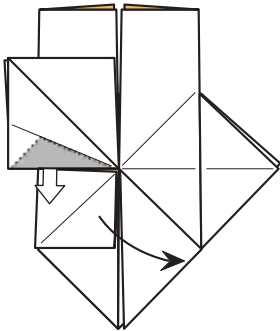

下面向右并将隐藏纸层拉出

26

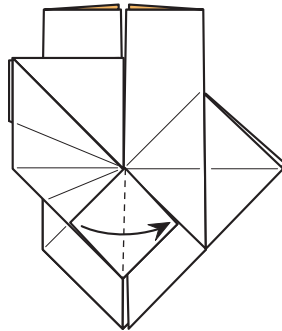

向右折叠

27

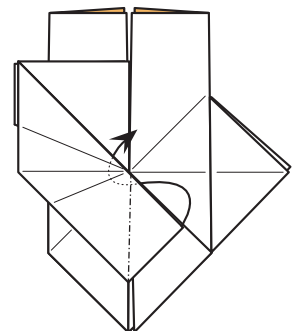

内翻折

28

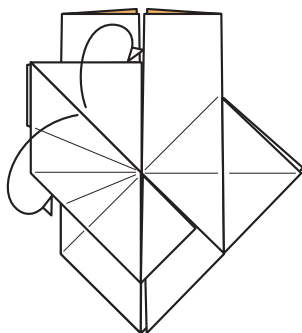

外翻折

29

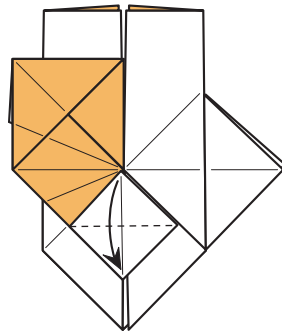

向下折叠

30

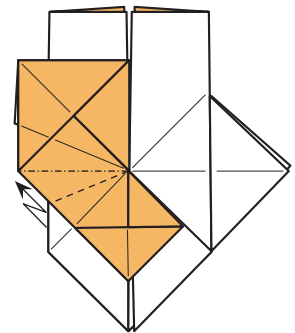

按照线段折

31

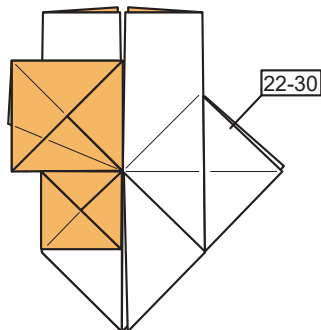

右侧重复22-30步

32

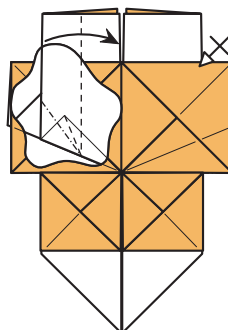

向右旋转压平

33

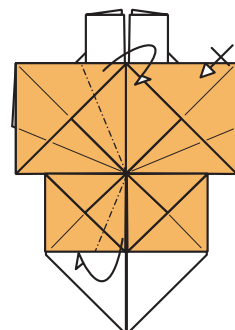

向后折

34

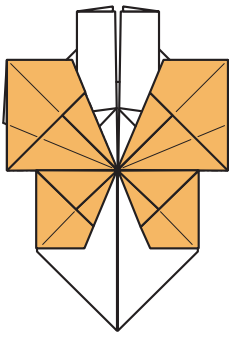

翻面

35

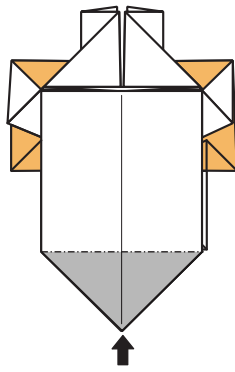

沉折

36

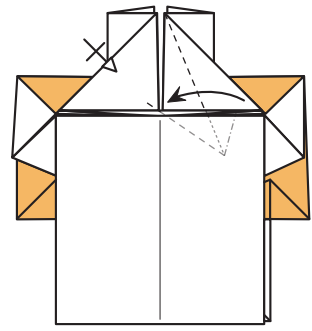

折叠

37

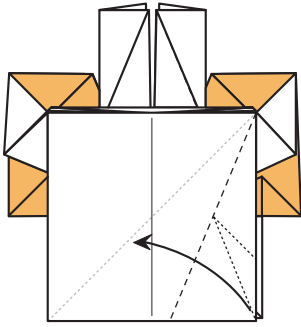

折叠，注意背后纸层

38

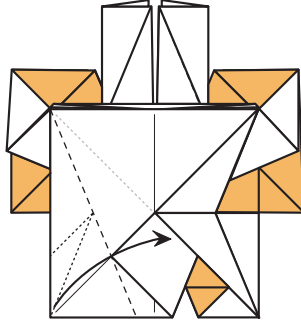

与右侧相同

39

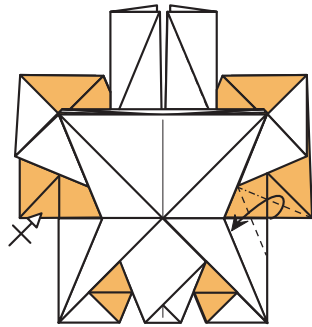

向内谷折压平

40

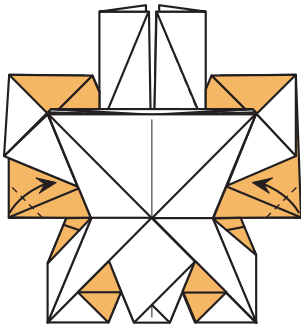

谷折

41

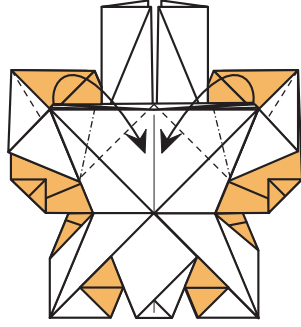

沿折线折叠，压平

42

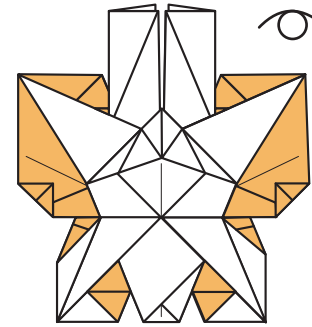

翻面

43

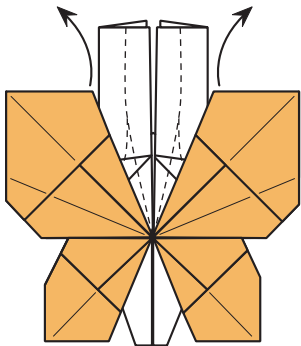

整理触角形状

44

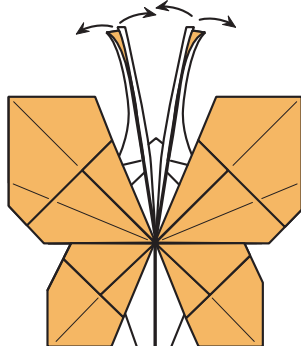

将顶端展开

45

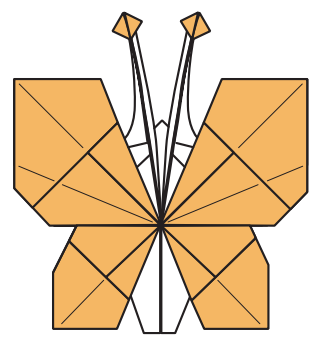

完成





书  
香



# 书香

设计/Designer: 嗑盐汪  
 图示/Diagramer: 小杨

推荐用纸/Paper :  
 - 教育折纸 15x15 cm

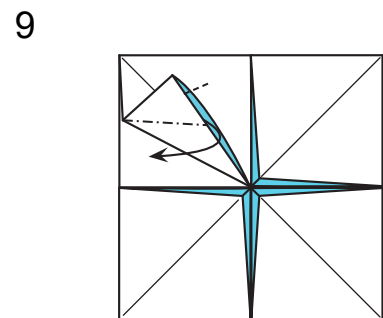
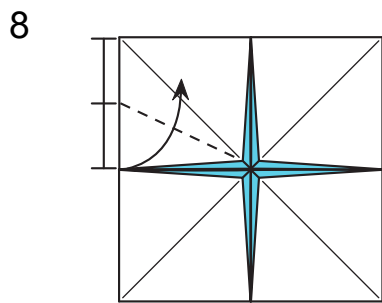
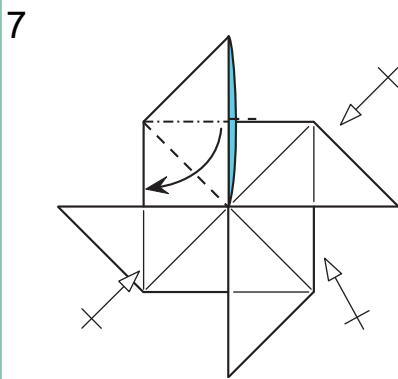
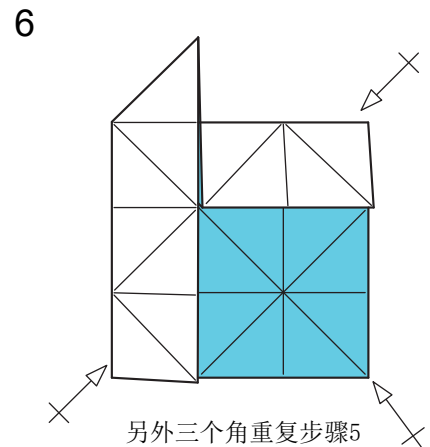
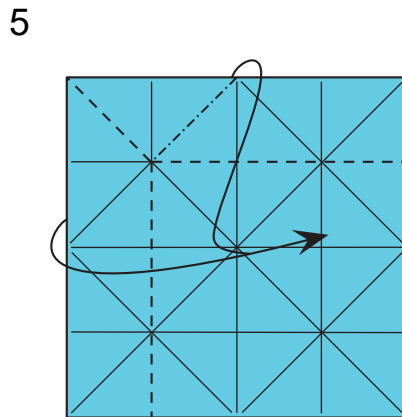
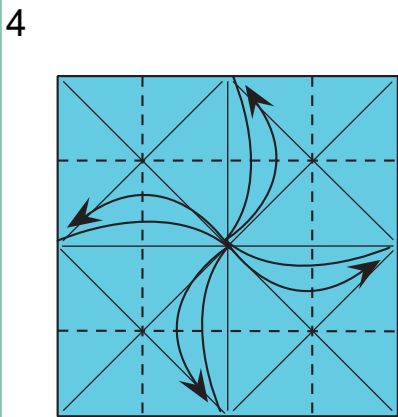
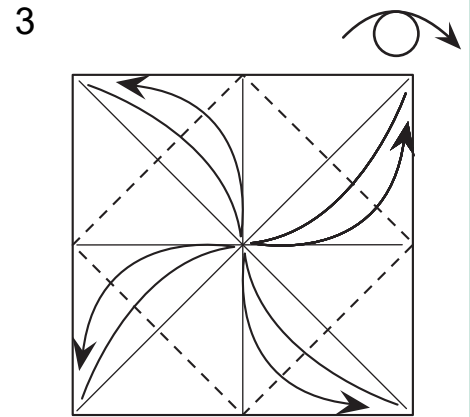
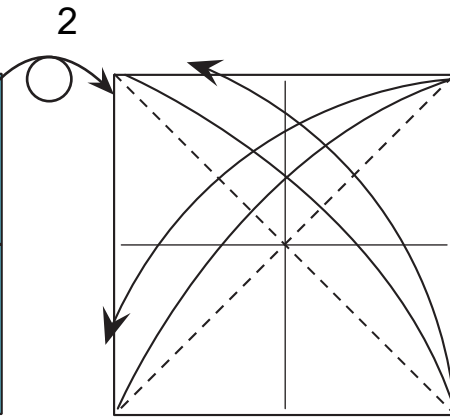
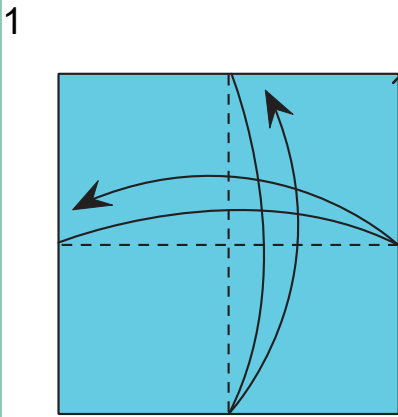
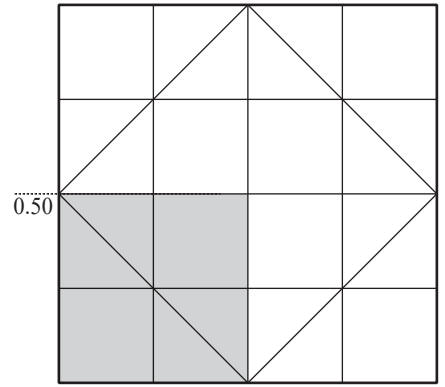
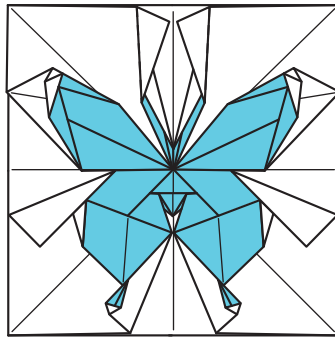

10

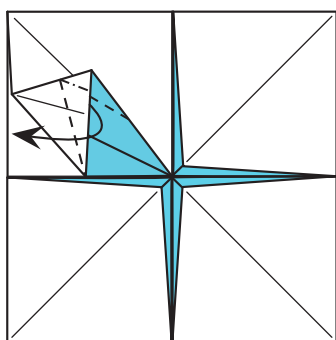

旋转折叠

11

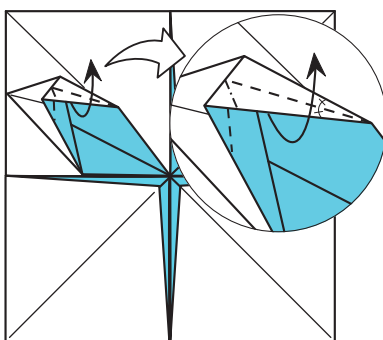

旋转折叠

12

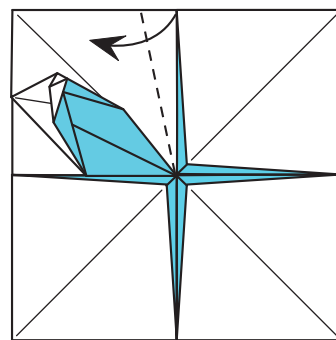

13

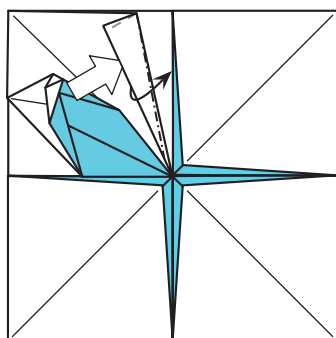

旋转折叠，折出触角

14

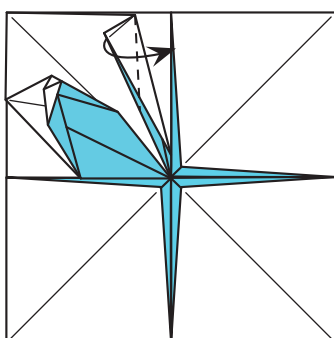

15

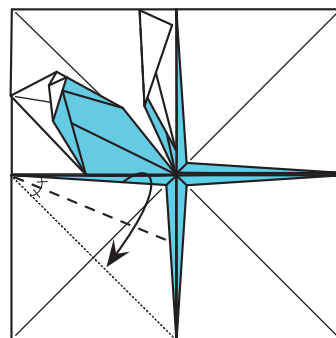

16

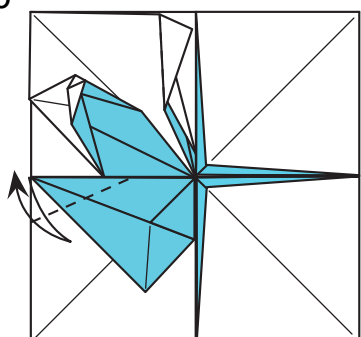

17

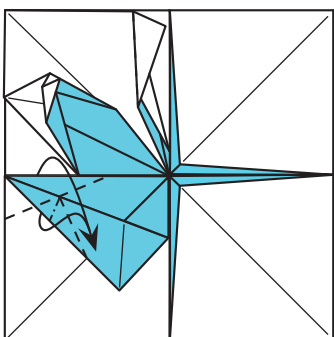

上侧折下来，内侧旋转折

18

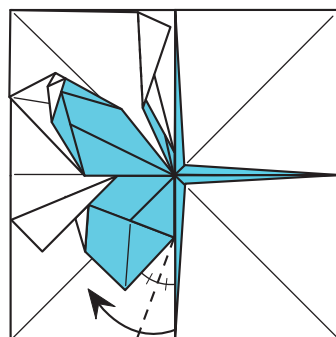

19

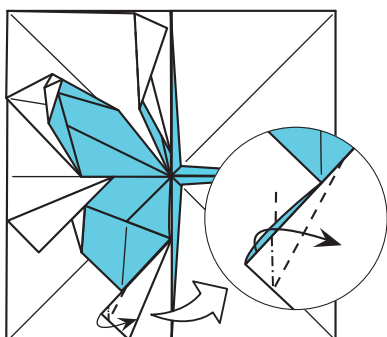

打开压平

20

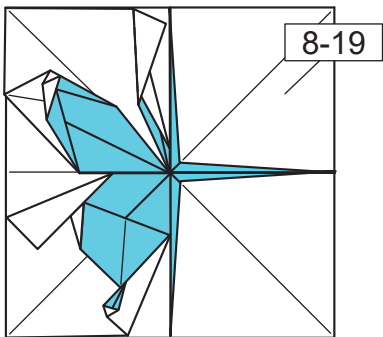

右侧重复步骤8-19

21

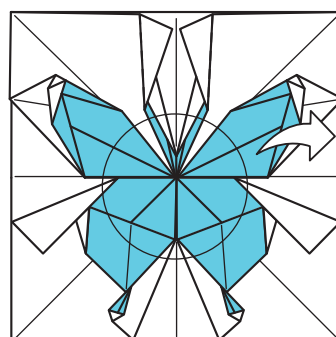

视角局部放大

22

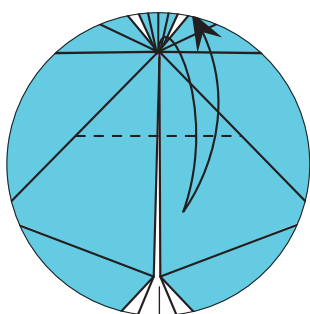

23

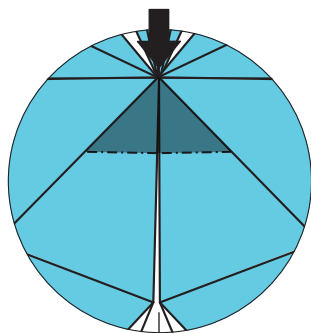

阴影处引入内侧

24

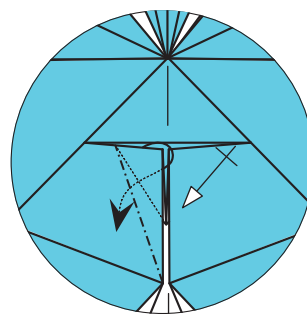

向内旋转折

25

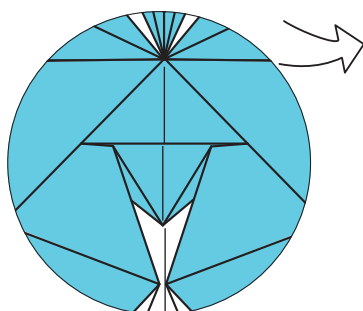

视角复原

26

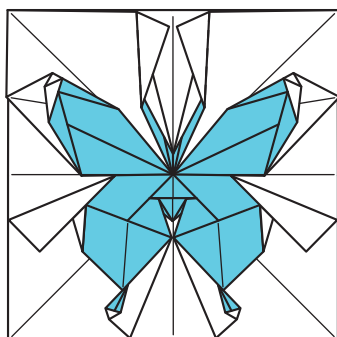

完成啦~

閃蝶



# 闪蝶

设计/Designer: 孤雏  
 图示/Diagramer: 银铃

推荐用纸/Paper :  
 - 教育折纸 20x20 cm

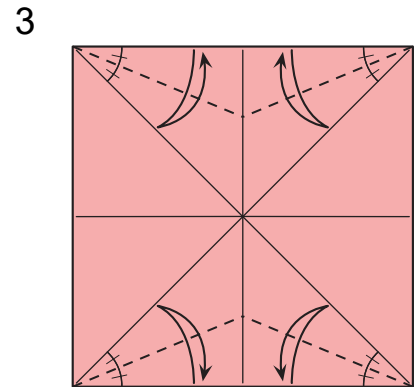
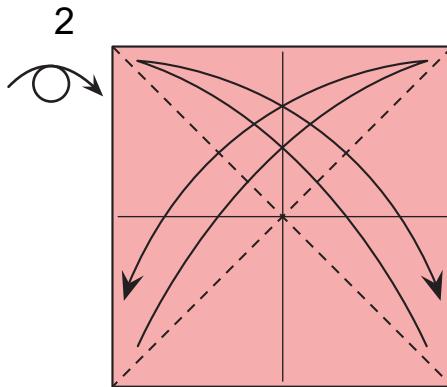
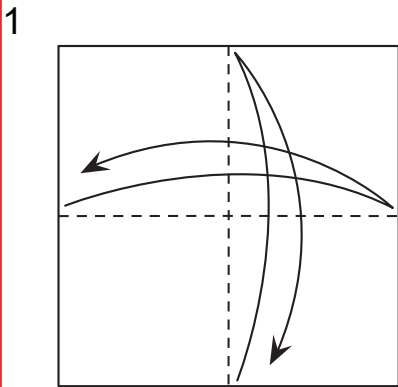
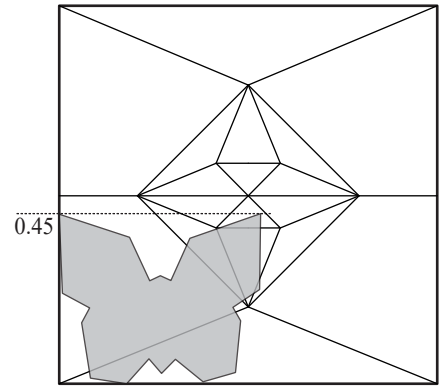
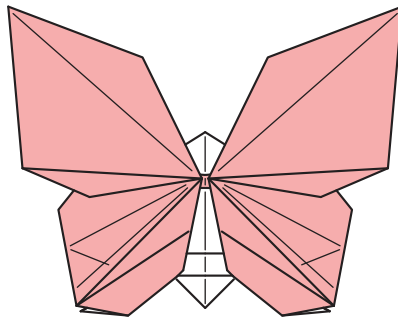

折出角平分线

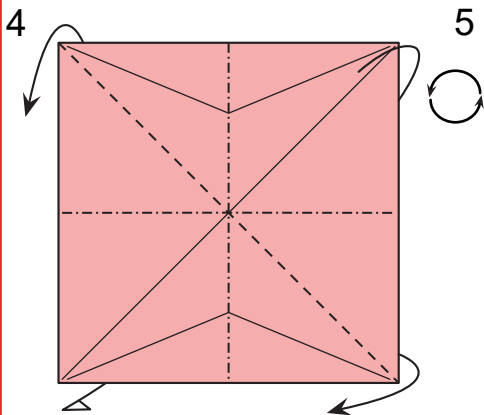

双正方形

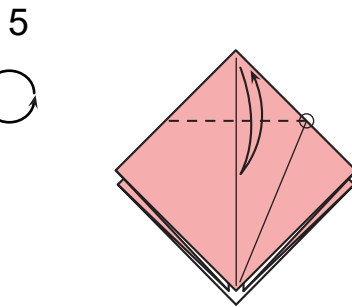

连接两点折出折痕

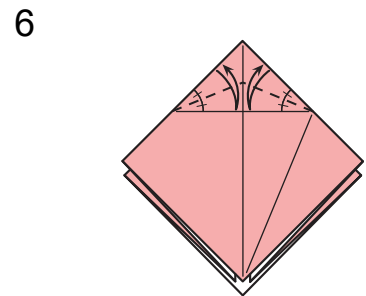

折出角平分线，再全部展开

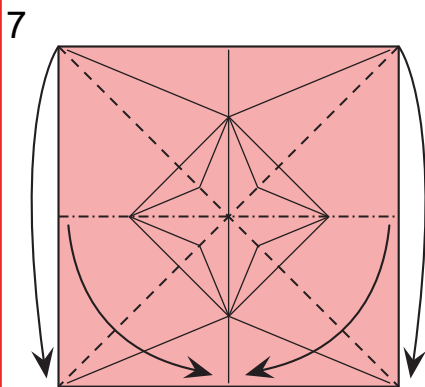

双三角形

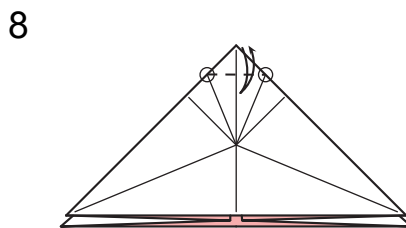

连接两点折出折痕

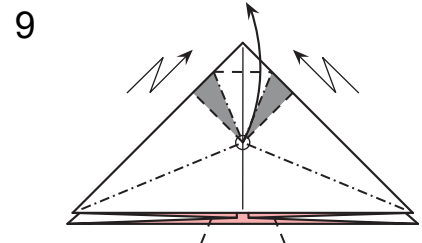

两侧双向段折，○向上提

10

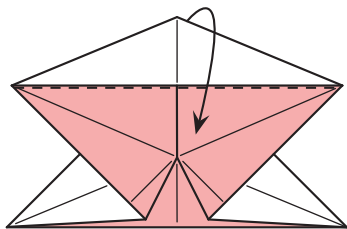

11

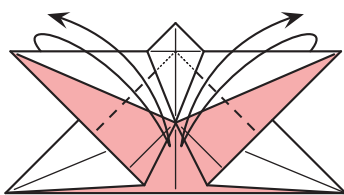

折出角平分线

12

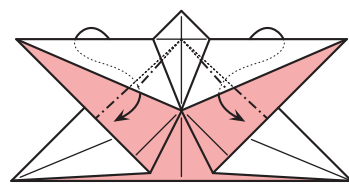

两边内翻折

13

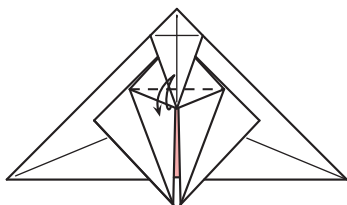

14

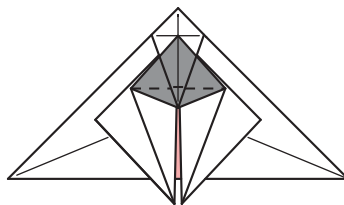

引出内部纸层

15

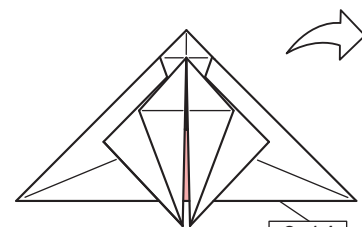

后侧重复步骤9-14

16

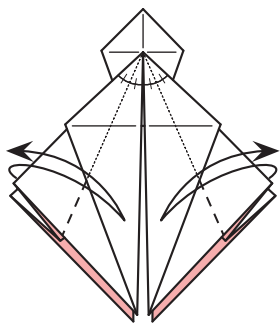

折出角平分线

17

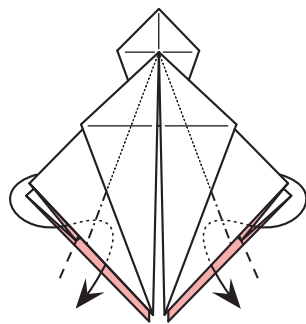

两侧内翻折

18

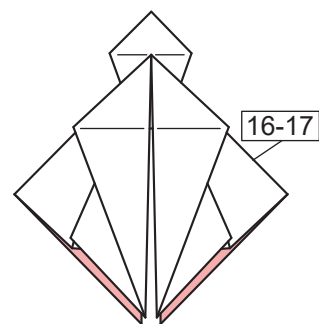

后侧重复步骤16-17

19

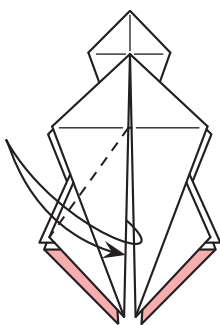

20

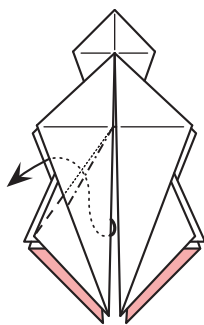

内翻折

21

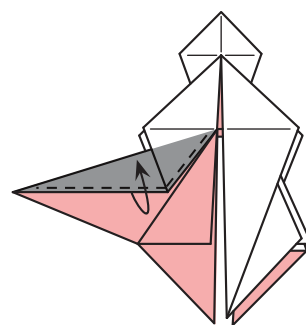

翻色



22

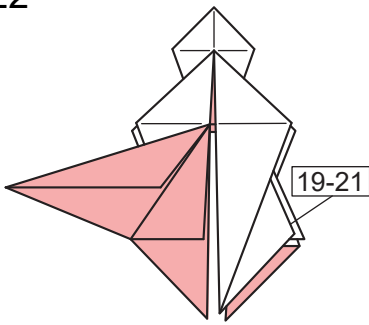

右侧重复步骤19-21

23

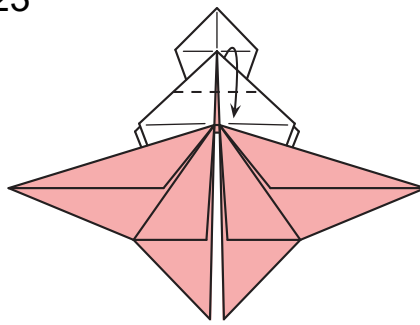

24

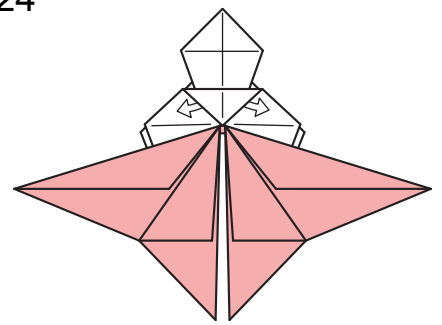

引出内部纸层

25

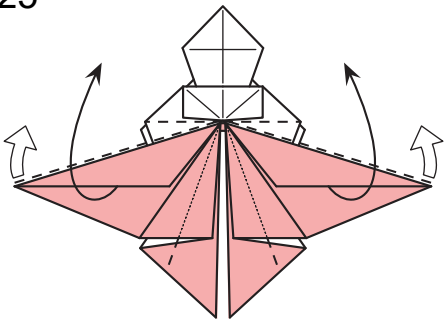

两侧旋转折

26

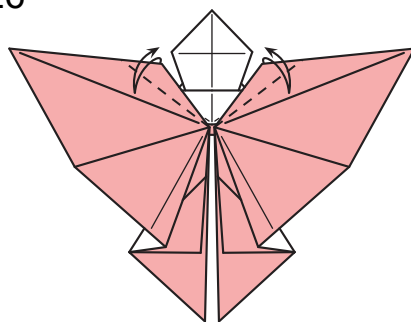

27

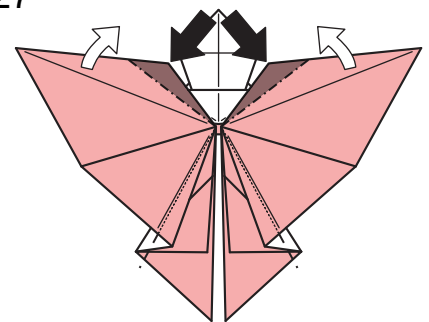

沉折加旋转折

28

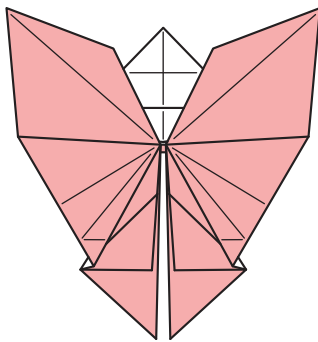

翻面

29

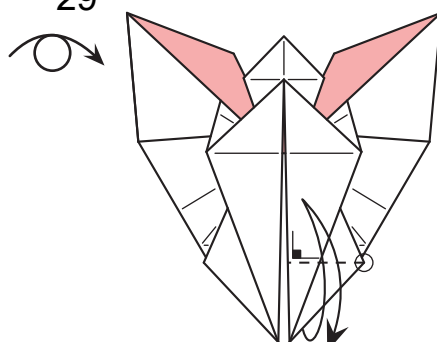

30

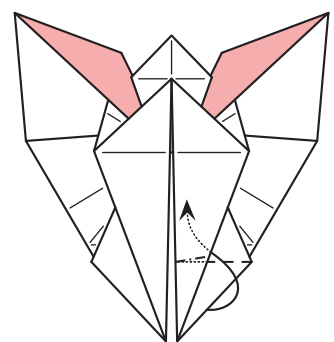

内翻折

31

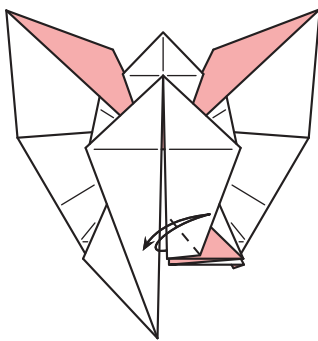

32

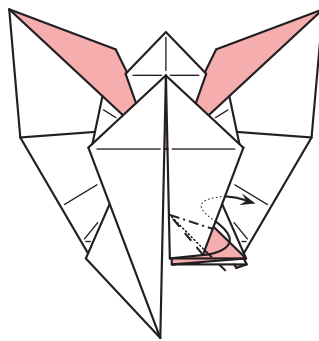

向内旋转折

33

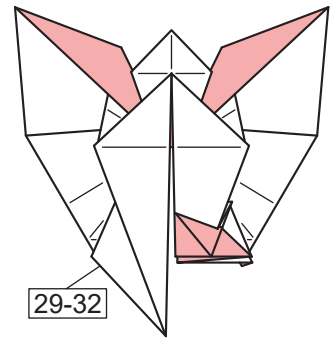

左侧重复步骤29-32

34

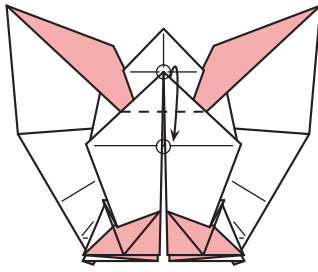

35

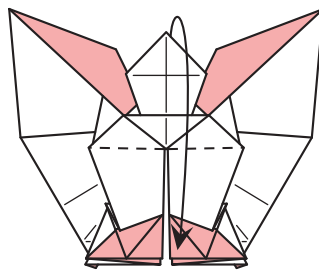

36

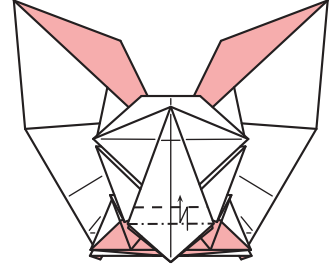

37

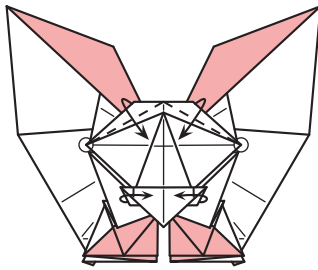

38

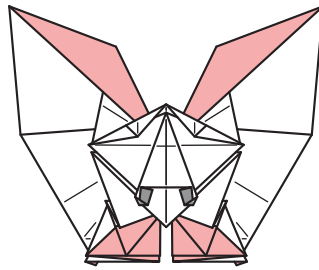

39

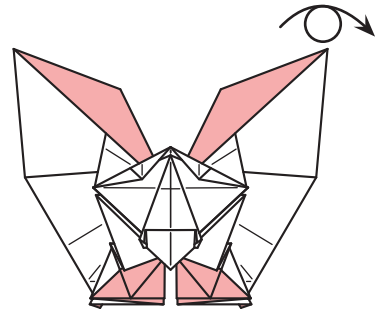

引入内侧

翻面

40

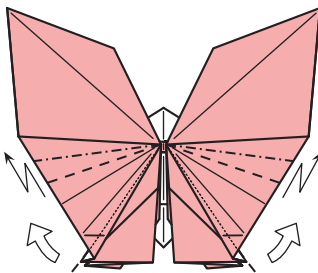

两侧旋转段折

41

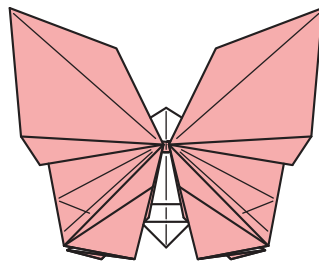

翻面

42

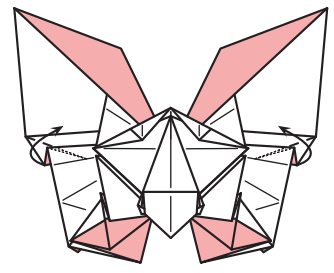

两侧内翻折

43

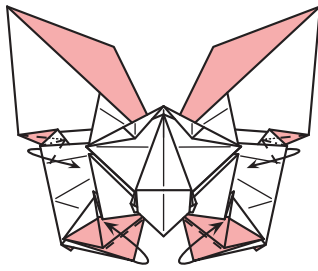

整形

44

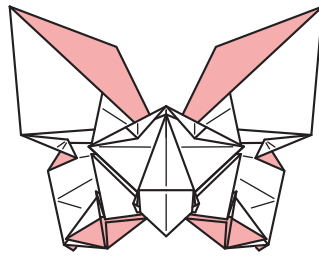

翻面

45

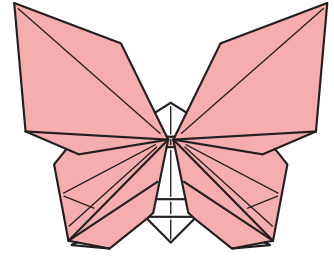

完成!



馆  
丝



# 缩丝

设计/Designer: 林伊桐

图示/Diagramer: 徐涛 (逍遥丸子)

推荐用纸/Paper :

- 绵箔纸 24x24 cm

- 影纹纸 24x24 cm

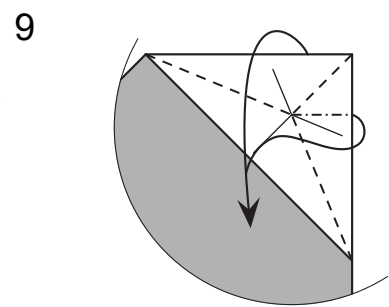
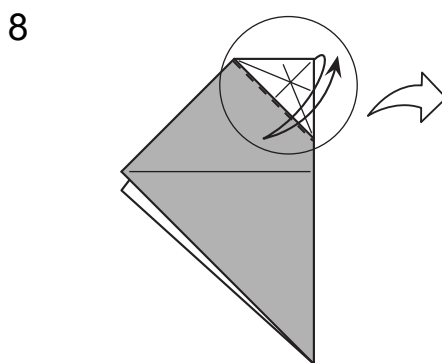
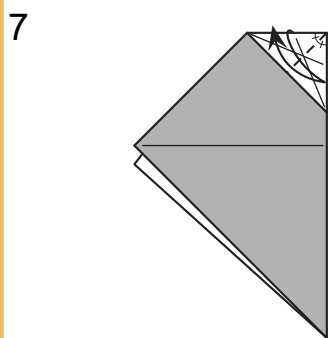
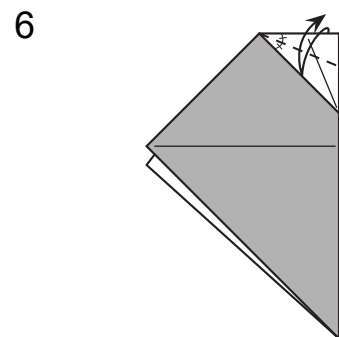
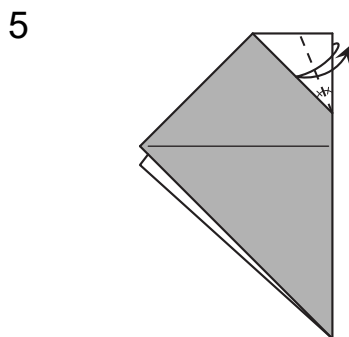
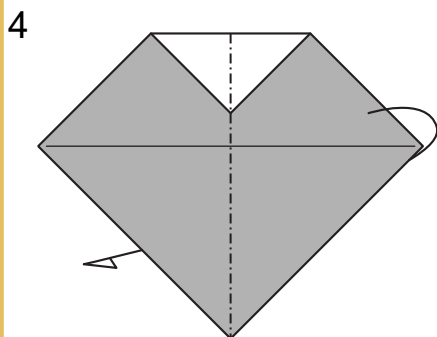
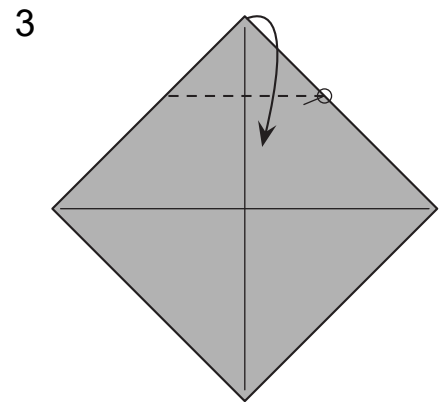
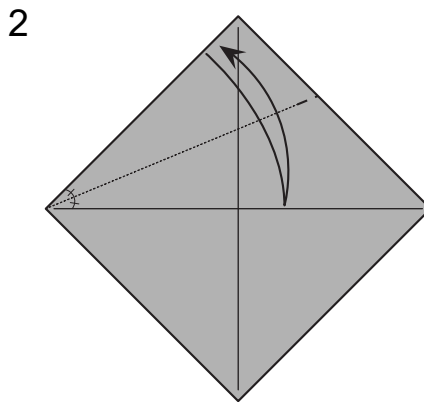
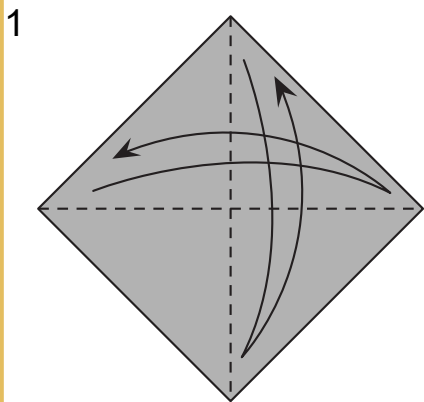
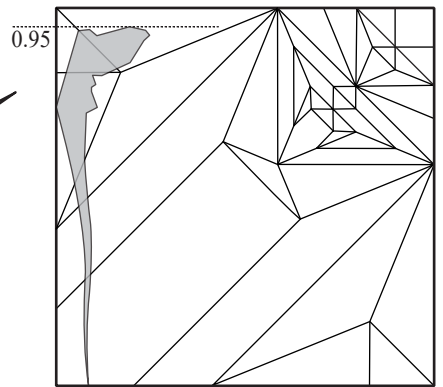
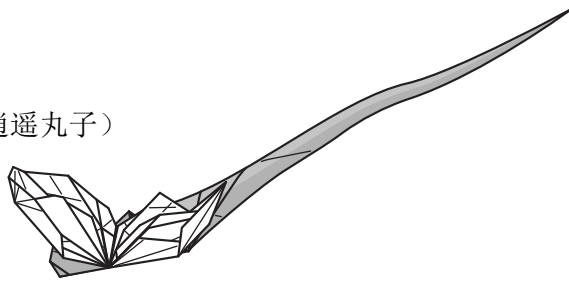

兔耳折

10

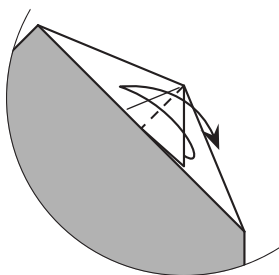

11

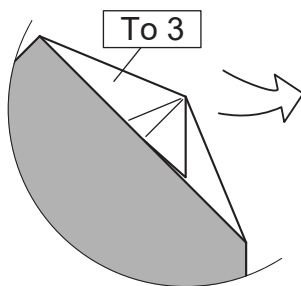

复原至步骤3

12

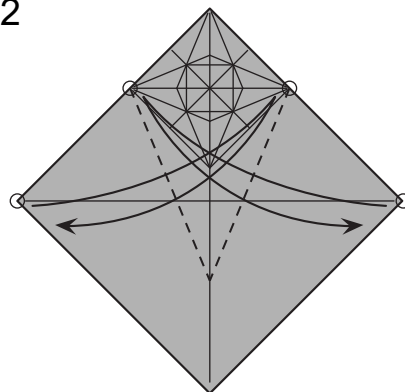

13

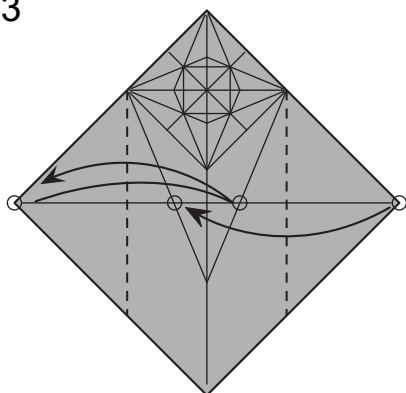

14

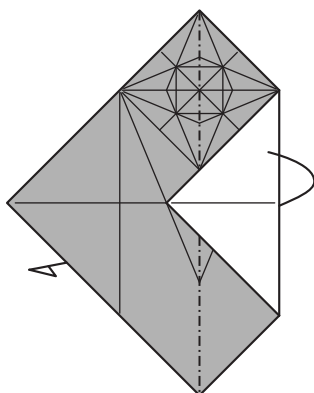

15

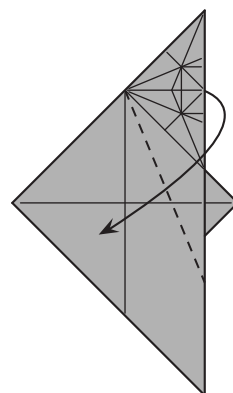

16

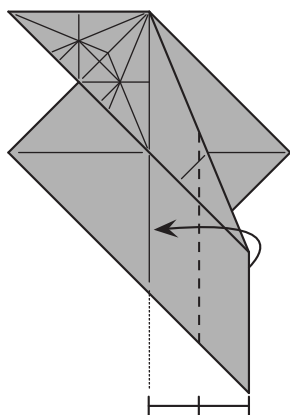

17

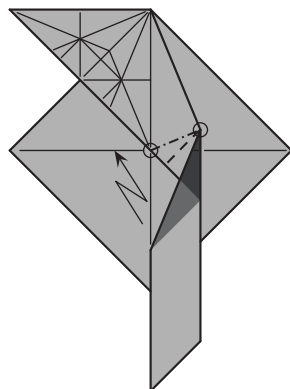

引出纸层，向内旋转段折

18

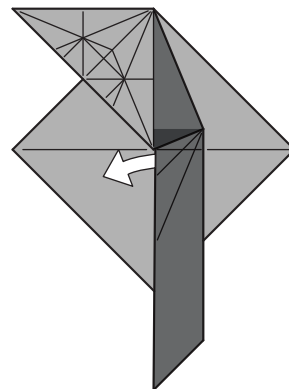

引出内部纸层

19

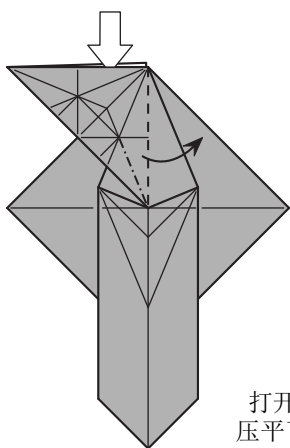

打开只  
压平下部

20

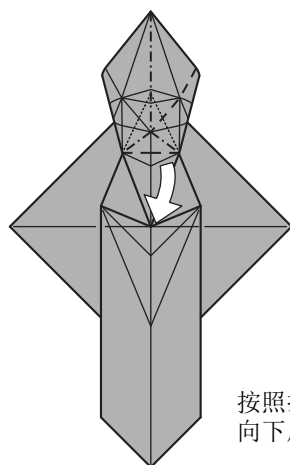

按照折痕  
向下压平

21

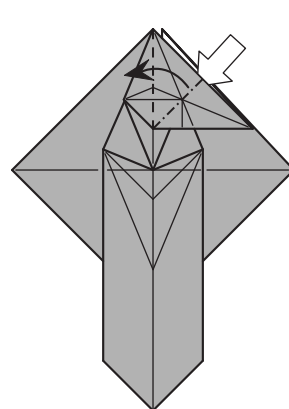

打开压平

22

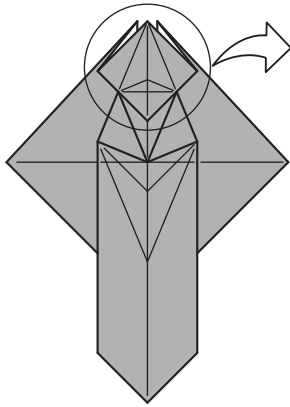

视角局部放大

23

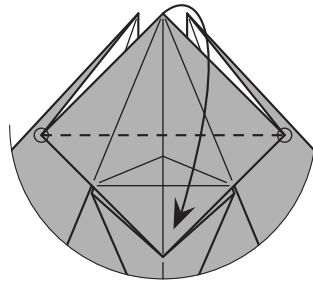

24

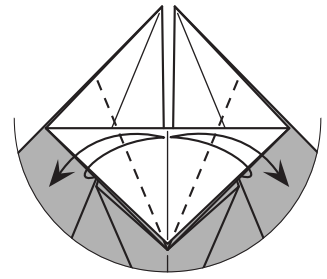

25

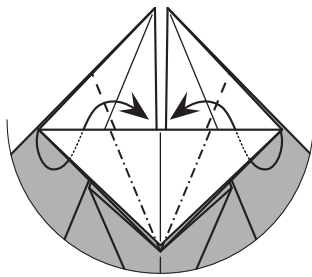

两侧内翻折

26

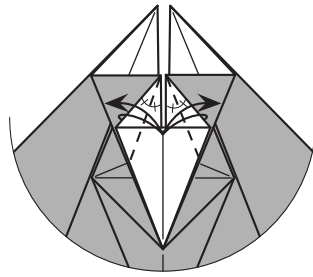

27

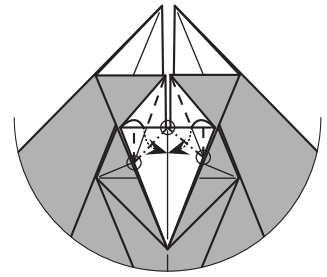

两侧向内旋转折

28

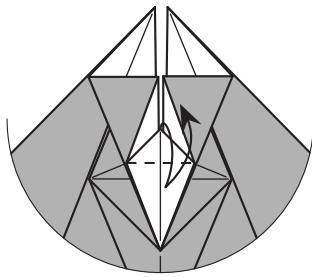

29

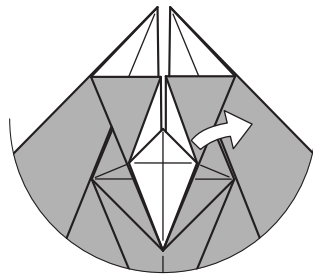

白色块拉至步骤30状

30

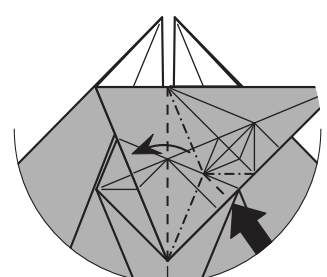

按照峰谷打开压平

31

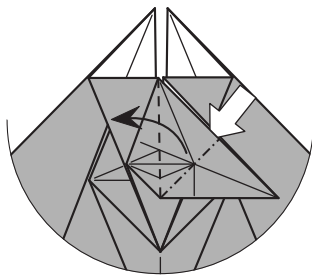

打开压平

32

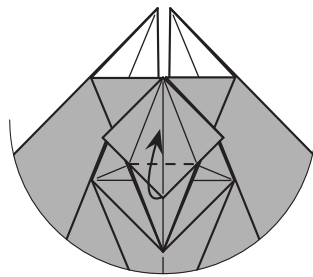

33

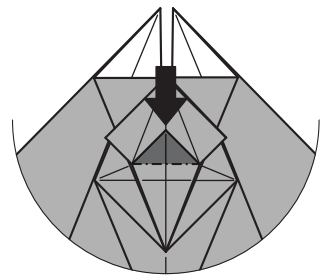

拉开后将阴影块引入内部

34

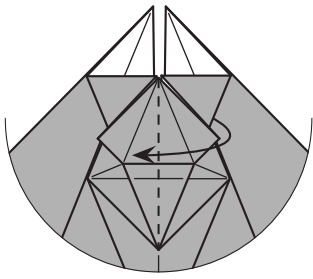

35

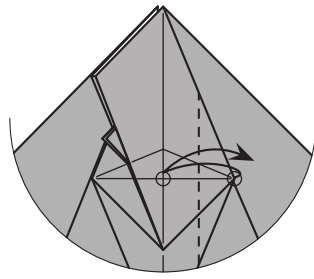

36

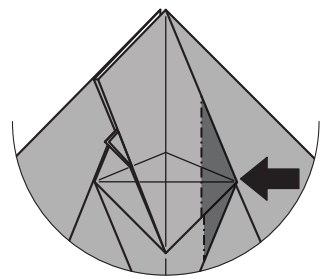

开放沉折

37

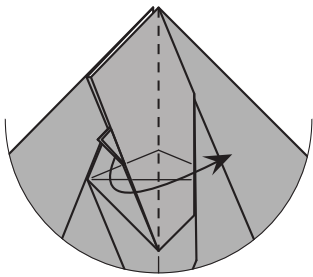

38

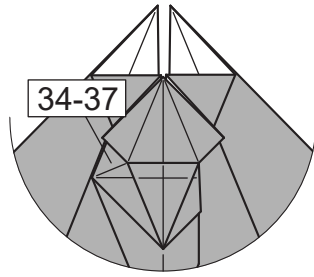

左侧重复步骤34-37

39

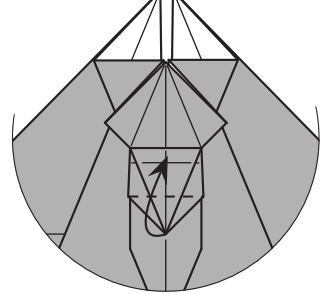

40

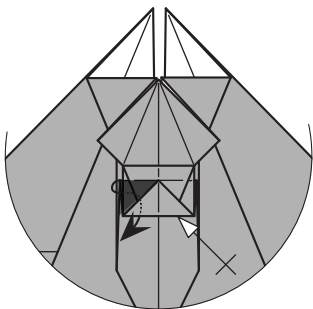

两侧内翻折

41

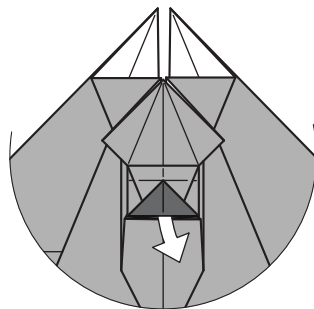

引出小三角

42

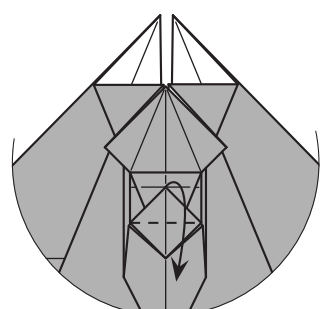

43

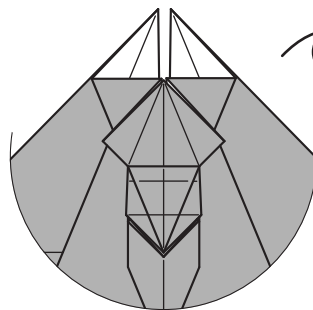

翻面，视角复原

44

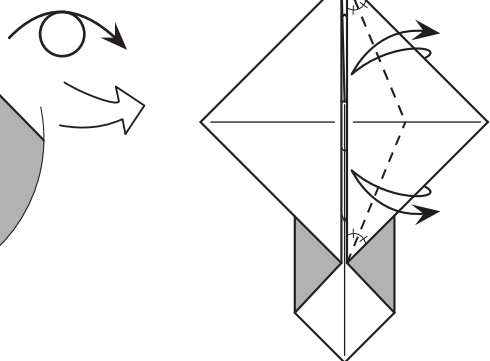

45

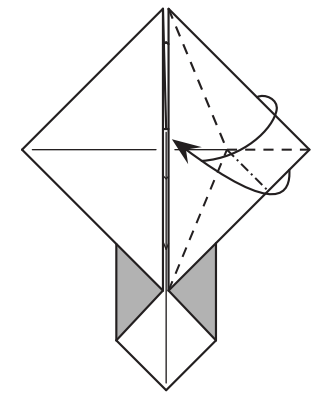

内翻折



46

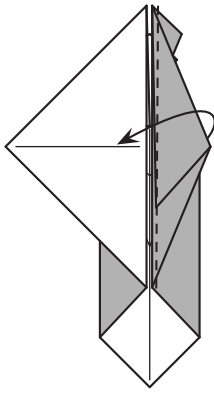

47

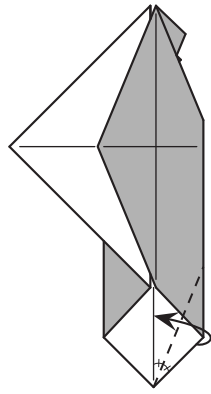

48

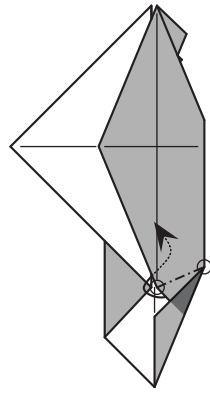

向内旋转段折

49

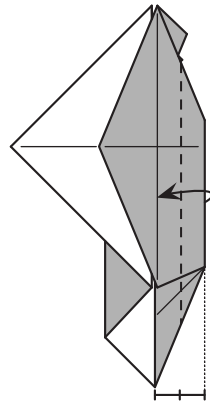

50

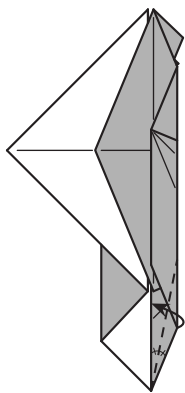

51

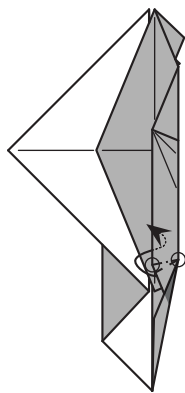

向内旋转段折

52

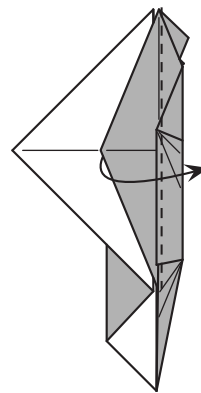

53

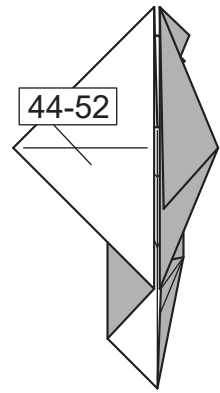

左侧重复步骤44-52

54

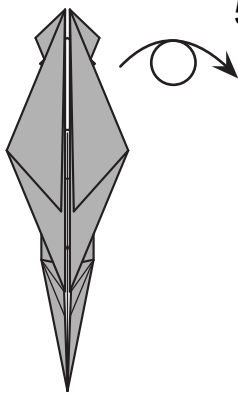

翻面

55

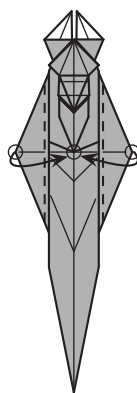

56

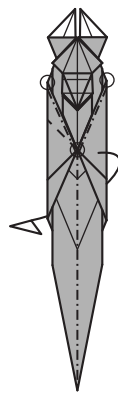

收细

57

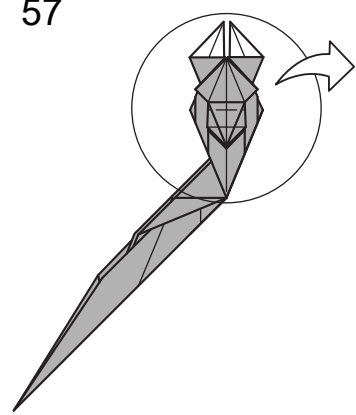

58

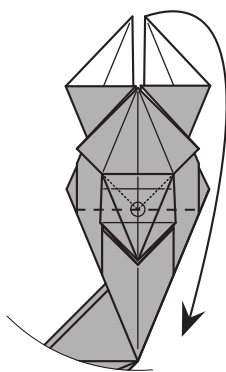

59

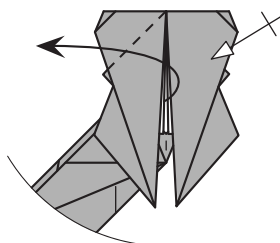

两侧打开

60

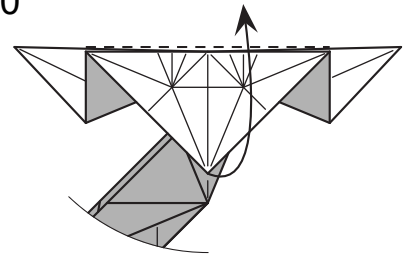

61

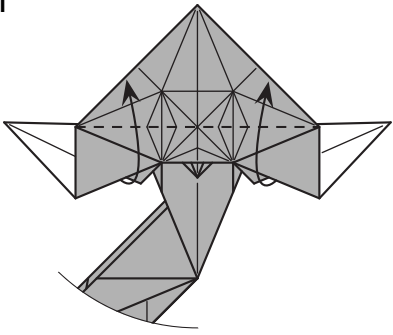

向上拉开压平

62

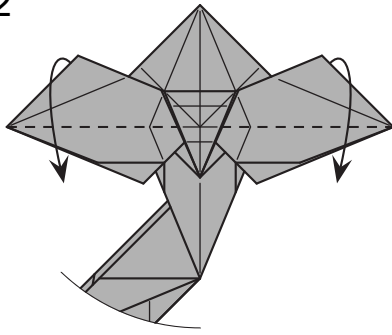

向下谷折

63

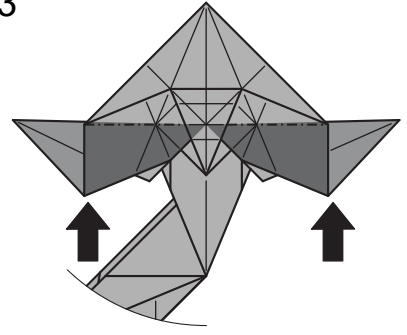

闭合沉折

64

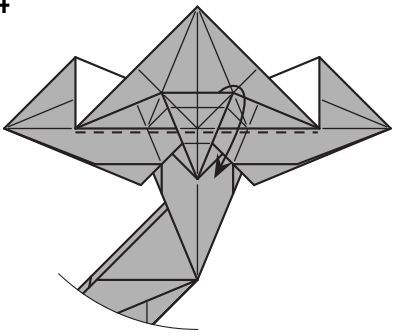

65

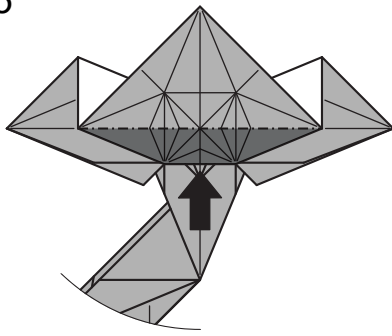

闭合沉折

66

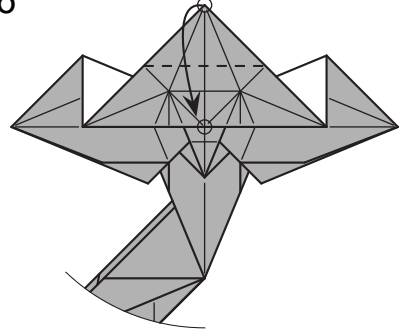

67

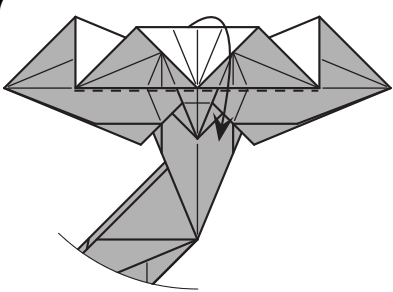

68

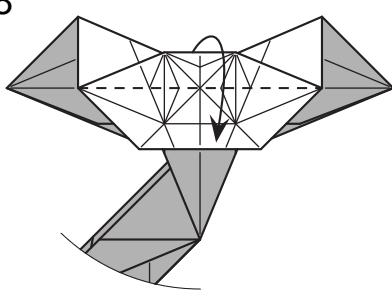

69

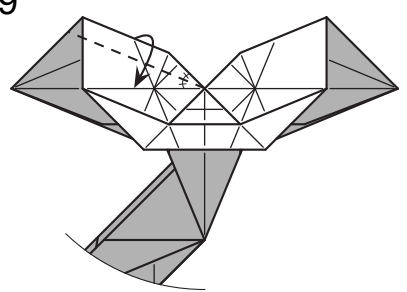

70

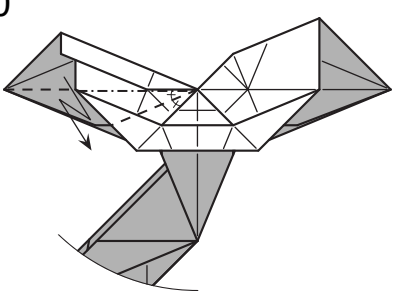

旋转段折压平

71

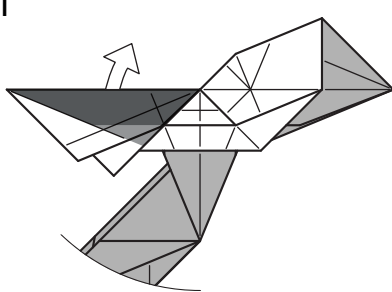

后侧引出两个纸层

72

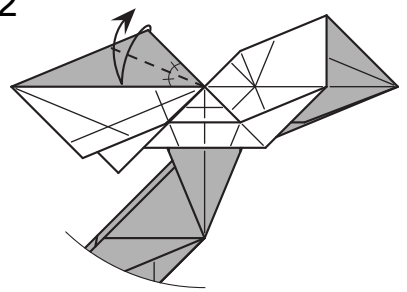

73

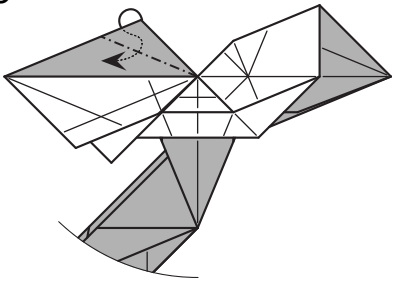

内翻折

74

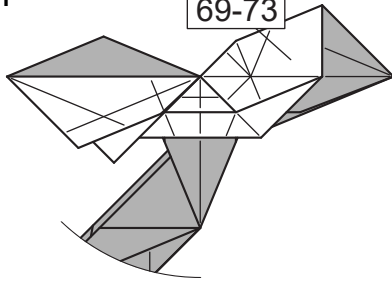

右侧重复步骤69-73

75

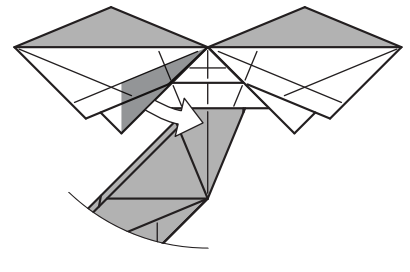

引出内部纸层

76

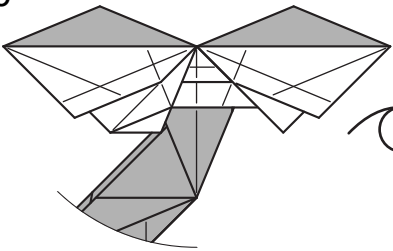

翻面

77

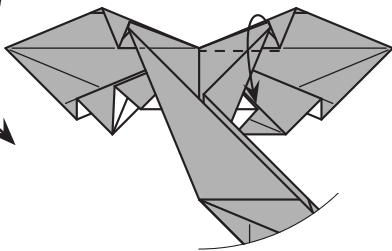

向下谷折一层

78

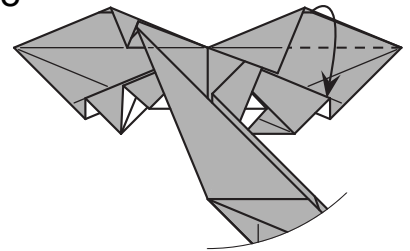

79

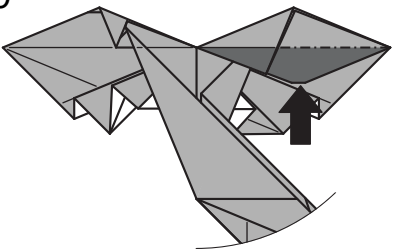

闭合沉折

80

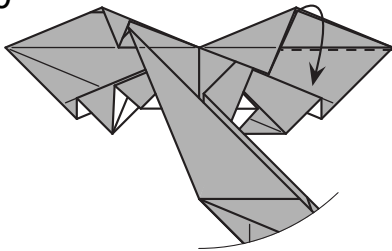

向下谷折一层

81

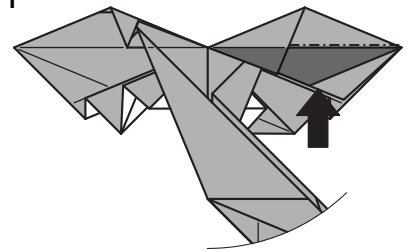

闭合沉折

82

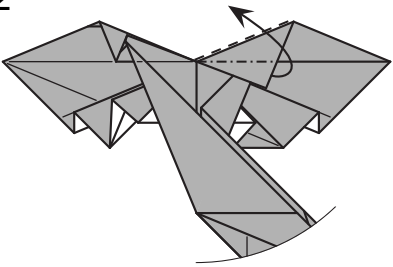

完全引出

83

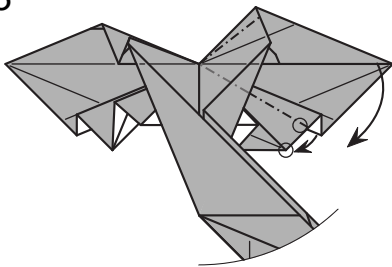

边对点旋转折叠

84

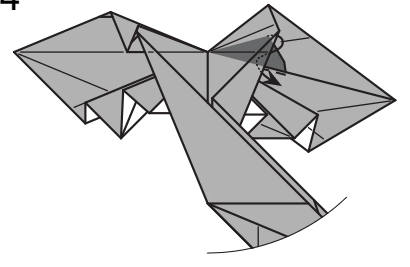

内翻折

85

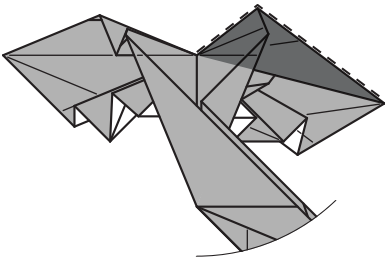

拉开翻双色

86

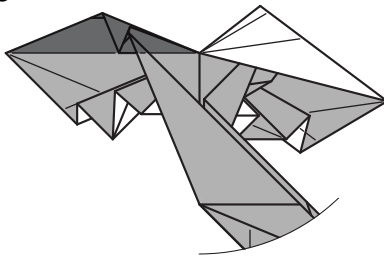

调整三个纸层位置，错开

87

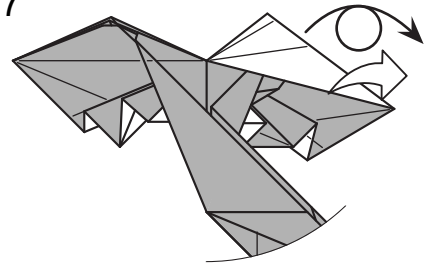

翻面，局部放大

88

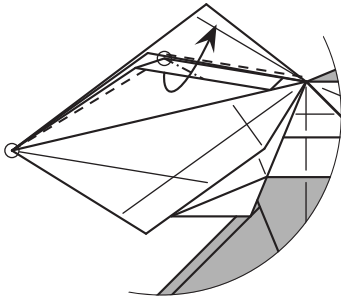

旋转折叠

89

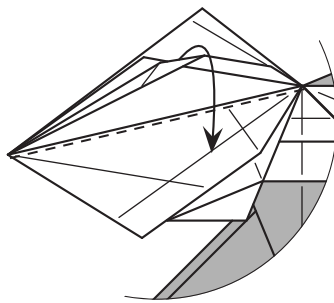

90

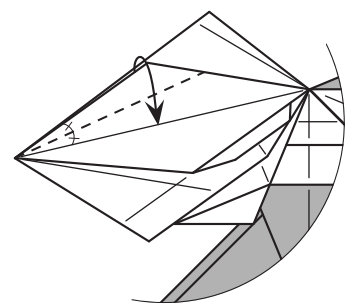

91

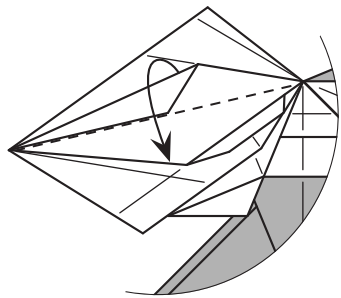

92

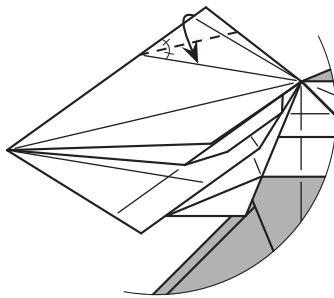

93

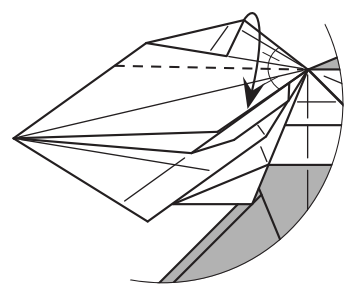

94

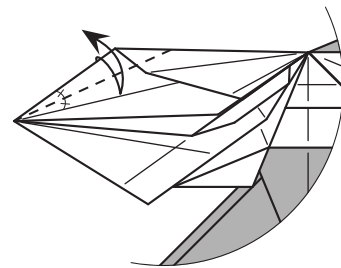

95

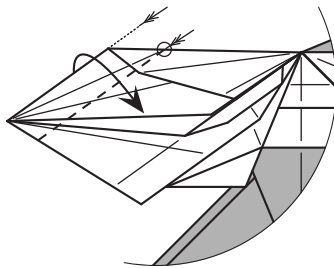

与边缘平行谷折

96

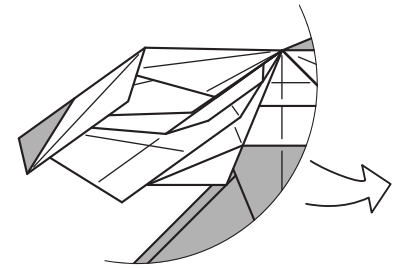

视图复原

97

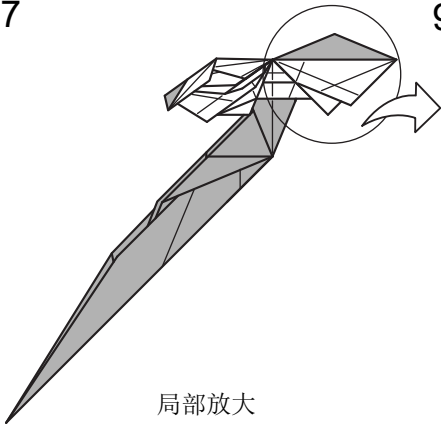

局部放大

98

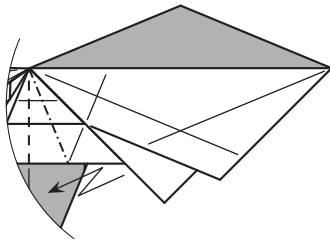

段折

99

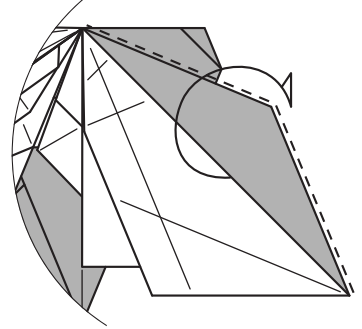

翻双色

100

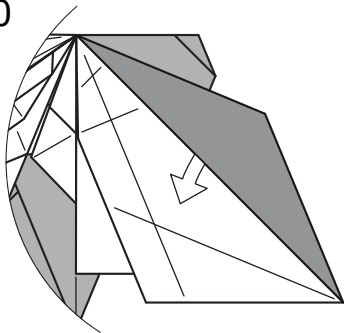

引出最上面的纸层

101

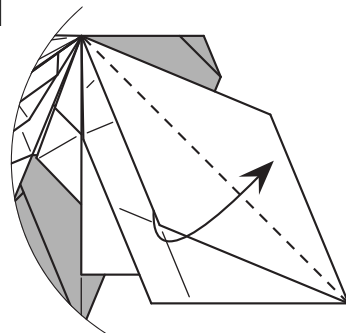

102

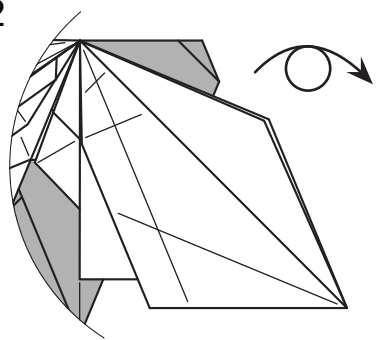

翻面

103

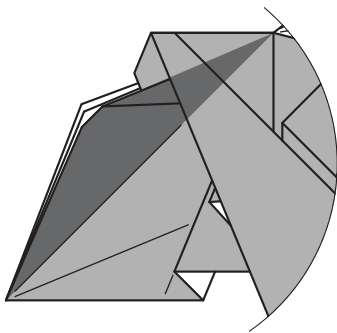

藏至内部纸层中

104

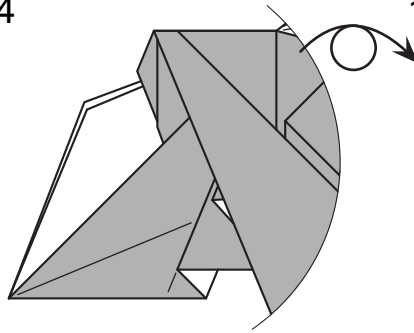

翻面

105

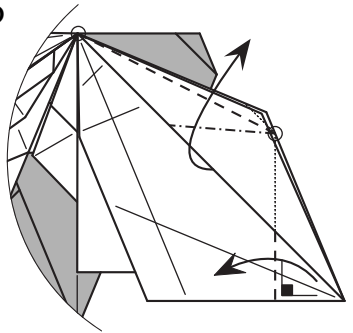

旋转折叠，注意中心在隐藏的纸层上

106

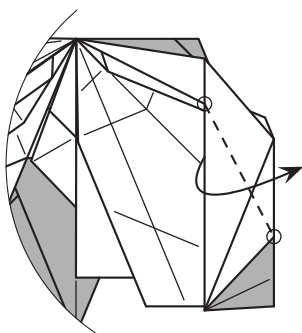

打开

107

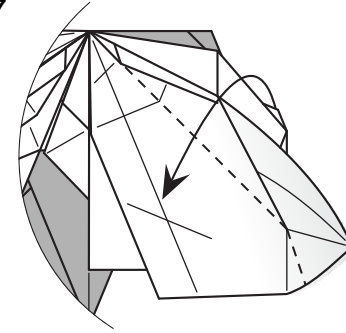

压平

108

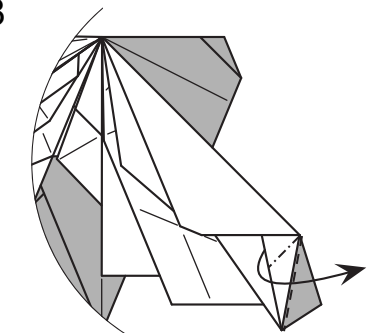

旋转拉开

109

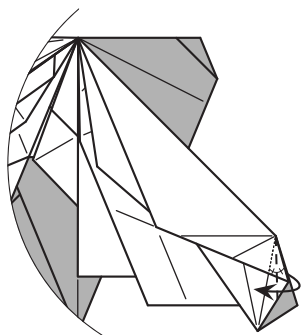

110

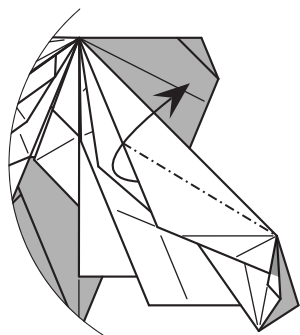

旋转引出内部纸层

111

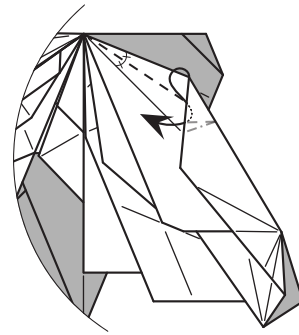

内侧一层旋转折叠

112

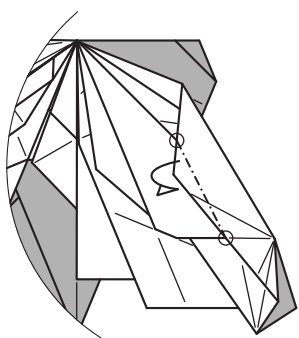

113

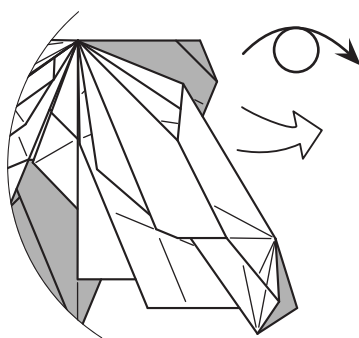

翻面，视图缩小

114

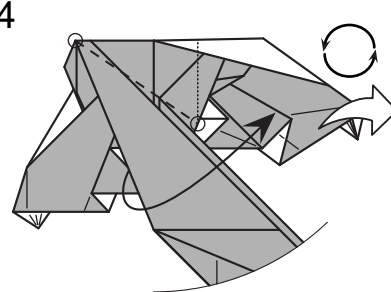

按照步骤36的点谷折

115

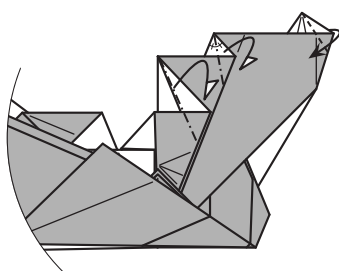

116

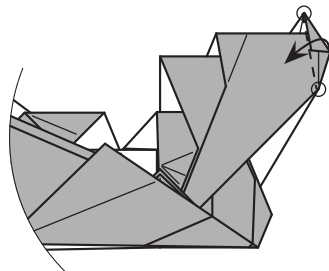

117

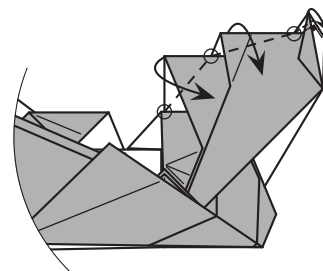

118

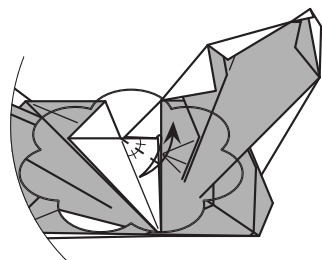

透视视角

119

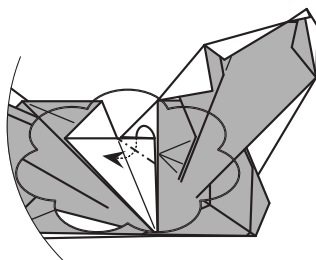

内翻折

120

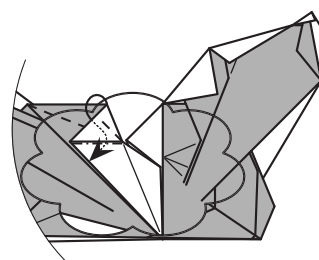

向内旋转折叠

121

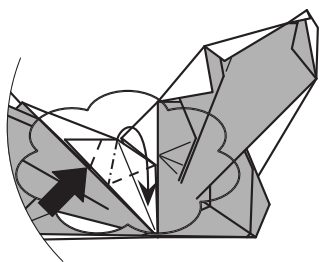

向下折叠，侧面压入

122

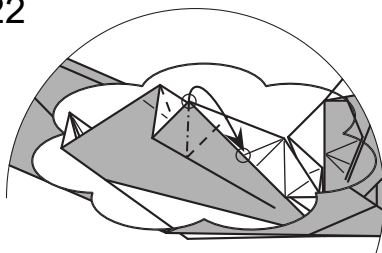

点对点，旋转折叠

123

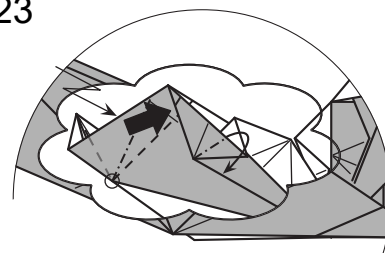

复杂的旋转折叠

124

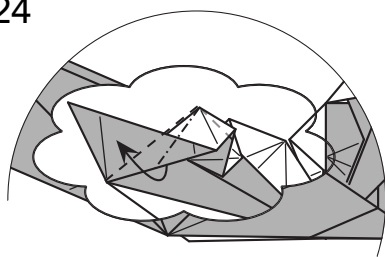

旋转折叠

125

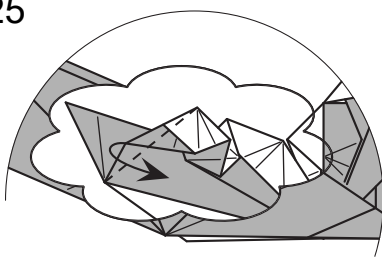

126

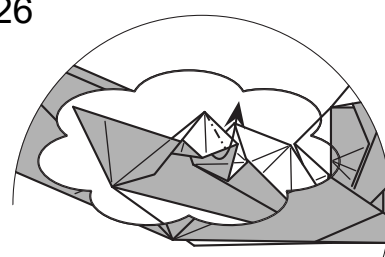

旋转拉出纸层

127

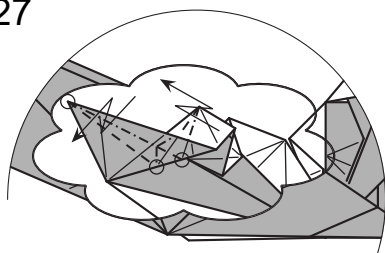

段折压平

128

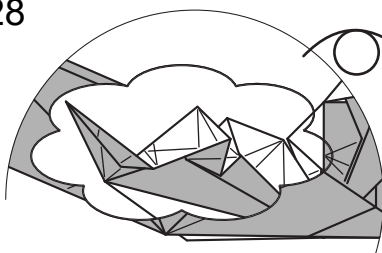

翻面

129

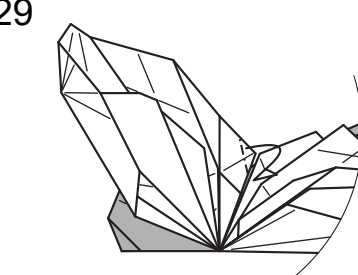

130

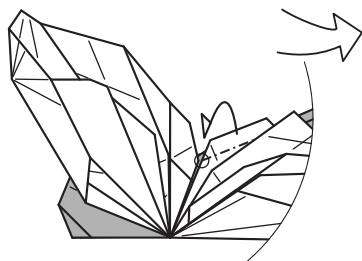

向后折，视角复原

131

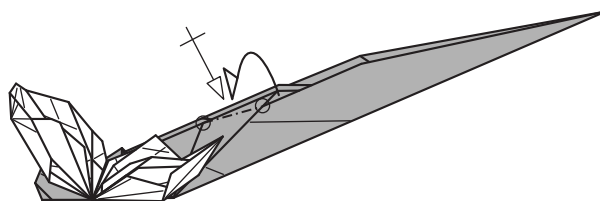

132

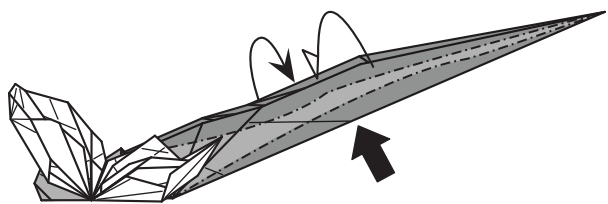

立体整形

133

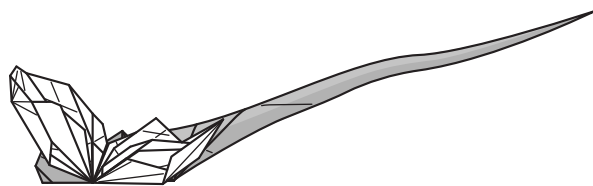

完成!





芙  
蝶



# 芙蝶

设计/Designer: eR  
 图示/Diagramer: eR/3k

推荐用纸/Paper :  
 - 教育折纸 35x35 cm

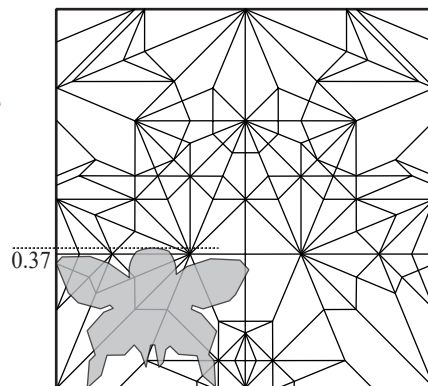

1

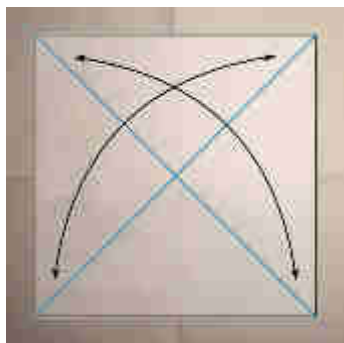

2

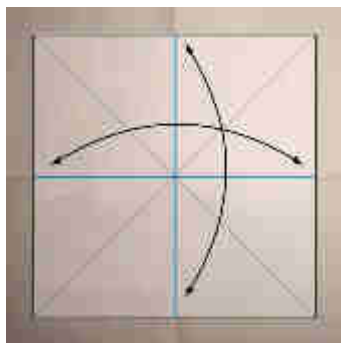

3

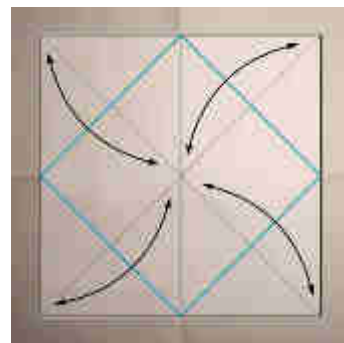

4

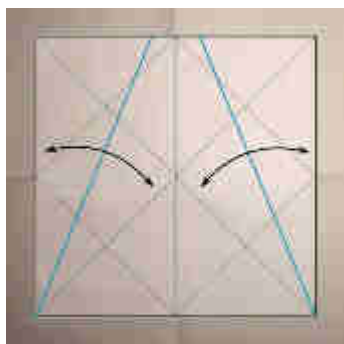

折出角平分线

5

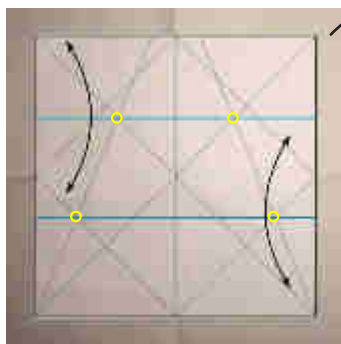

连接两点折出折痕，翻面

6

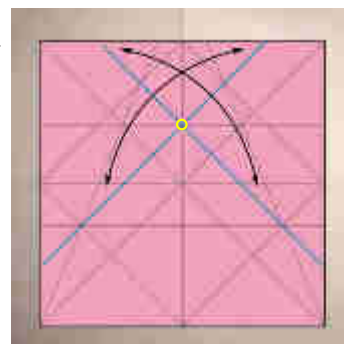

7

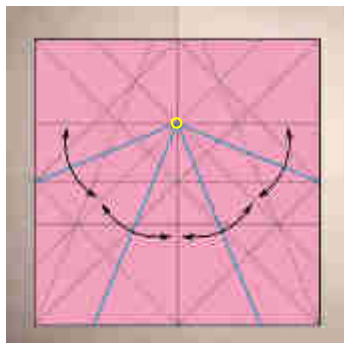

折出角平分线

8

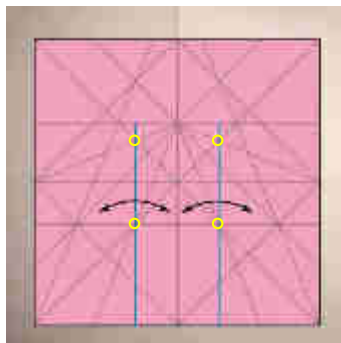

连接两点折出垂直线

9

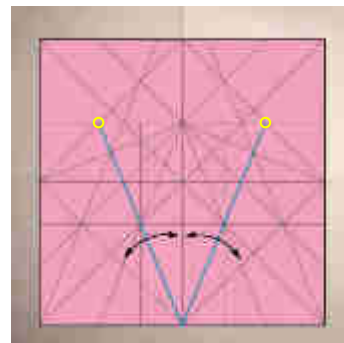

折出角平分线

10

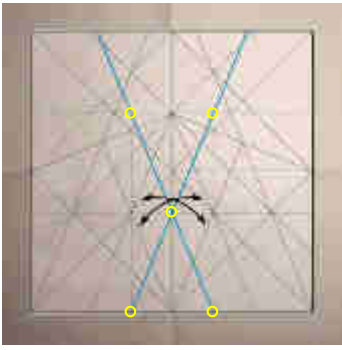

11

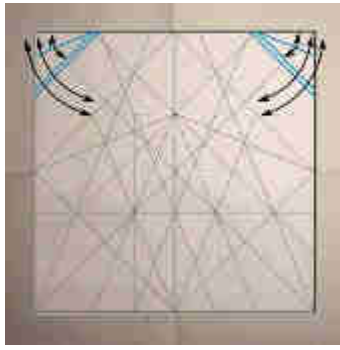

12

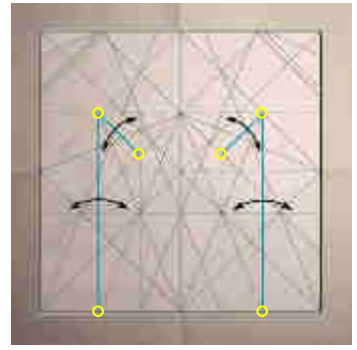

13

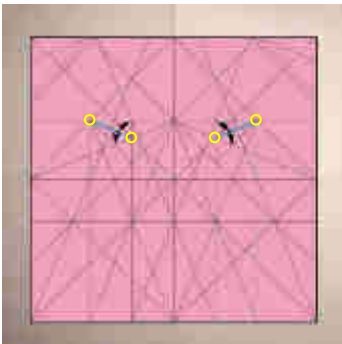

14

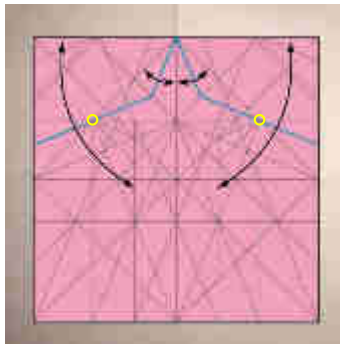

折出角平分线

15



16

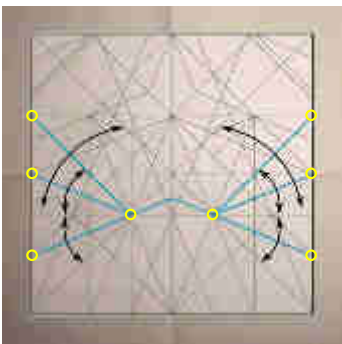

折出角平分线

17

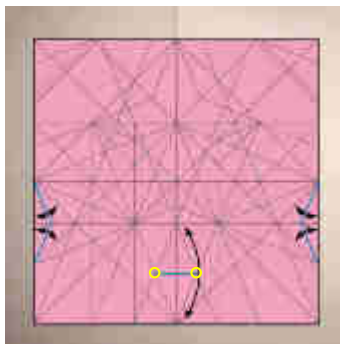

18

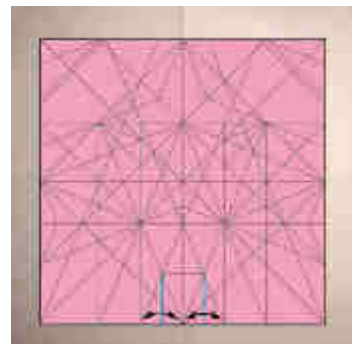

19

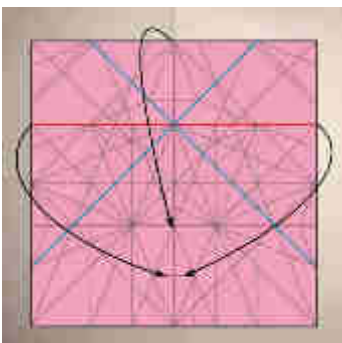

红峰蓝谷向下压

20

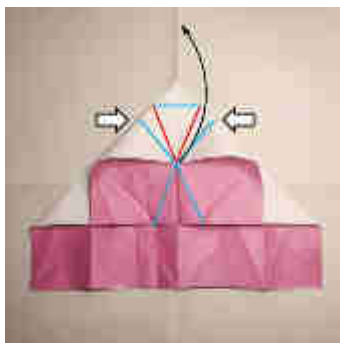

向上花瓣折，两边压平

21

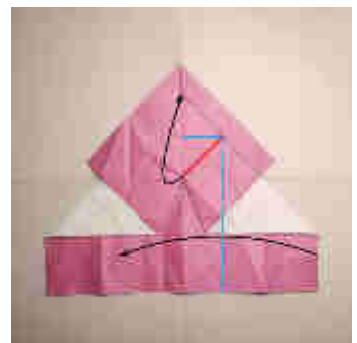

打开向上旋转折，  
右边向左折

22

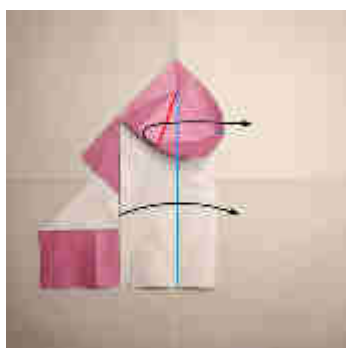

旋转折压平

23



左侧重复步骤21-22

24



翻面

25

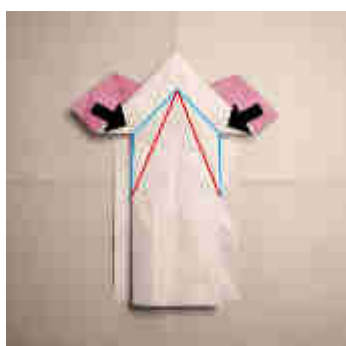

开放沉折

26



27

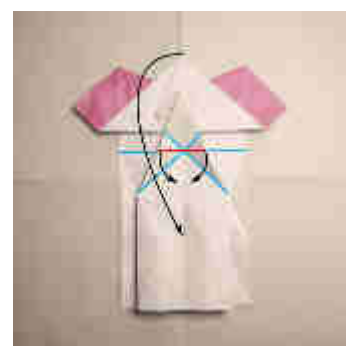

28



拉开成立体状，翻面参考下一步

29



按峰谷聚合

30



翻面

31



32



翻面

33



中间打开，向上压平

34

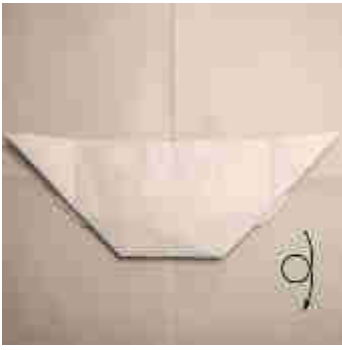

翻面并旋转180°

35

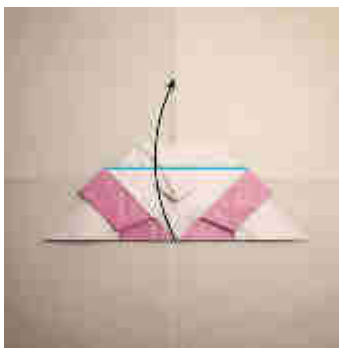

36

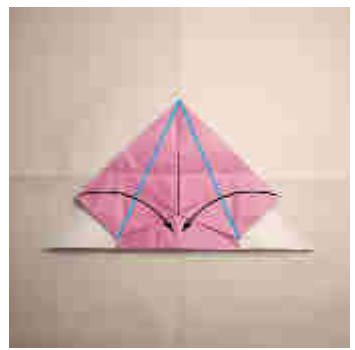

37

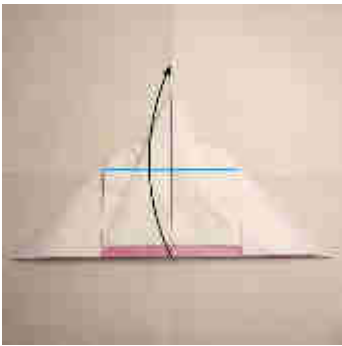

38



旋转折叠

39



旋转，变立体

40

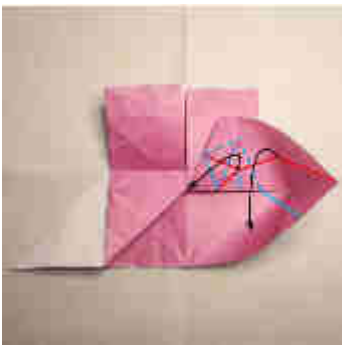

按照峰谷压平

41



向内旋转折

42



43



双向段折

44



翻面

45

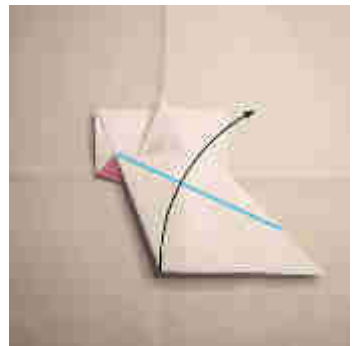

46



分层折叠，右上图标注  
为第一层峰谷，大图为下层峰谷

47



此图为内部纸层状态

48



右侧重复步骤38-46

49



50

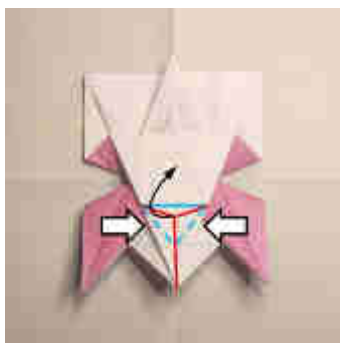

将中间拉起

51



52



打开压平

53



引出内部纸层

54



右侧重复步骤53

55



三角形纸层藏至内层

56



翻面

57



将颜色纸层翻上去



58



向左旋转压平

59



内翻折

60



左侧重复步骤58-59

61



引出内部纸层

62



打开压平

63



花瓣折

64

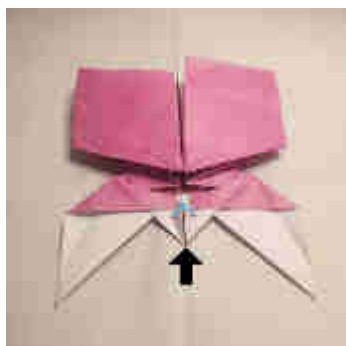

三角形纸层藏至内层

65



按峰谷折叠，注意参考下一步

66

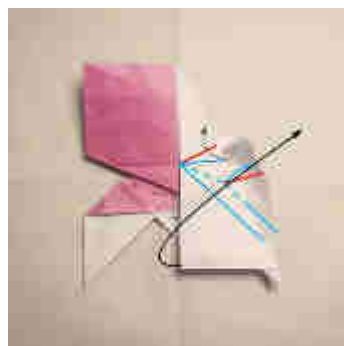

分层折叠，第二层的操作是第65步的折法

67



翻面

68



引出内部纸层

69



向后折叠



70

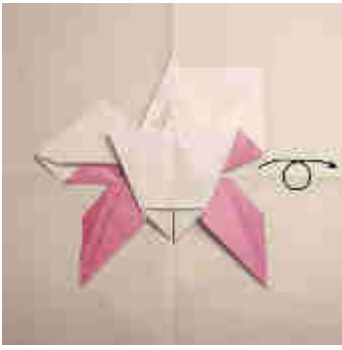

翻面

71



72



拉开纸层

73



顶出尖角

74



兔耳折

75



左侧重复步骤65-74

76



翻面

77



78



段折向下压平

79



向后折叠

80

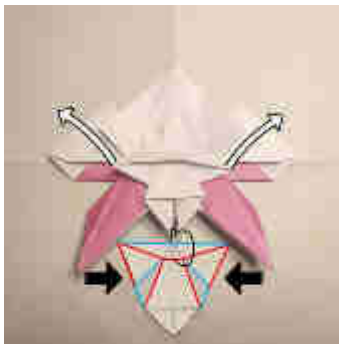

打开至77步的状态，下方为峰谷图，把上面纸层折到后面

81

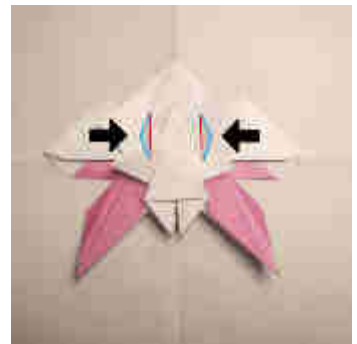

开放沉折

82



83



84

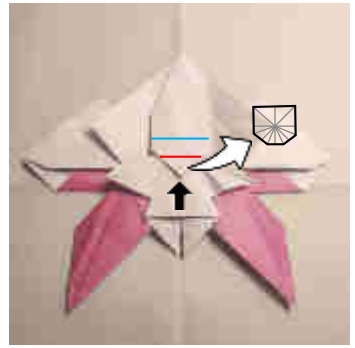

延展沉折, 红色线以下如图所示

85



86



87



左上角向右下角折叠, 红线处向后旋转折

88



89



段折

90



引出一个点, 纸层拉开

91



引出一个点, 压平

92



左侧重复步骤89-91

93

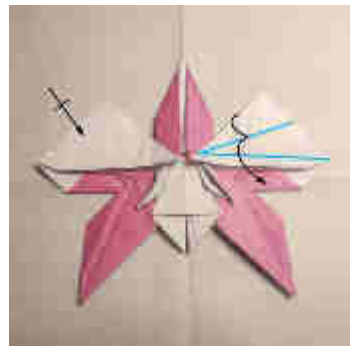

连续谷折, 左侧重复

94

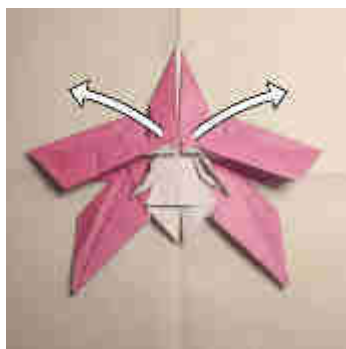

打开

95



96



97



打开，左侧重复

98



99

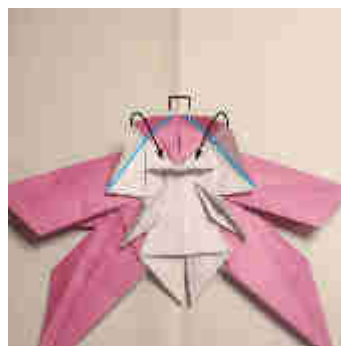

注意留一点距离

100



折出头发

101



102

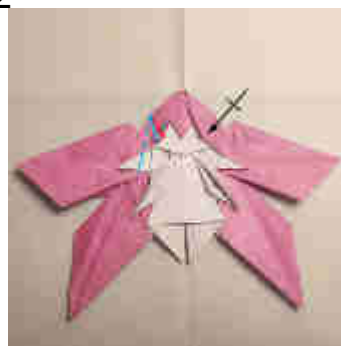

103



104



105



106



向内旋转折

107



段折腿部，变立体

108



翻面

109



接下来，左侧为最终效果，对右侧进行折叠

110

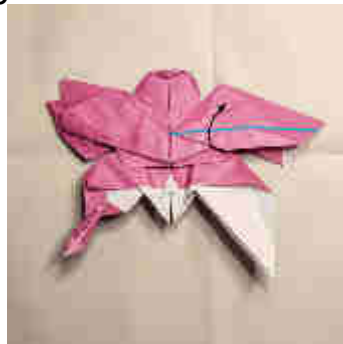

111



引出内部纸层

112

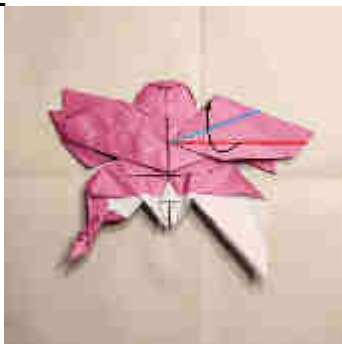

段折打开

113



段折向下压平

114



引出一个点，翅膀处变立体

115



翻面

116



立体部分向后压平

117



兔耳折，折出翅膀的翅尾

118



撑开压平

119



修翅膀

120



手部参考成品修型

121



右侧重复步骤110-120，  
完成！

梁  
祝





# 梁祝

设计/Designer: 子游君  
图示/Diagramer: 子游君

推荐用纸/Paper :  
- 教育折纸 50x50 cm

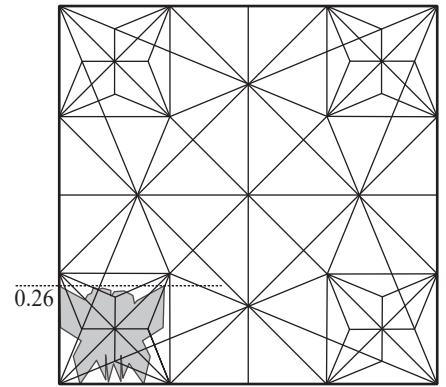

1

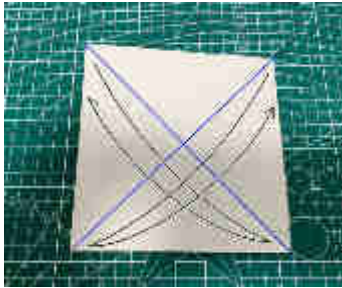

2

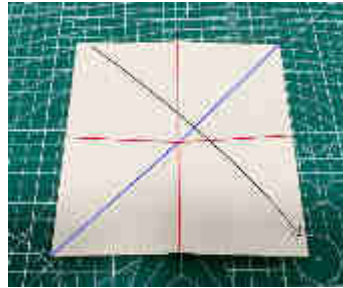

双正方形基本型，  
白面朝上

3

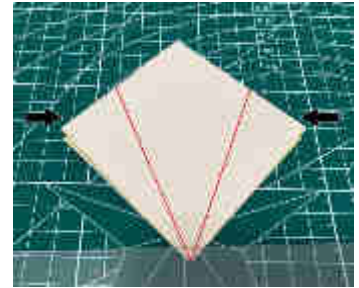

两边内翻折

4



后侧重复

5

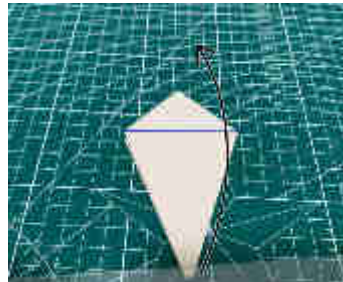

6



7



引出内侧纸层

8

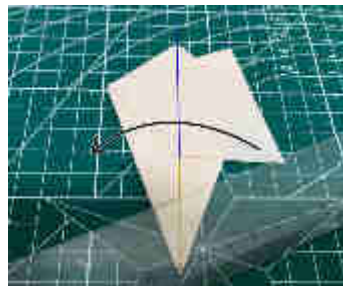

9



引出内侧纸层

10



11



12



复原至步骤10

13



14

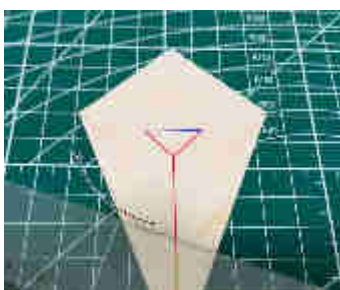

15

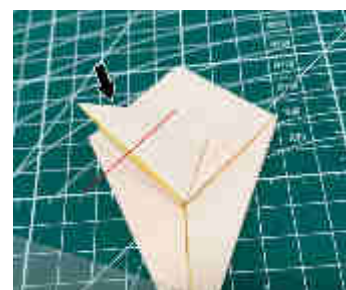

16



17



18



19



其余三边重复

20



八等分

21



多段开放沉折



22

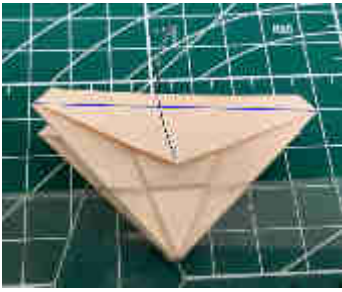

23

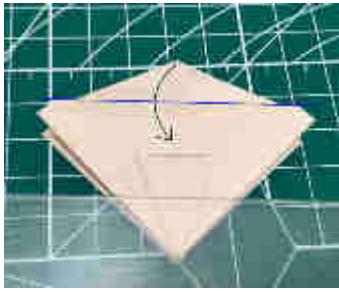

24

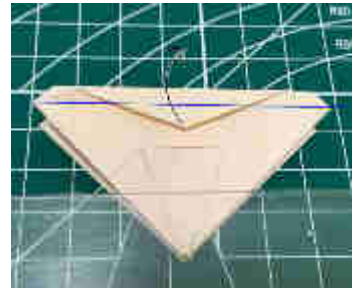

25



26

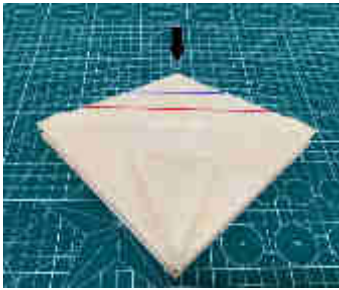

多段开放沉折

27



翻面

28



重复步骤23-26

29

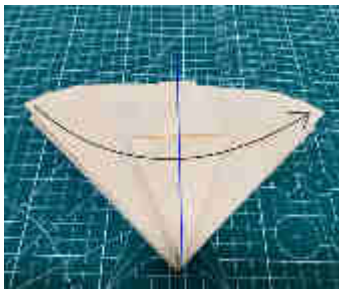

30



引出纸层

31



禁术，可以将阴影处折到里面隐藏，或者剪掉

32

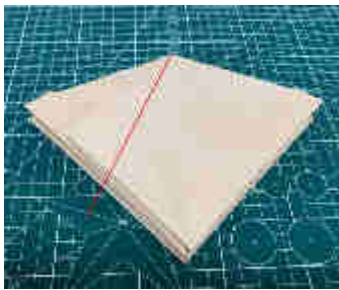

33

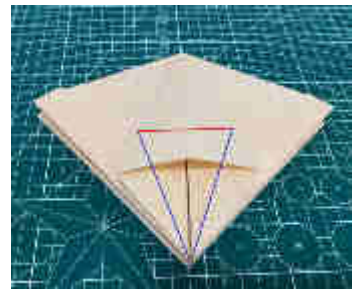

旋转塞进内部

34



35



36



37



开放沉折

38



后侧重复步骤30-37

39



40



41



42



闭合沉折

43



44



45





46



47



48



复原成39步的样子

49



背面重复39-48步

50



51



52



53



同42-47步

54



复原成第51步的样子

55



56



57



58



59



60



61



62



63

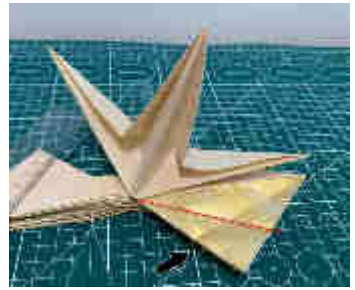

64

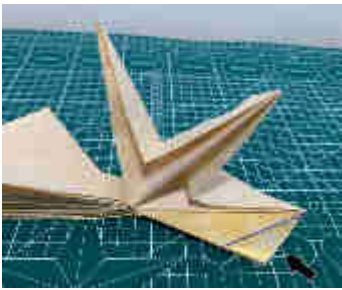

65



66



另一側重复第64步

67

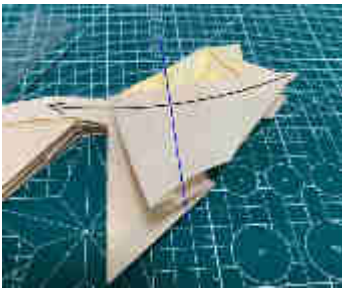

68



69





70



右侧身体完成啦~

71



72



延展沉折

73



引出内侧三角

74



75



同72-73步

76



77



78

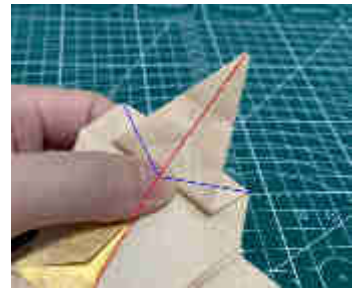

79

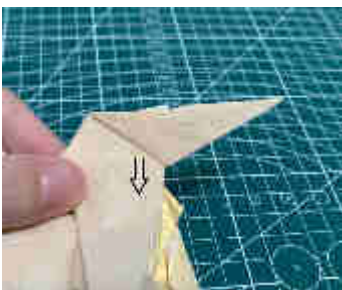

引出第一层

80

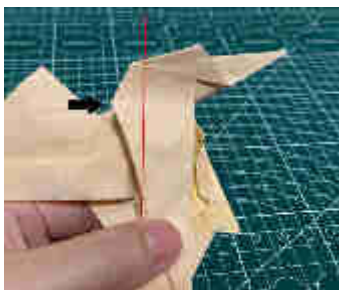

开放沉折

81



另一侧重复79-80

82



83

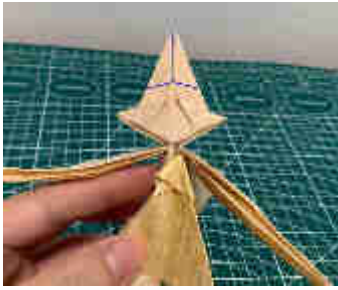

84



85

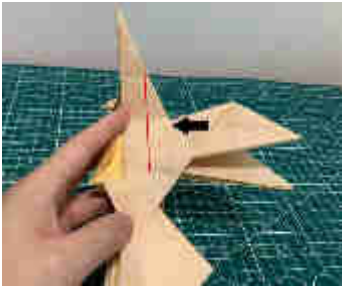

开放沉折

86



87

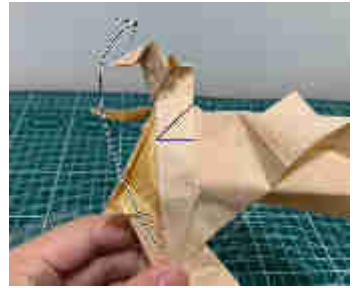

88

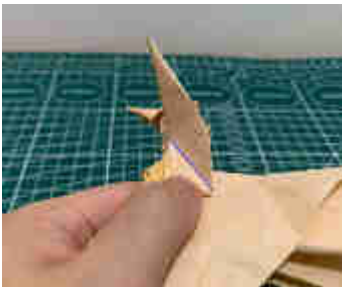

89

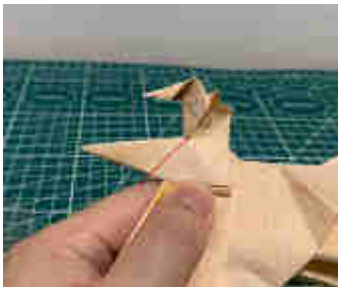

90



另一侧重复85-89

91



92



93



引出后侧纸层

94



95



96



97



98



99



100



101



102



103



104



105





106



107



同72-82步

108



109



110



111



左侧重复

112



113

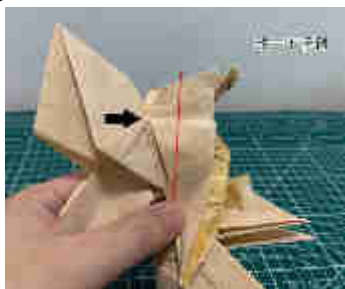

开放沉折

114



115



116



117





118

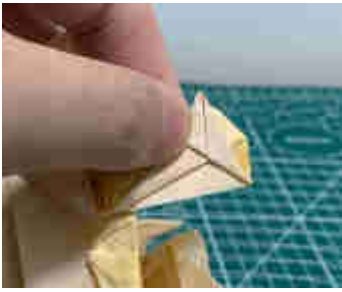

119



120



121



整形

122



背后

123



完成!



# 二尾

设计/Designer:XR  
 图示/Diagramer:XR

推荐用纸/Paper :  
 - 教育折纸 15x15 cm

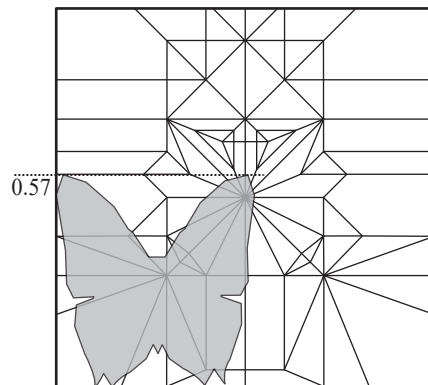

1

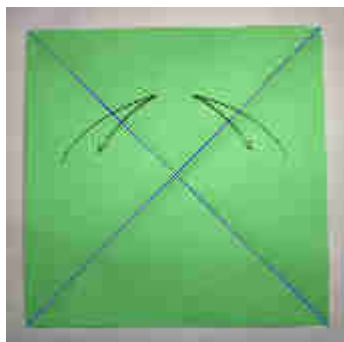

沿对角线预折

2

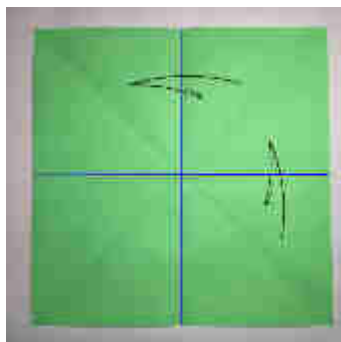

对边对齐预折

3

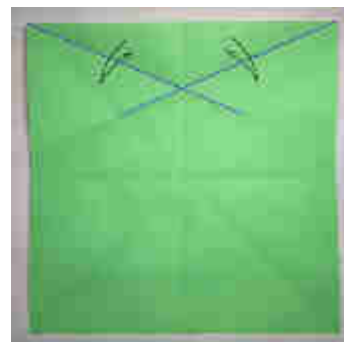

沿角平分线预折

4



过给定交点预折，与两侧边平行

5

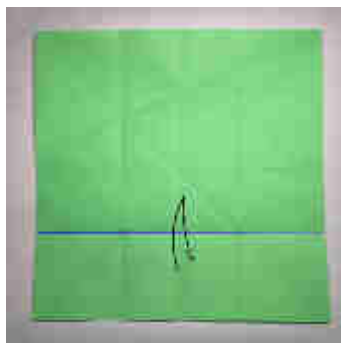

过给定交点预折

6

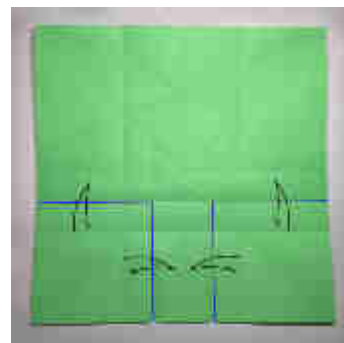

如图预折，将对应折痕对齐，

7

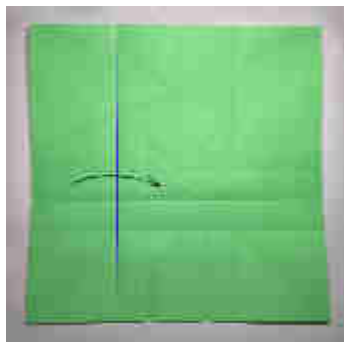

谷折

8



沿角平分线预折

9



打开

10

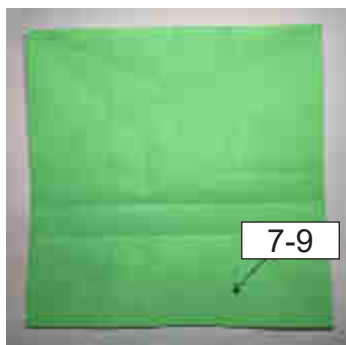

对侧重复步骤7-9

11



放大纸张下方局部

12

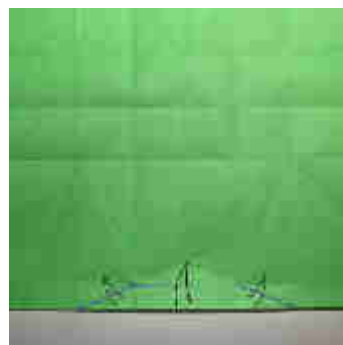

如图预折，注意参考点

13

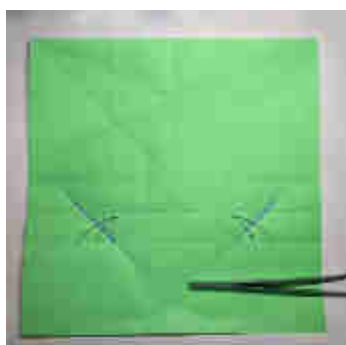

沿角平分线预折

14



过对应点预折平行于对角线的折痕

15

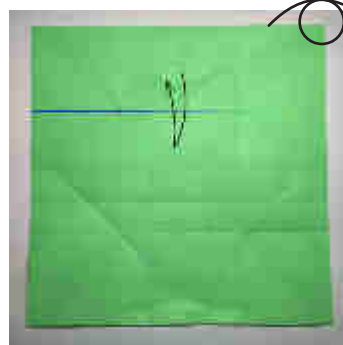

过给定交点预折，前后翻转

16



沿角平分线预折

17

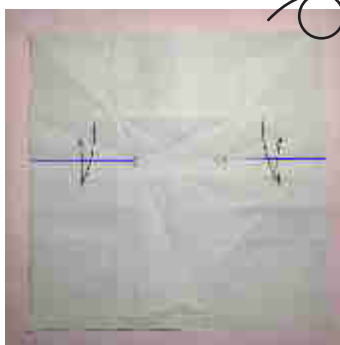

过给定交点预折  
水平线段，前后翻转

18



过给定交点预折斜向线段

19

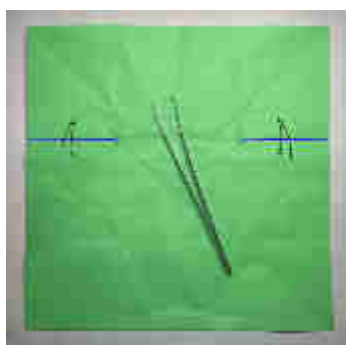

过给定交点预折水平线段

20



过给定交点预折斜向线段

21

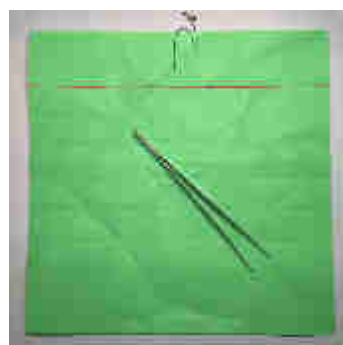

过给定交点预折水平线段

22



过给定交点预折  
水平线段，前后翻转

23



沿角平分线预折

24

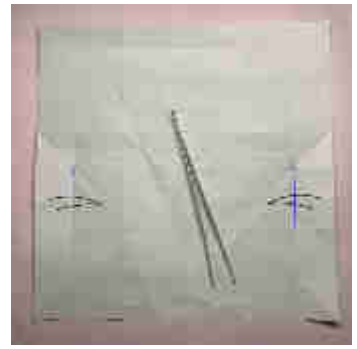

过给定交点预折  
竖直线段，前后翻转

25



放大纸张右侧局部

26



如图预折

27



沿角平分线预折

28



另一侧重复26-27

29



峰折，旋转模型

30

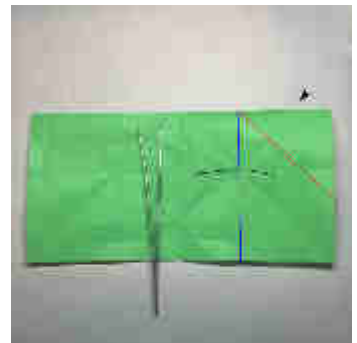

撑开，压平

31

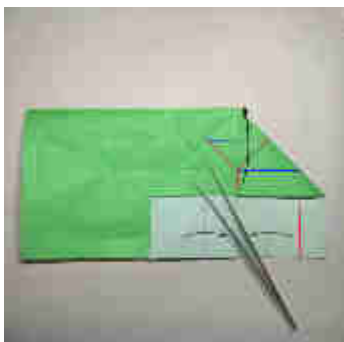

花瓣折

32



撑开，压平

33



前后翻转

34

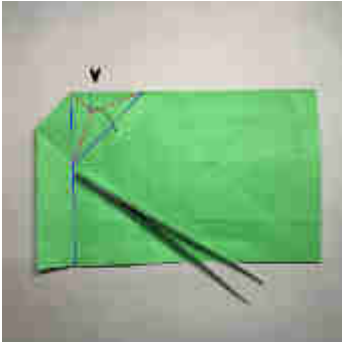

沿图示折痕折叠，模型背面进行同样的操作

35



谷折，背面纸层收在后方，模型将不能压平

36

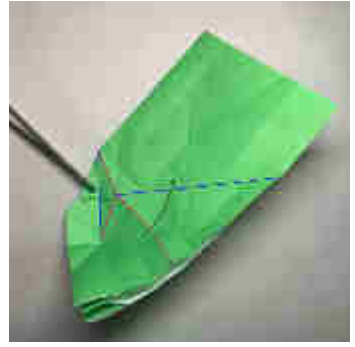

沿图示折痕折叠

37



如图折叠，将模型左侧局部压平

38



前后翻转

39



如浅蓝色阴影所示区域凸起，则小心将其向下压至凹陷

40



谷折

41



沿图示折痕折叠

42



如图折叠，整个模型将可以压平

43

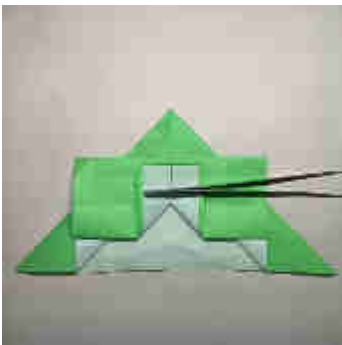

前后翻转

44

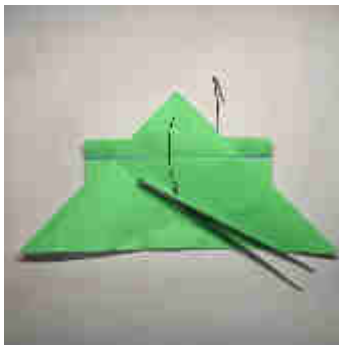

谷折，并将模型的部分结构翻转到上方

45

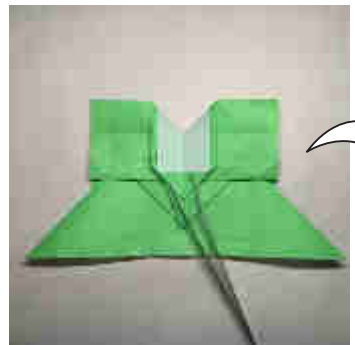

放大模型右侧局部

46

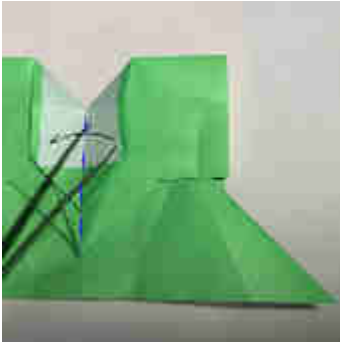

47



48

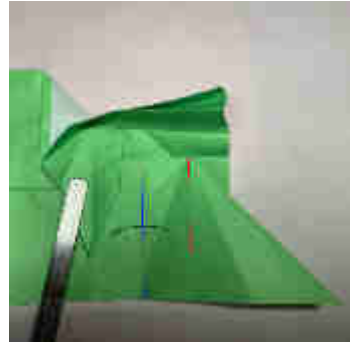

49



50



51



52



53



54



55



56



57





58



59



60

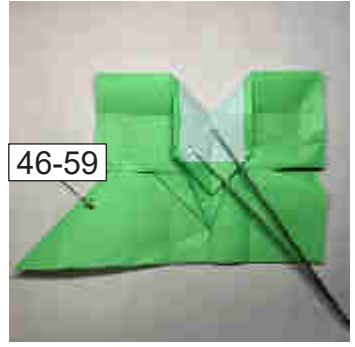

61

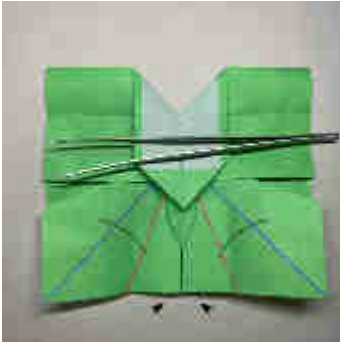

62



63



64



65



66



67



68



69





70



放大纸张右侧局部

71



向内翻折

72



前后翻转

73

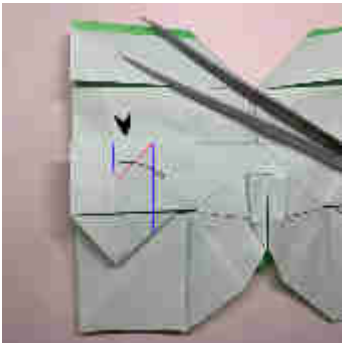

如图折叠，模型将无法压平

74



过程图，如图整理纸张

75



顺势压平，折痕由71, 73步骤唯一确定

76



谷折

77



前后翻转

78



另一侧重复步骤71-77

79



放大模型右上方局部

80

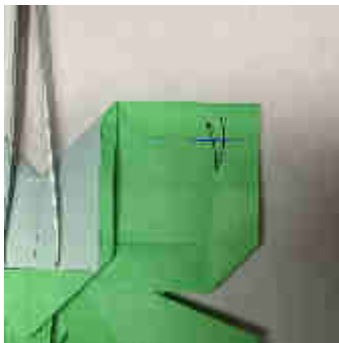

如图预折，前后翻转

81



如图将最外侧纸层向上拉，注意参考线与步骤80的预折的关系

82



前后翻转

83



如图旋转折叠，注意参考线与步骤80的预折的关系

84

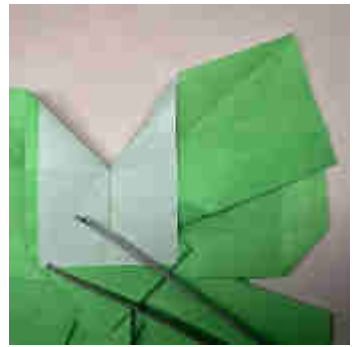

模型如图所示

85



步骤83处理后的翅基纸层关系

86



谷折

87



如图预折

88



沿蝴蝶身体右侧轮廓谷折

89



如图谷折，对齐体轴折痕

90



如图谷折

91



恢复至步骤88的状态

92

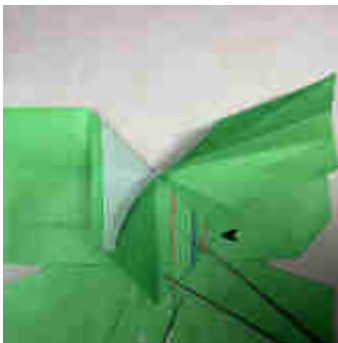

沉折，局部闭合

93



沉折过程图，注意纸层关系

94

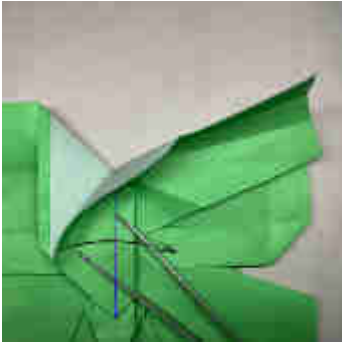

谷折

95

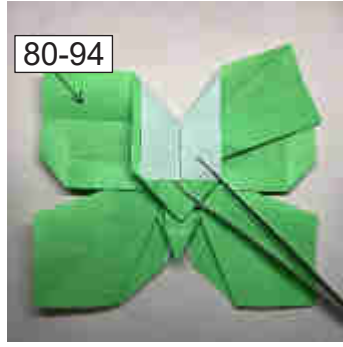

另一侧重复80-94

96

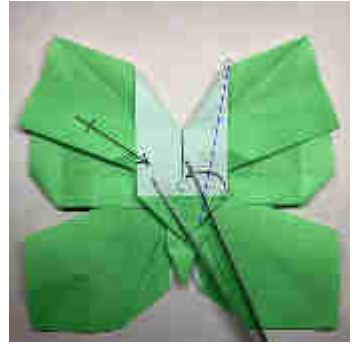

如图谷折，另一侧重复

97



谷折

98



放大模型中部身体局部

99

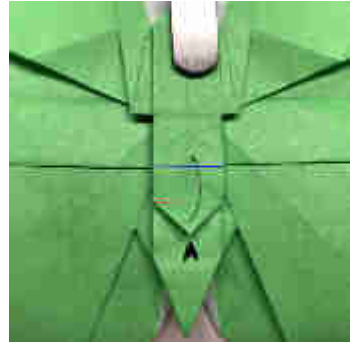

如图延展沉折

100

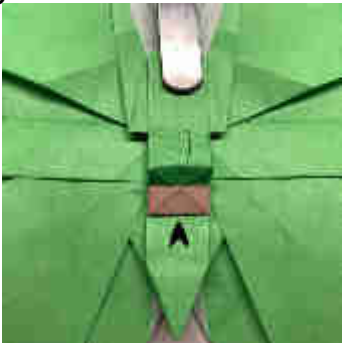

如图折叠，将红色结构压入模型

101



过程图

102



侧面纸层结构示意图

103

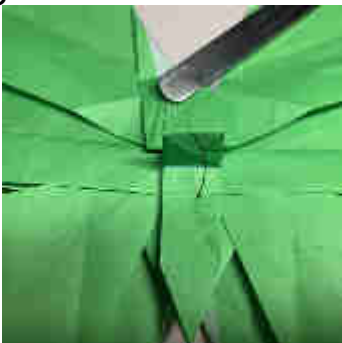

谷折

104

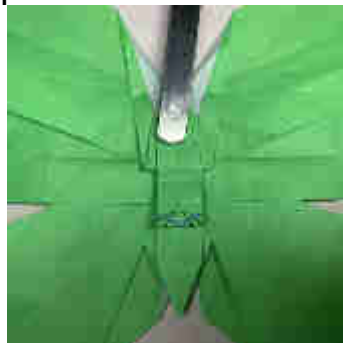

如图预折

105

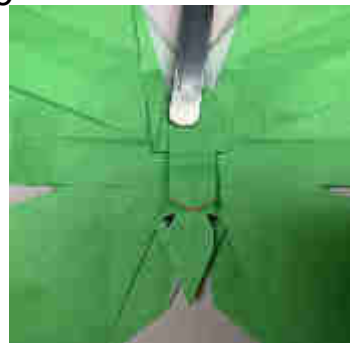

闭合沉折

106



身体结构如图所示

107

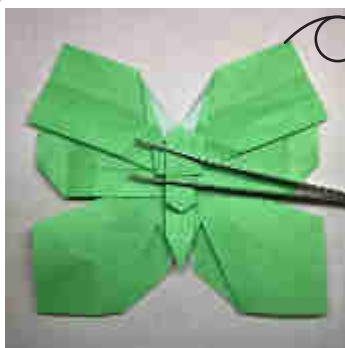

前后翻转

108



如图谷折, 另一侧重复

109



如图谷折, 另一侧重复

110



如图所示, 谷折整理翅形

111



前后翻转

112



沿角平分线峰折

113



如图预折, 无标准参考线, 注意两侧折痕对称

114



如图段折, 前后翻转

115



拉出外侧被段折收入的纸层, 后翅尾突旋转折叠, 另一侧重复

116



两侧前翅下端谷折

117



前后翻转

118



谷折

119



如图谷折

120



谷折将纸层收入

121



谷折

122



整体形态进行微调

123



完成!



精  
灵



# 精灵

设计/Designer: 陈晓 (Ob)

推荐用纸/Paper :  
- 教育折纸 60x60 cm

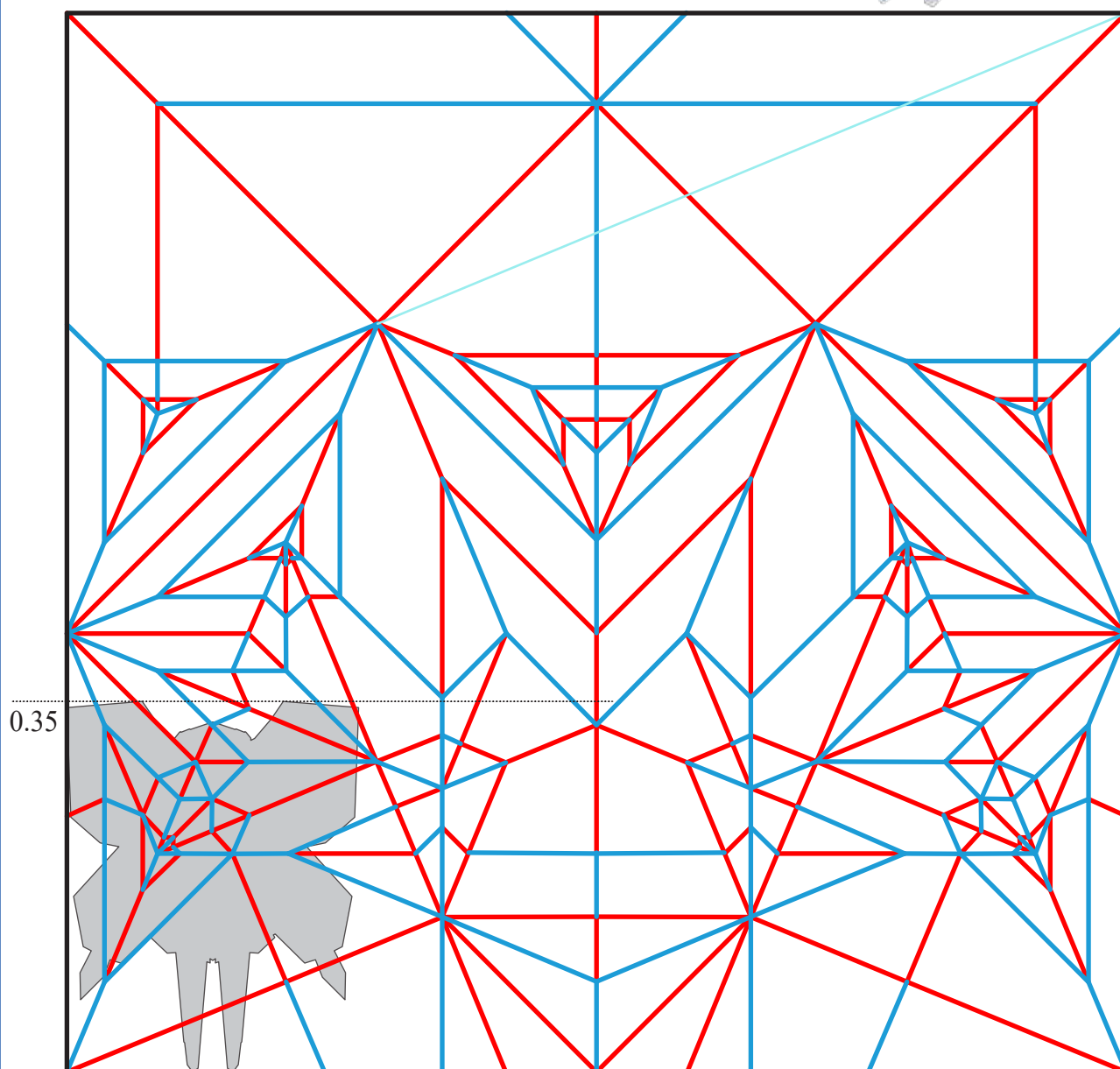



# 整形参考





繖

綉



# 缙卷

设计/Designer: 骆昱超 (活宝小骆)

推荐用纸/Paper :  
- 教育折纸 35x35 cm

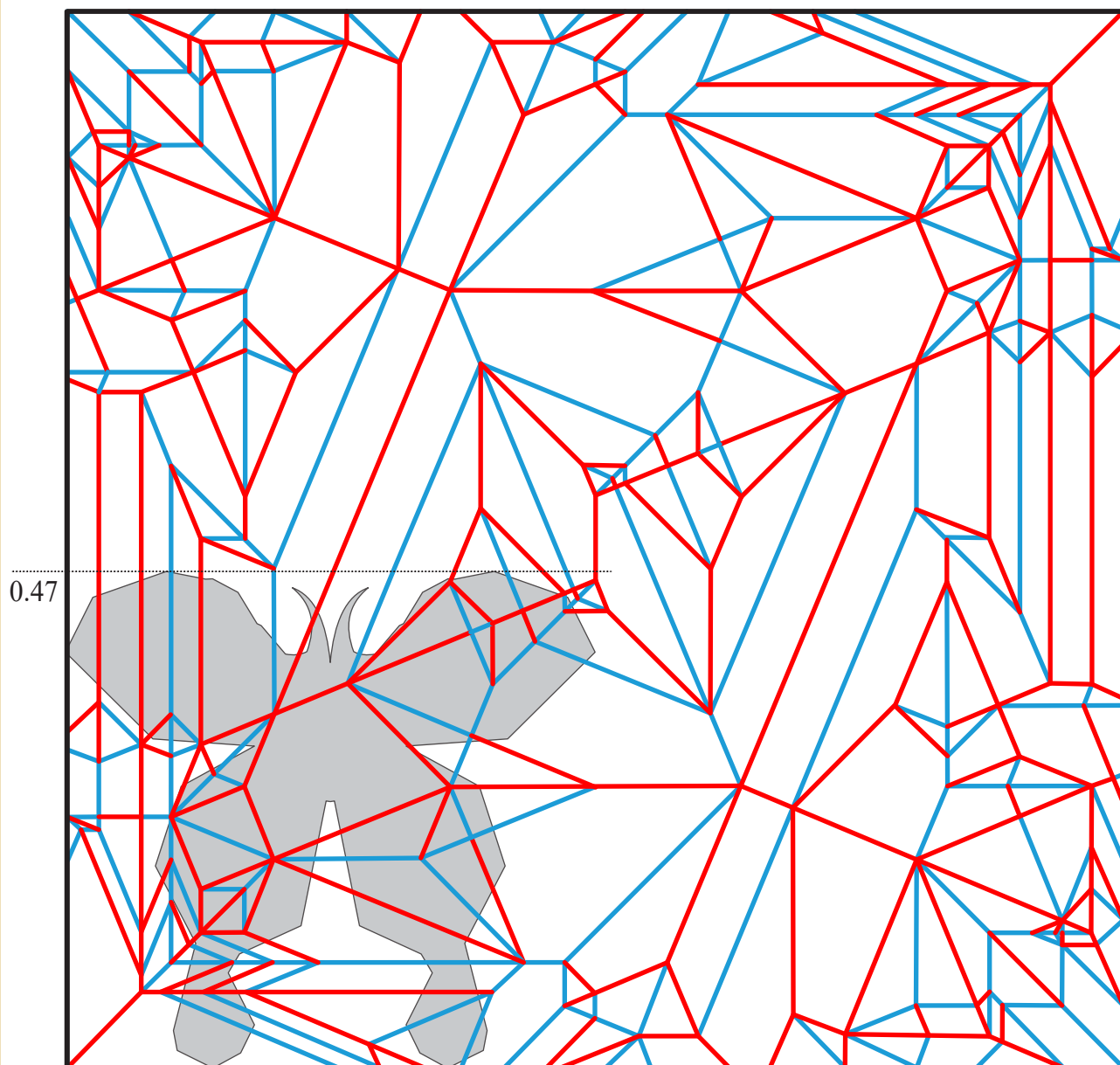

# 打线参考

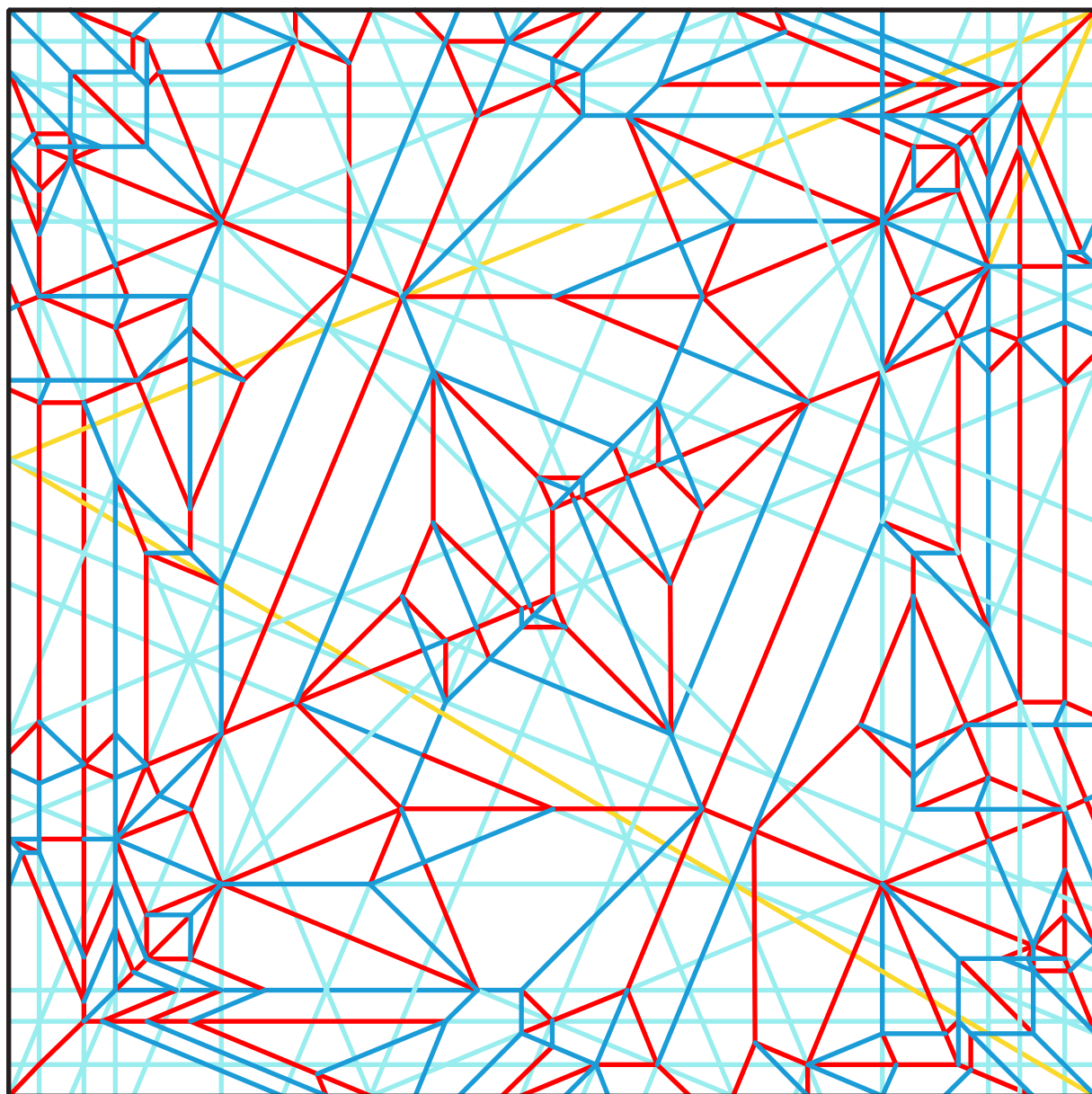
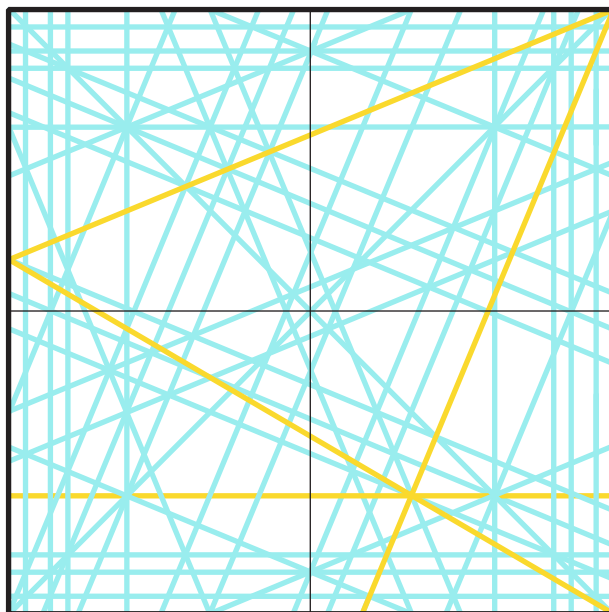

# 整形参考



鼠  
鼠  
夢  
蝶





# 鼠鼠梦蝶

设计/Designer: 系统

推荐用纸/Paper :  
- 教育折纸 20x20 cm

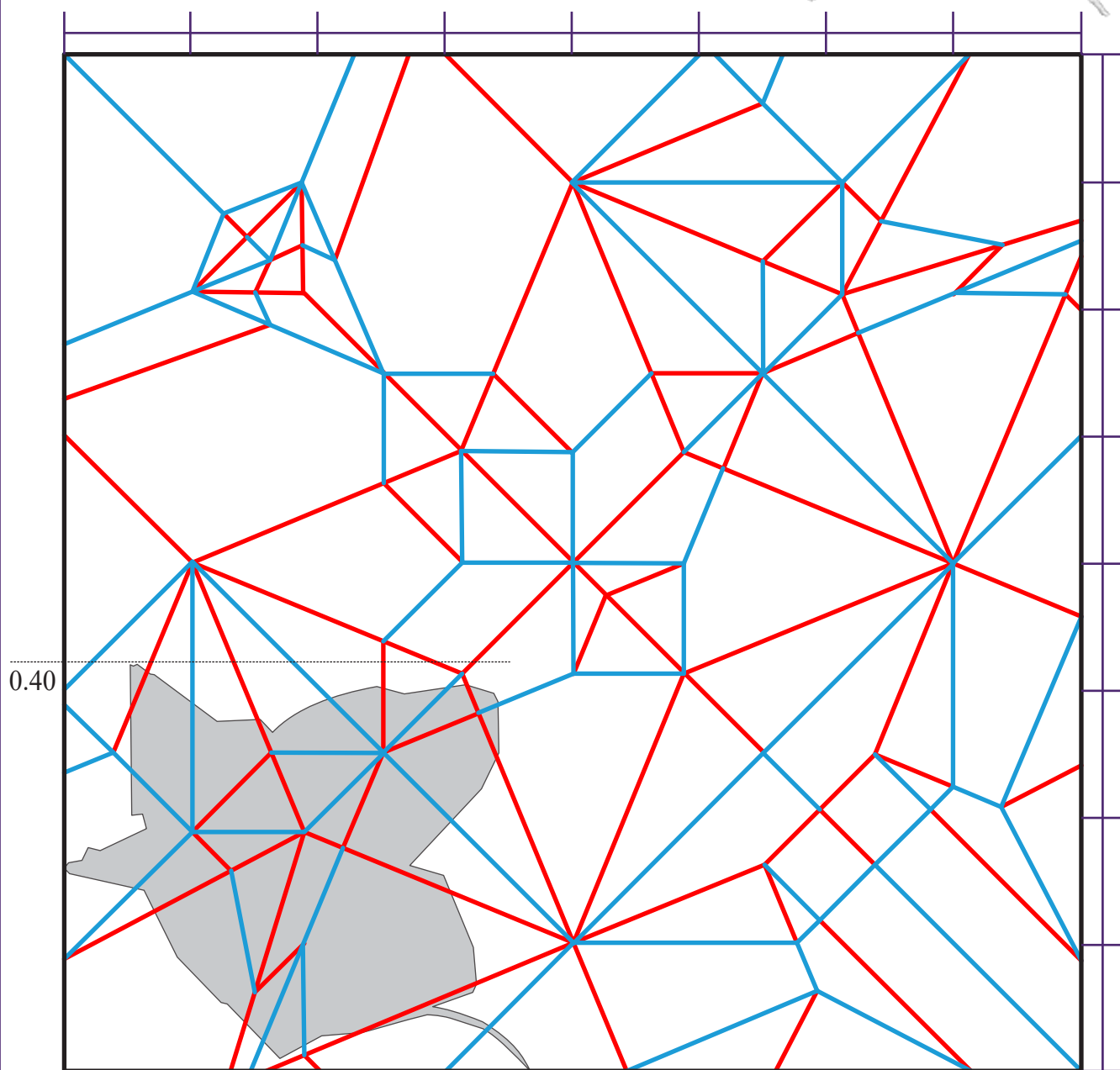

夏  
至



# 夏至

设计/Designer: 王兆健(Tony)

推荐用纸/Paper :  
- 教育折纸 30\*30 cm  
- 昆虫纸 30\*30 cm



## 32等分

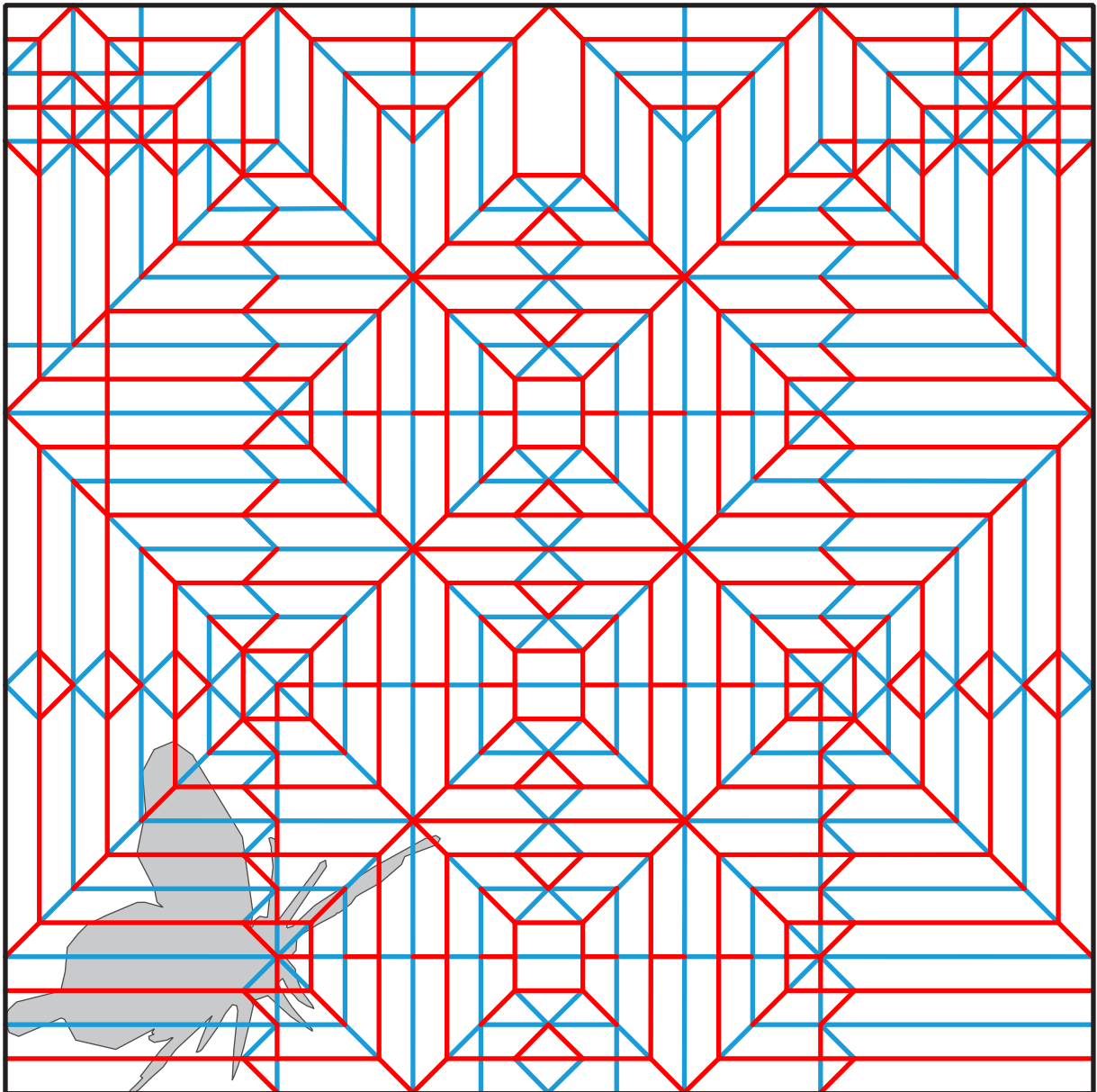

# 整形参考

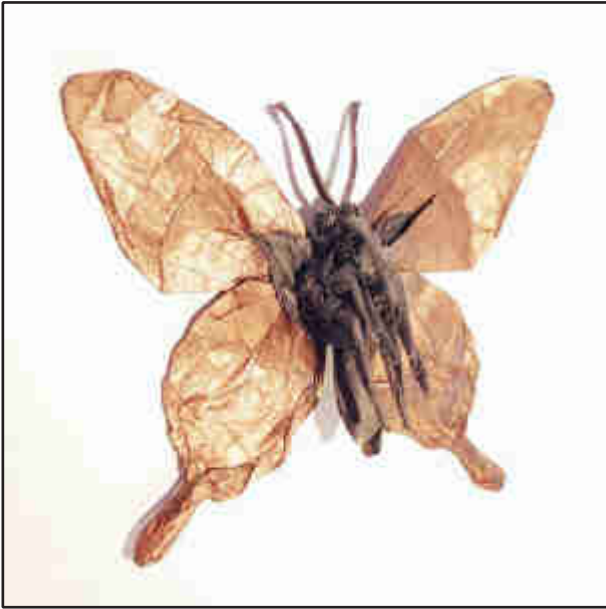



凤

蝶



# 凤蝶

设计/Designer: 子良

推荐用纸/Paper :  
- 教育折纸 24x24 cm

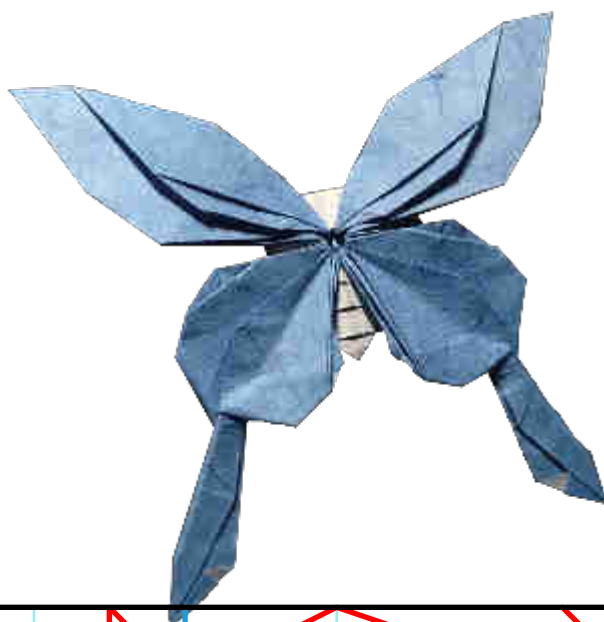

## 16等分

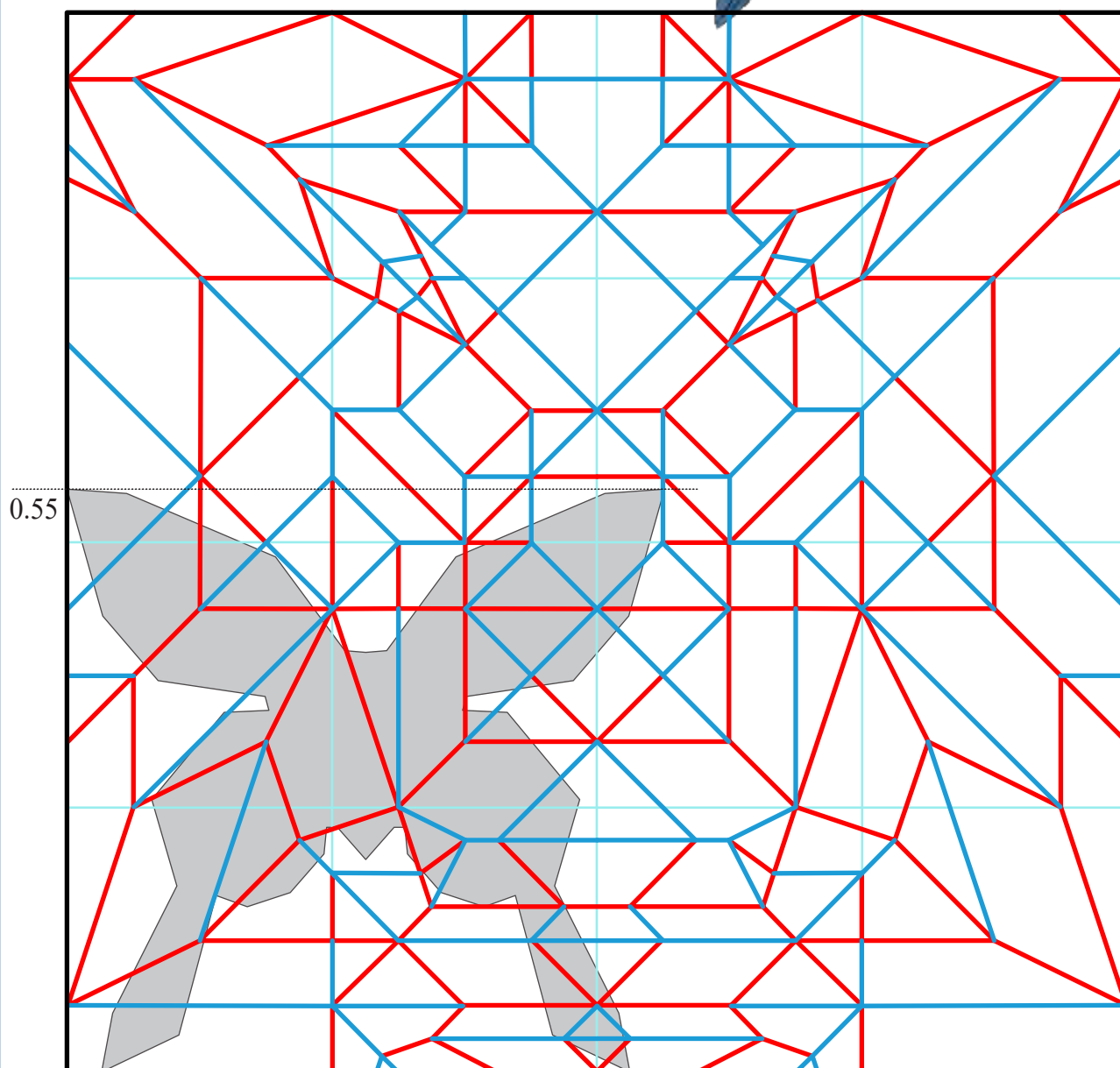



# 梅 雅



# 梅雅

设计/Designer: 陈树

推荐用纸/Paper :  
- 教育折纸 15x15 cm

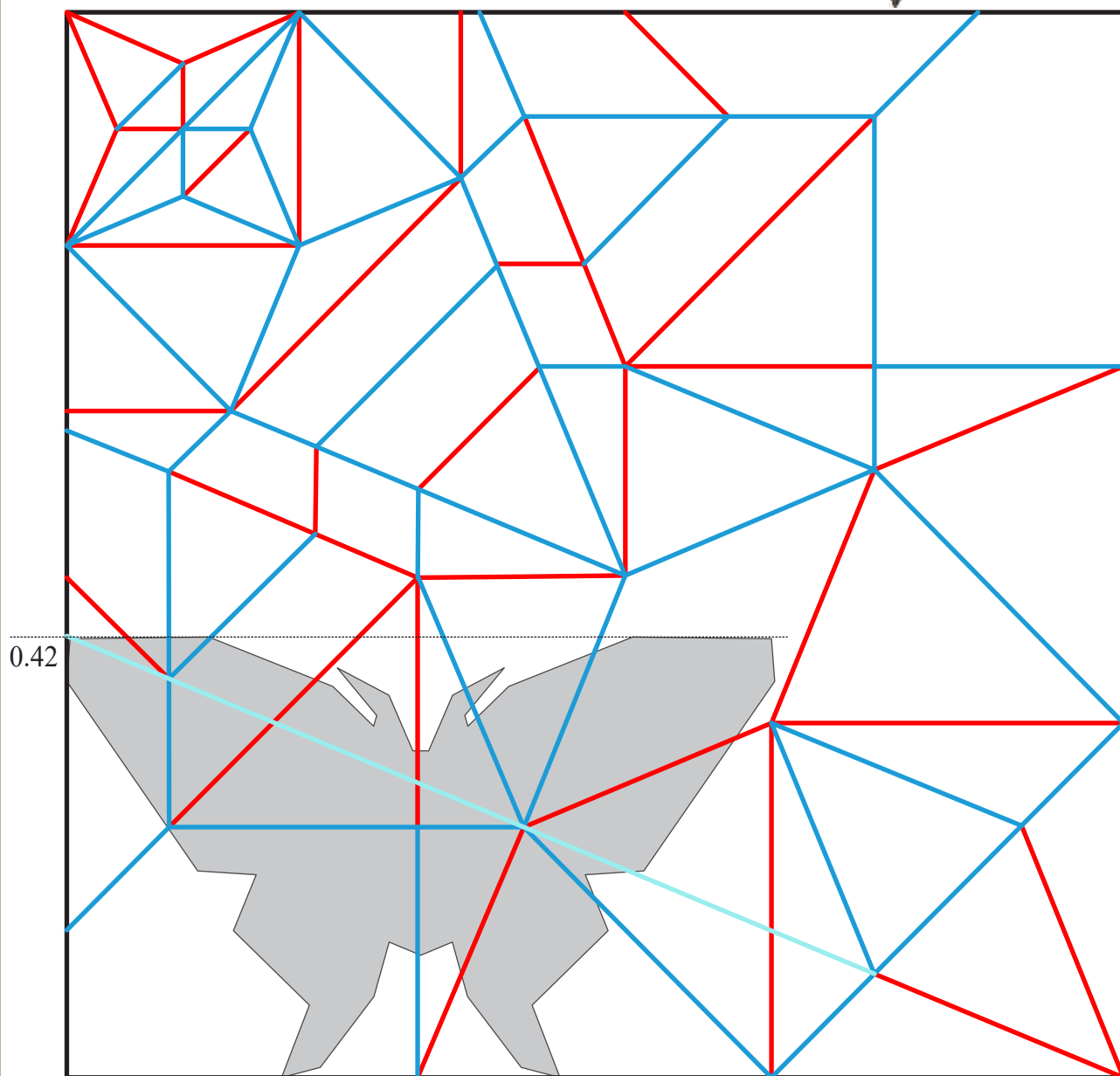

# 特别鸣谢

## 设计

陈树、陈晓 (Ob)、eR、孤雏、开明、空想、嗑盐汪、李嘉辉 (Syn)、骆昱超 (活宝小骆)、林伊桐、孟伟凝 (212Moving)、桑Q、St、Matsut4ke、王兆健 (Tony)、Tosummerny、五迷、XR、系统、徐涛 (逍遥丸子)、渔鱼余、子良、张义帆 (港欧一家)、子游君

## 内测

吉他及她、饺子、Monica、小话交通

## 教程制作

3k、郭楠 (嘲风)、小杨、银铃

1. 版权归设计者和绘图者共同所有；
2. 未经版权所有者允许不得转载翻拍本书内容，否则将视为侵权；
3. 转载或者引用本书内容请注明来源及原作者；
4. 对于不遵守此声明或者其他违法使用本书内容者，依法保留追究权。

# 国产原创折纸

二零二二年