

ハチ Bee

中級

おすすめ用紙サイズ=24×24cm

スズメバチ、アシナガバチ、ミツバチなど多くの種類があり、毒針で刺されるととても痛いものです。腹部が派手な色のものが多く、おりがみでもその模様を表現してみました。

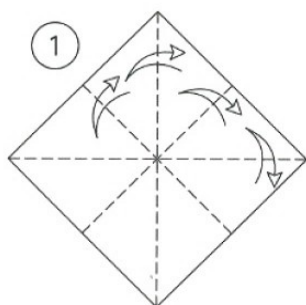
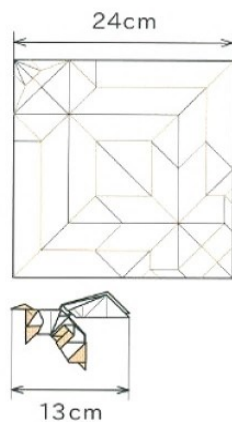

① 折りすじをつける

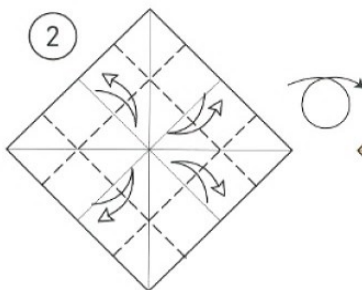

② 折りすじをつける

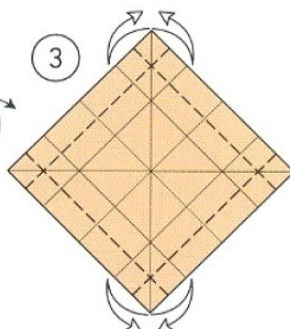

③ 折りすじをつける

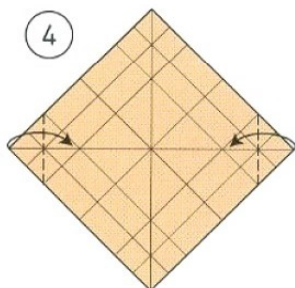

④ 三角に折る

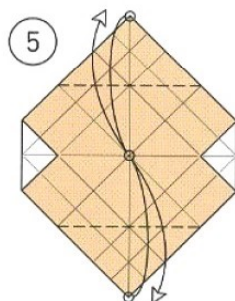

⑤ ○をあわせて
折りすじをつける

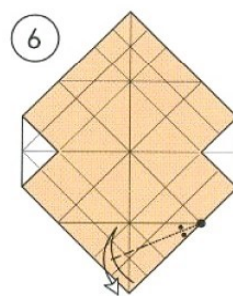

⑥ 半分の角度で
折りすじをつける

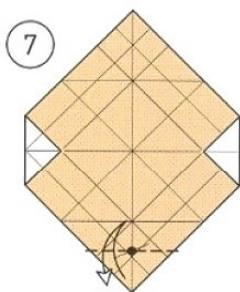

⑦ ●を基準に
折りすじをつける

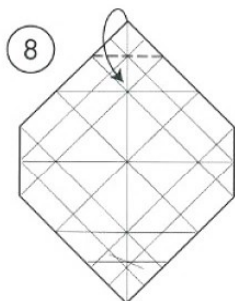

⑧ 三角に折る

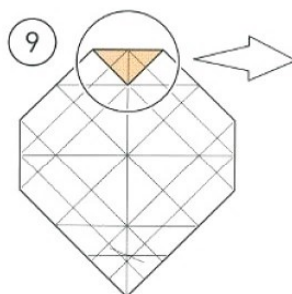

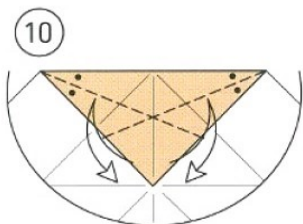

10 半分の角度で
折りすじをつける

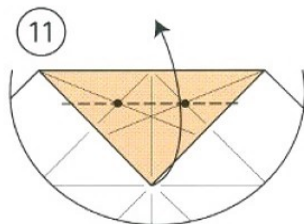

11 ●を基準に折る

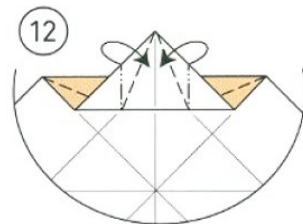

12 中心にあわせ
引きよせるように折る

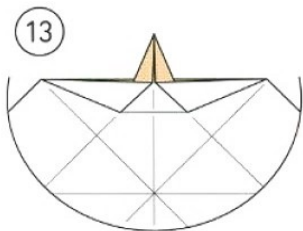

13

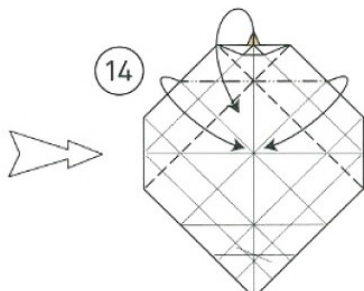

14

折りすじで折る

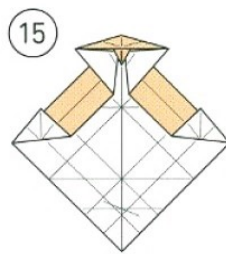

15

途中図

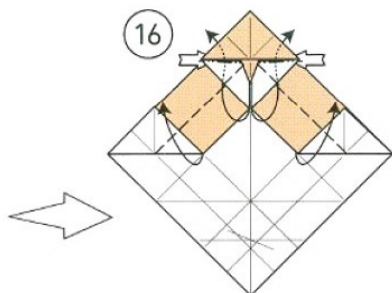

16

上部を中わり折り
しながら半分の幅で折る

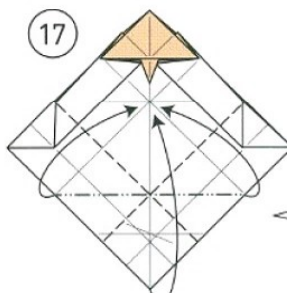

17

折りすじで折る

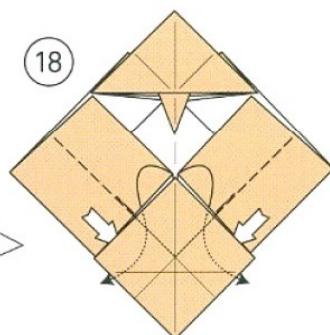

18

中わり折り

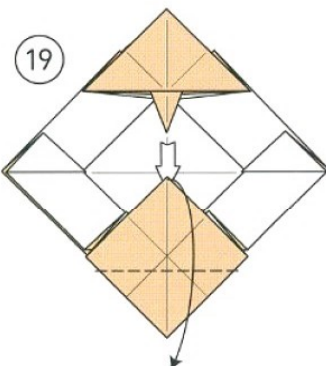

19

7でつけた折りすじで折る

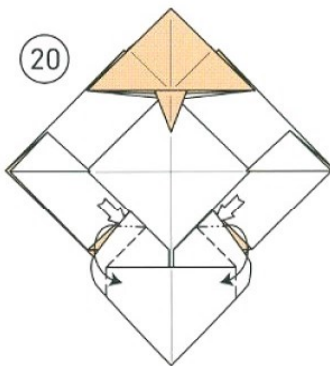

20

2か所を広げて
つぶすように折る

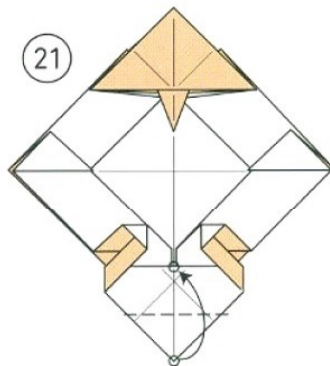

21

○をあわせて折る

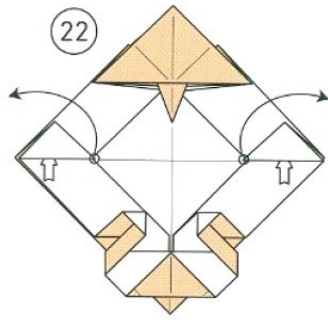

○部を引き出す

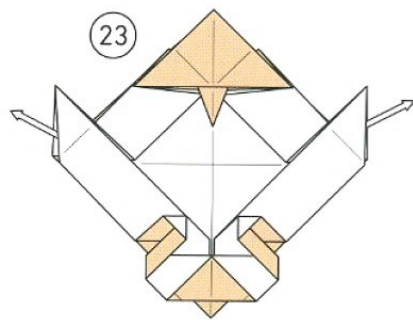

内側の重なりを外に引き出す

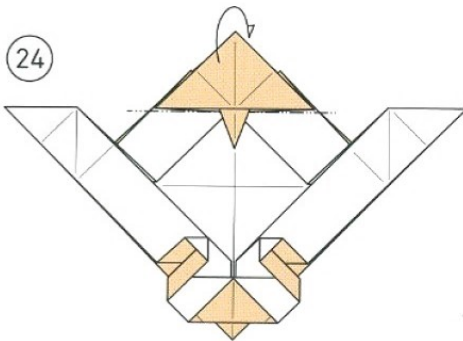

向こう側に折る

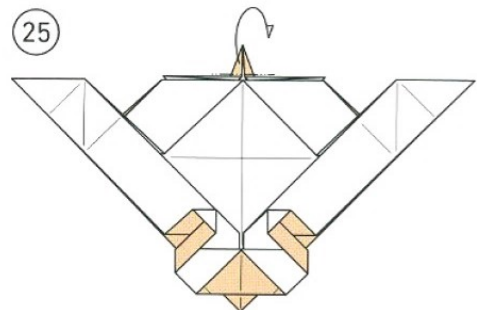

向こう側に折る

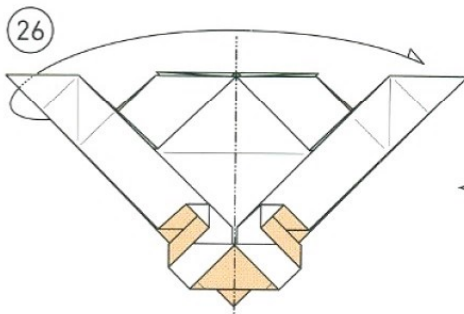

向こう側に半分に折る

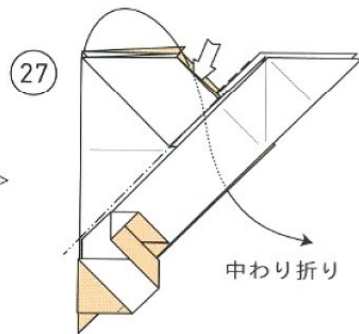
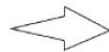

中わり折り

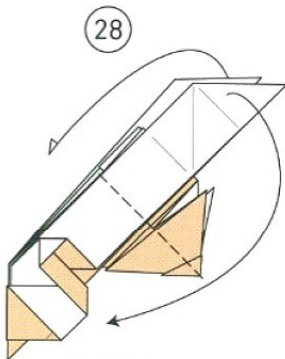

折り返す
(向こう側も同じ)

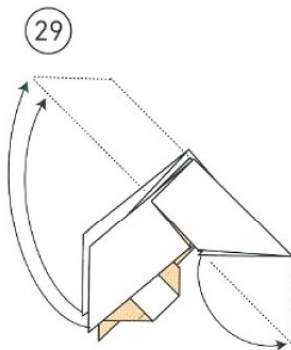

カドを引き出す
(向こう側も同じ)

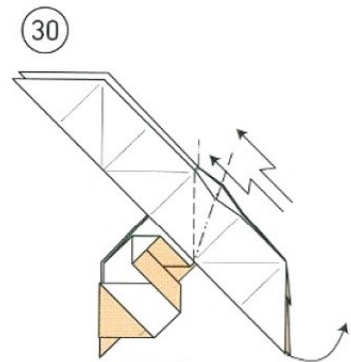

段折り

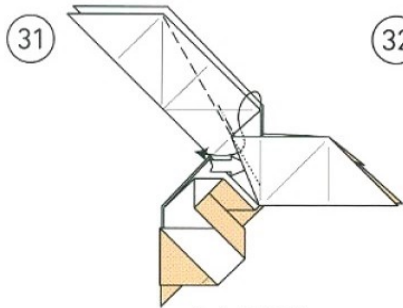

31 中わり折り
(向こう側も同じ)

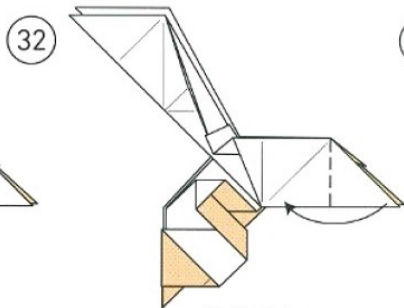

32 折り返す
(向こう側も同じ)

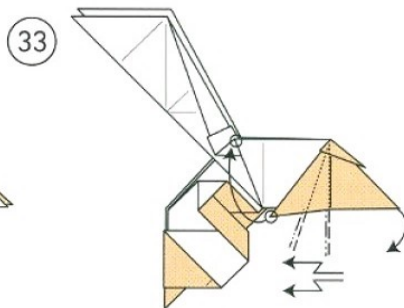

33 ○をあわせるように
段折り(向こう側も同じ)

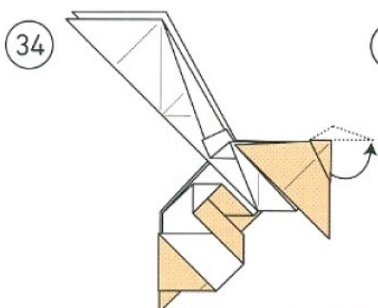

34 ずらすように折る

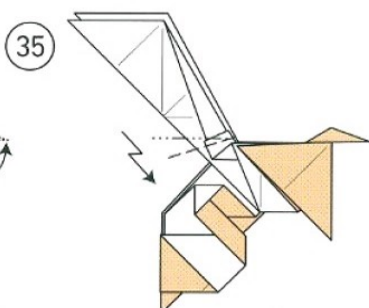

35 段折り
(向こう側も同じ)

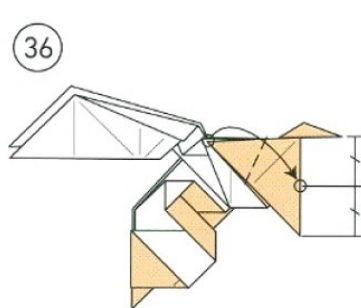

36 ○をあわせて折る
(向こう側も同じ)

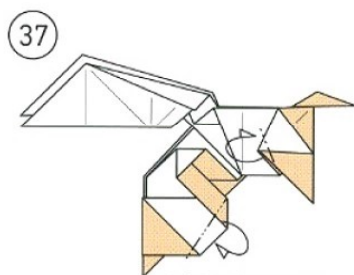

37 内側に折りこむ
(向こう側も同じ)

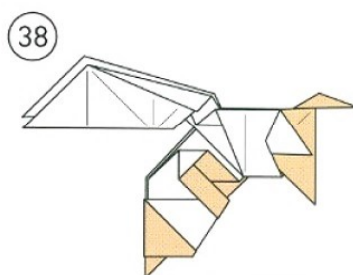

38 できあがり

