

Franco Pavarin

www.origami-cdo.it/francopavarin/

Volume 3

COMPAGNIE
MODULARE

3017, 3018, 3019, 3020, 3021, 3022, 3023, 3024, 3025, 3026, 3027, 3028, 3029, 3030, 3031, 3032, 3033, 3034, 3035, 3036, 3037, 3038, 3039, 3040, 3041, 3042, 3043, 3044, 3045, 3046, 3047, 3048, 3049, 3050, 3051, 3052, 3053, 3054, 3055, 3056, 3057, 3058, 3059, 3060, 3061, 3062, 3063, 3064, 3065, 3066, 3067, 3068, 3069, 3070, 3071, 3072, 3073, 3074, 3075, 3076, 3077, 3078, 3079, 3080, 3081, 3082, 3083, 3084, 3085, 3086, 3087, 3088, 3089, 3090, 3091, 3092, 3093, 3094, 3095, 3096, 3097, 3098, 3099, 3100

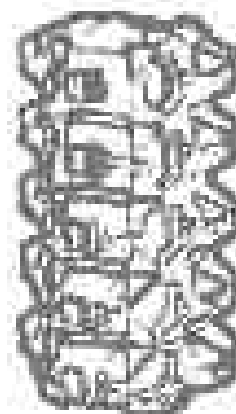
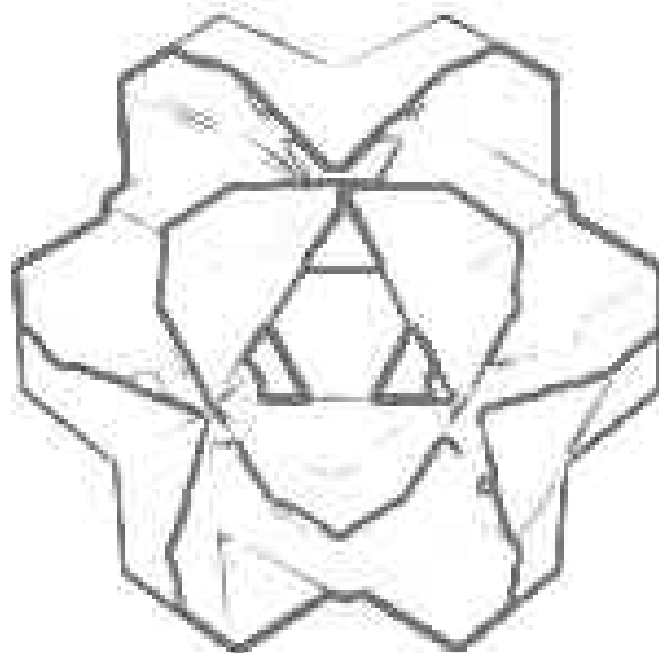
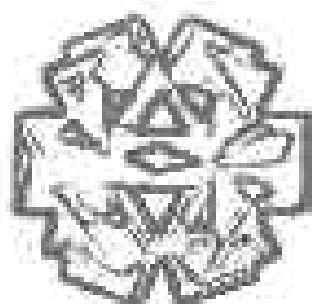

Francesco Pizzetti
www.pizzetti.com

PREFAZIONE

In questo nuovo libro ho disegnato modelli progettati da molti anni e presentati ai convegni CDO, tranne che per il "Nastro di gru", pubblicato da tempo e che rischiava di andare perso.

Le tassellazioni sono generalmente di semplice realizzazione e montaggio e che necessitano solamente di carte di colori appropriati.

I poliedri sono quasi tutti del tipo traforato, che io prediligo in quanto non occulta la tecnica costruttiva.

I moduli dei poliedri sono generalmente semplici, anche se l'unione presenta a volte qualche difficoltà.

Difficoltà che ho trovato nella rappresentazione grafica del montaggio dei moduli tridimensionali e mi scuso se in qualche caso non sono stato sufficientemente chiaro nel disegno.

Franco Pavarin gennaio 2024

In this new book I have drawn models designed for many years and presented at CDO conferences, except for the "Nastro di crane", published some time ago and which risked being lost.

Tessellations are generally simple to create and assemble and require only of cards of appropriate colors.

The polyhedra are almost all of the perforated type, which I prefer as it does not hide the technique constructive.

The modules of polyhedra are generally simple, although the union sometimes presents some difficulty.

Difficulties I found in the graphic representation of the assembly of three-dimensional modules and I apologize if in some cases I was not clear enough in the drawing.

En este nuevo libro he dibujado modelos diseñados durante muchos años y presentados en conferencias CDO, salvo el "Nastro di crane", publicado hace algún tiempo y que corría el riesgo de perderse.













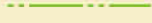









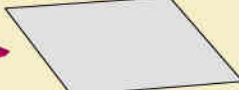

Los teselados son generalmente simples de crear y ensamblar y requieren sólo de tarjetas de colores apropiados.

Los poliedros son casi todos del tipo perforado, que prefiero porque no oculta la técnica constructivo.

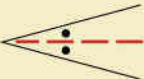
Los módulos de poliedros son generalmente simples, aunque la unión presenta en ocasiones algunas dificultad.

Dificultades que encontré en la representación gráfica del montaje de módulos tridimensionales. y pido disculpas si en algunos casos no fui lo suficientemente claro en el dibujo.

Simbologia origami

| | | Indicazione | Risultato 3D |
|-------------------------------------------------------------------------------------|------------------------------------------------------------|--------------------------------------------------------------------------------------|---------------------------------------------------------------------------------------|
|  | Piega a valle (piega bassa) |  |  |
|  | Piega a monte (piega alta) |  |  |
|  | Ruotate e piegate |  |  |
|  | Ruotate, piegate e riportate alla posizione iniziale |  |  |
|  | Ribaltate sull'asse verticale |  |  |
|  | Ribaltate sull'asse orizzontale |  |  |
|  | Ruotate di 180° |  |  |
|  | Piega bisettrice a valle |  |  |
|  | Figura ingrandita |  |  |

Realizzazione delle pieghe rovesce

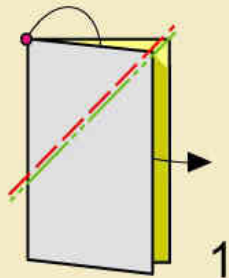

1

Eseguite una piega rovescia interna

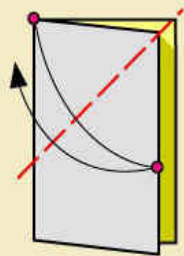

2

Una piega a valle

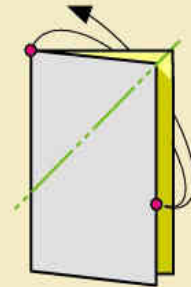

3

Ripiegate con piega a monte sulla medesima traccia

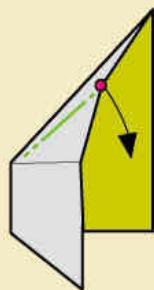

4

Aprirete e rovesciate il verso della piega

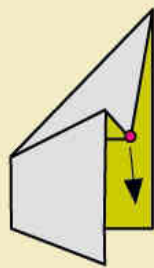

5

Inserite all'interno il vertice indicato

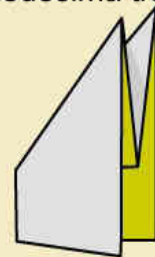

6

Piega rovescia interna ultimata

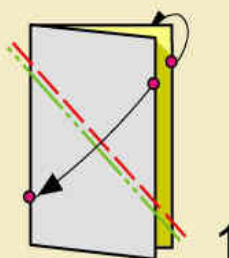

1

Eseguite una piega rovescia esterna

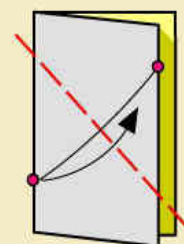

2

Una piega a valle

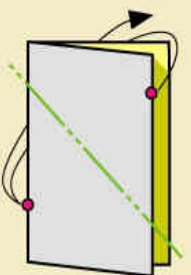

3

Ripiegate con piega a monte sulla medesima traccia

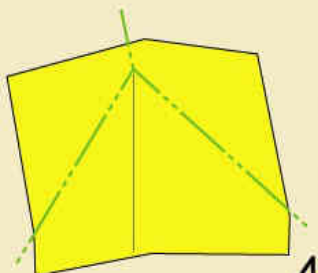

4

Aprirete e rovesciate il verso della piega

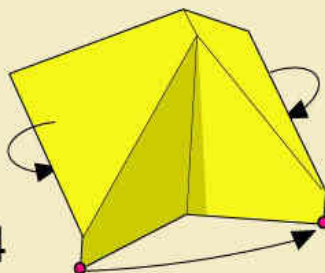











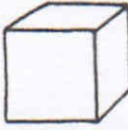













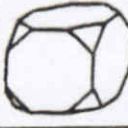







5

Richiudete



6

Piega rovescia esterna ultimata

| NOME | POLIEDRO | numero triangoli | numero quadrati | numero pentagoni | numero esagoni | numero ottagoni | numero vertici | numero spigoli |
|--------------------------|-------------------------------------------------------------------------------------|-------------------------------------------------------------------------------------------|-------------------------------------------------------------------------------------------|-------------------------------------------------------------------------------------------|-------------------------------------------------------------------------------------------|--------------------------------------------------------------------------------------------|----------------|----------------|
| TETRAEDRO |  | 4  | | | | | 4 | 6 |
| CUBO |  | | 6  | | | | 8 | 12 |
| OTTAEDRO |  | 8  | | | | | 6 | 12 |
| DODECAEDRO |  | | | 12  | | | 20 | 30 |
| ICOSAEDRO |  | 20  | | | | | 12 | 30 |
| TETRAEDRO TRONCO |  | 4  | | | 4  | | 12 | 18 |
| UBOTTAEDRO |  | 8  | 6  | | | | 12 | 24 |
| CUBO TRONCO |  | 8  | | | | 6  | 24 | 36 |
| OTTAEDRO TRONCO |  | | 6  | | 8  | | 24 | 36 |
| PICCOLO ROMBICUBOTTAEDRO |  | 8  | 18  | | | | 24 | 48 |
| GRANDE ROMBICUBOTTAEDRO |  | | 12  | | 8  | 6  | 48 | 72 |
| CUBO SIMO |  | 32  | 6  | | | | 24 | 60 |
| OSIDODECAEDRO |  | 20  | | 12  | | | 30 | 60 |

NASTRO DI GRU

Modello di Franco Pavarin. 29 05 2017

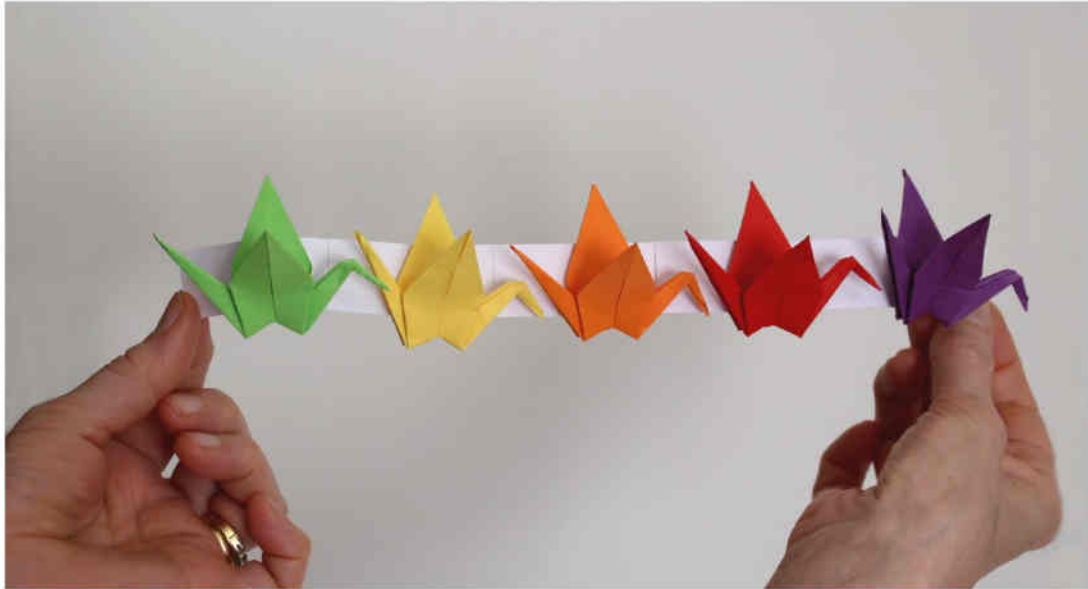

Questo nastro è formato da gru tradizionali collegate con elementi ottenuti piegando mezzi quadrati di carta robusta sempre della medesima dimensione. Per ogni gru si realizza un elemento che si incastra nell'ala retrostante.

COSTRUZIONE DELLA GRU

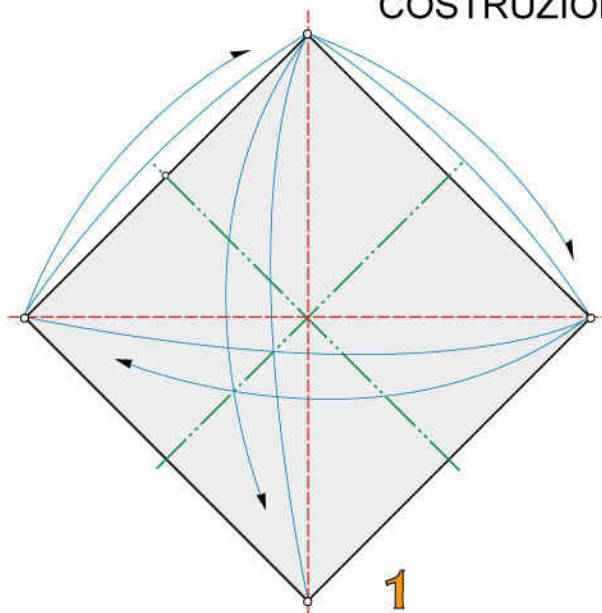

Piegate le diagonali a valle e le mediane a monte

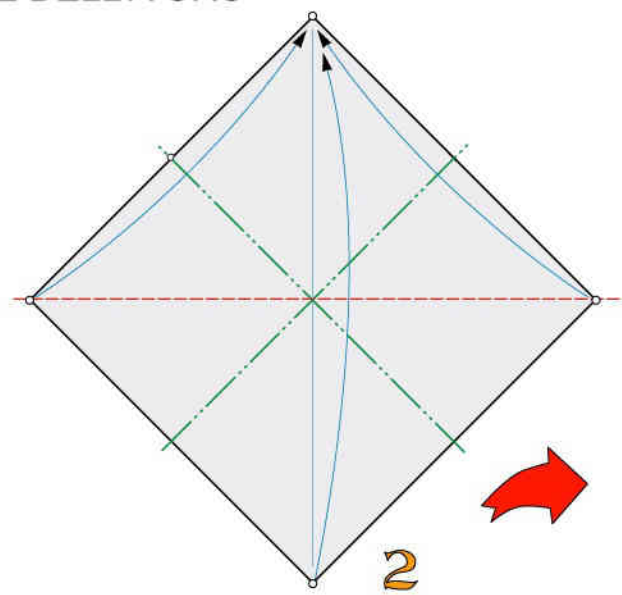

Richiudete congiungendo i vertici

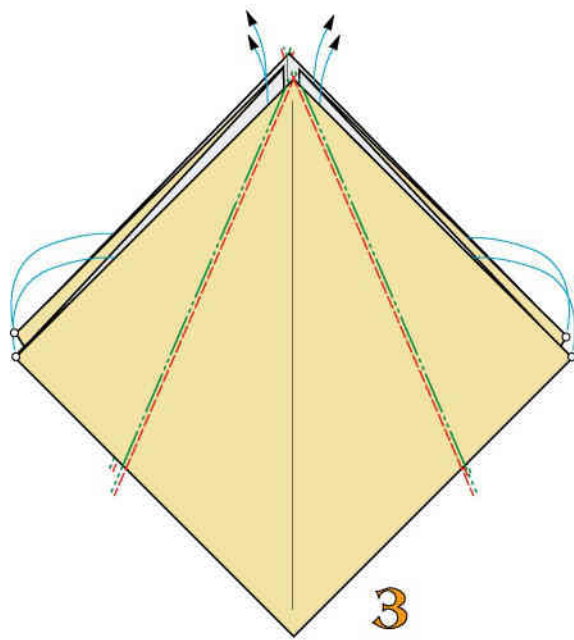

4 pieghe rovesce interne

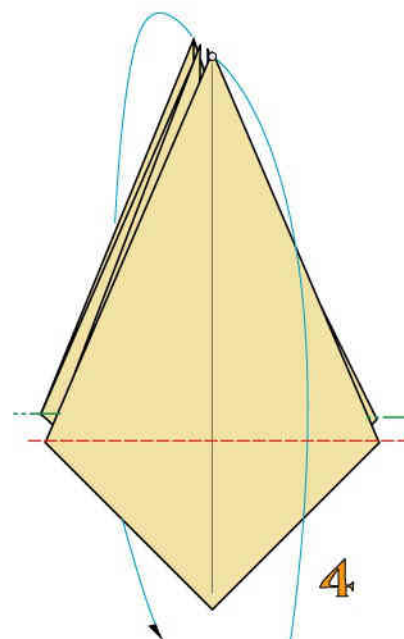

Mediante 2 pieghe a valle aprite i 2 vertici opposti

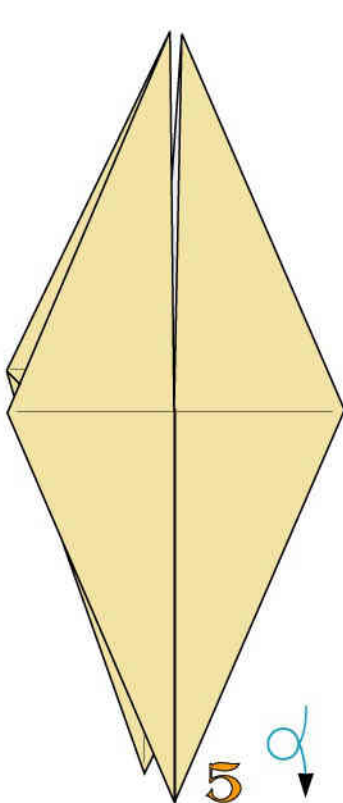

Ribaltate

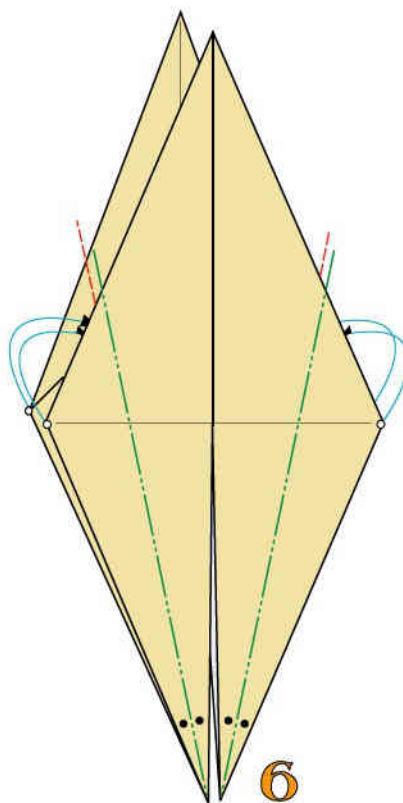

4 pieghe a monte, 2 per lato

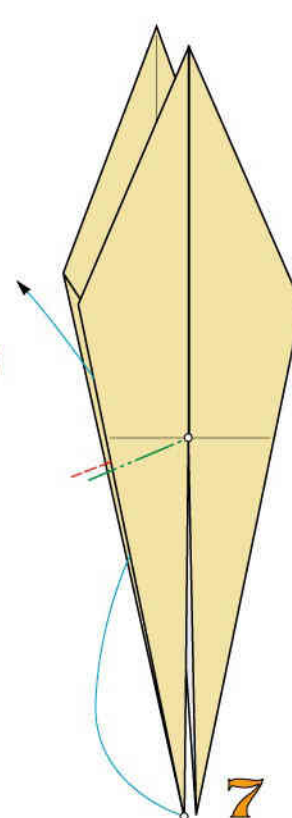

1 piega rovescia interna

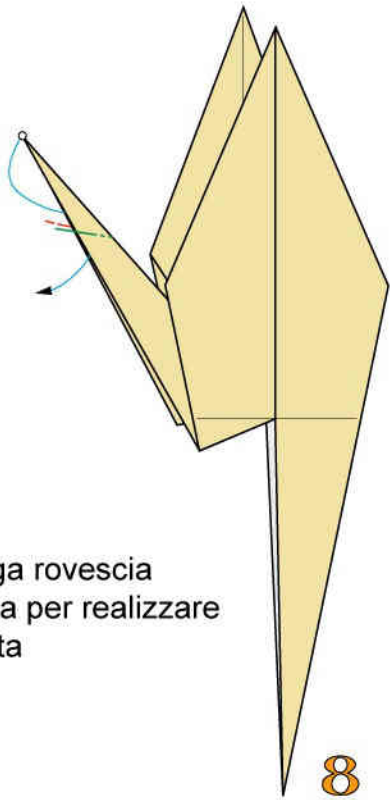

1 piega rovescia
interna per realizzare
la testa

8



Aprite l'ala per poter
spazio all'esagono
dell'elemento di
collegamento

9

UNIONE CON L'ELEMENTO DI COLLEGAMENTO

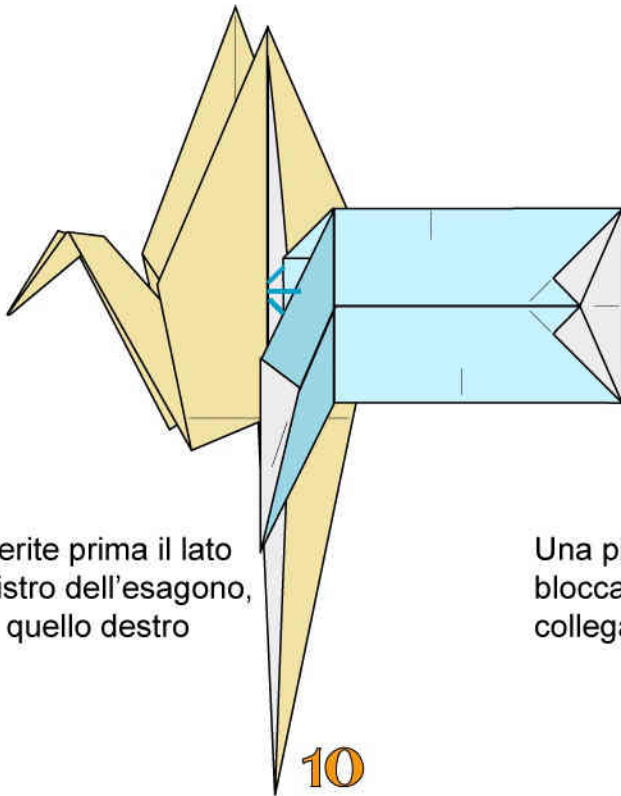

Inserite prima il lato
sinistro dell'esagono,
poi quello destro

10

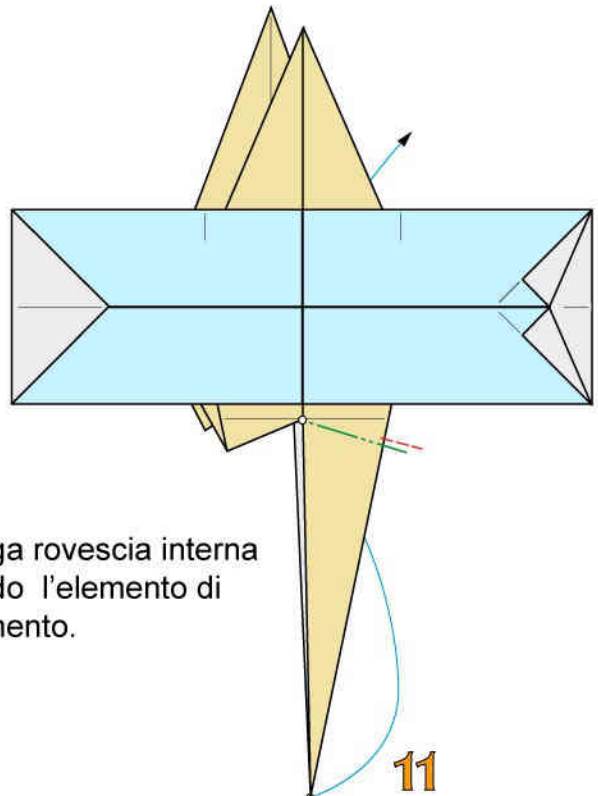

Una piega rovescia interna
bloccando l'elemento di
collegamento.

11

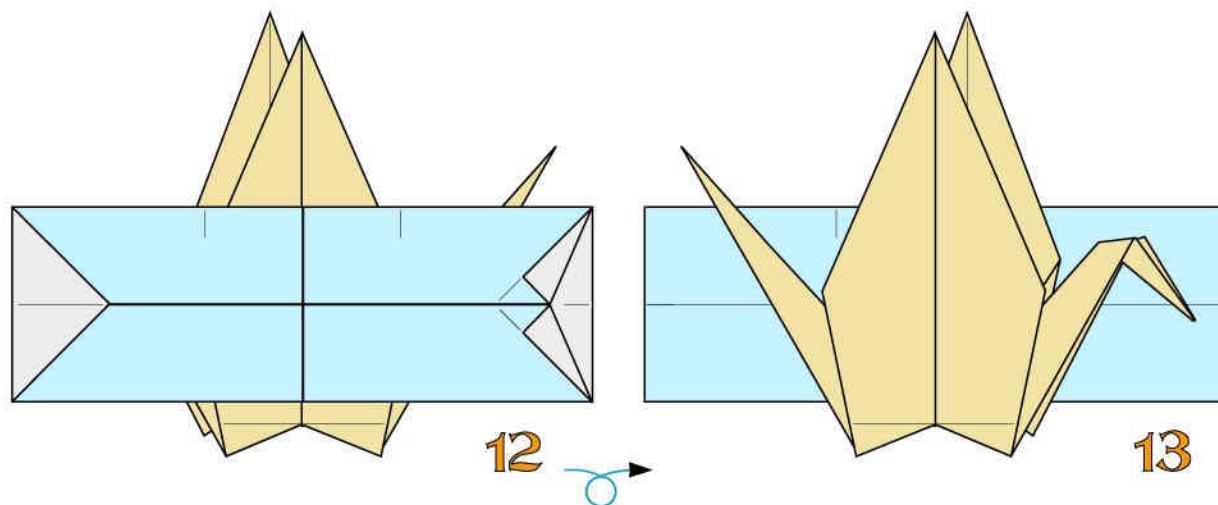

Retro di gru con elemento inserito ultimata.
Ribaltate

Fronte di gru con elemento inserito ultimata.



COSTRUZIONE DELL 'ELEMENTO DI COLLEGAMENTO

Dimezzate fogli quadrati della stessa dimensione di quelli usati per le gru.
Consiglio carta robusta di 10 cm di lato

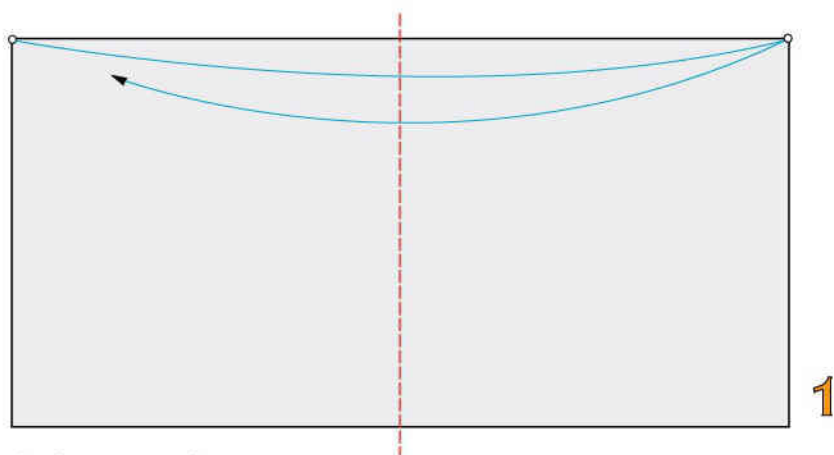

1 piega a valle



2 piccole pieghe a valle

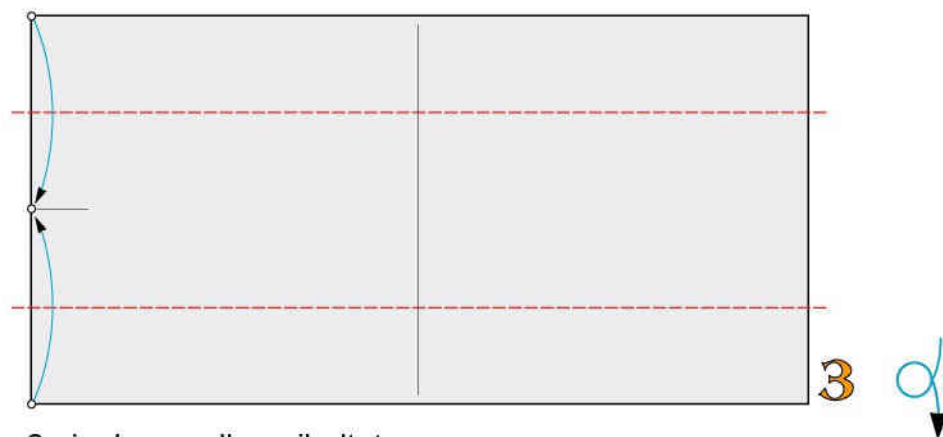

2 pieghe a valle e ribaltate

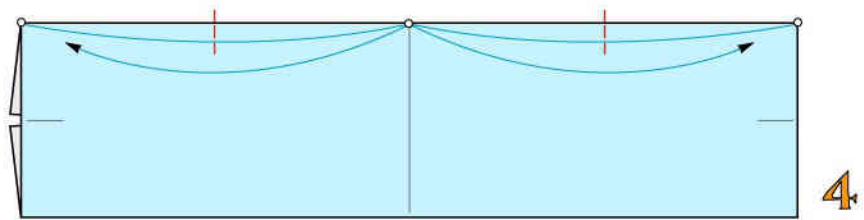

2 piccole pieghe a valle

4

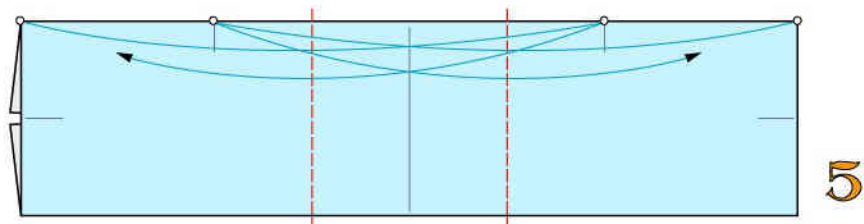

2 pieghe a valle

5

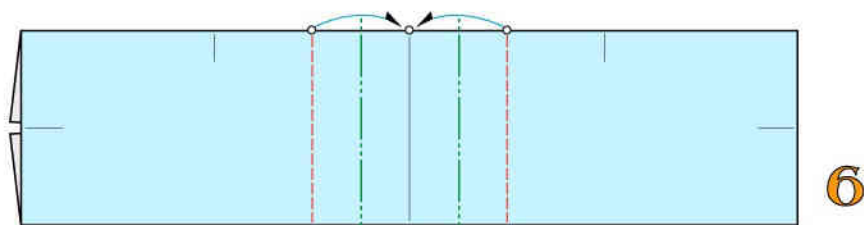

2 pieghe a monte e ripiegate a valle

6

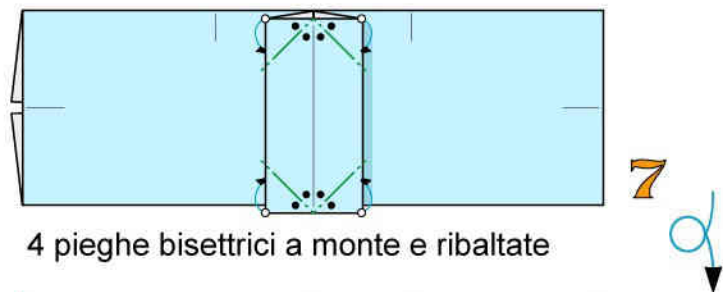

4 pieghe bisettrici a monte e ribaltate

7

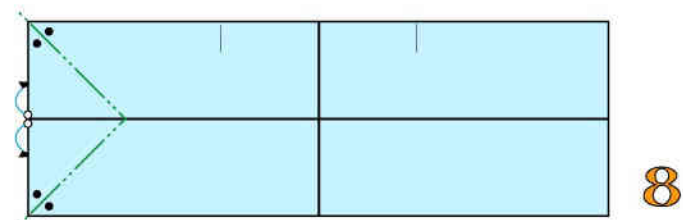

2 pieghe bisettrici a monte

8

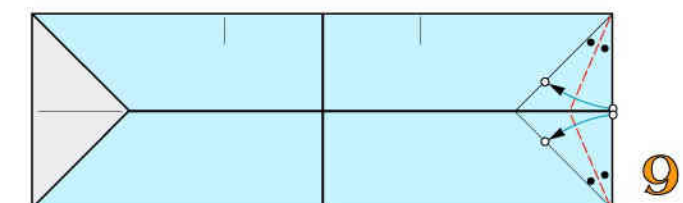

9

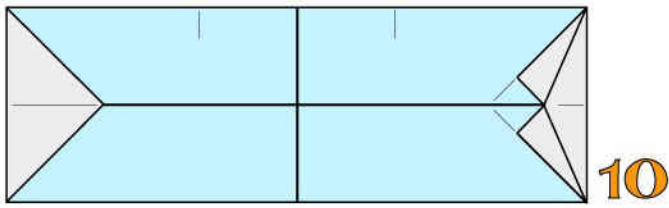

Elemento di collegamento ultimato

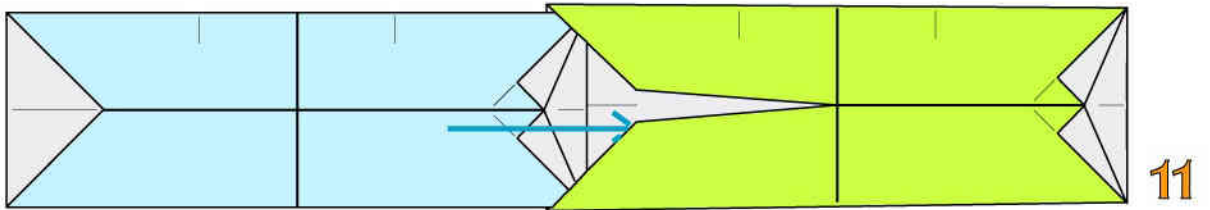

Unione di 2 elementi di collegamento: inserite quello di sinistra all'interno di quello di destra fino a che i suoi triangolini si intascano in quelli (non in vista) dell'altro

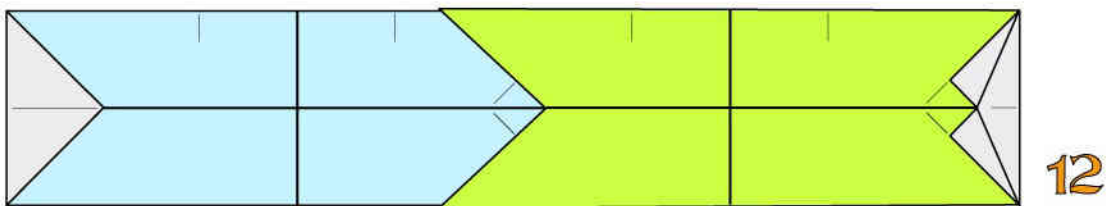

Elementi di collegamento uniti



COSTRUZIONE DELL' 'ELEMENTO DI COLLEGAMENTO CENTRALE DI UNA COLLANA

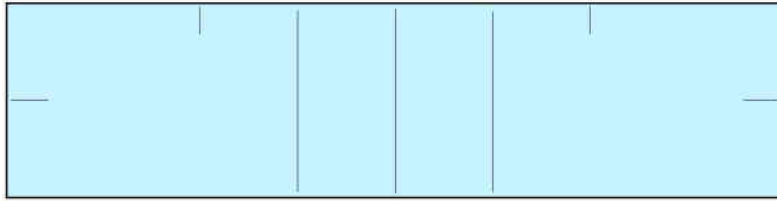

6

Partite dalla fig. n. 5 dell'elemento di coll. Ribaltate

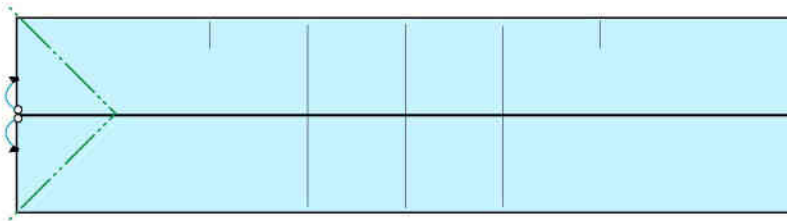

7

2 pieghe a monte

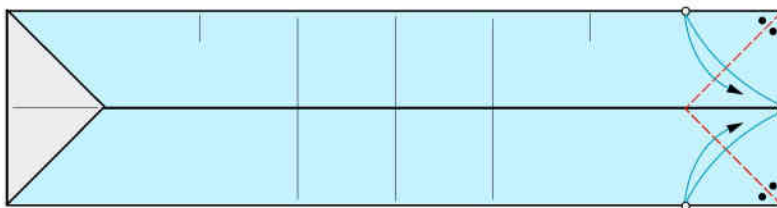

8

2 pieghe a valle

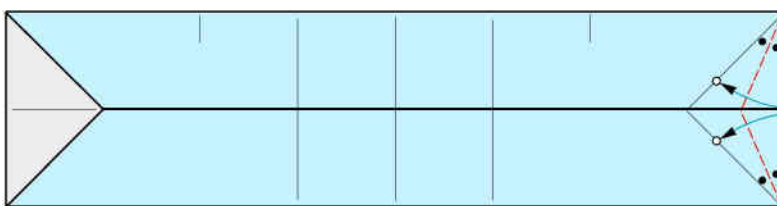

9

2 pieghe a valle

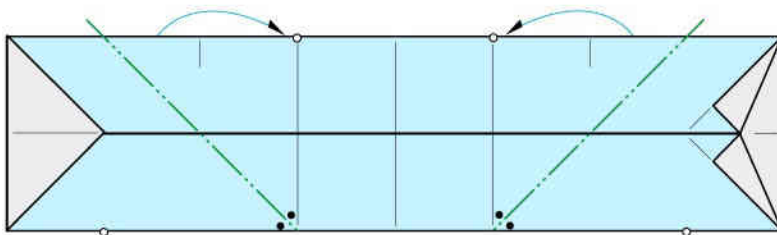

10

2 pieghe bisettrici a monte

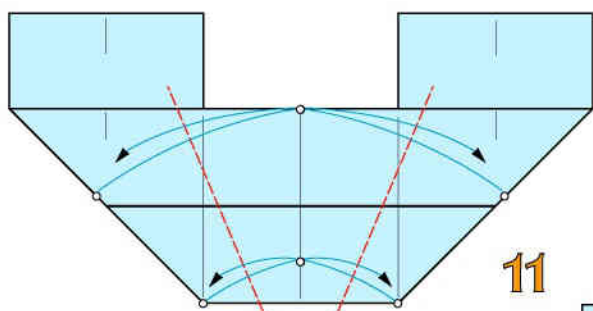

2 pieghe bisettrici a valle

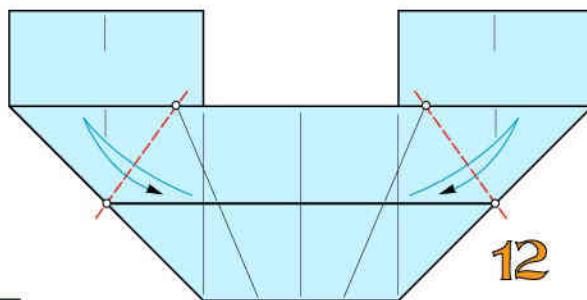

2 pieghe a valle solo sulla sup. in vista

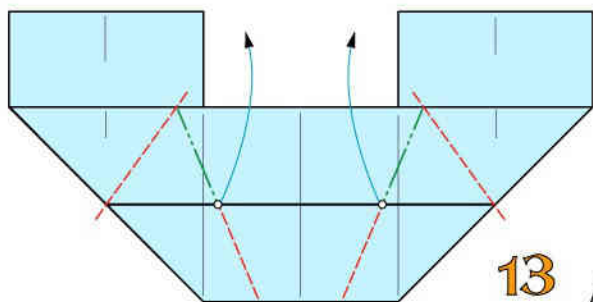

Aprite ripiegando a valle ed a monte

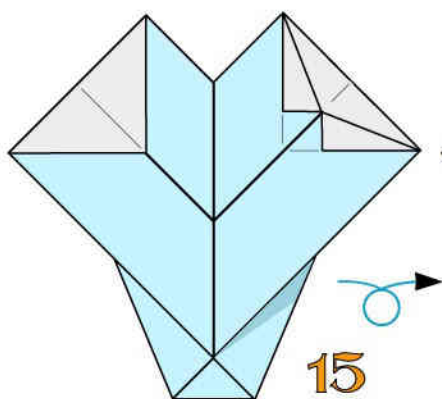
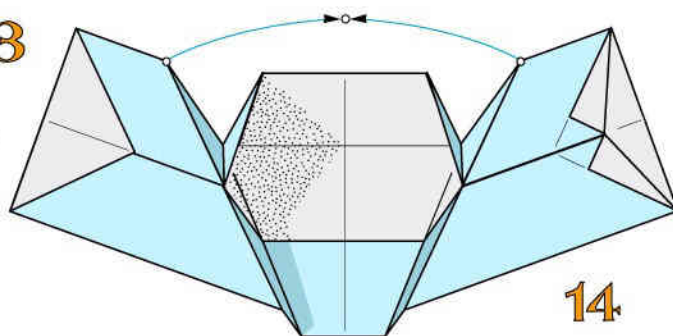

Ribaltate

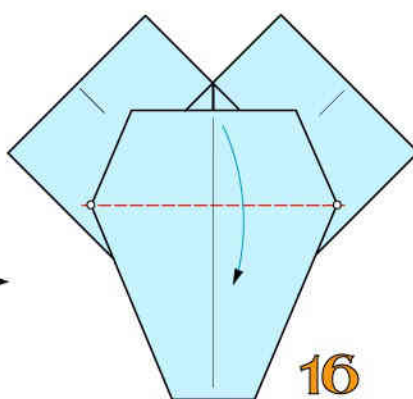

1 piega a valle

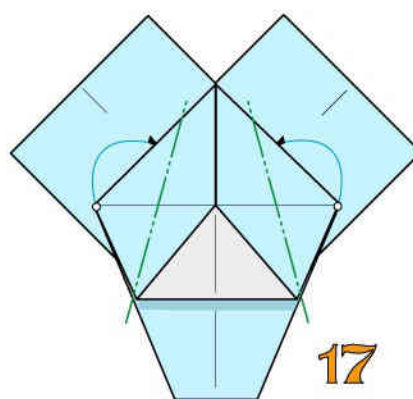

2 pieghe a monte

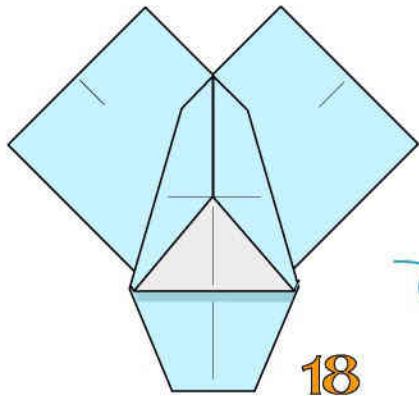

18

Ribaltate

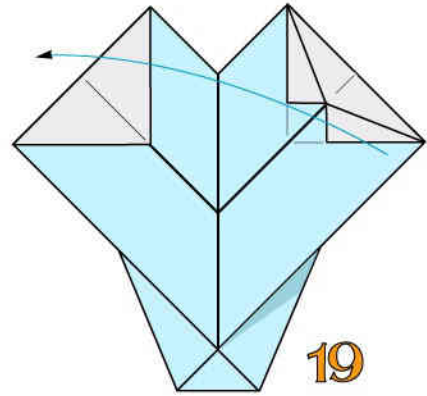

19

Ruotate la parte destra

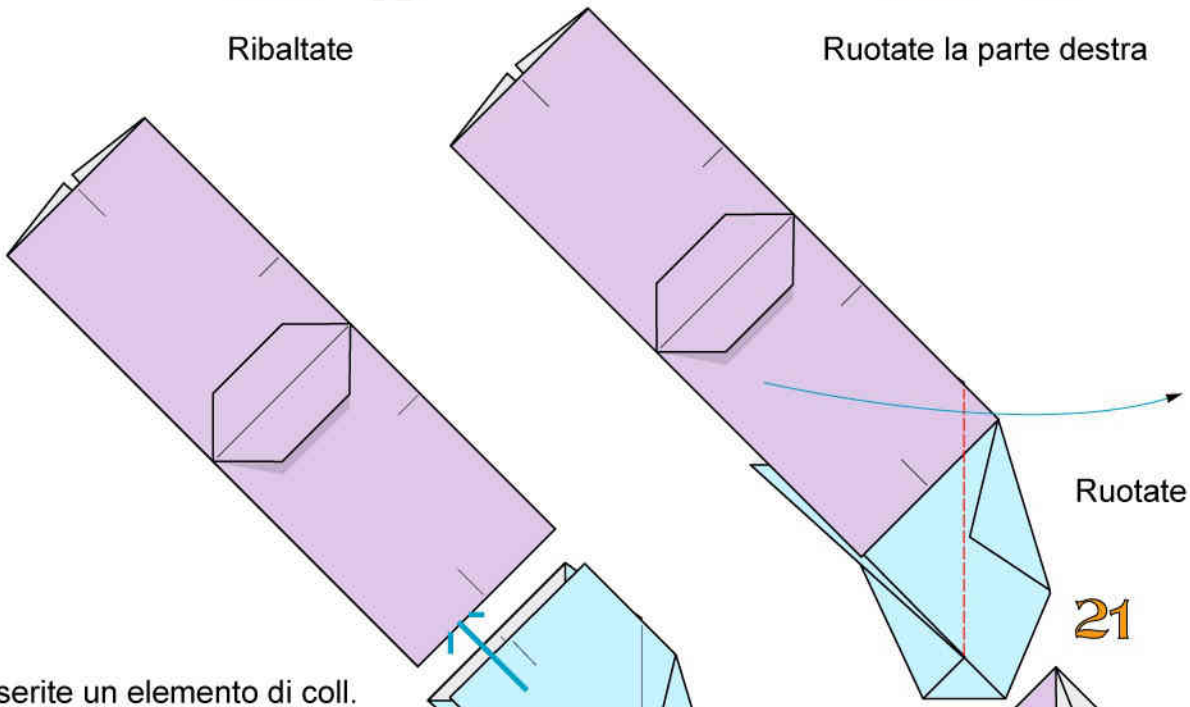

Inserite un elemento di coll.

20

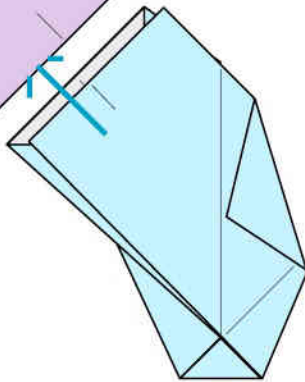

Ruotate

21

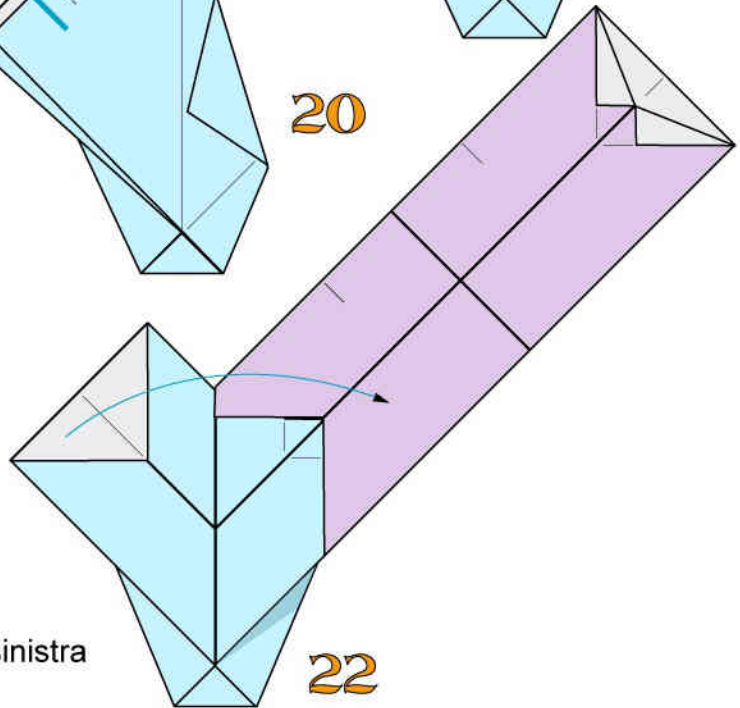

Ruotate la parte sinistra

22

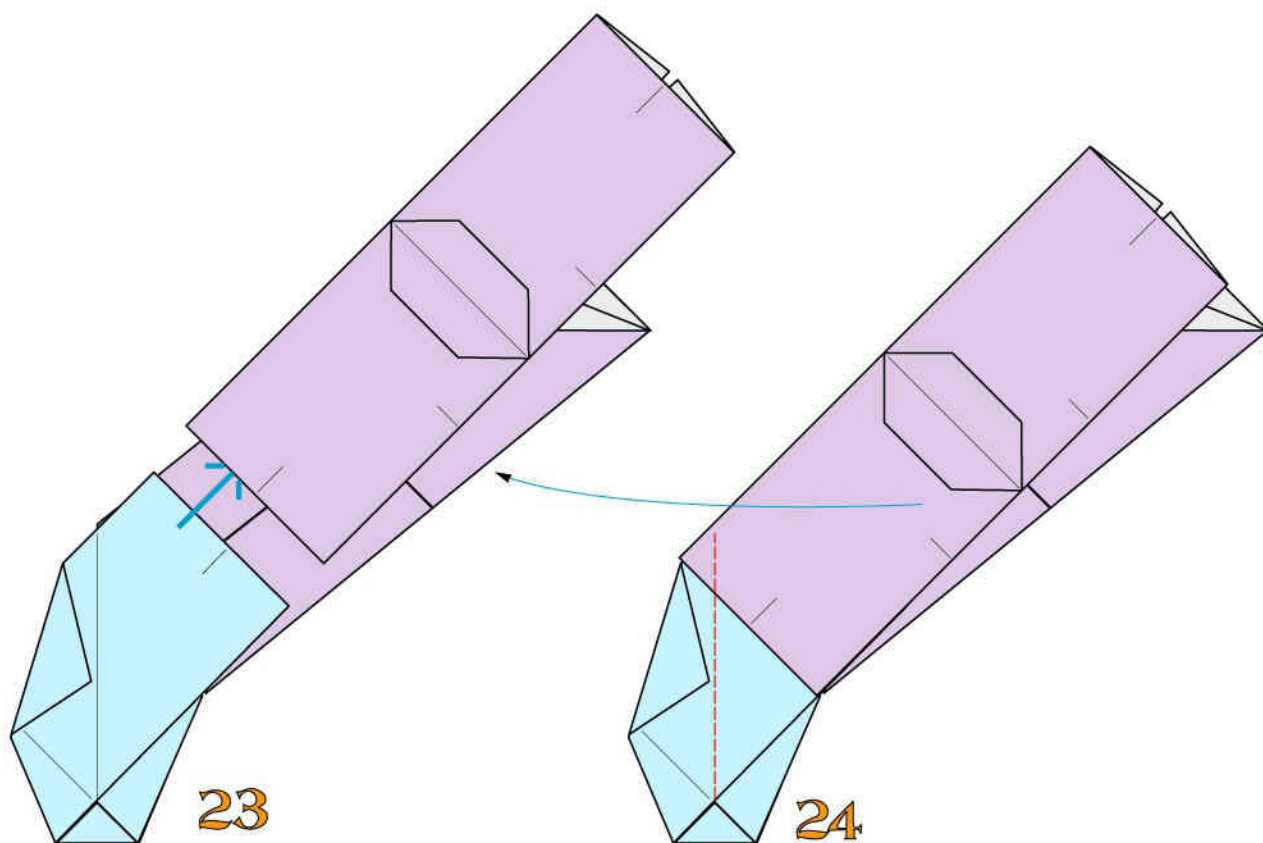

23

Inserite un ulteriore elemento di coll.

24

Ruotate

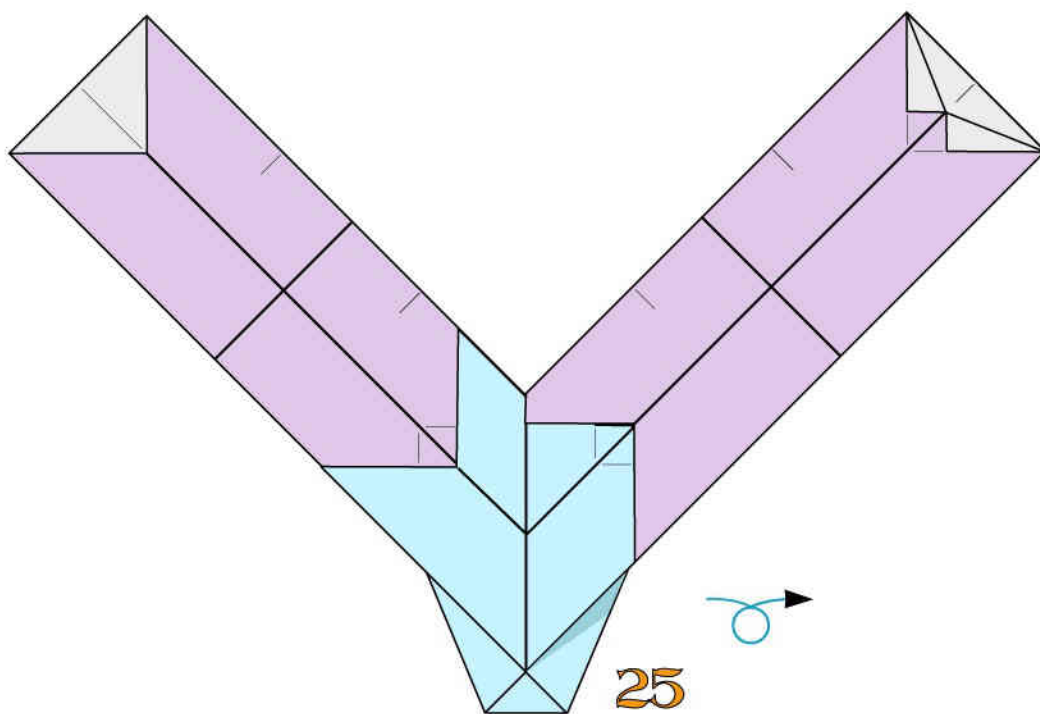

25

Elemento di collegamento centrale per collana ultimato: retro

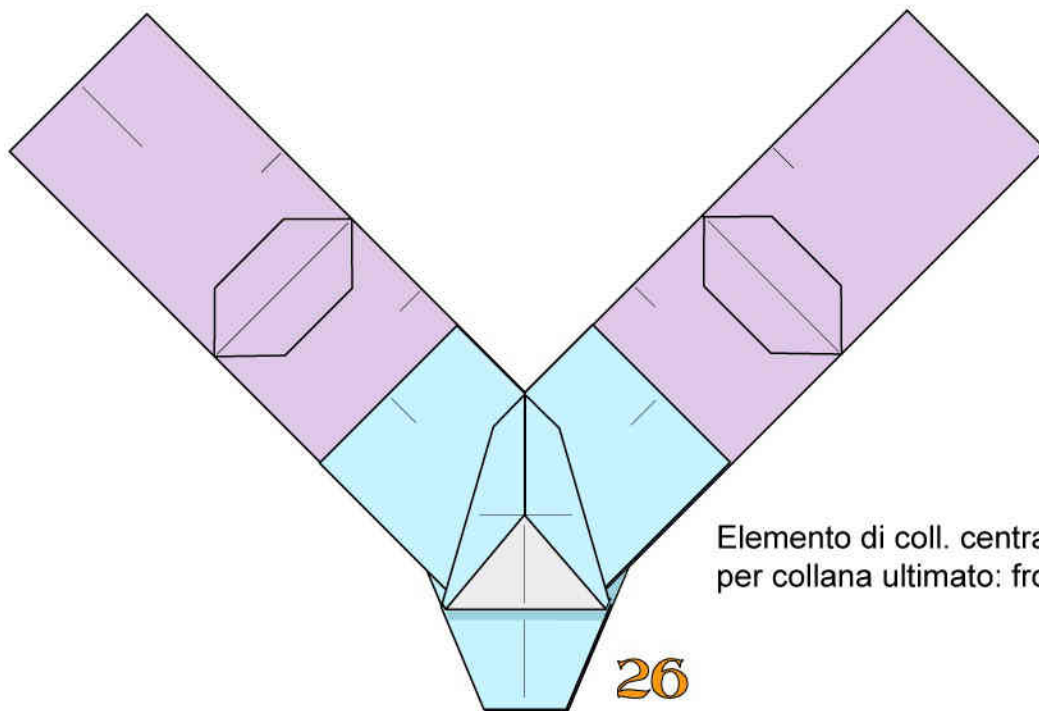

Elemento di coll. centrale per collana ultimato: fronte

26

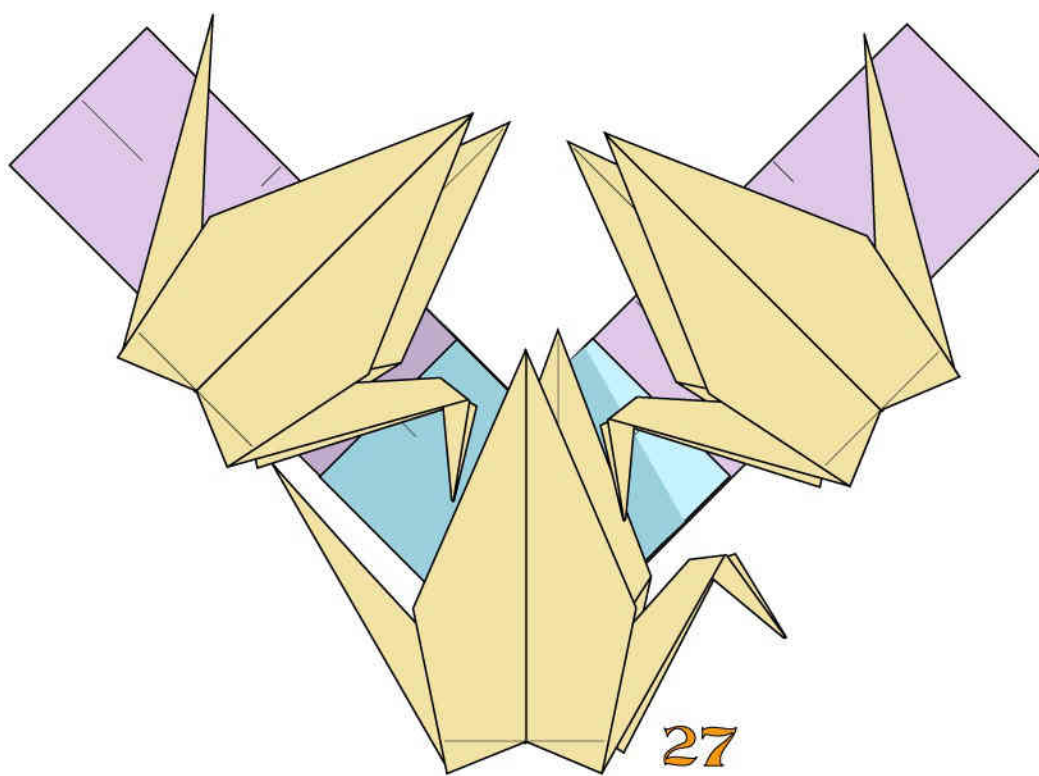

Elemento di coll. centrale per collana ultimato con gru inserite

27

Modulo di bloccaggio "1"

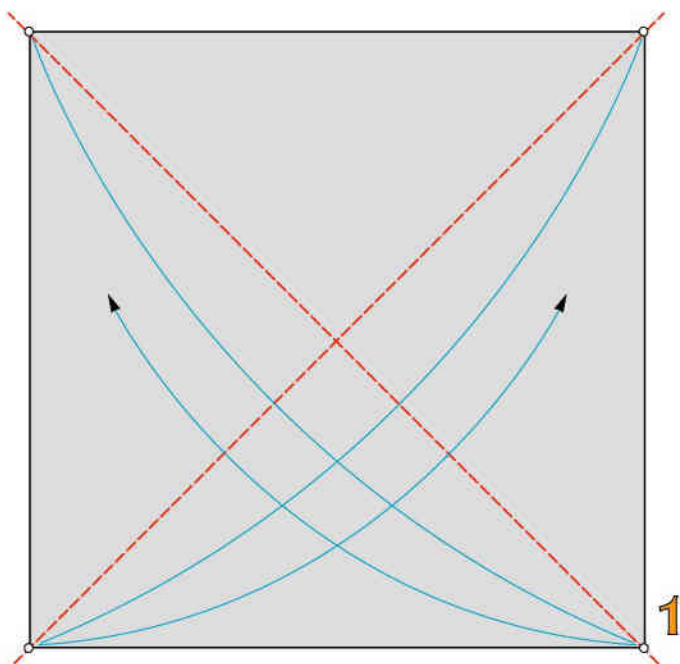

2 pieghe diagonali a valle

1

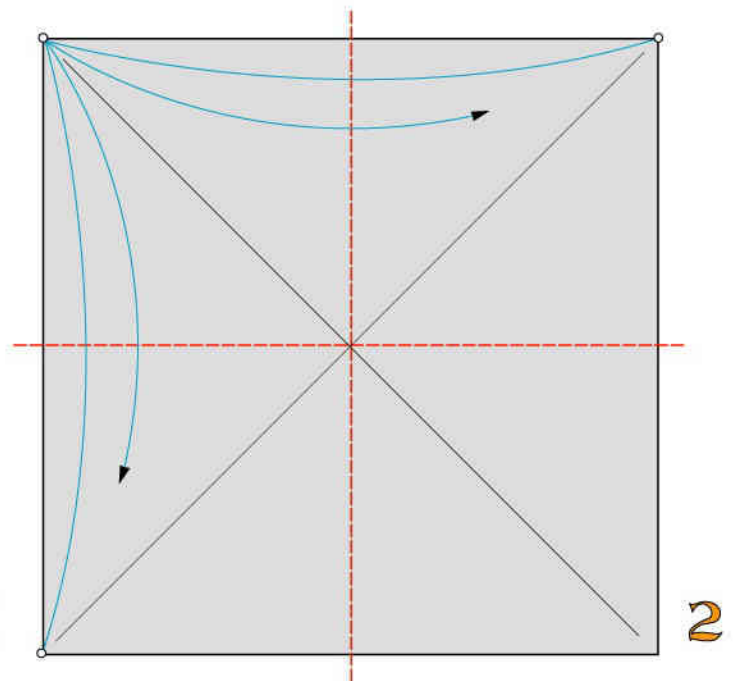

2 pieghe a valle

2

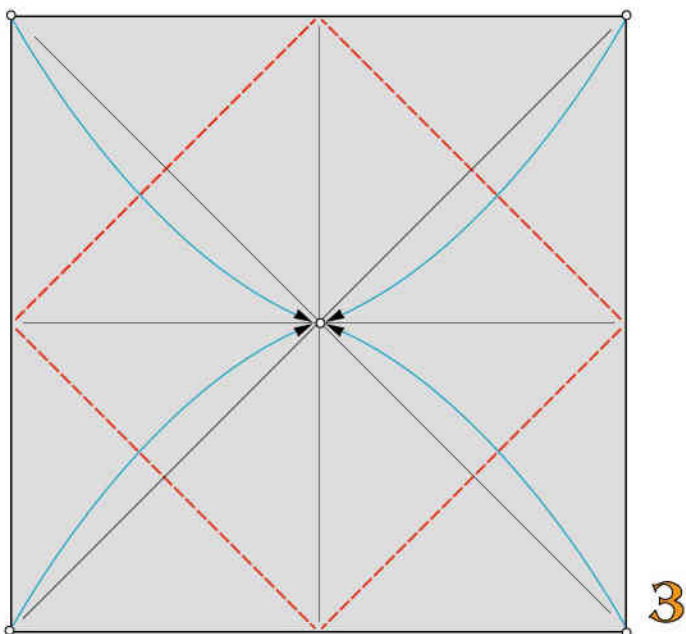

4 pieghe a valle

3

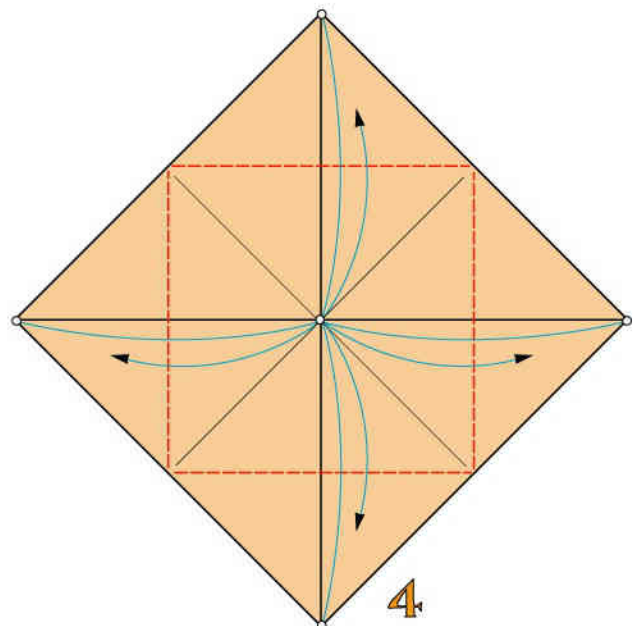

4 pieghe a valle

4

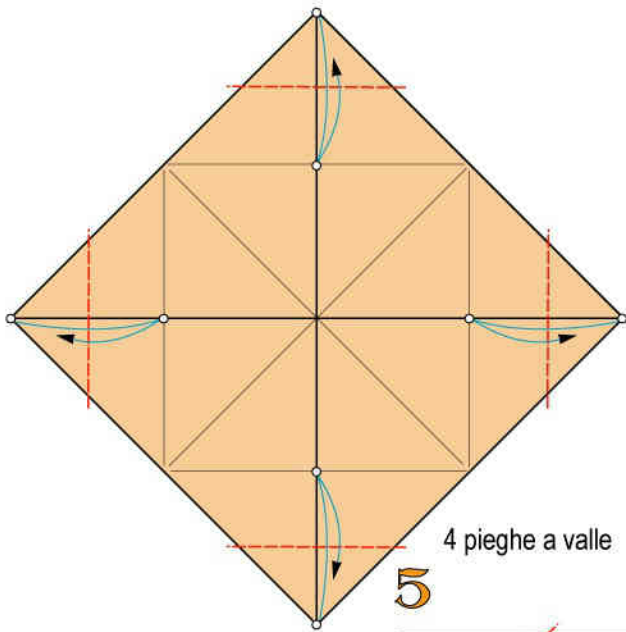

5

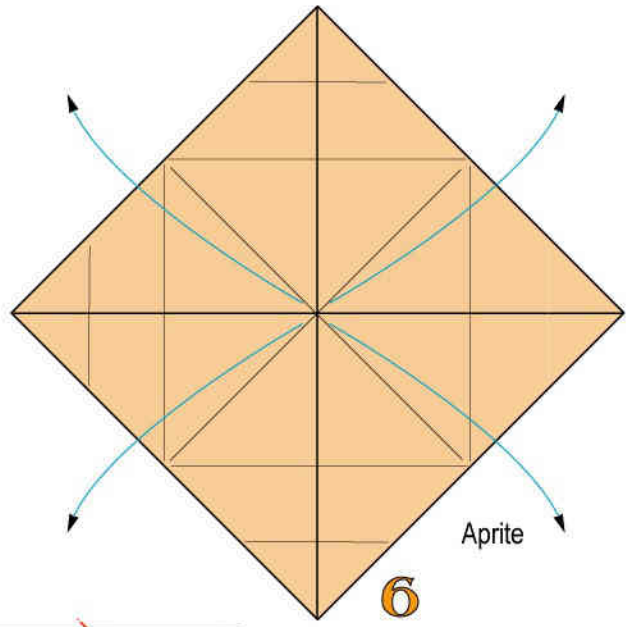

6

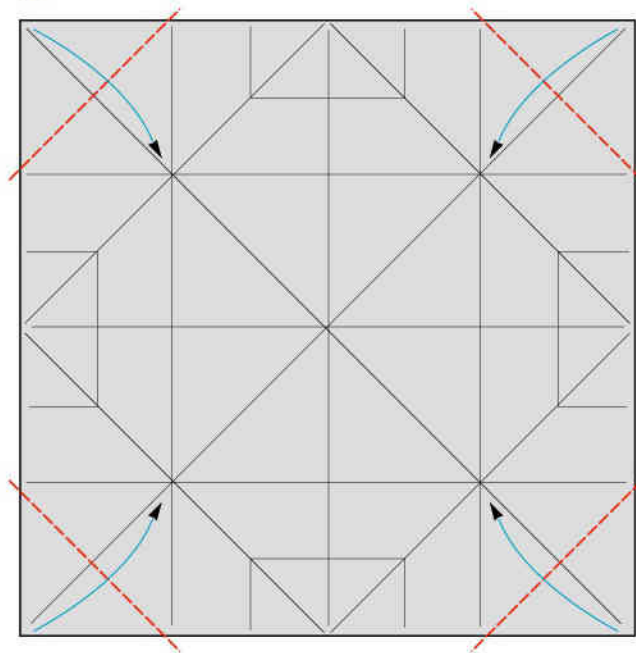

7

4 pieghe a valle

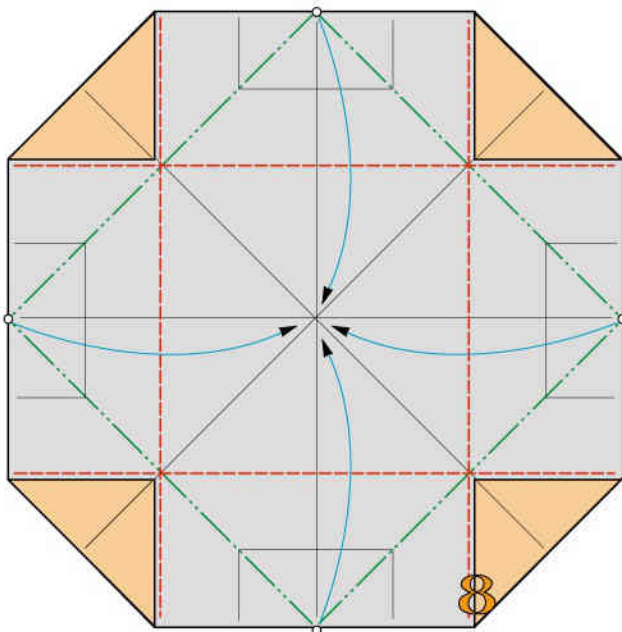

8

Ripiegate a valle e a monte

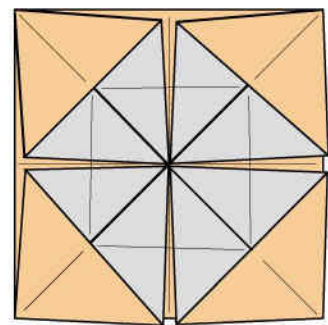

9

Modulo "1" ultimato

TASSELLAZIONE "A"

MODULARE TRAFORATA

Franco Pavarin 23

Si realizza unendo moduli "A" con moduli di bloccaggio.
Adoperate carta bicolore leggera per i moduli "A" e monocolori di medio peso per i moduli di bloccaggio.

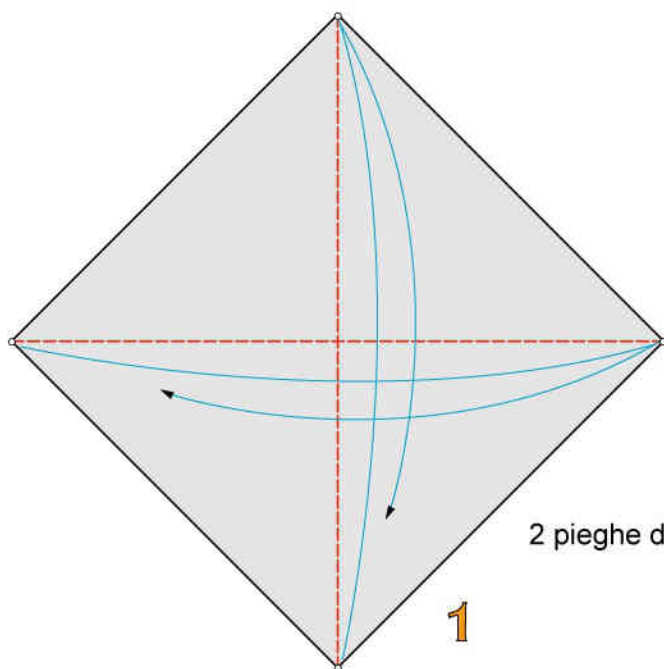
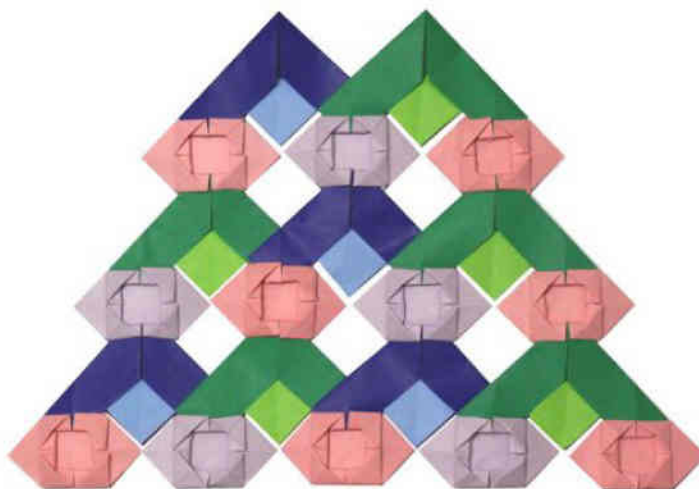

2 pieghe diagonali a valle

1

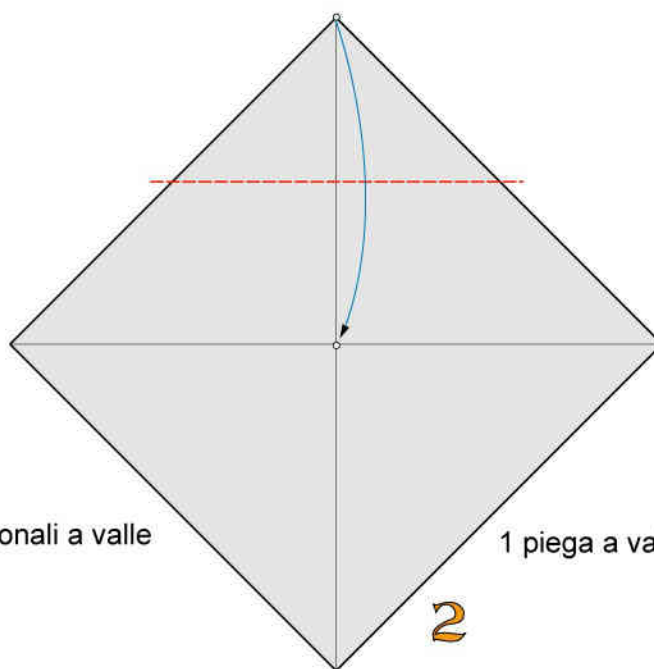

1 piega a valle

2

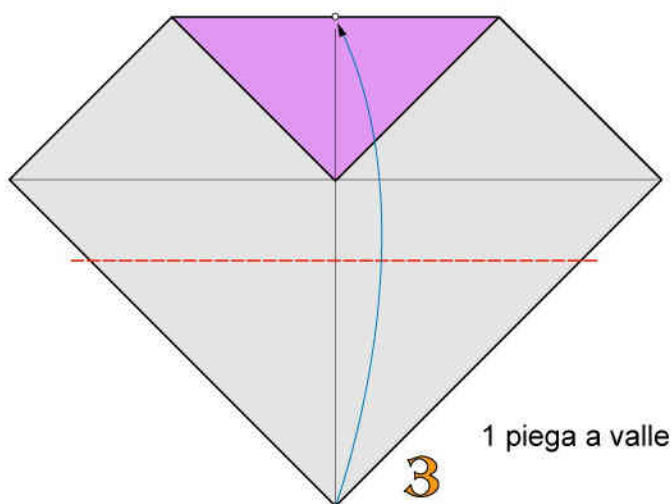

1 piega a valle

3

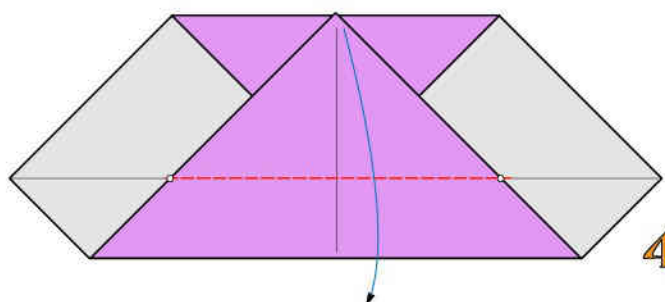

1 piega a valle

4

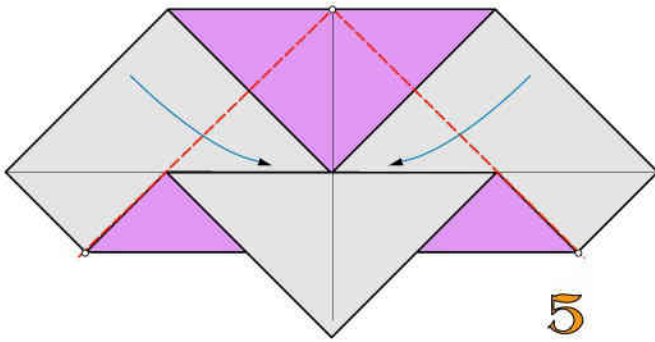

2 pieghe a valle

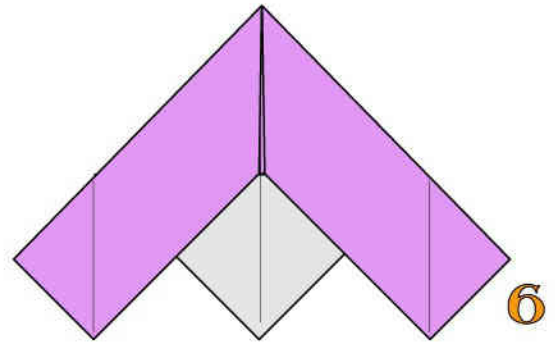

Modulo "A" ultimato

UNIONE DEI MODULI

Inserite i moduli "A" all'interno del modulo di bloccaggio

Mediante pieghe a monte bloccate l'unione

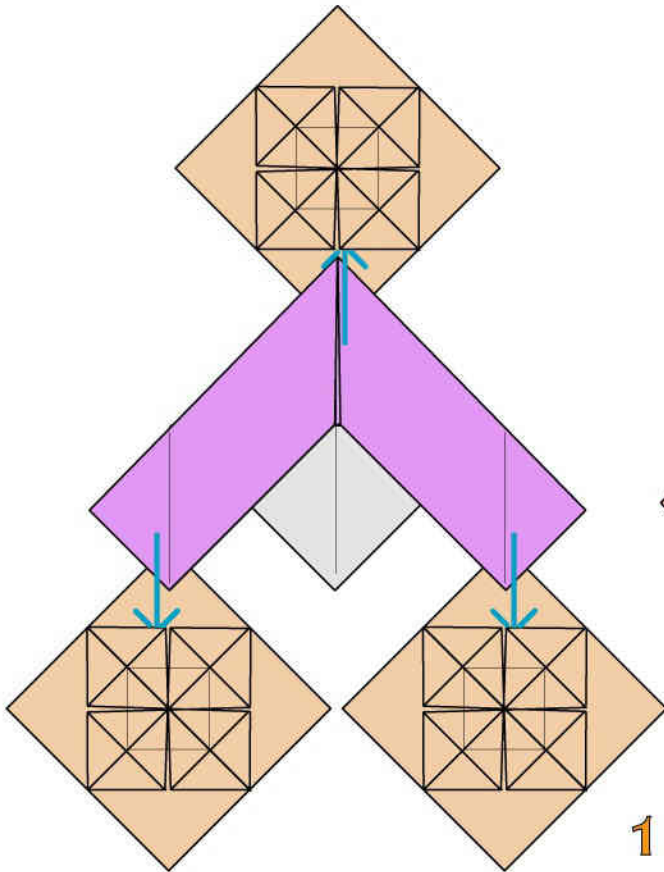

1

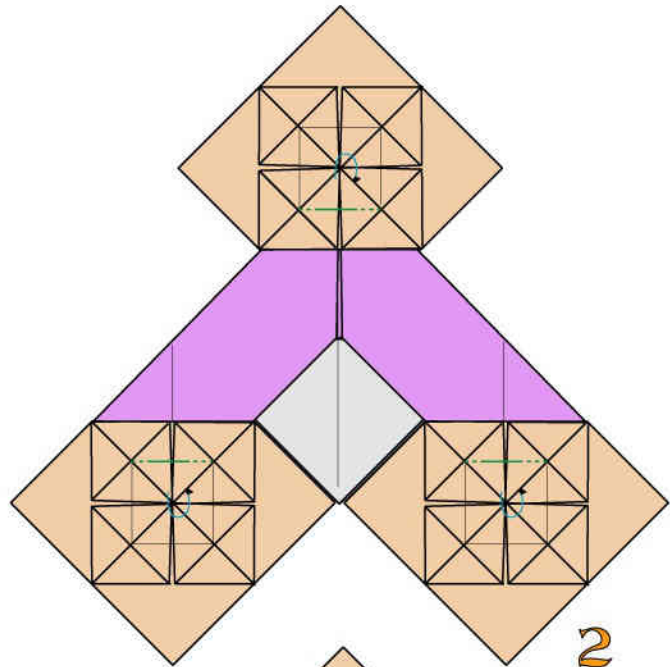

2

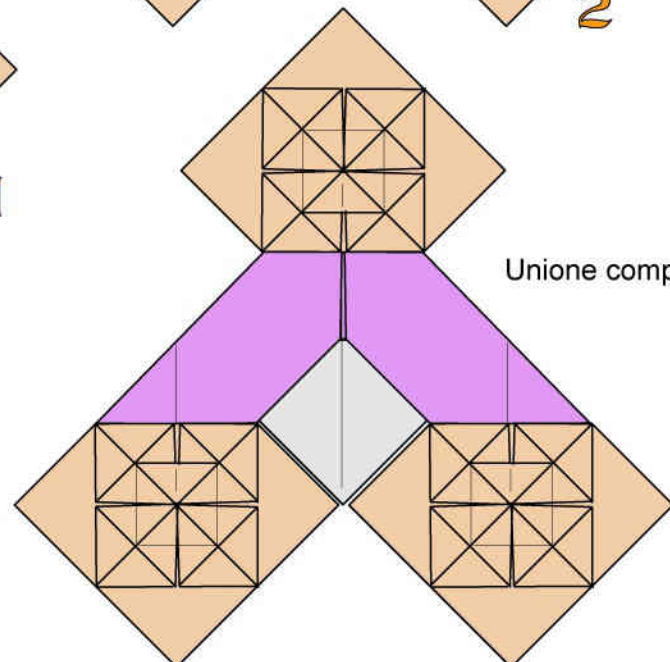

Unione completata

3

TASSELLAZIONE "A1"

MODULARE COMPATTA

Franco Pavarin 23

Si ottiene unendo moduli di bloccaggio e moduli composti formati da due moduli "A", di cui uno modificato.

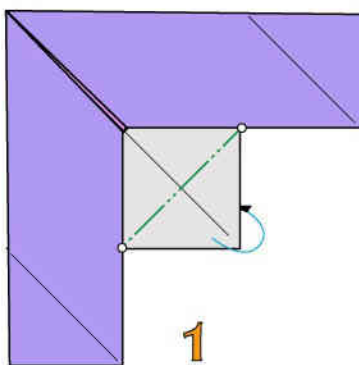
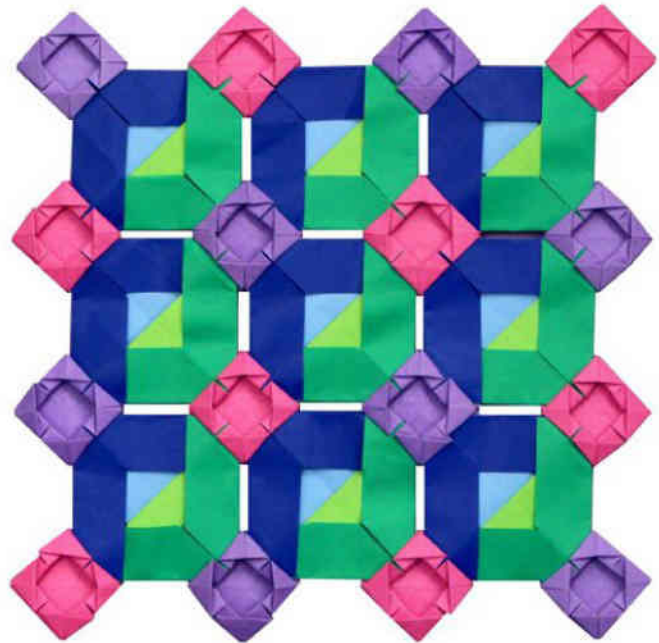

Modulo "A". 1 piega a monte

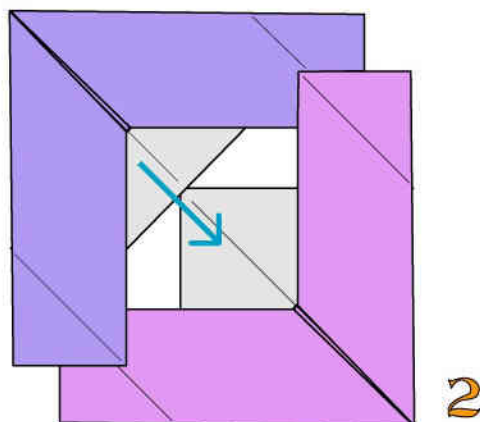

Unite il modulo "A" modificato con un modulo "A"

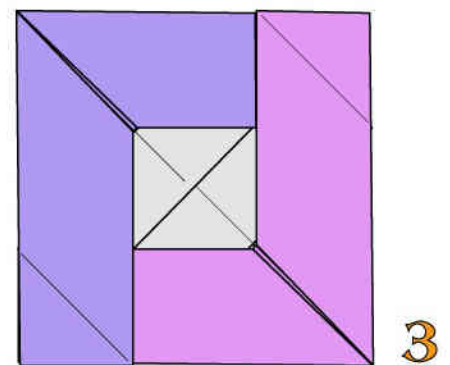

Modulo "A" composto ultimato

UNIONE DEI MODULI

Inserite il modulo composto
ento 4 moduli di bloccaggio

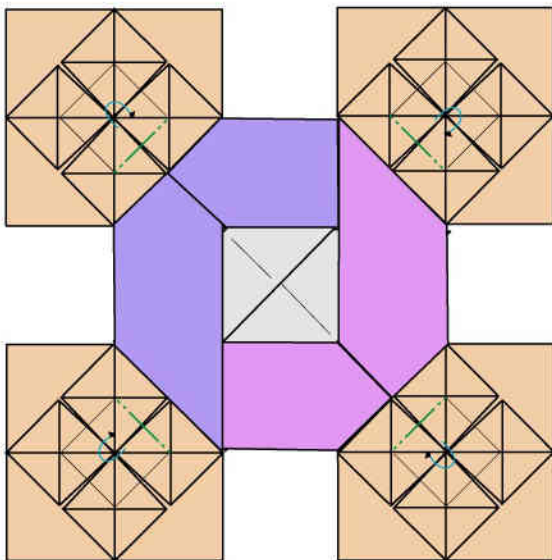
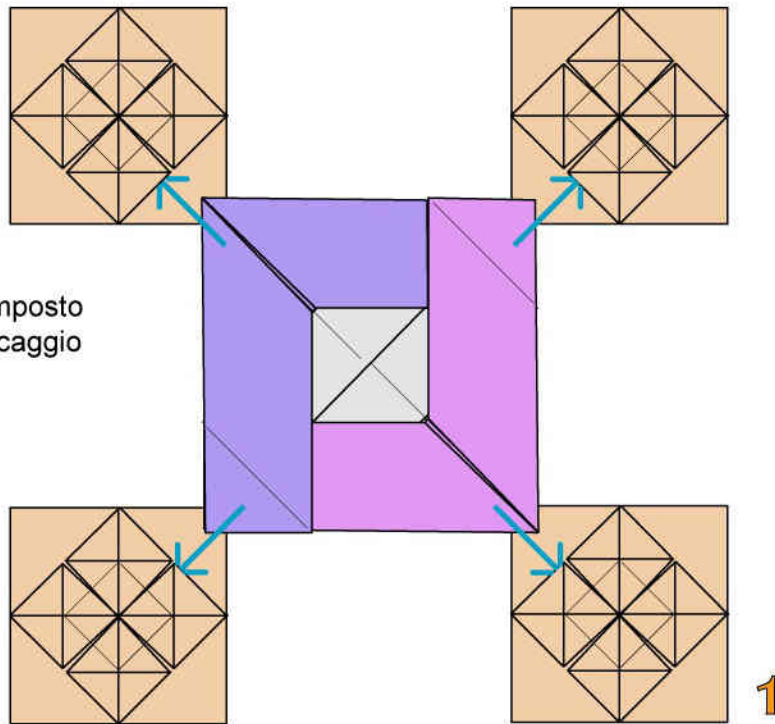

Mediante pieghe a monte bloccate l'unione

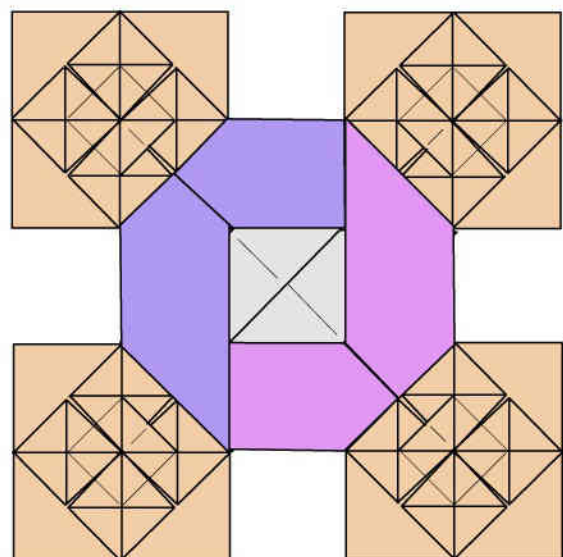

Unione completata

TASSELLAZIONE "B"

MODULARE COMPATTA

Franco Pavarin 23

Si realizza unendo moduli "B" con moduli di bloccaggio.

Adoperate carta bicolore leggera per i moduli "A" e monocolore di medio peso per i moduli di bloccaggio.

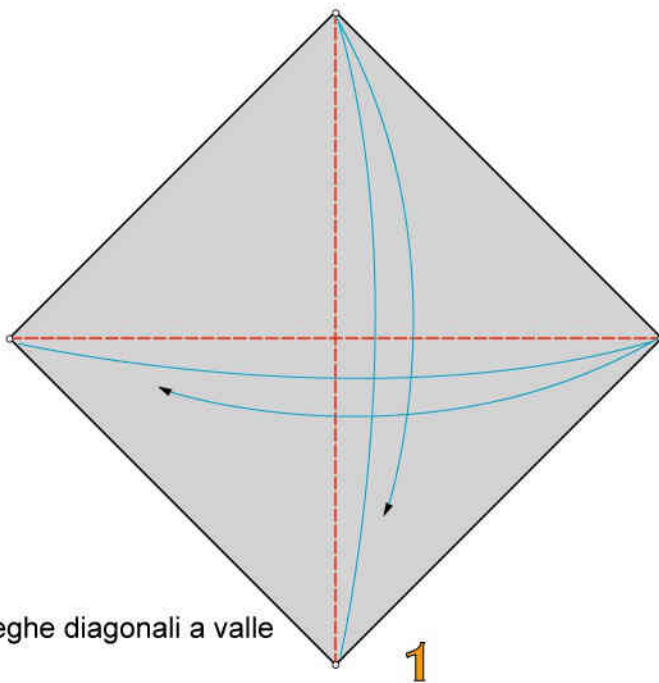
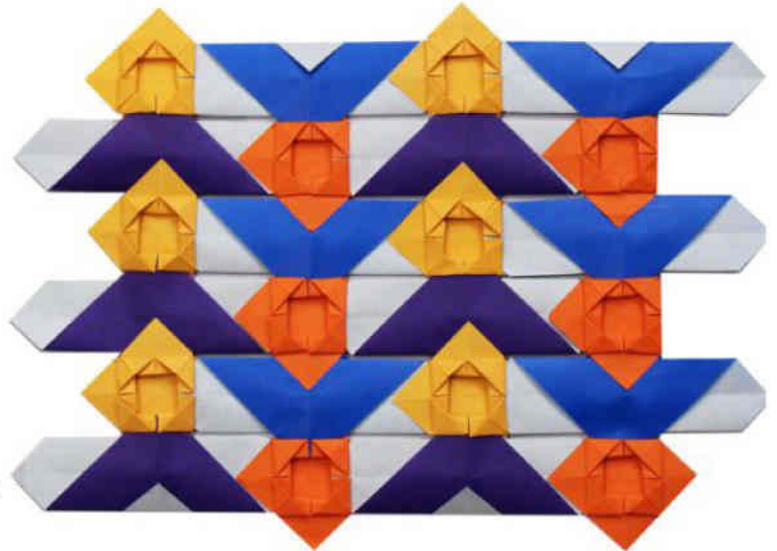

2 pieghe diagonali a valle

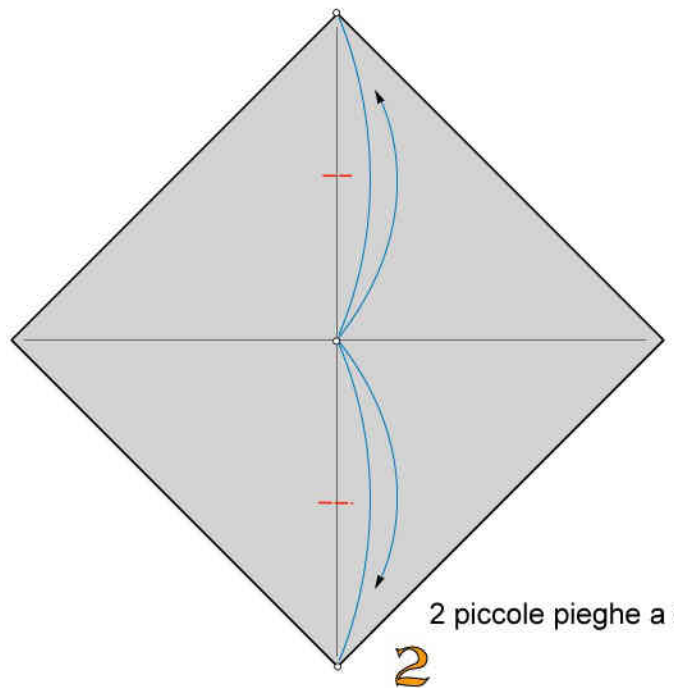

2 piccole pieghe a valle

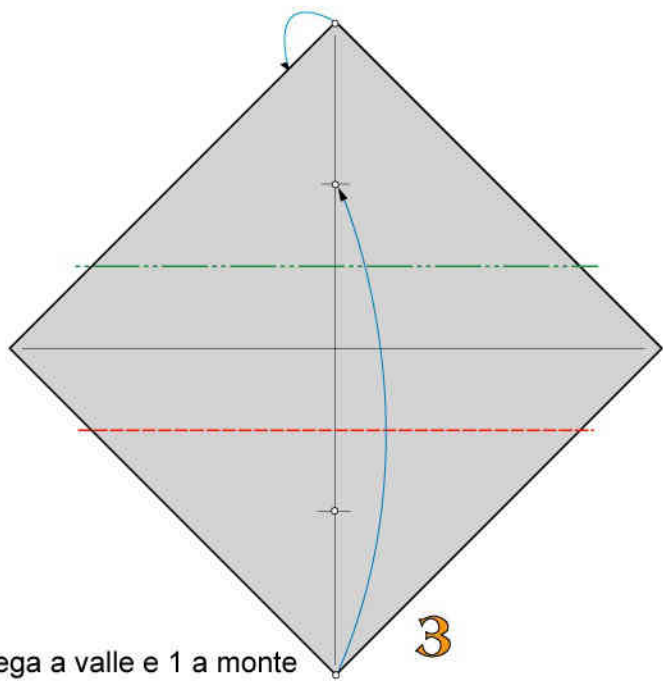

1 piega a valle e 1 a monte

3

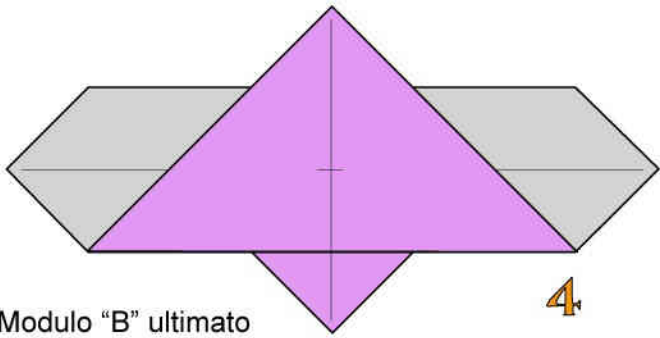

Modulo "B" ultimato

4

UNIONE DEI MODULI

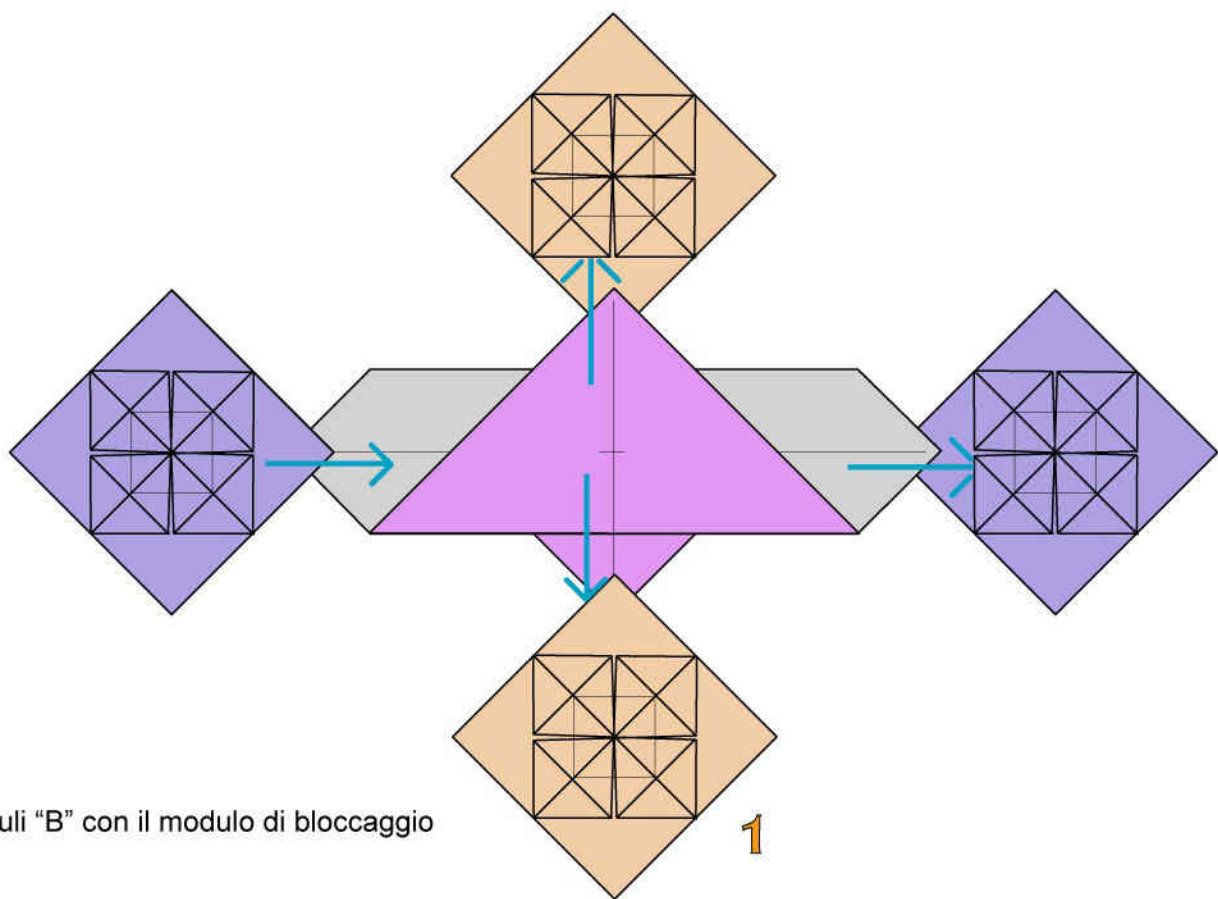

Unite 4 moduli "B" con il modulo di bloccaggio

1

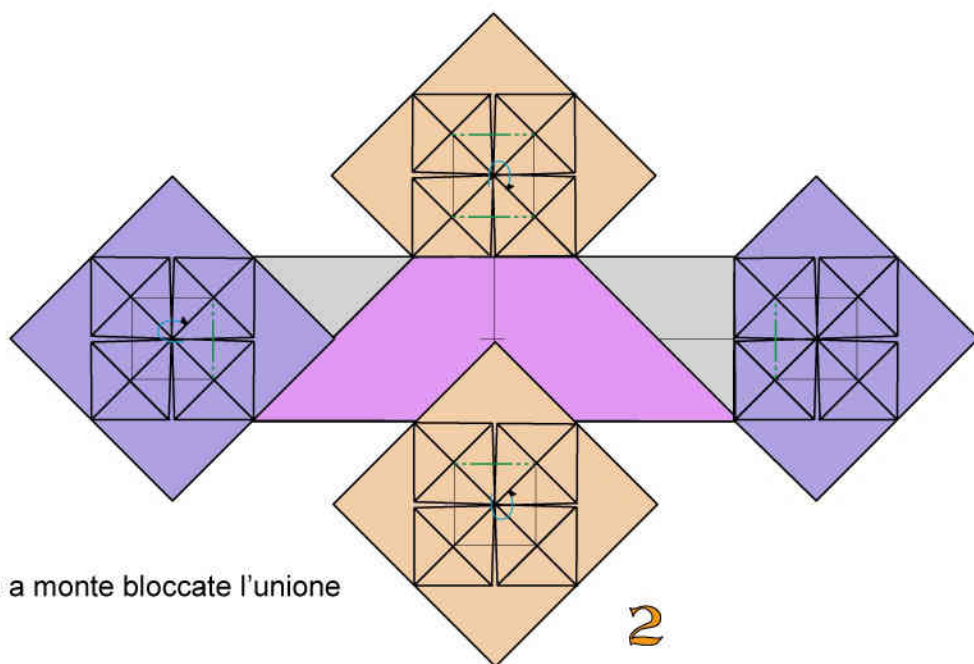

Mediante pieghe a monte bloccate l'unione

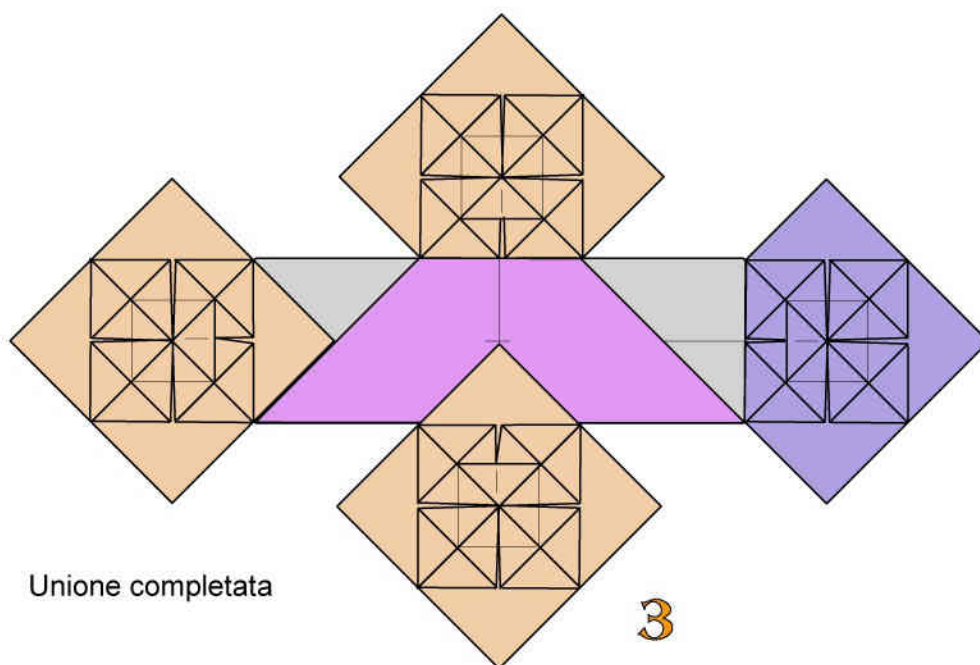

Unione completata

TASSELLAZIONE "C"

MODULARE TRAFORATA

Franco Pavarin 23

Si realizza unendo moduli "C" con moduli di bloccaggio.

Adoperate carta bicolore leggera per i moduli "C" e monocolore di medio peso per i moduli di bloccaggio

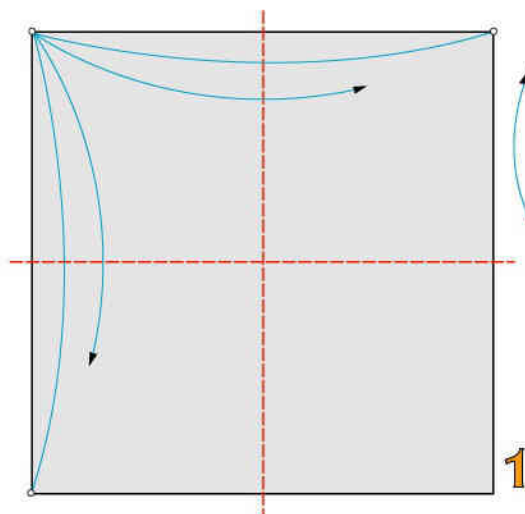
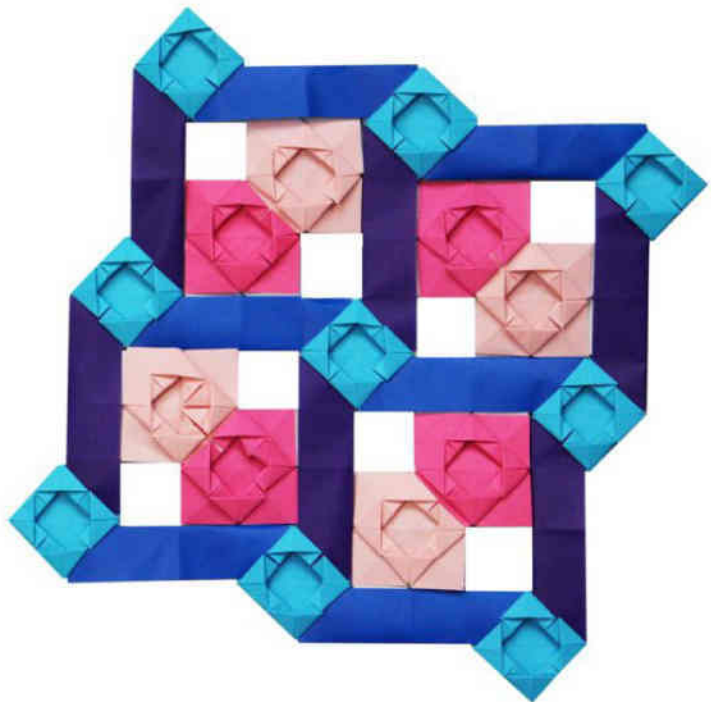

2 pieghe a valle

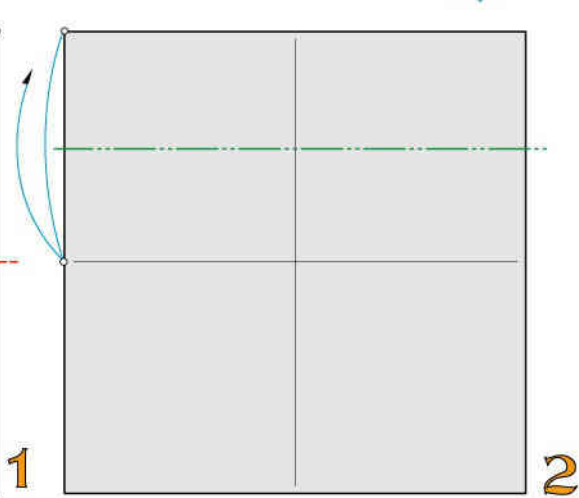

1 piega a monte

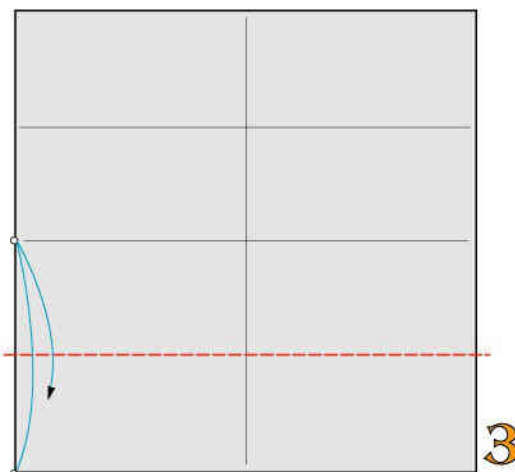

1 piega a valle

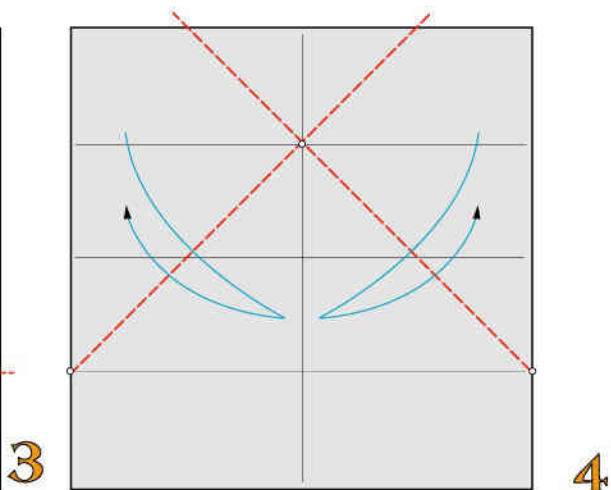

2 pieghe a valle

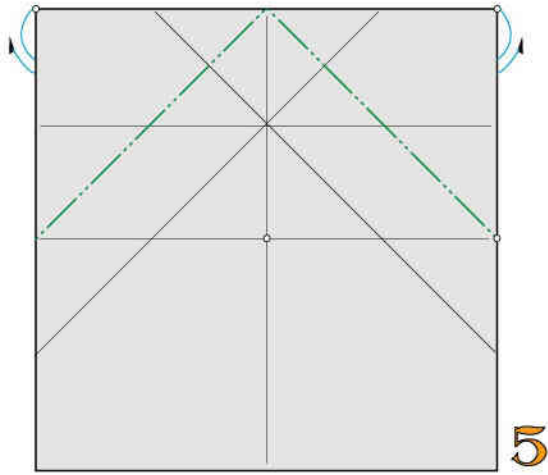

2 pieghe a monte

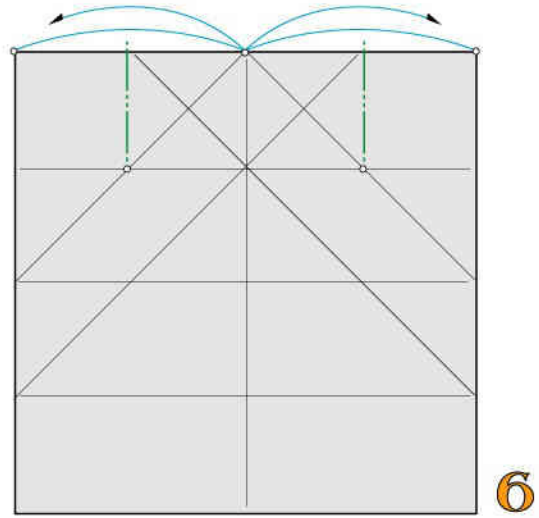

2 pieghe a monte

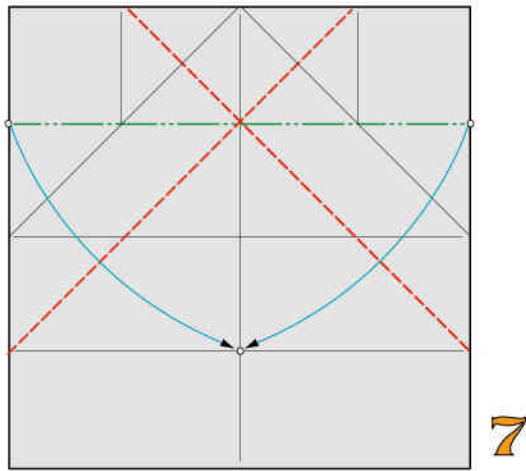

Ripiegate a valle a monte

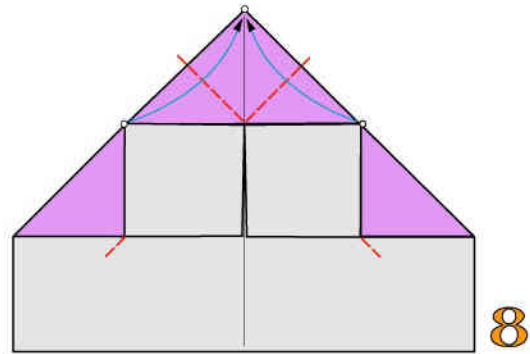

4 pieghe a valle

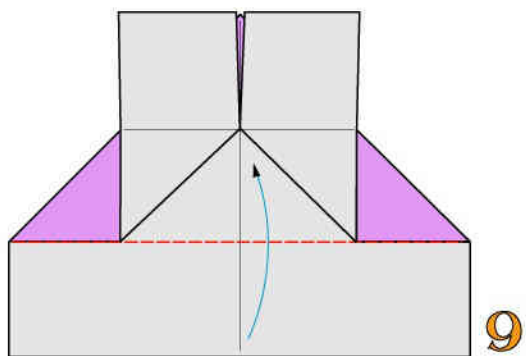

1 piega a valle

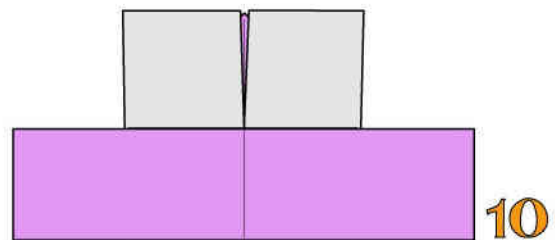

Modulo "C" ultimato

UNIONE DEI MODULI

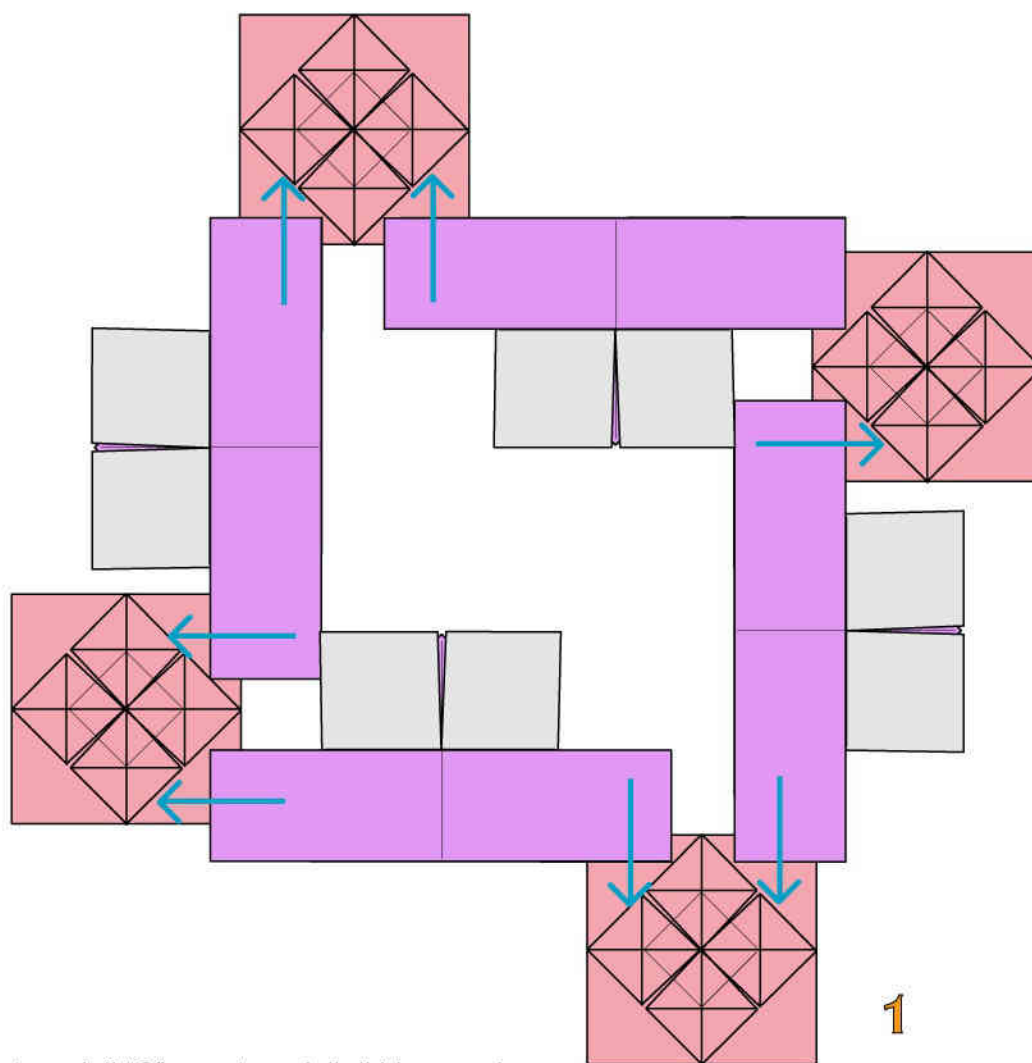

Unite 4 moduli "C" con 4 moduli di bloccaggio

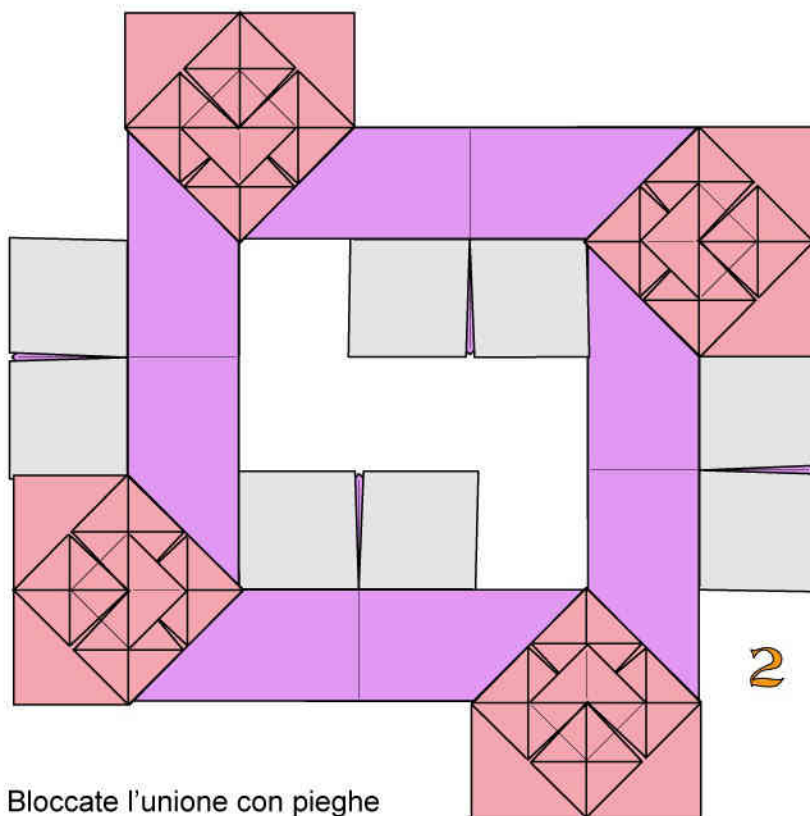

Bloccate l'unione con pieghe a monte nel solito modo

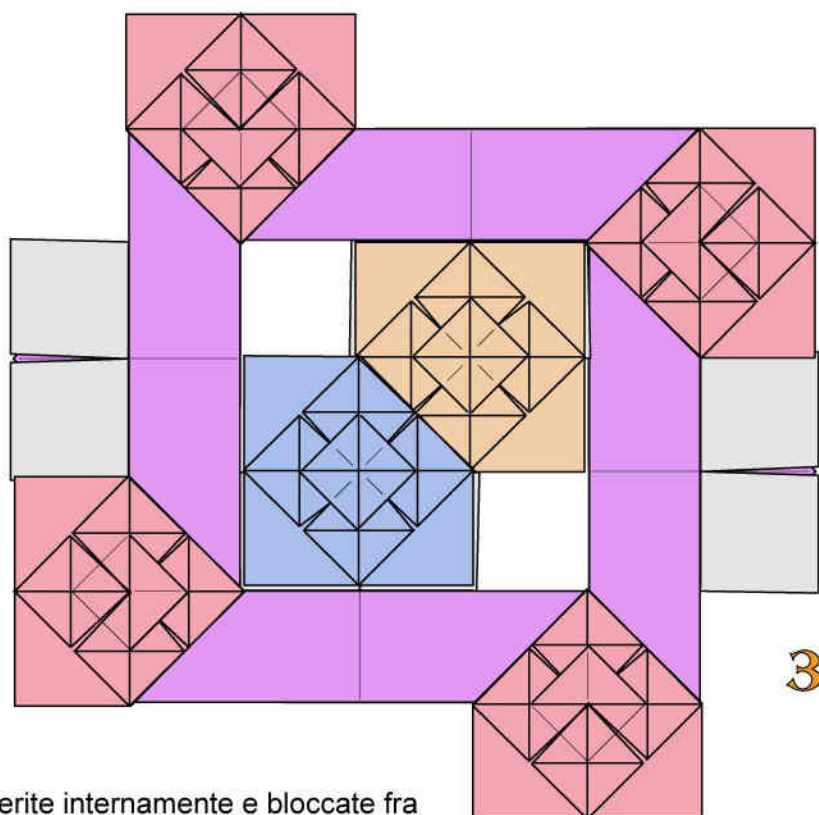

Inserite internamente e bloccate fra di loro altri 2 moduli di bloccaggio

TASSELLAZIONE "D"

MODULARE TRAFORATA

Franco Pavarin 23

Si realizza unendo moduli "D" con moduli di bloccaggio.
Adoperate carta monocolore leggera o bicolore per i moduli "D" e di medio peso per i moduli di bloccaggio

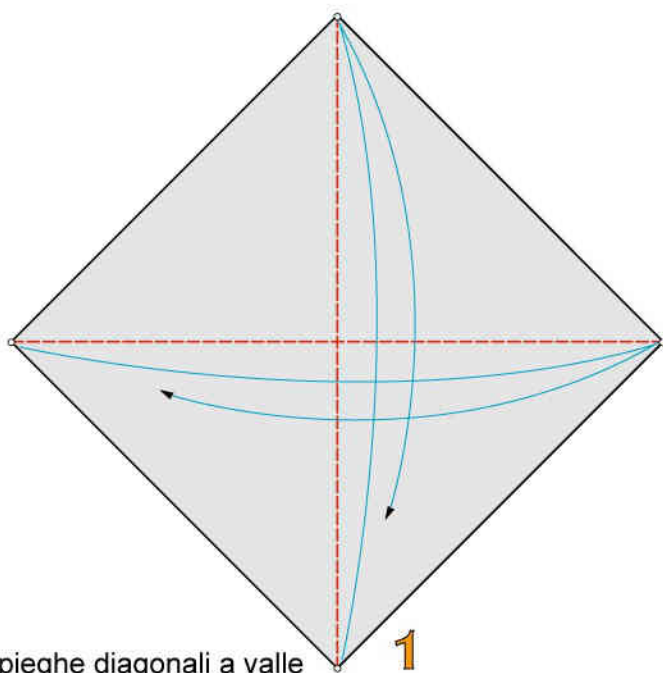
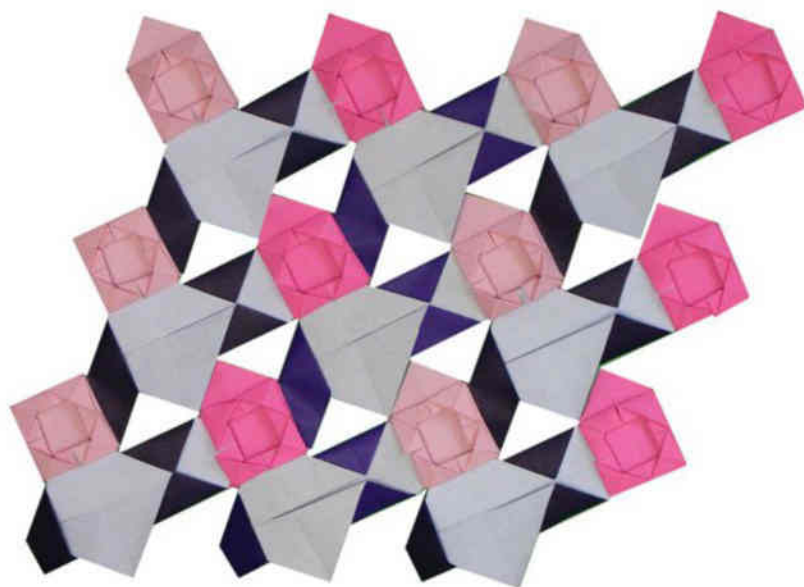

2 pieghe diagonali a valle

1

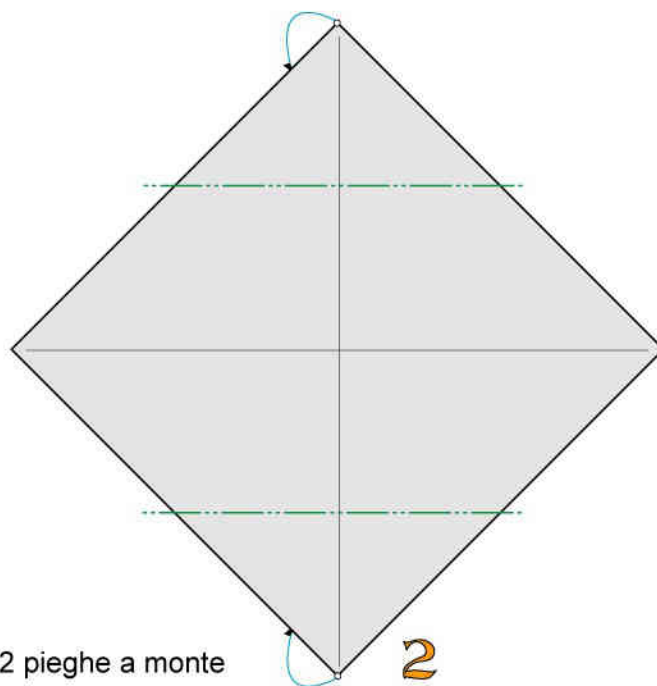

2 pieghe a monte

2

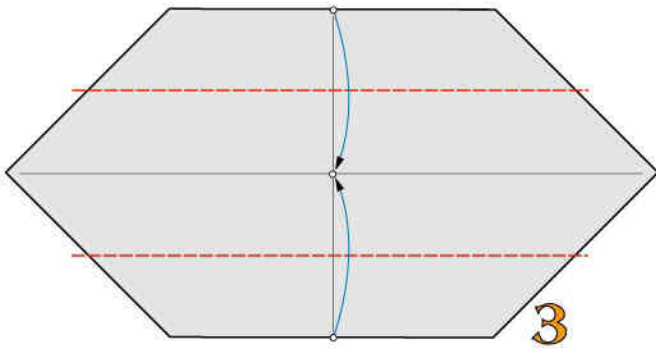

2 pieghe a valle solo sulla superficie in vista

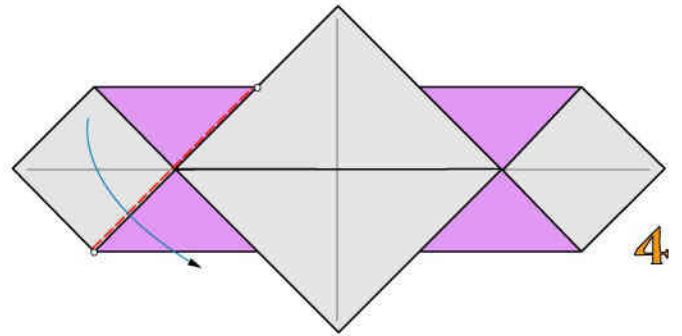

1 piega a valle

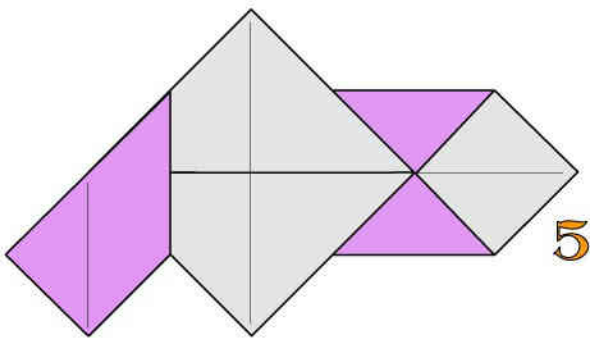

Modulo "D" ultimato

UNIONE DEI MODULI

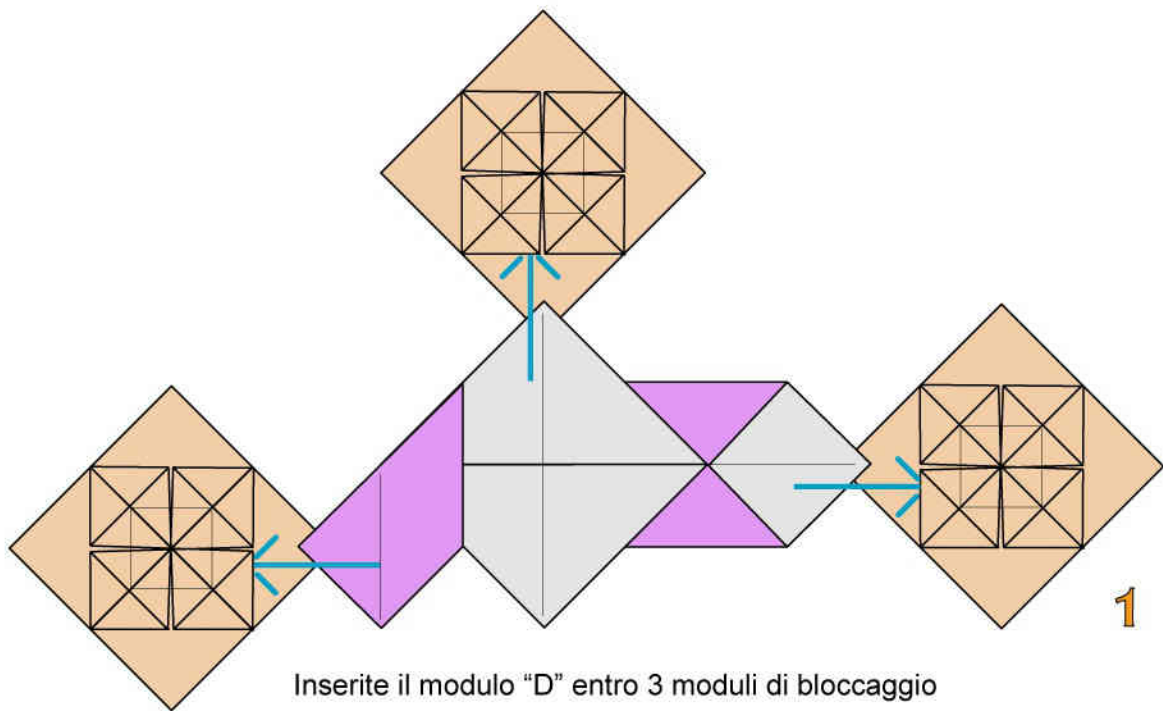

Inserite il modulo "D" entro 3 moduli di bloccaggio

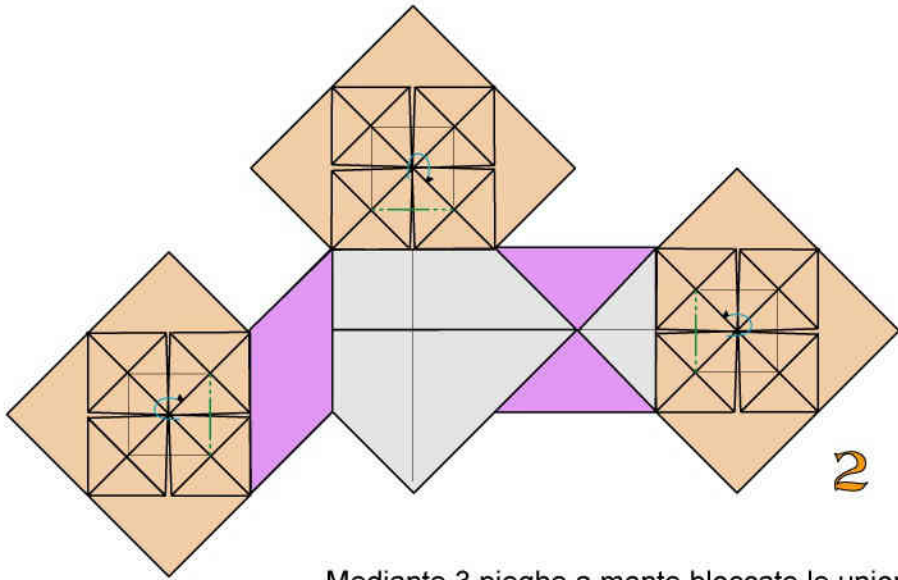

Mediante 3 pieghe a monte bloccate le unioni

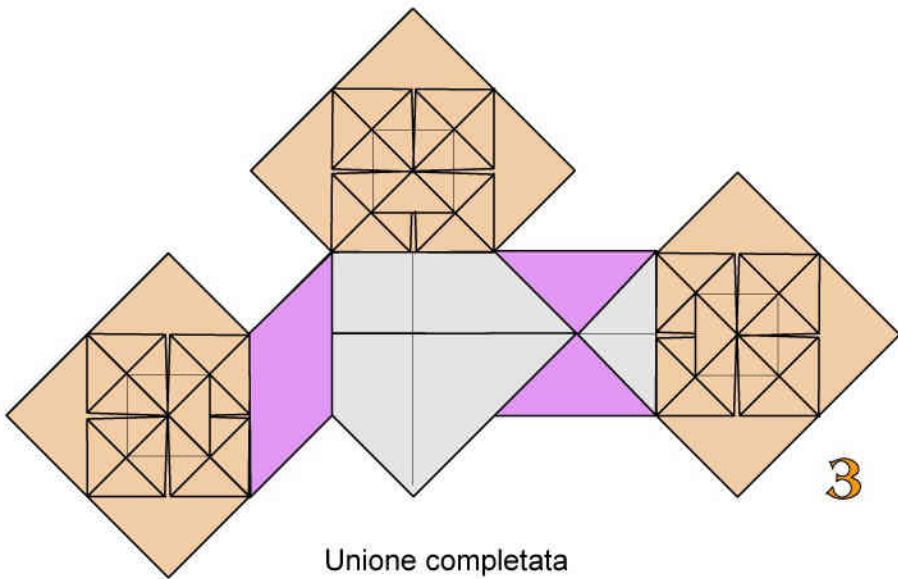

Unione completata

TASSELLAZIONE "E"

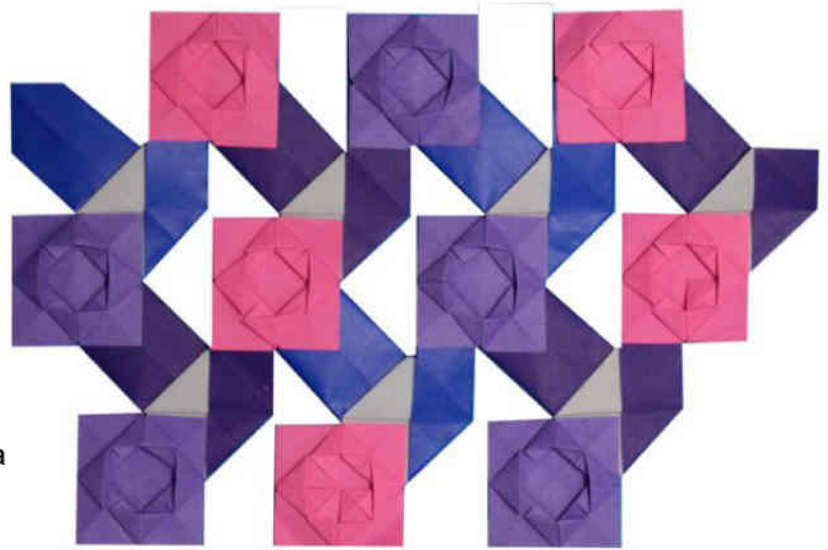

Si realizza unendo moduli "E" con moduli di bloccaggio.
Adoperate carta monocolore leggera o bicolore per i moduli "E" e di medio peso per i moduli di bloccaggio

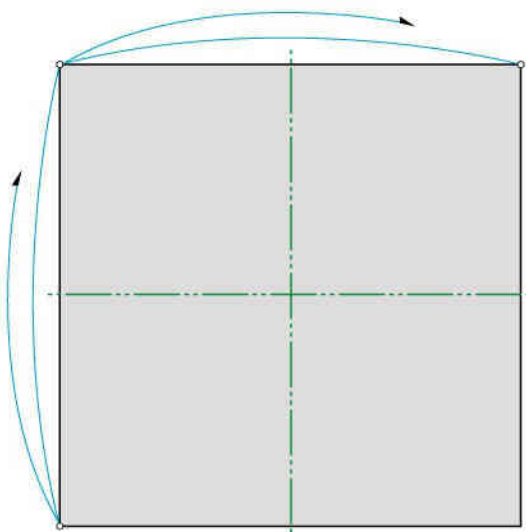

2 pieghe a monte

1

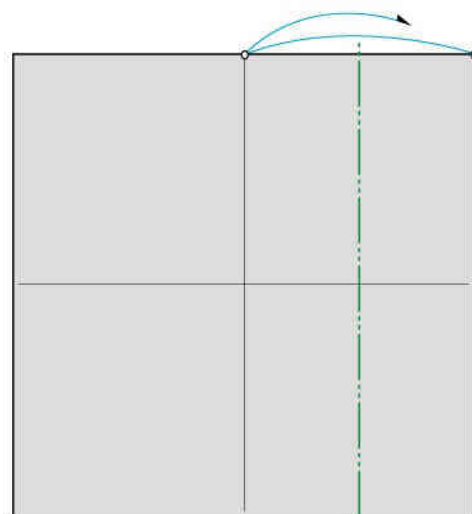

2

1 piega a monte

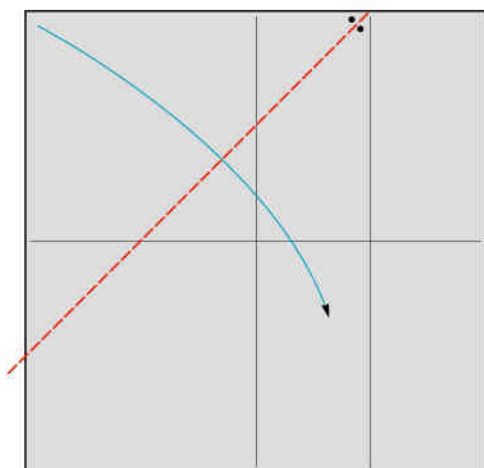

3

1 piega bisettrice a valle

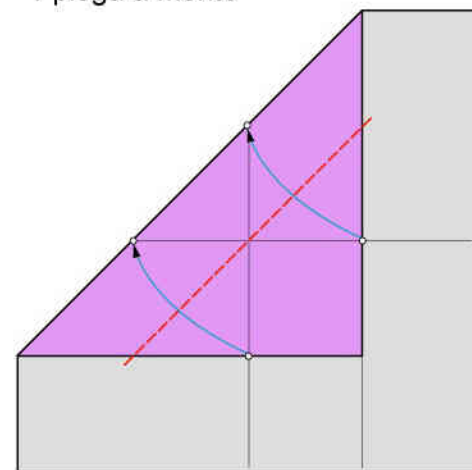

4

1 piega a valle

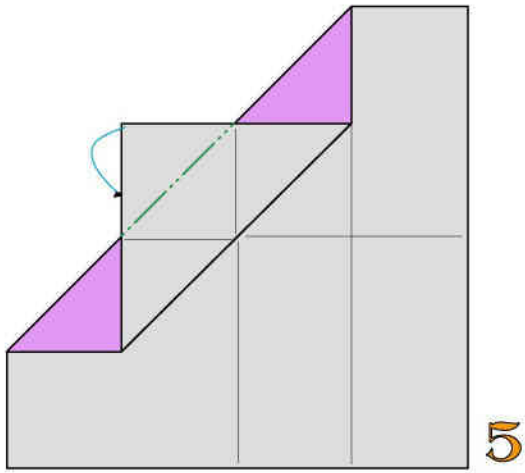

1 piega a monte

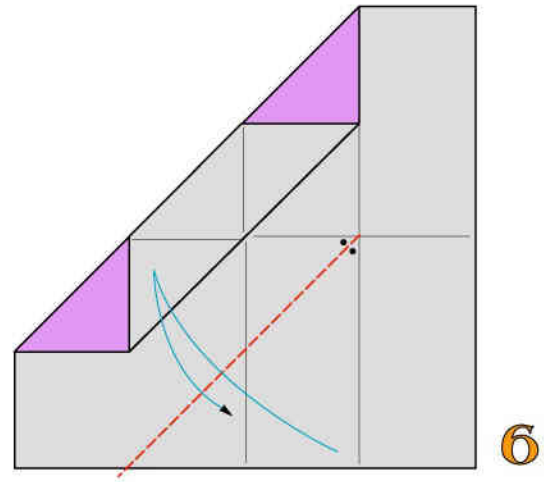

1 piega bisettrice a valle

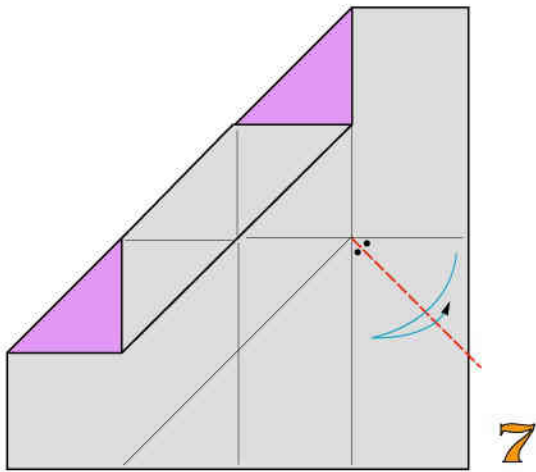

1 piega bisettrice a valle

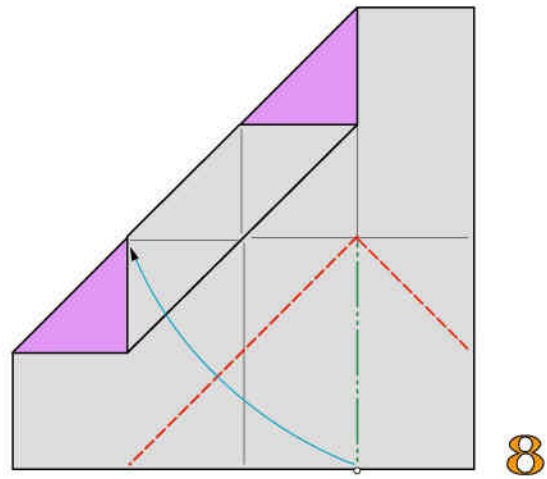

Ripiegate a valle e a monte

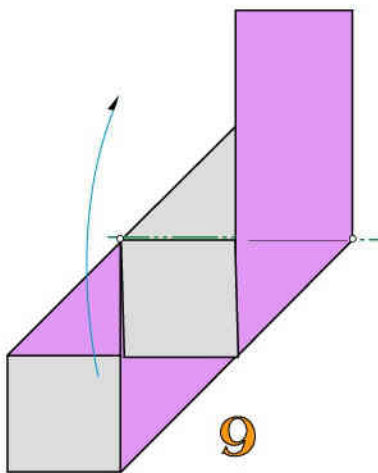

1 piega a monte

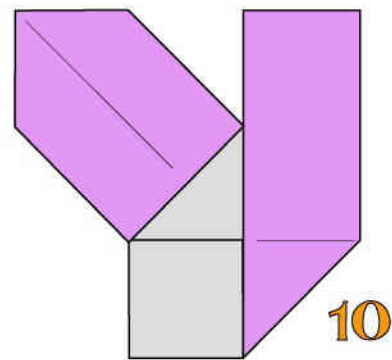

Modulo "E" ultimato

UNIONE DEI MODULI

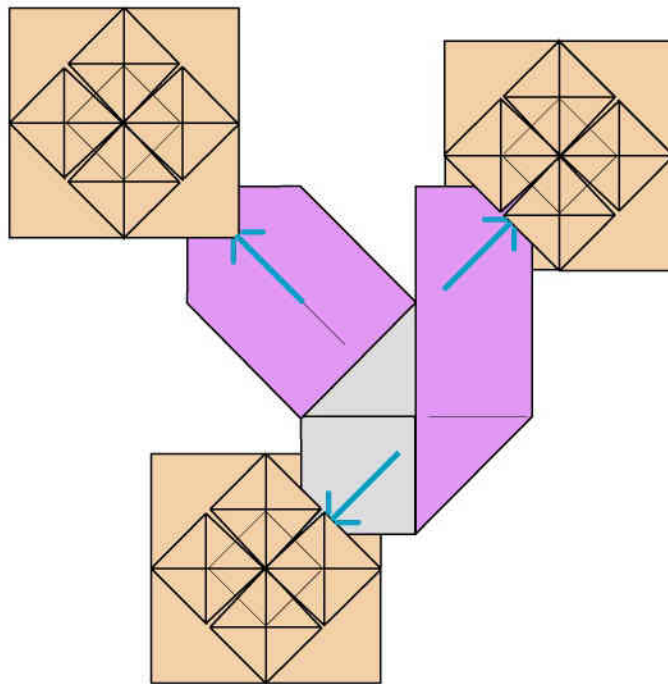

Inserite il modulo "E" entro 3 moduli di bloccaggio¹

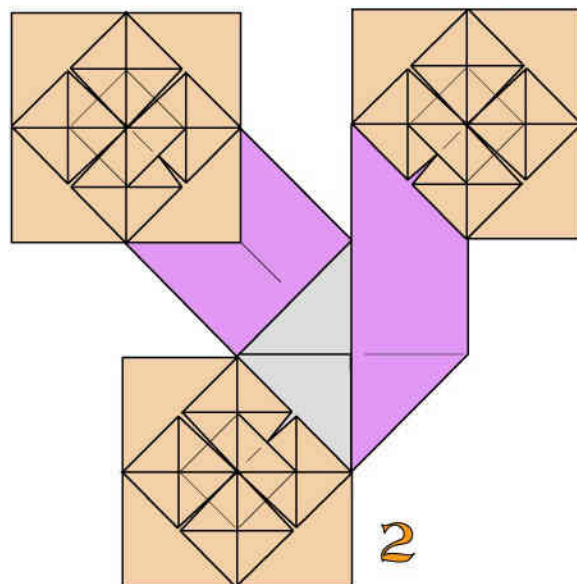

Bloccate l'unione nel solito modo con pieghe a monte. Unione completata

TASSELLAZIONE "€1"

MODULARE TRAFORATA

Franco Pavarin 23

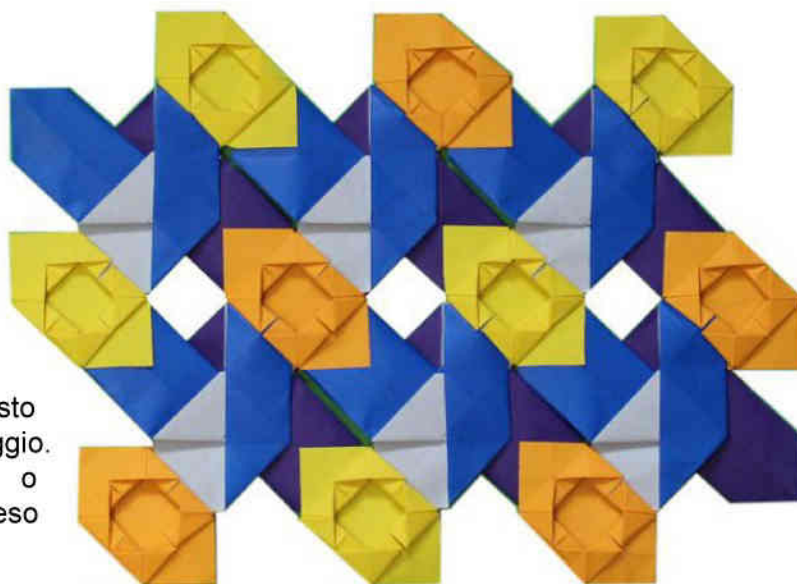

Si realizza unendo un modulo composto da 2 moduli "E" con 1 modulo di bloccaggio. Adoperate carta monocolore leggera o bicolore per i moduli "E" e di medio peso per i moduli di bloccaggio

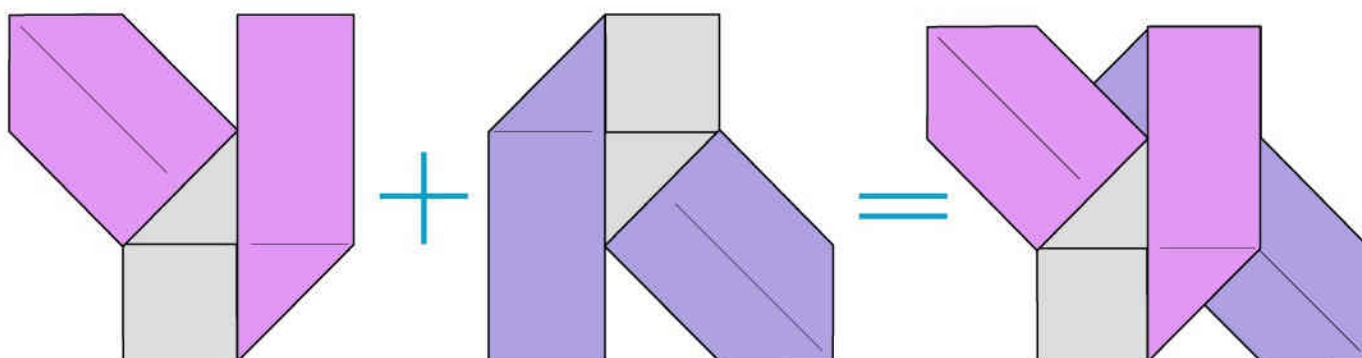

UNIONE DEI MODULI

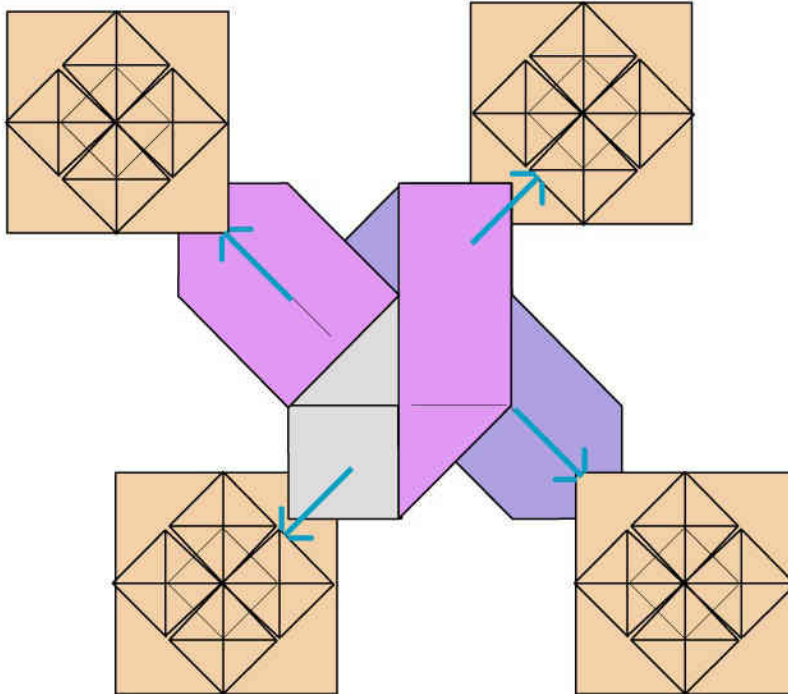

Inserite il modulo "E" entro 4 moduli di bloccaggio

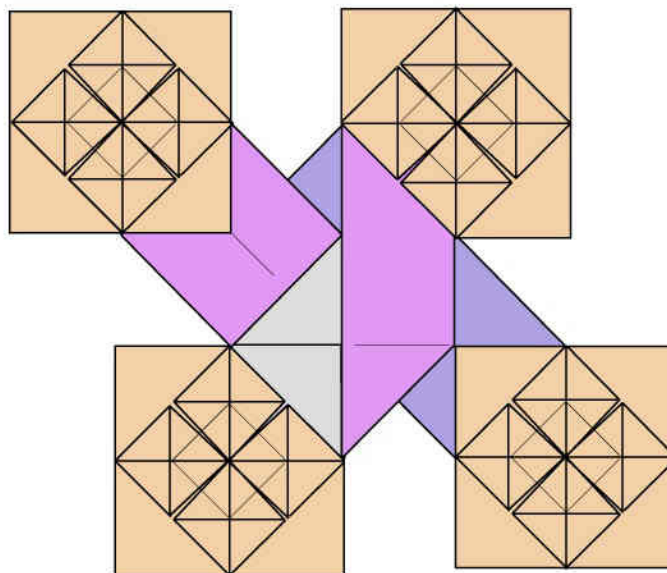

Bloccate l'unione nel solito modo con pieghe a monte. Unione completata

TASSELLAZIONE "F"

MODULARE TRAFORATA

Franco Pavarin 23

Si realizza unendo moduli "F" con moduli di bloccaggio.

Adoperare carta bicolore leggera per i moduli "F" e monocolori di medio peso per i moduli di bloccaggio.

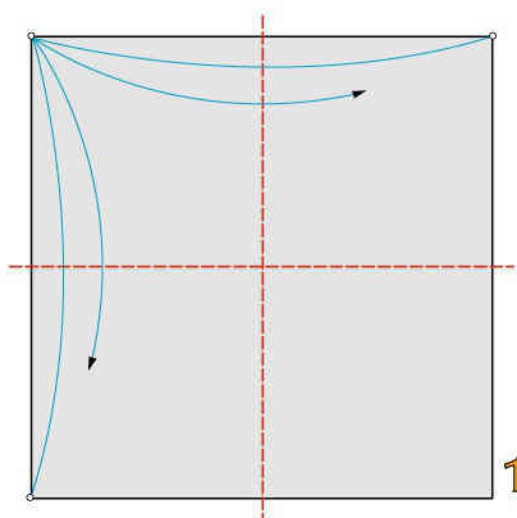
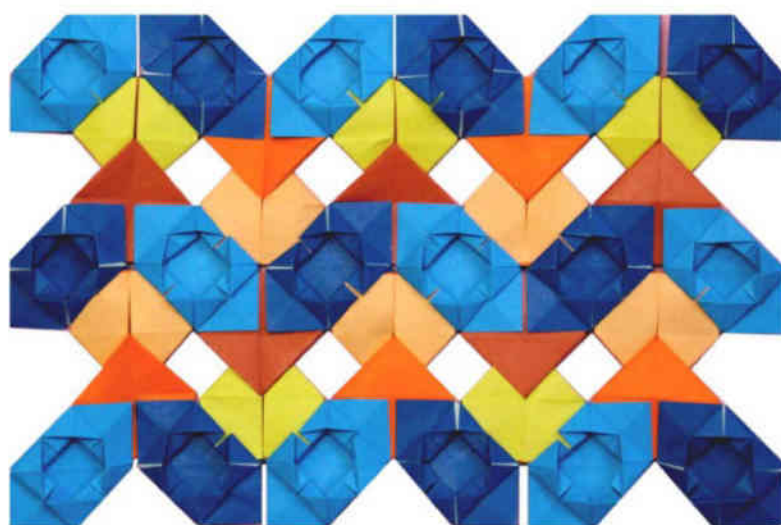

2 pieghe a valle

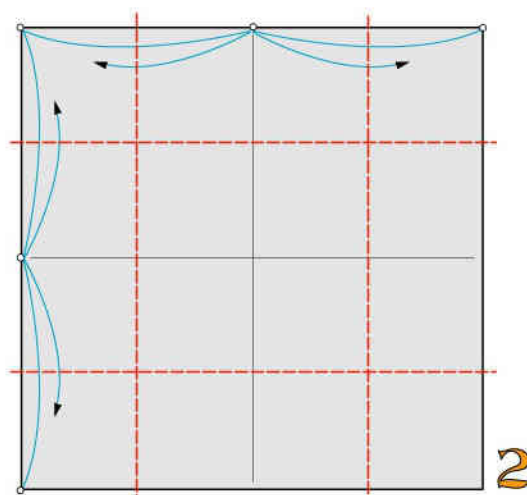

4 pieghe a valle

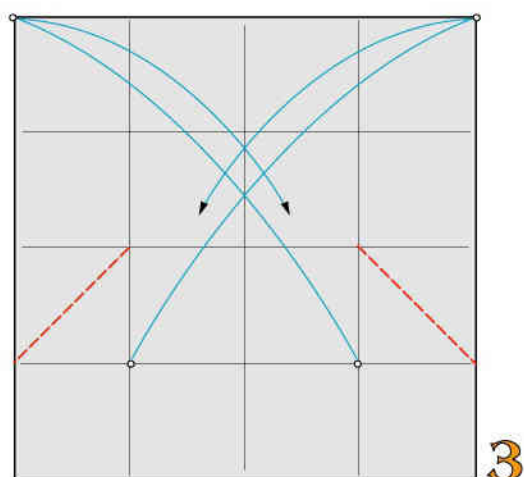

2 pieghe diagonali a valle

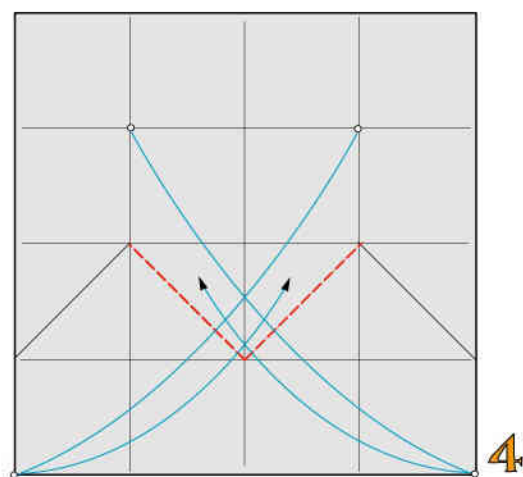

2 pieghe diagonali a valle

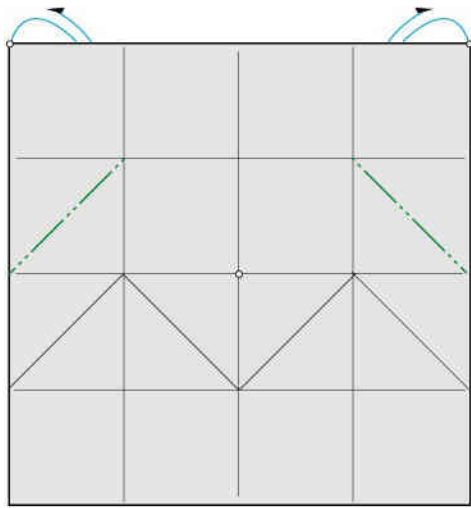

2 pieghe diagonali a monte

5

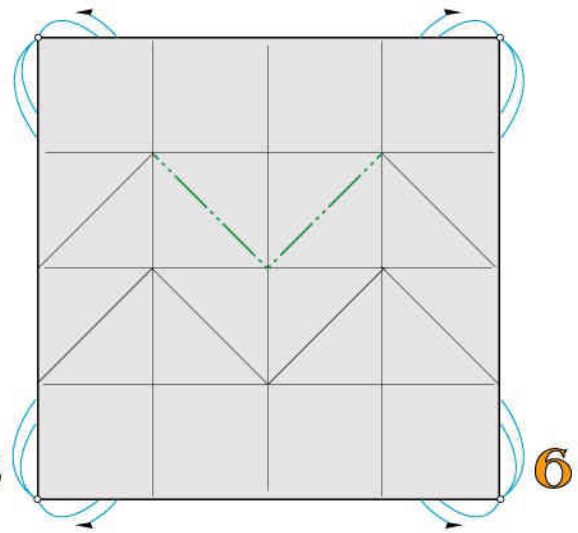

2 pieghe diagonali a monte

6

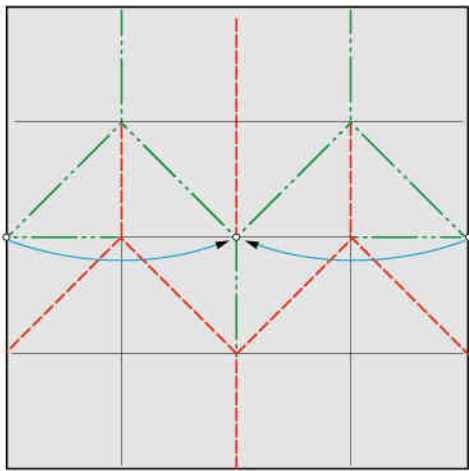

7

Ripiegate a valle e a monte

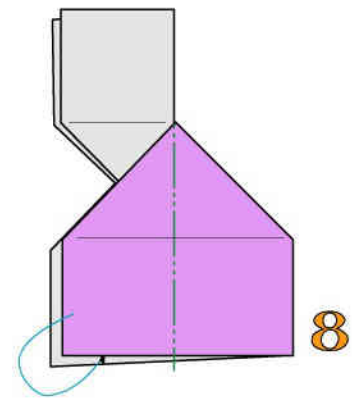

8

1 piega a monte

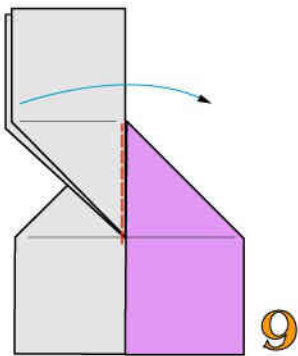

9

1 piega a valle

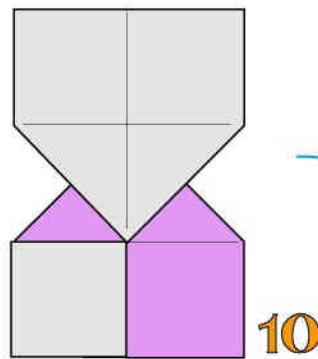

10

Modulo "F" ultimato.
Ribaltate

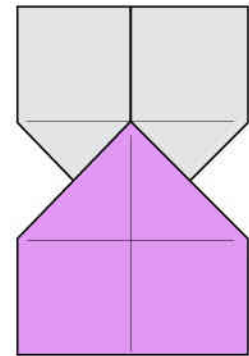

UNIONE DEI MODULI

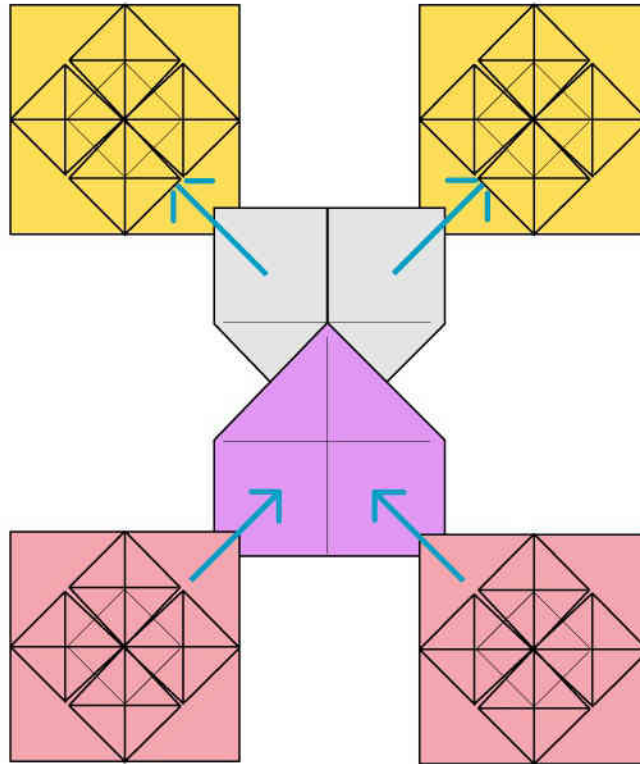

Unite 1 modulo "F" con 4 moduli di bloccaggio

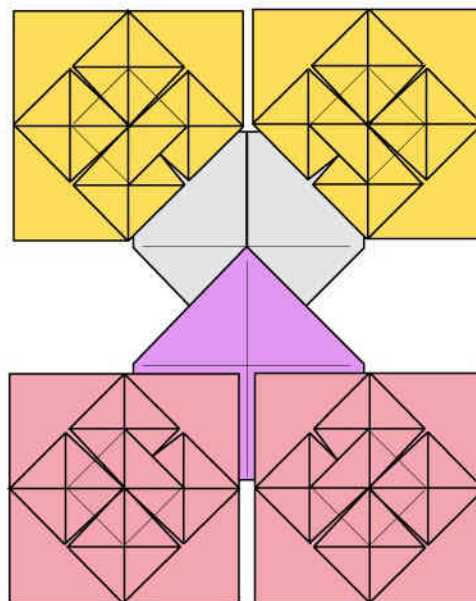

Mediante 4 pieghe a monte bloccate
l'unione nel solito modo

TASSELLAZIONE "G"

MODULARE TRAFORATA

Franco Pavarin 23

Si realizza unendo moduli "G" con
moduli di bloccaggio.
Adoperate carta bicolore leggera
per i moduli "G" e monocolori di
medio peso per i moduli di bloccaggio

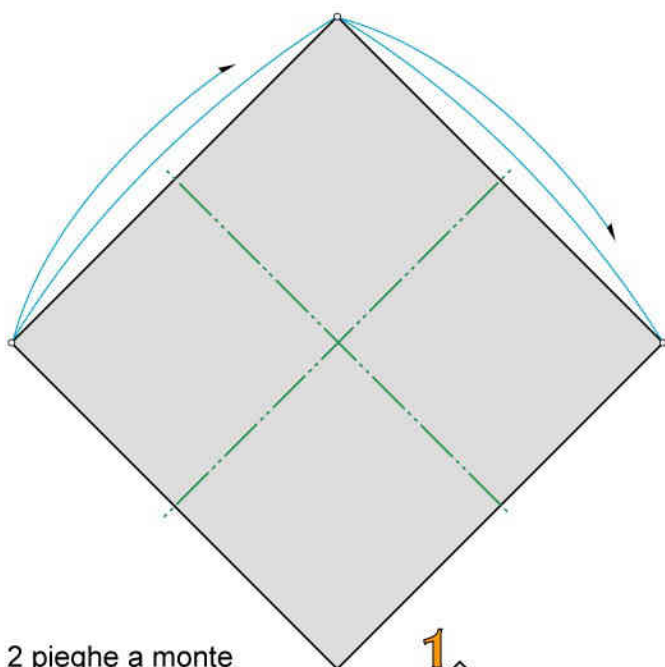
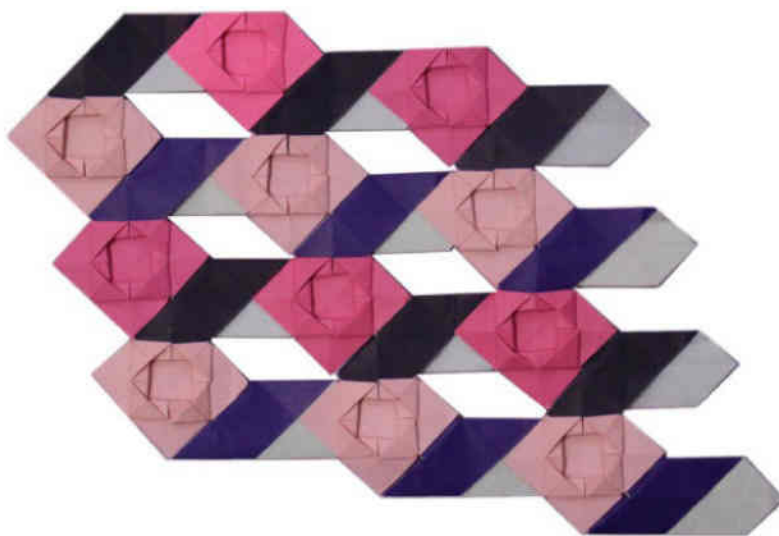

2 pieghe a monte

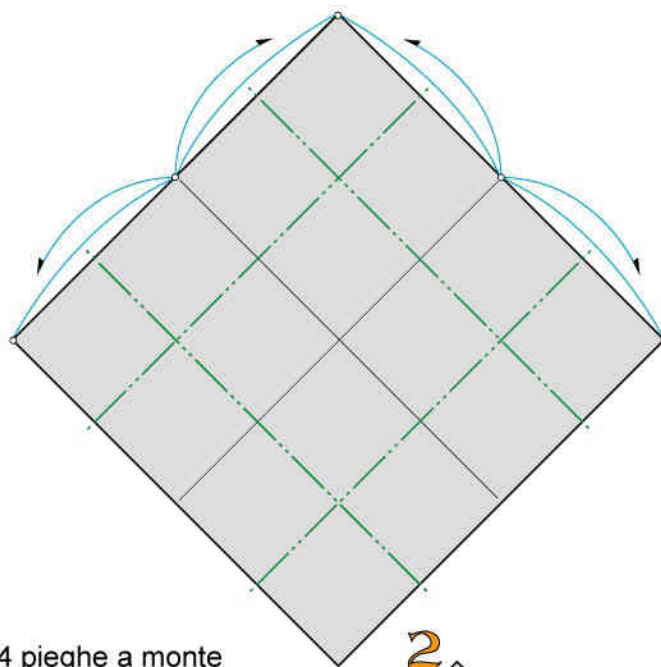

4 pieghe a monte

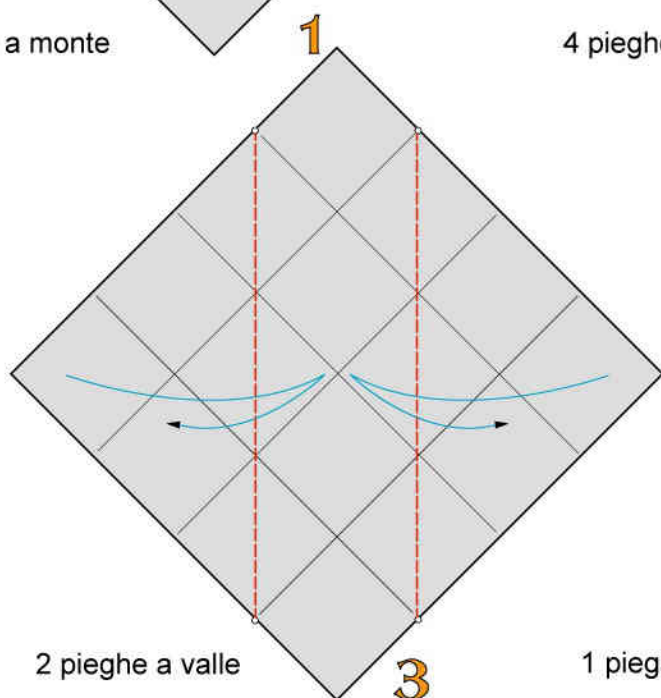

2 pieghe a valle

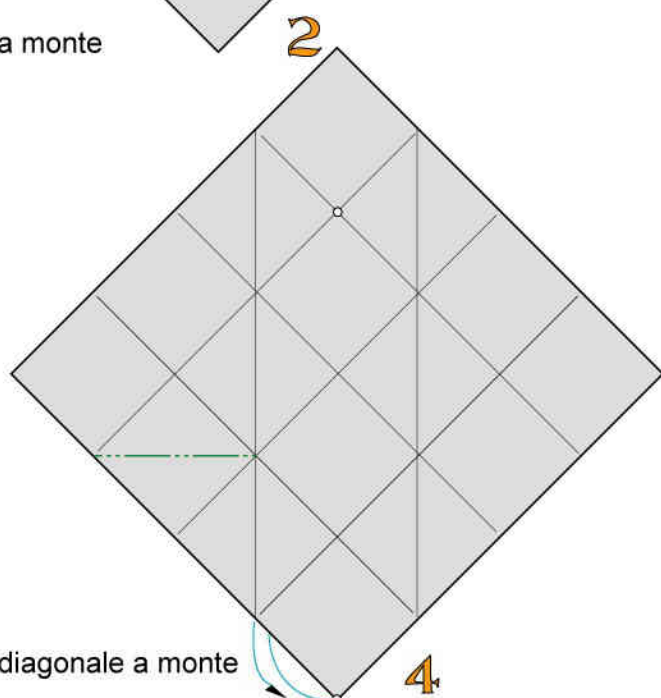

1 piega diagonale a monte

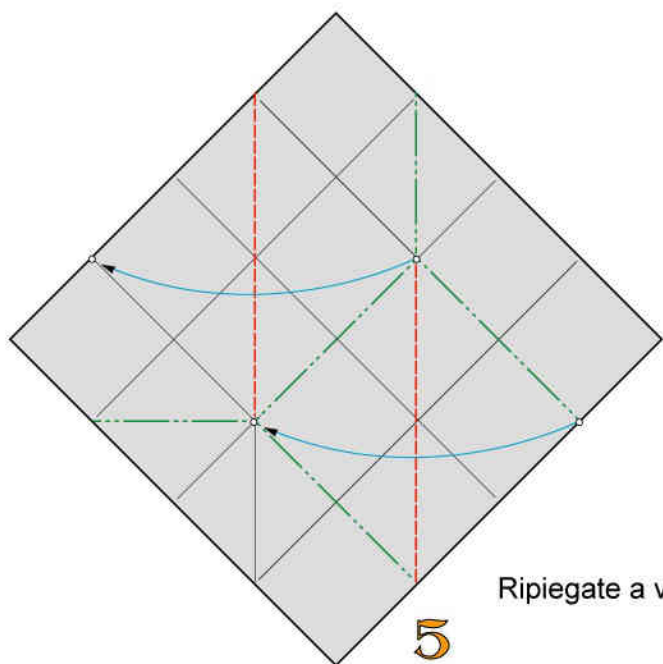

5

Ripiegate a valle e a monte

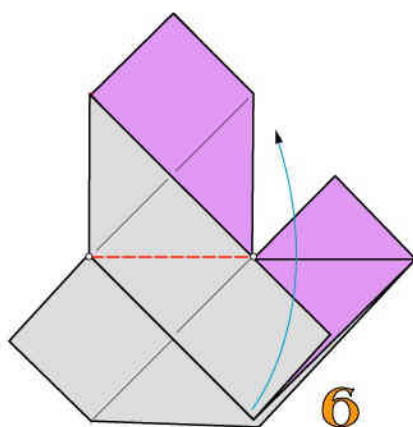

6

1 piega a valle

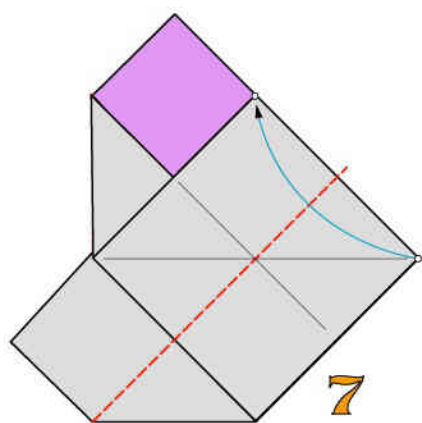

7

1 piega a valle

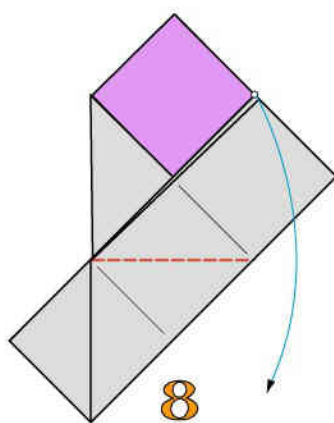

8

1 piega a valle

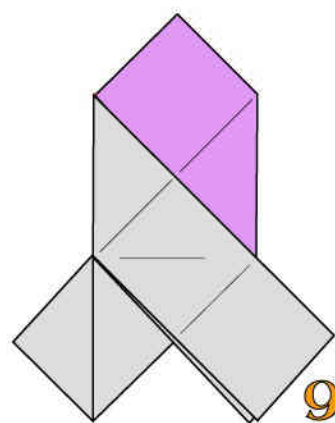

9

Ribaltate

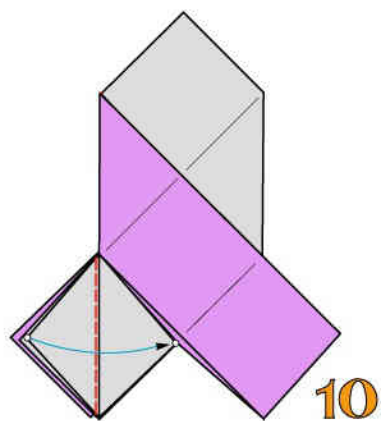

10

1 piega a valle

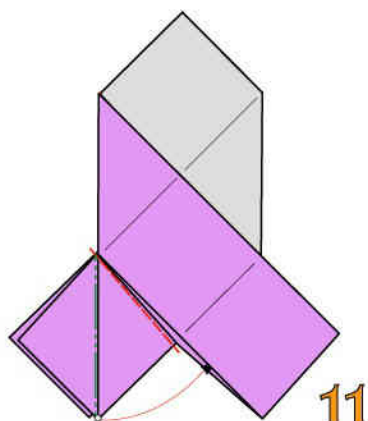

11

1 piega a monte e intascate

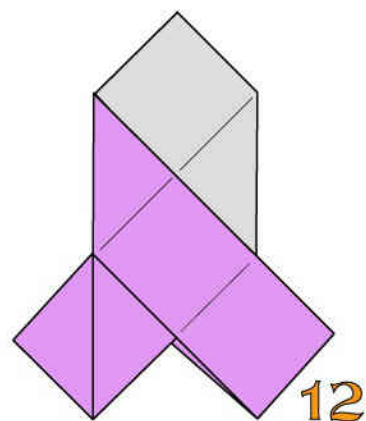

12

Modulo "G" ultimato

UNIONE DEI MODULI

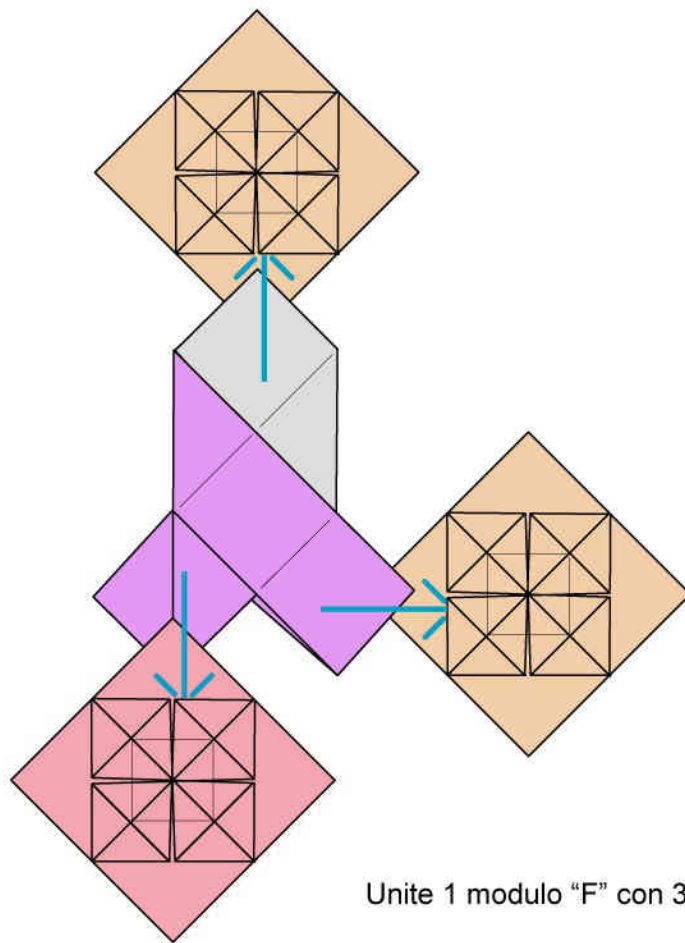

Unite 1 modulo "F" con 3 moduli di bloccaggio

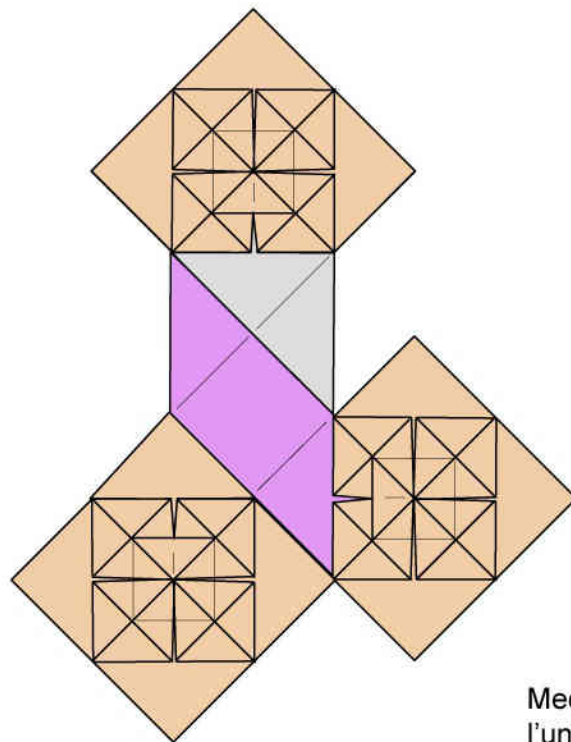

Mediante 4 pieghe a monte bloccate l'unione nel solito modo

TASSELLAZIONE "G1"

MODULARE COMPATTA

Franco Pavarin 23

Si realizza unendo un modulo composto da 2 moduli "G" con 1 modulo di bloccaggio.
Adoperate carta monocolore leggera o bicolore per i moduli "G" e di medio peso per i moduli di bloccaggio

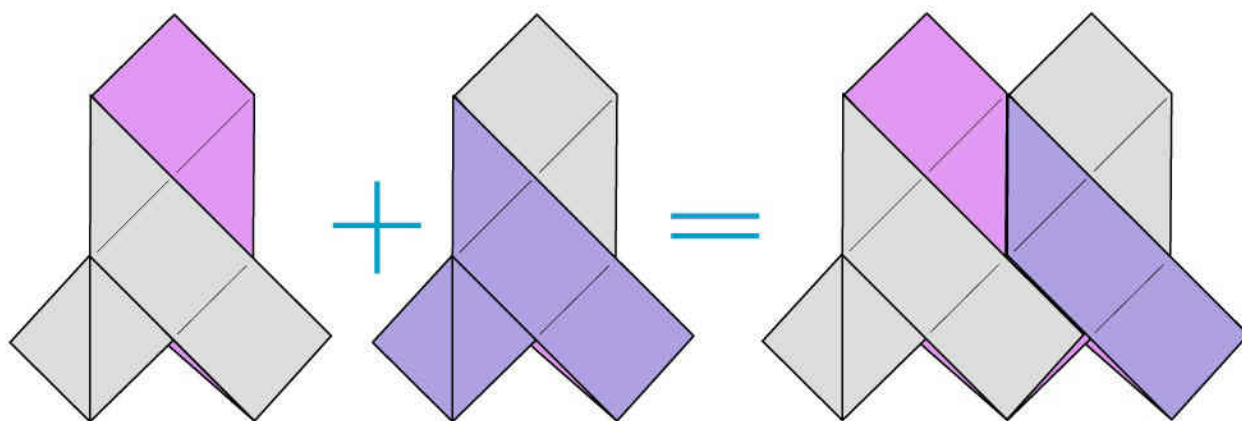
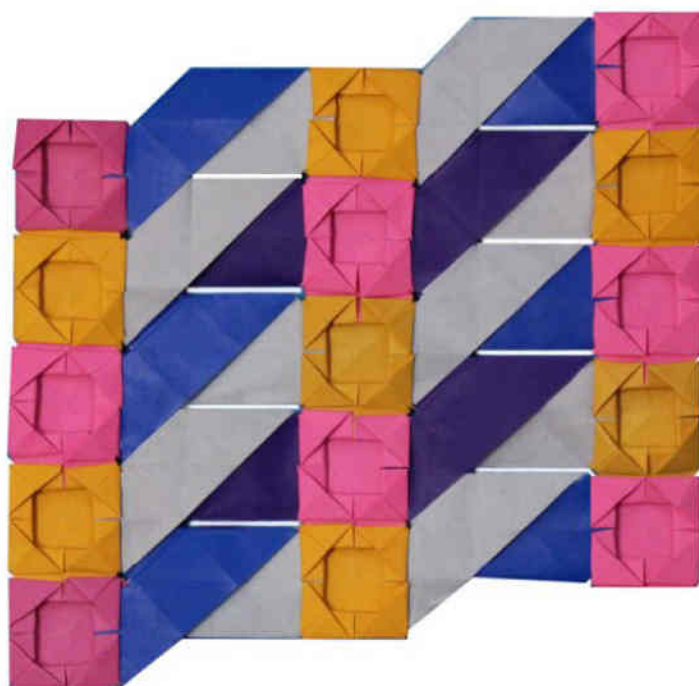

Unite 1 modulo "G" ribaltato con uno diritto

UNIONE DEI MODULI

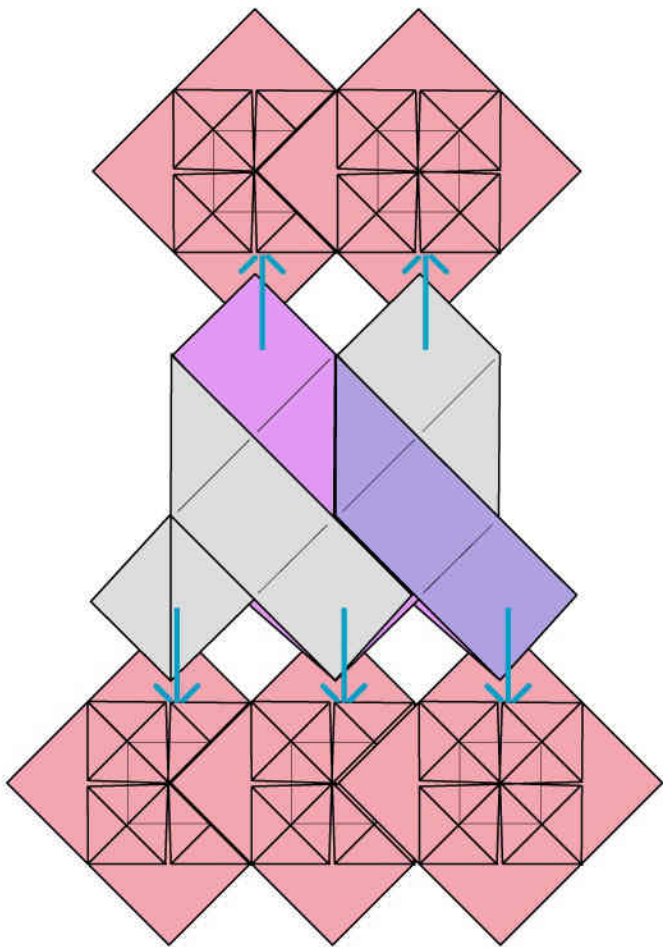

Inserite il modulo composto "E1"
entro 4 moduli di bloccaggio

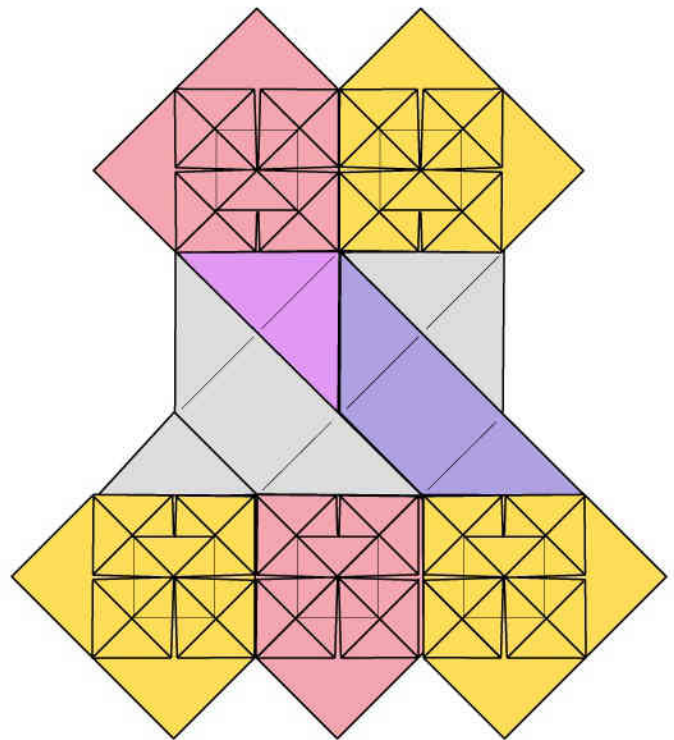

Bloccate l'unione e unite fra loro nel
solito modo i moduli di bloccaggio con
pieghe a monte. Unione completata

TASSELLAZIONE "H"

MODULARE TRAFORATA

Franco Pavarin 23

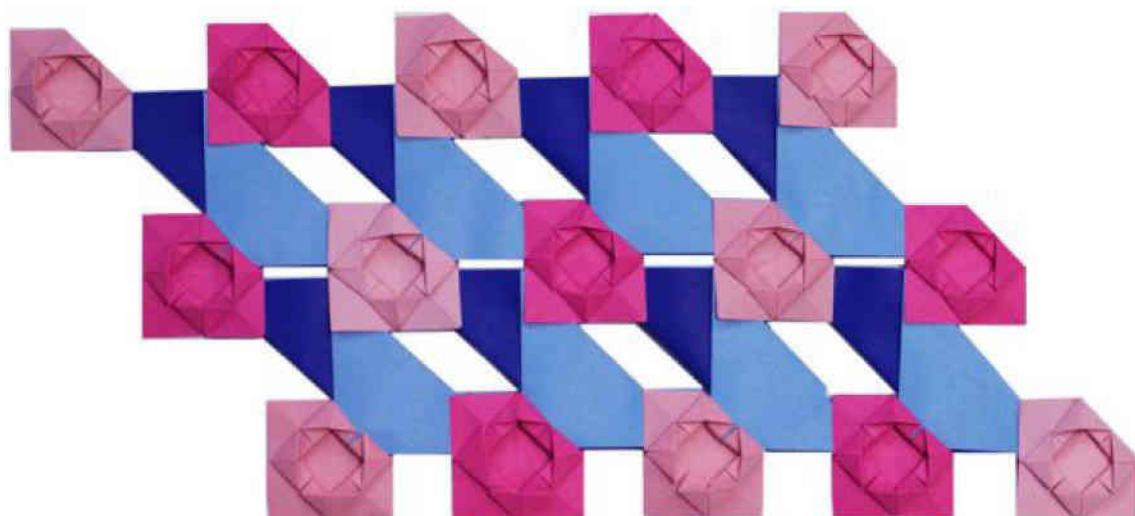

Il modulo "H" si costruisce con un foglio rettangolare 2x1 di superficie doppia di quella del modulo di bloccaggio, meglio se bicolore di medio peso.

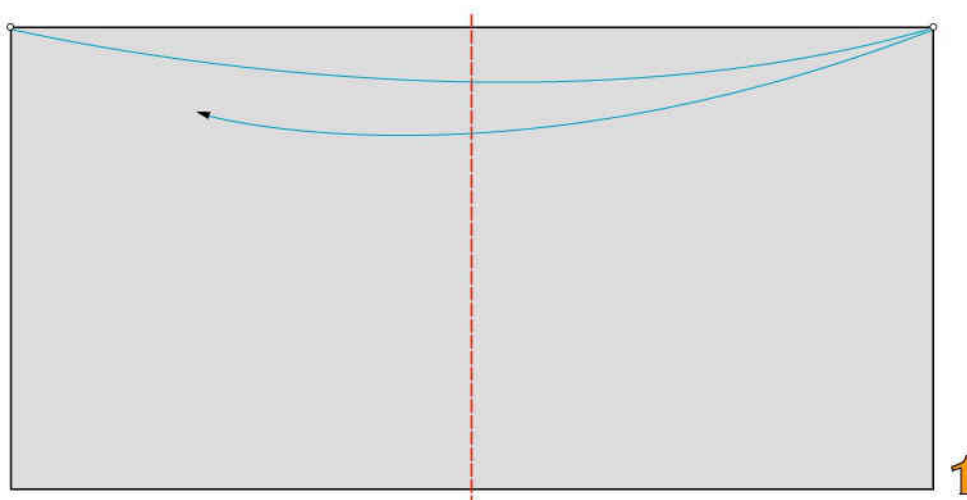

1 piega a valle

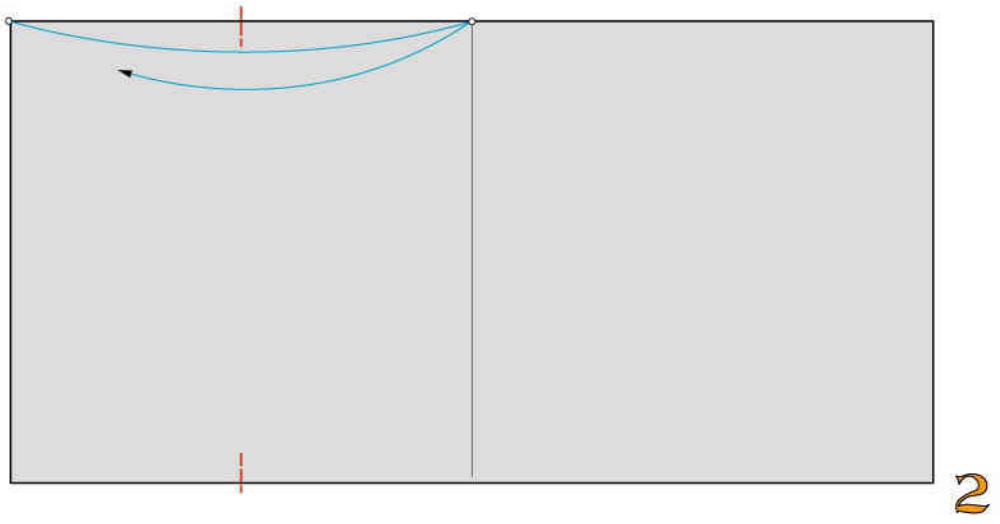

2 piccole pieghe a valle

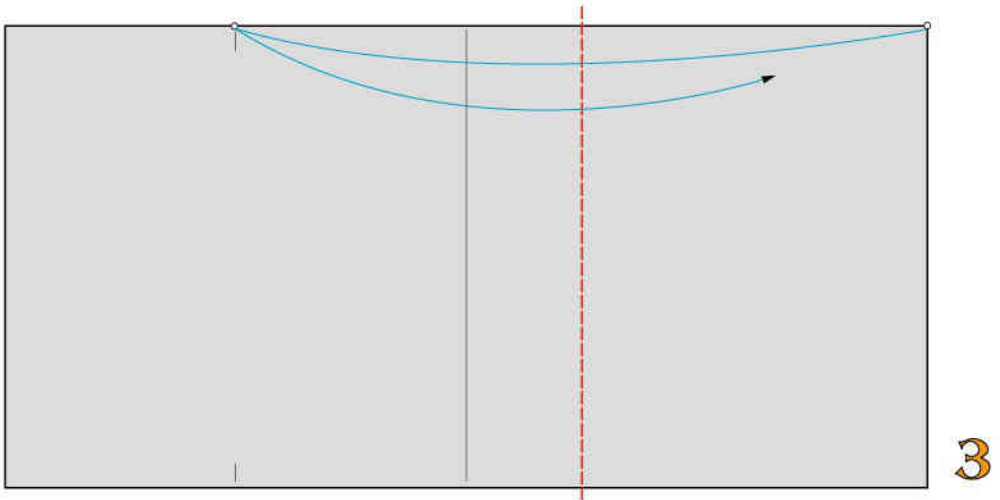

1 piega a valle

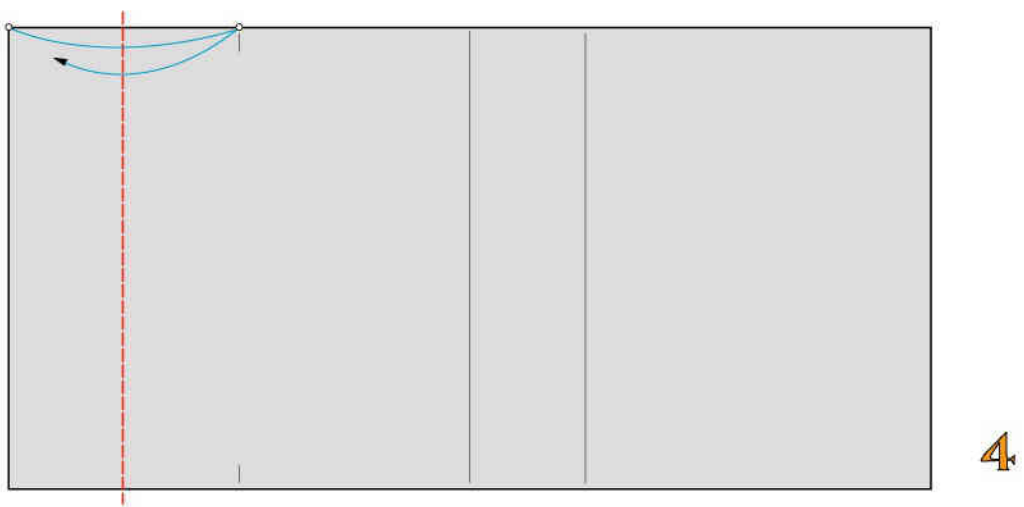

1 piega a valle

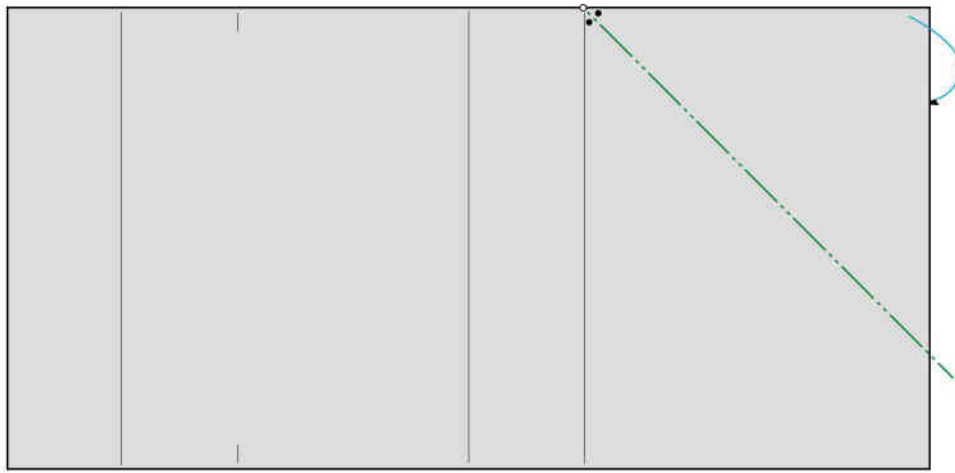

5

1 piega bisettrice a monte

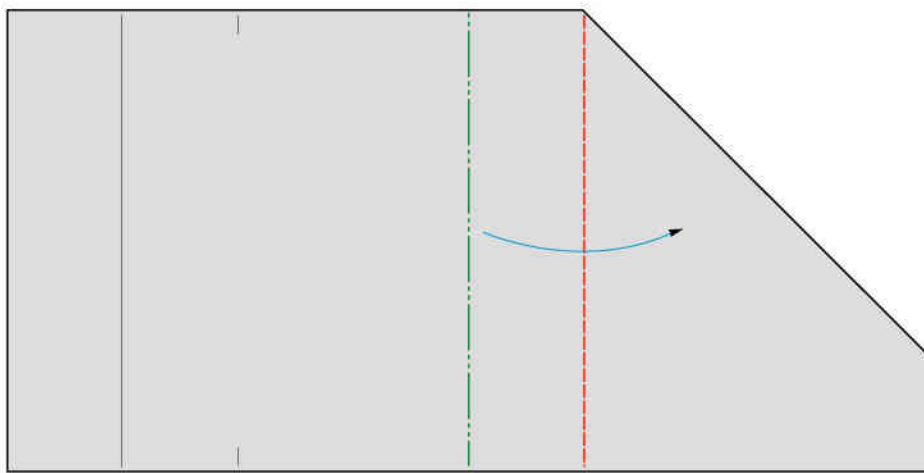

6

Ripiegate a valle e a monte

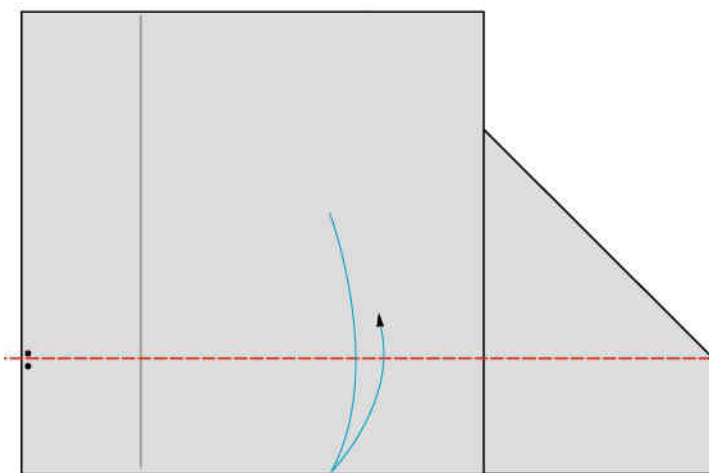

1 piega bisettrice a valle

7

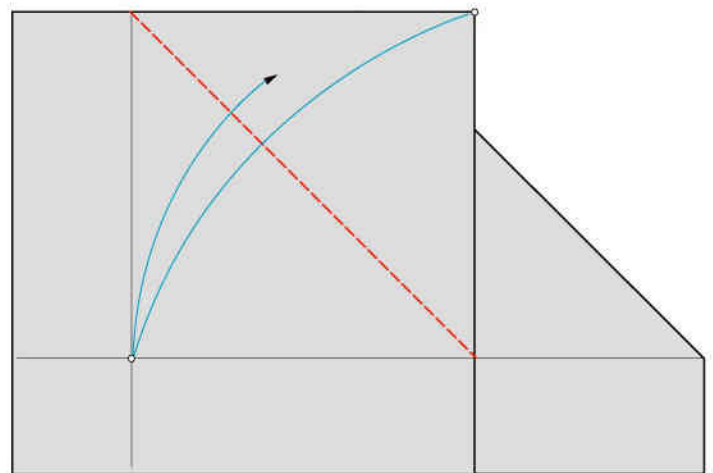

1 piega diagonale a valle

8

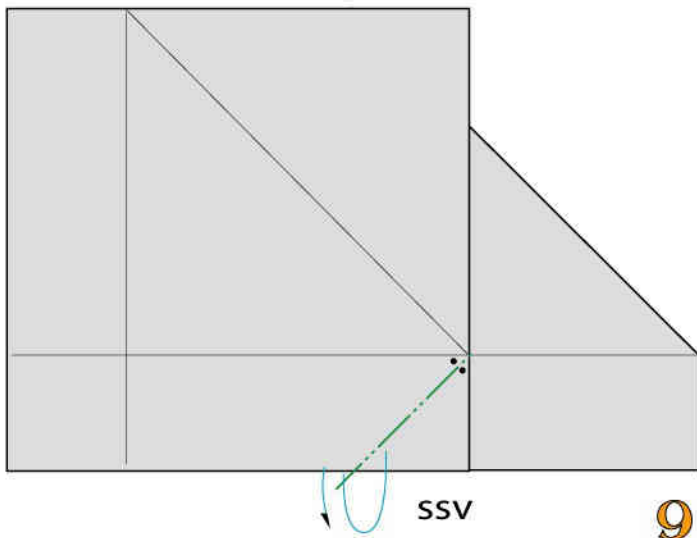

1 piega bisettrice a monte solo sulla superficie in vista **9**

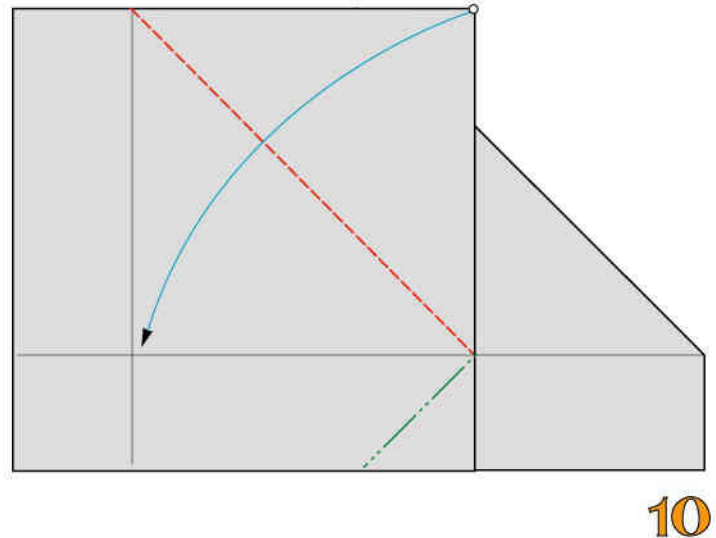

Ripiegate a valle e a monte **10**

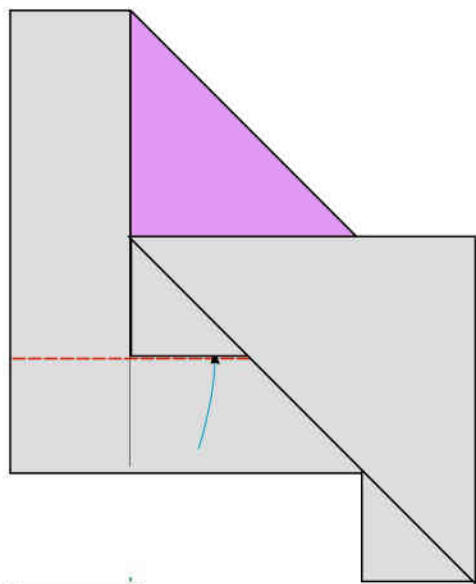

1 piega a valle e intascate

11

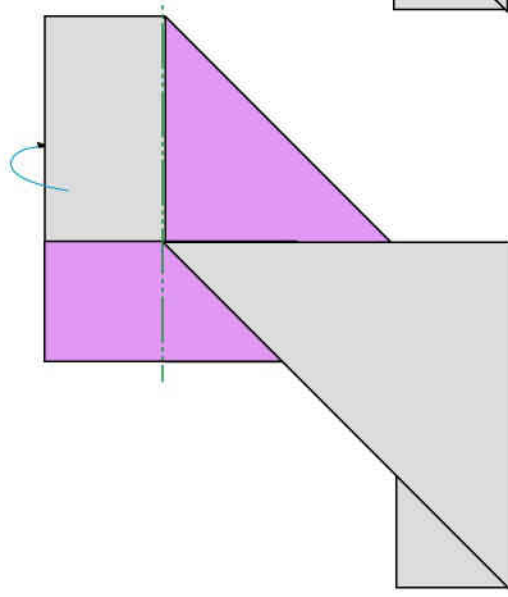

1 piega a monte

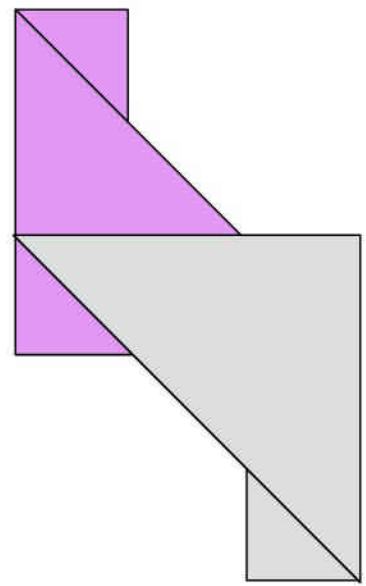

12 Modulo "H" ultimato **13**

UNIONE DEI MODULI

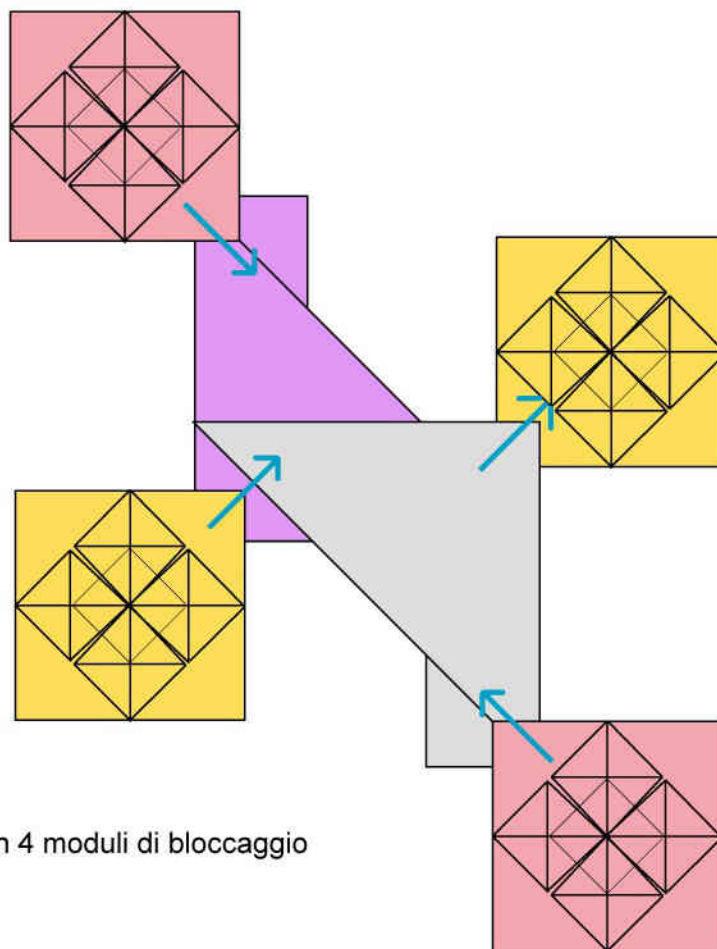

Unite 1 modulo "H" con 4 moduli di bloccaggio

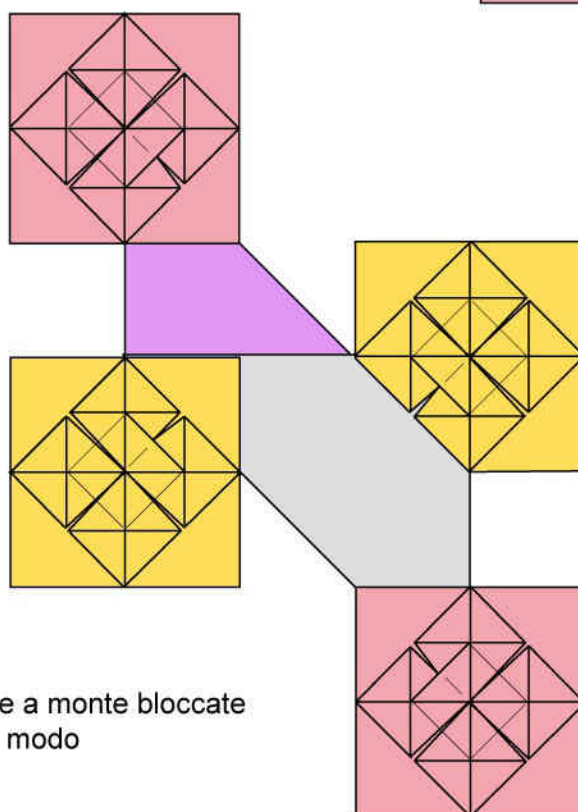

Mediante 4 pieghe a monte bloccate
l'unione nel solito modo

TASSELLAZIONE "I"

MODULARE TRAFORATA

Franco Pavarin 23

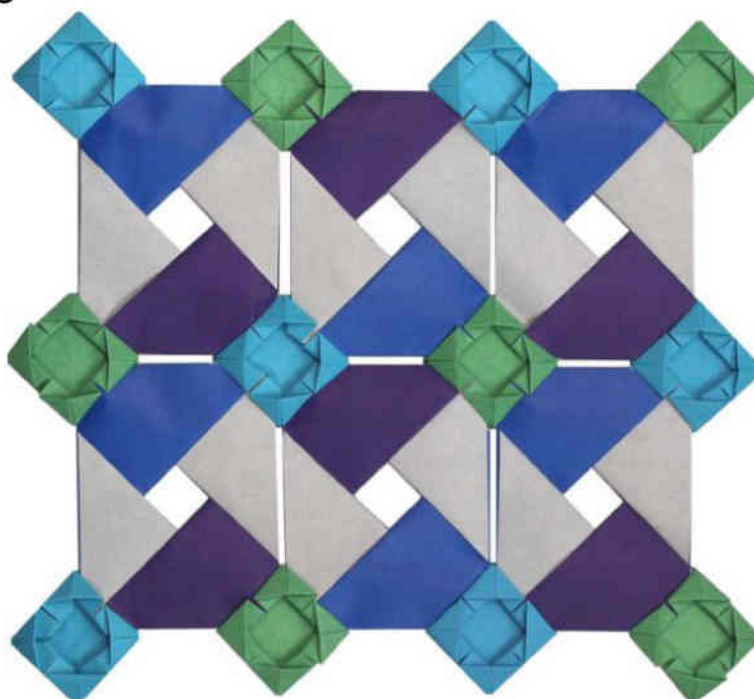

Si lavora con un modulo composto da 2 moduli "I"
Il modulo "I" si costruisce con un foglio rettangolare 2x1 di superficie doppia di quella del modulo di bloccaggio, meglio se bicolore di medio peso.

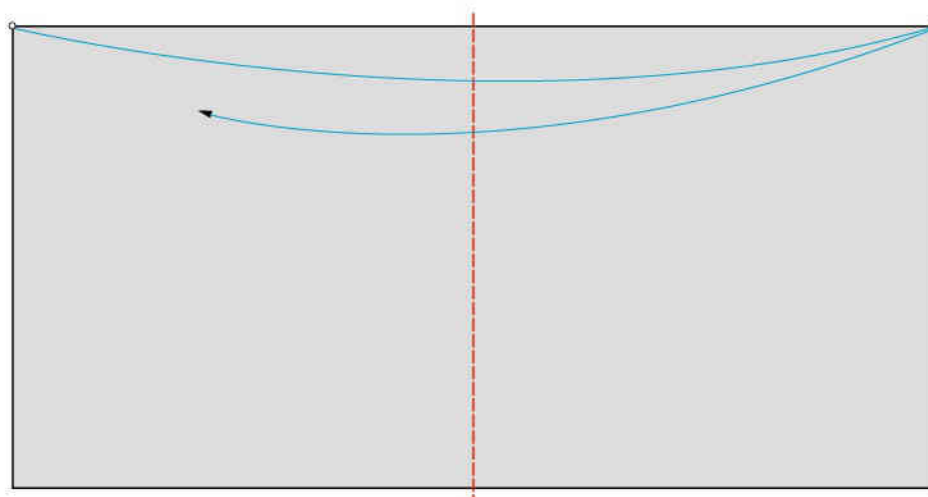

1 piega a valle

1

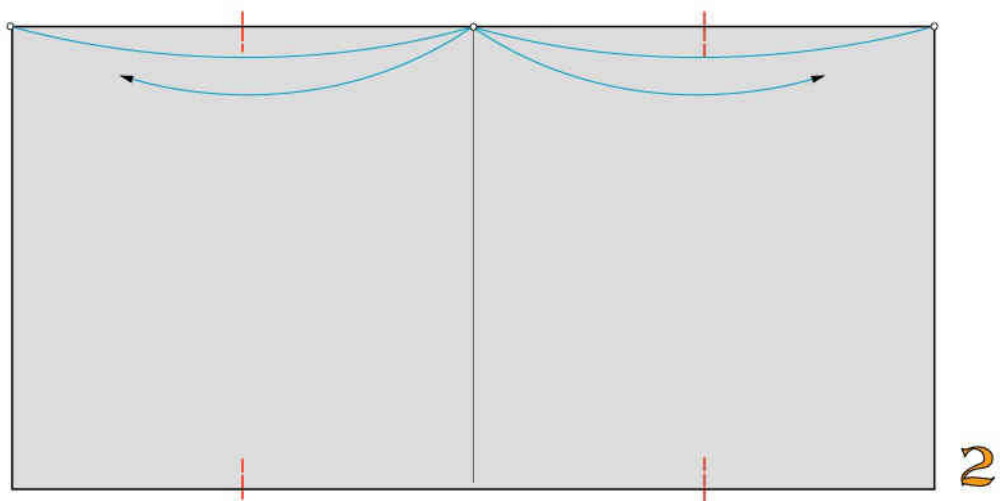

2

4 piccole pieghe a valle

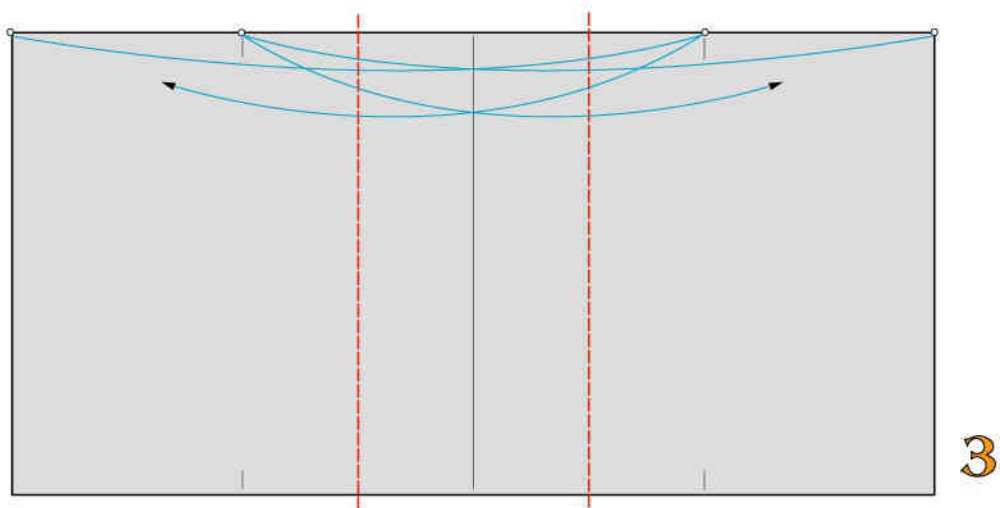

3

2 pieghe a valle

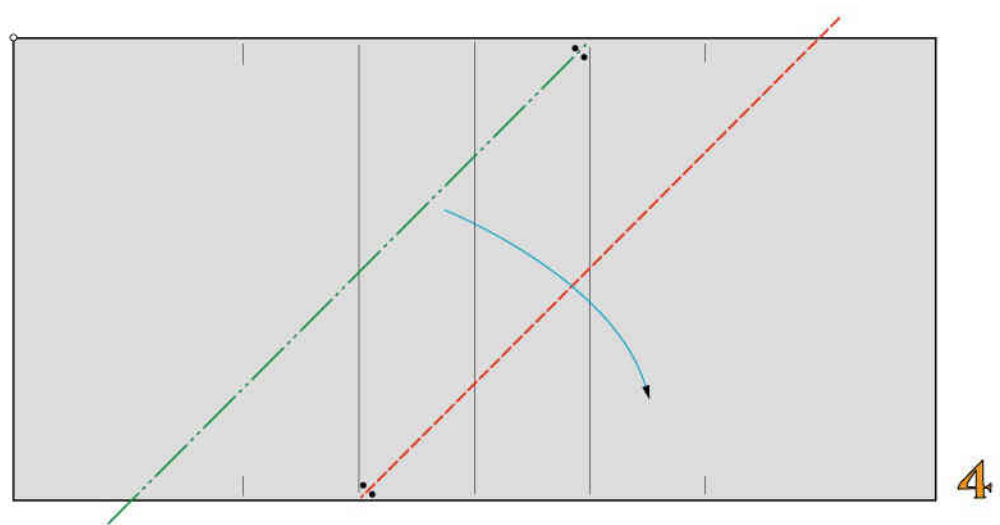

4

1 piega bisettrice a monte e 1 a valle

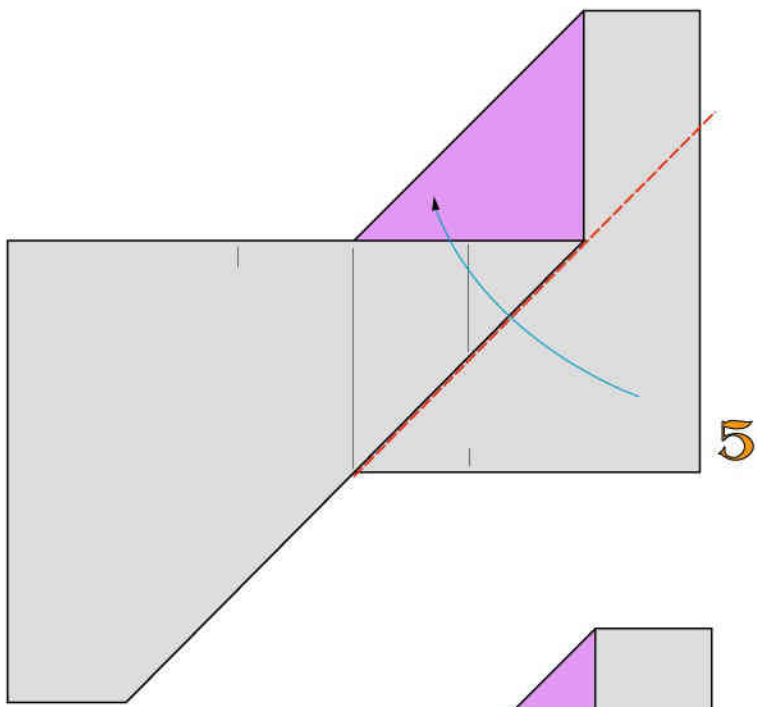

5

1 piega a valle

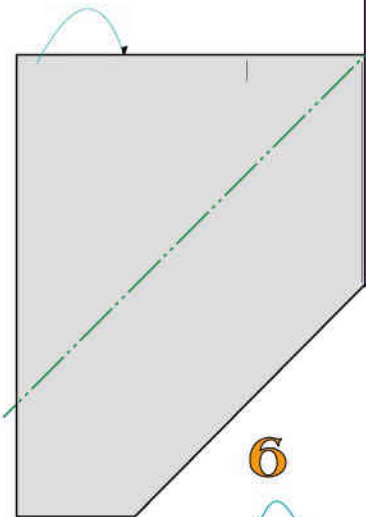

6

1 piega a monte

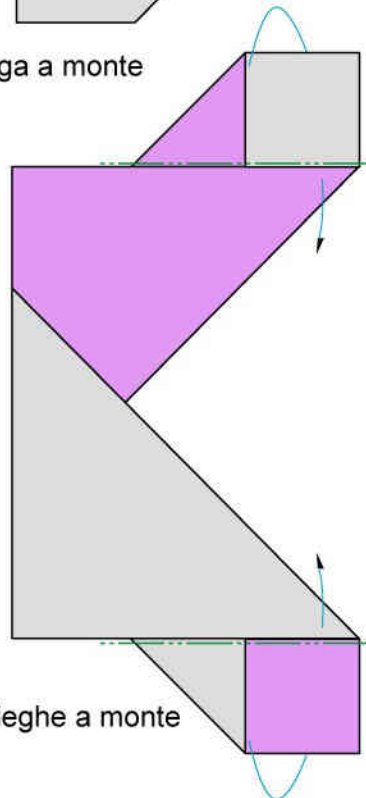

2 pieghe a monte

8

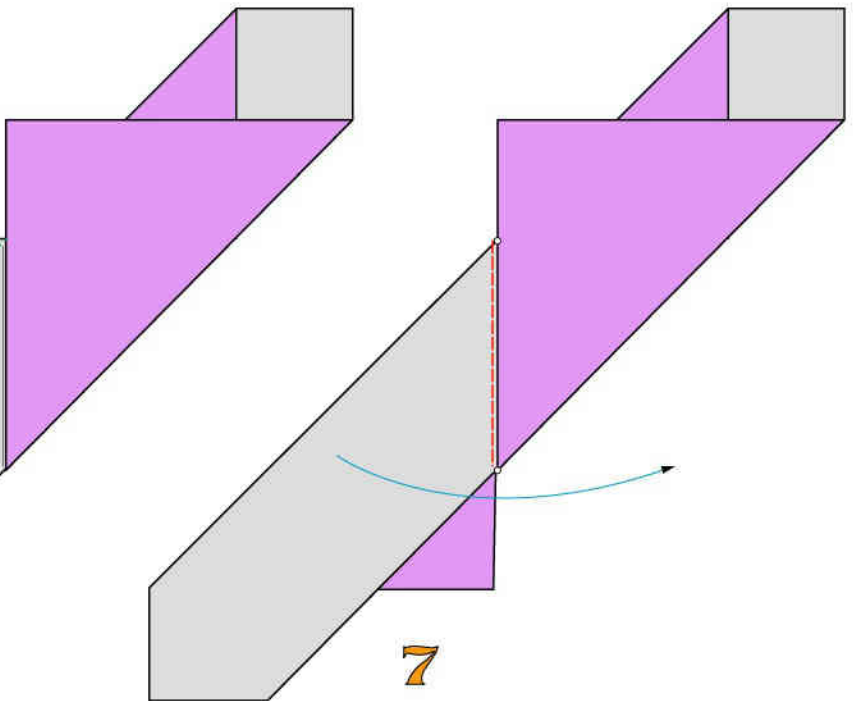

7

1 piega a valle

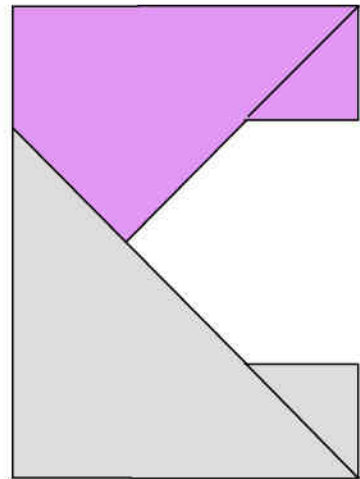

9

Modulo "I" ultimato

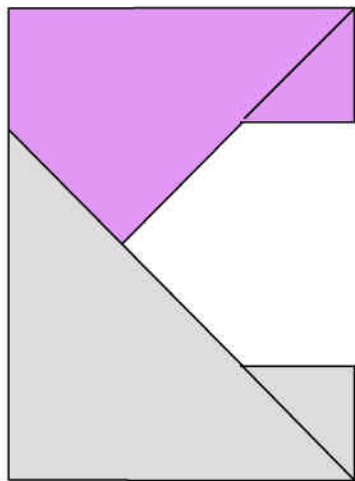

+

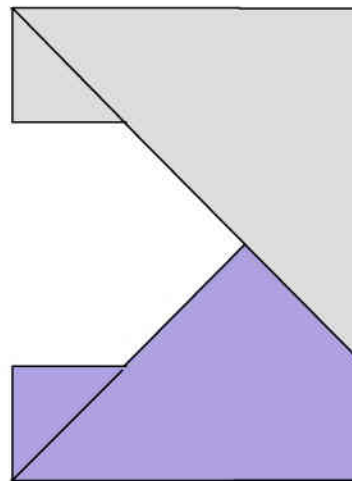

=

1

Unite 2 moduli "1"

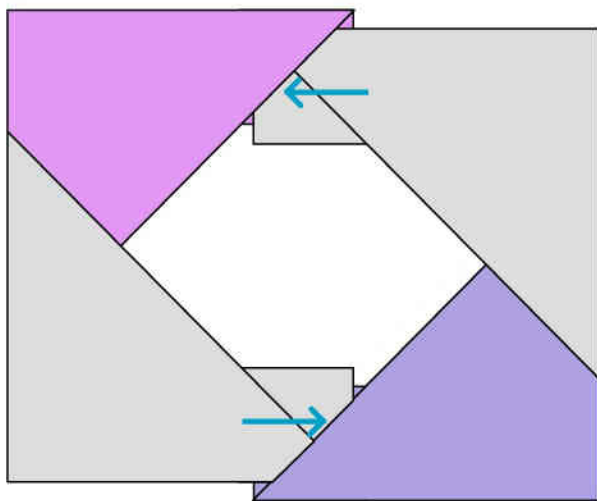

2

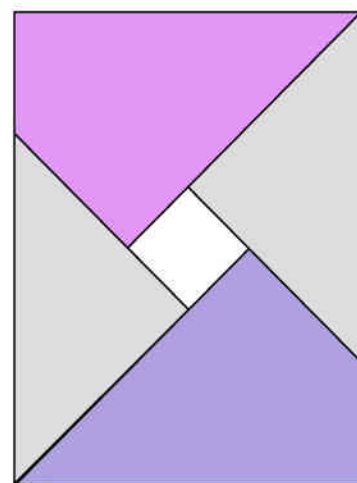

3

Modulo composto formato da 2 moduli "1" ultimato

UNIONE DEI MODULI

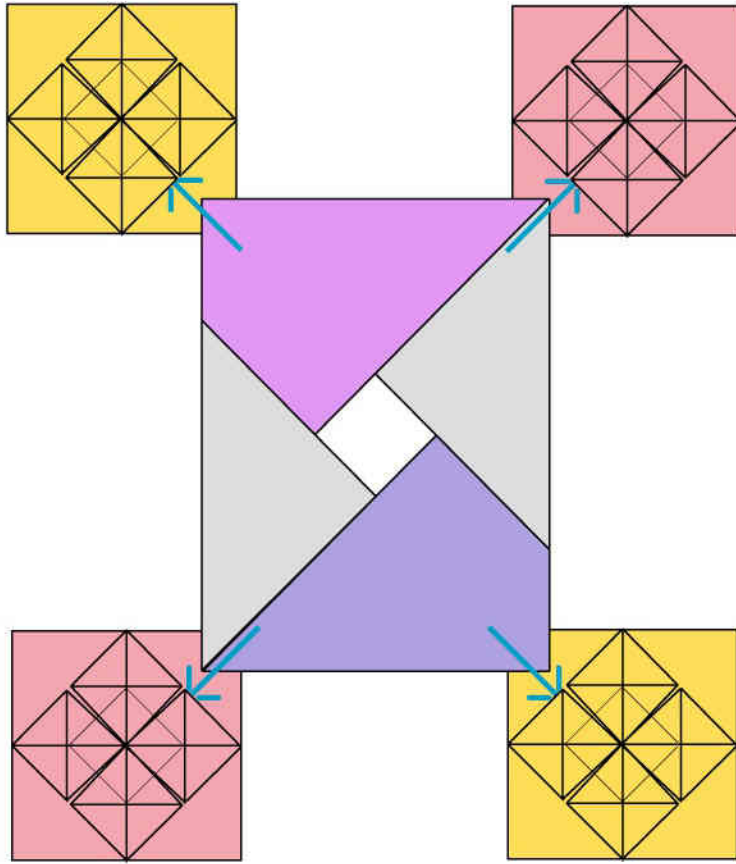

Unite 1 modulo "I" con 4 moduli di bloccaggio

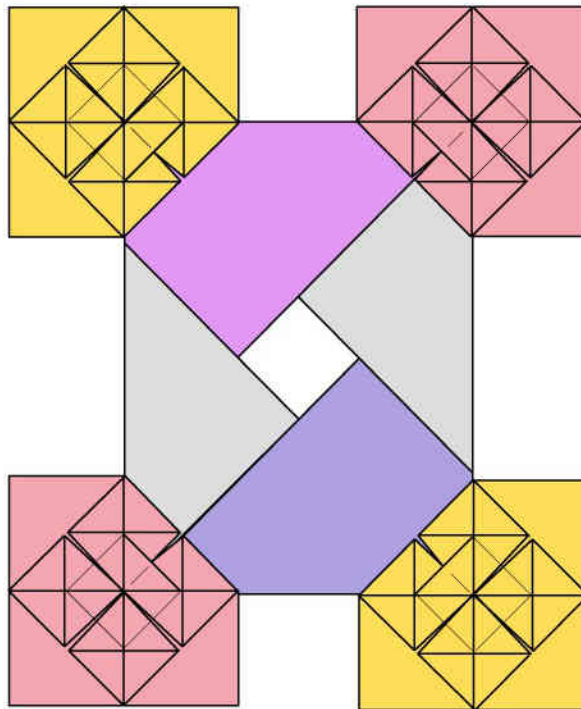

Mediante 4 pieghe a monte bloccate
l'unione nel solito modo

TASSELLAZIONE "11"

MODULARE TRAFORATA

Franco Pavarin 23

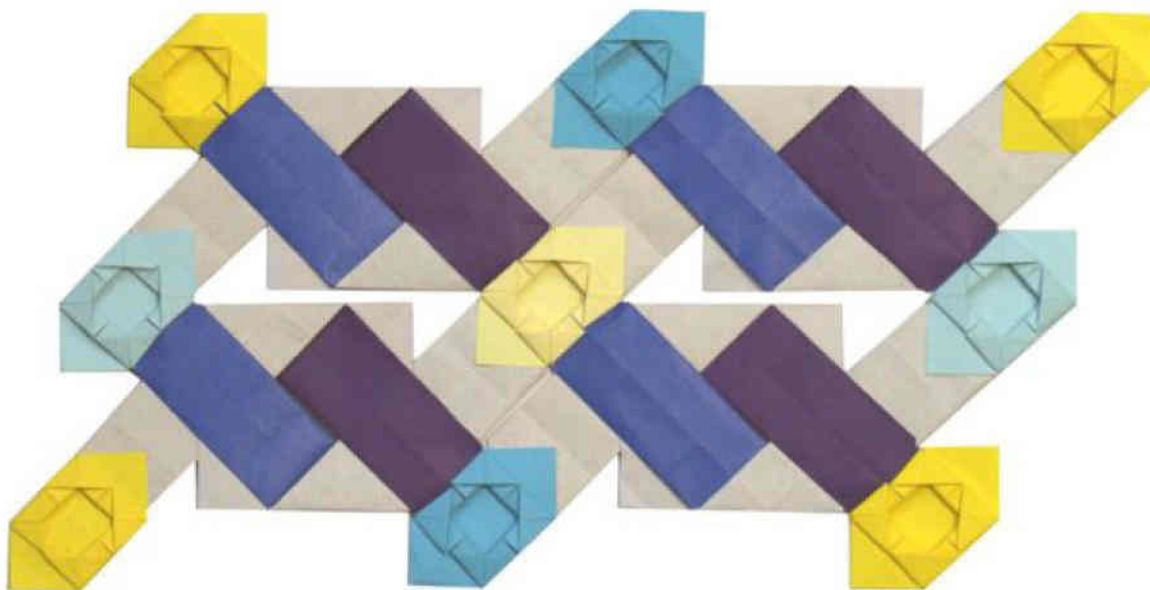

Il modulo "11" si costruisce con un foglio rettangolare 2x1 di superficie doppia di quella del modulo di bloccaggio, meglio se in cartone leggero. Si lavora con un modulo composto da 2 moduli "11"

Partite dalla figura n. 6 del modulo "1"

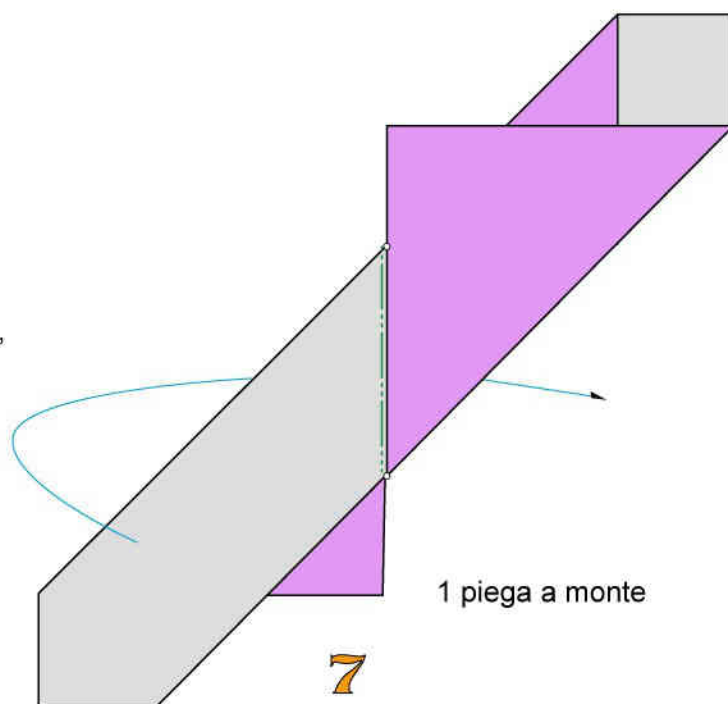

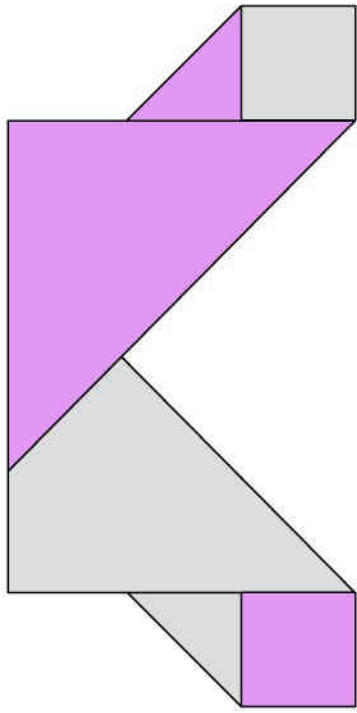

+

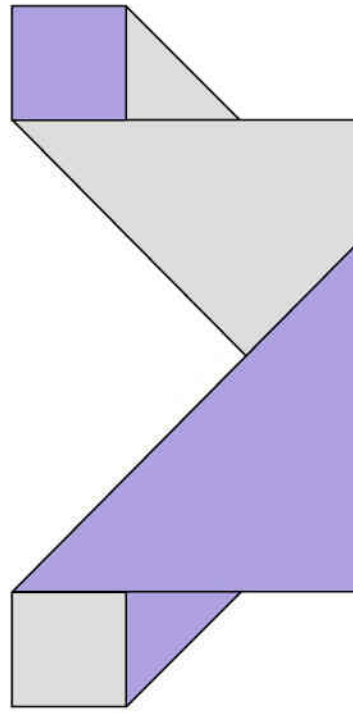

=

Unite 2 moduli "I1"

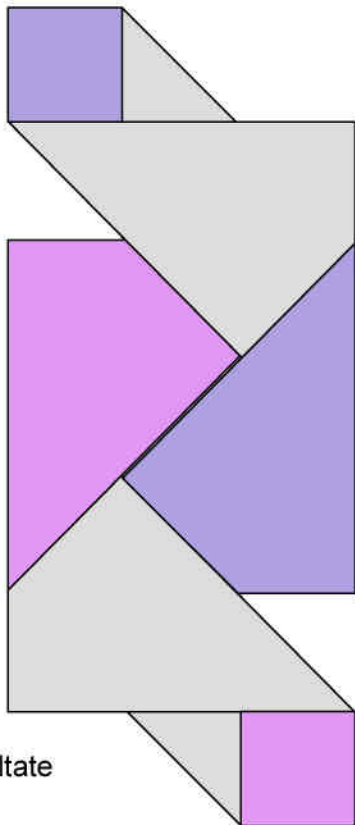

Ribaltate

2

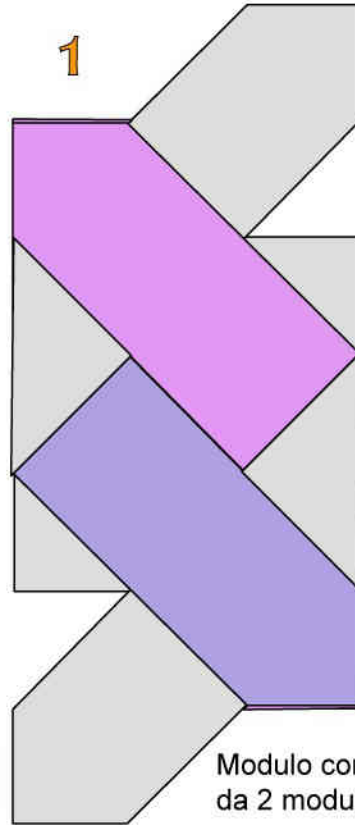

3

Modulo composto formato da 2 moduli "I1" ultimato

UNIONE DEI MODULI

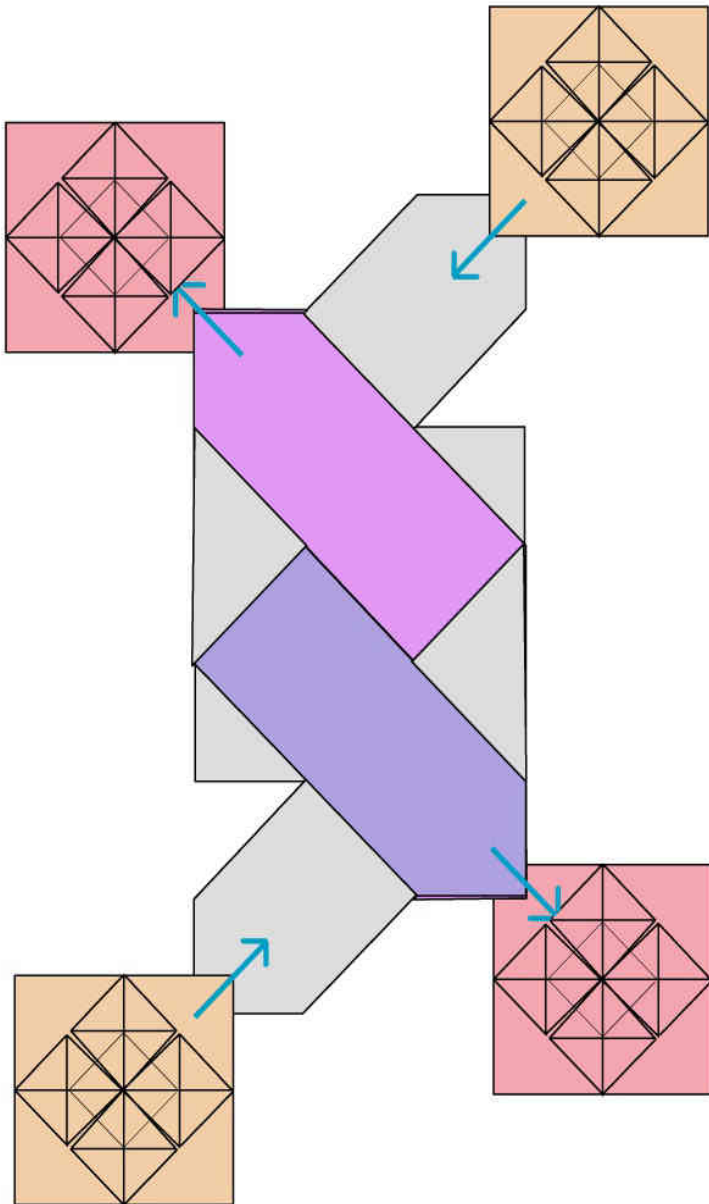

Unite 1 modulo "I1" con 4 moduli di bloccaggio

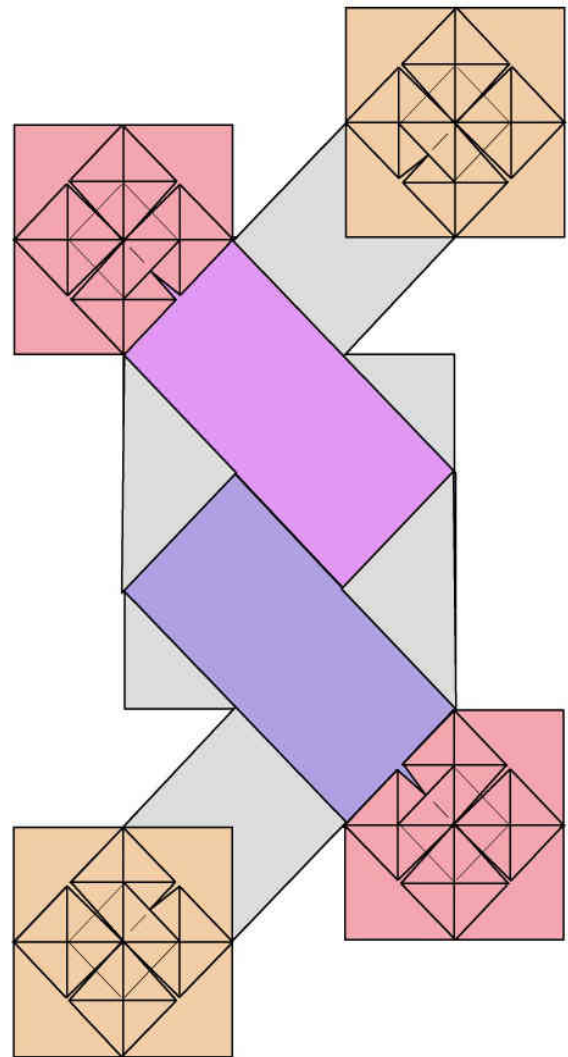

Mediante 4 pieghe a monte bloccate
l'unione nel solito modo

TASSELLAZIONE "12"

MODULARE COMPATTA

Franco Pavarin 23

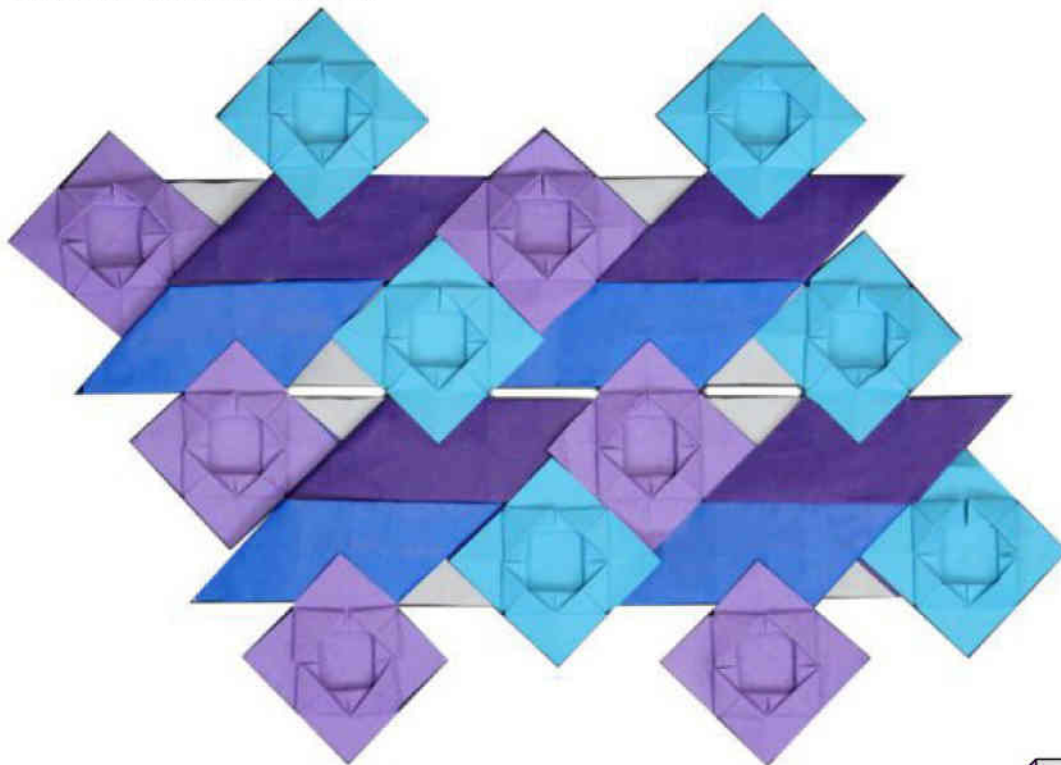

Si lavora con un modulo composto da 2 moduli "12"
Il modulo "12" si costruisce con un foglio rettangolare 2x1 di superficie doppia di quella del modulo di bloccaggio, meglio se bicolore di medio peso.

Partite dalla figura n. 5 del modulo "1"

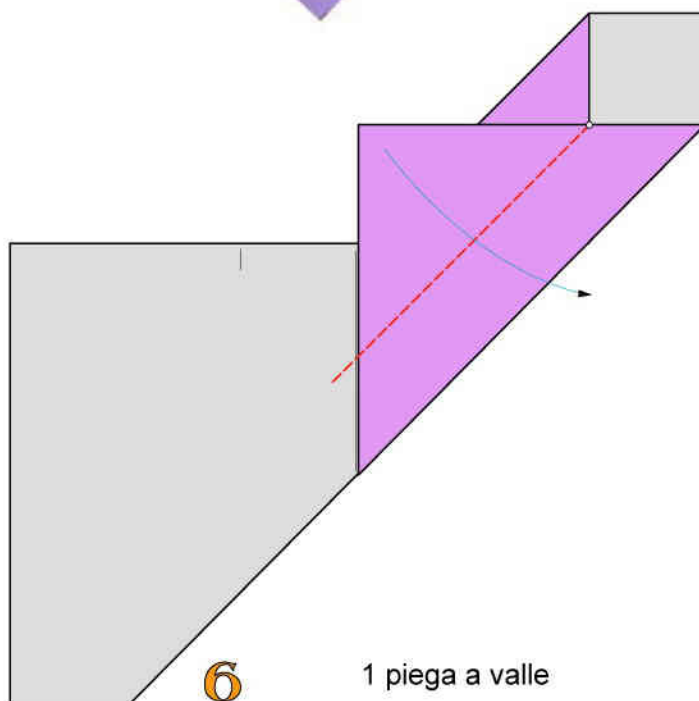

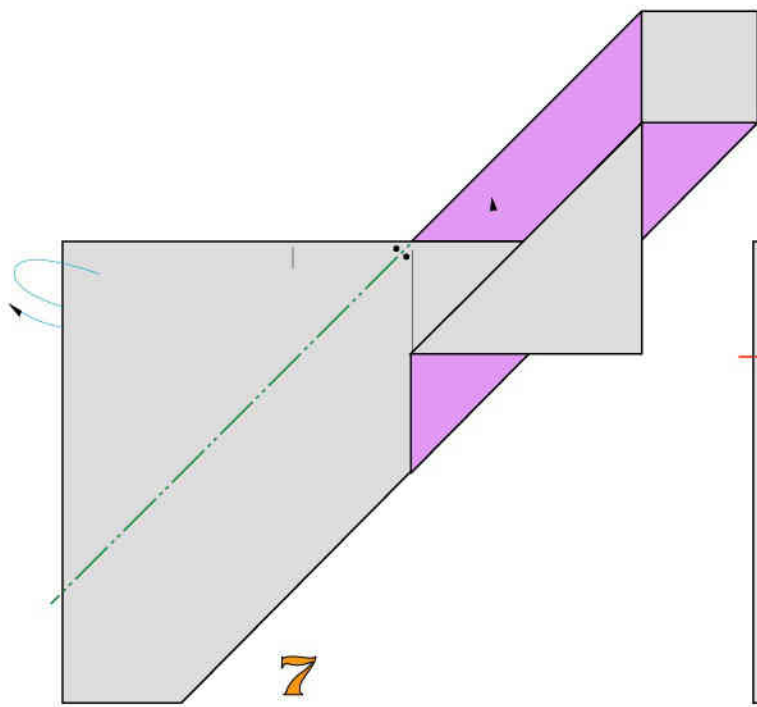

1 piega bisettrice a monte

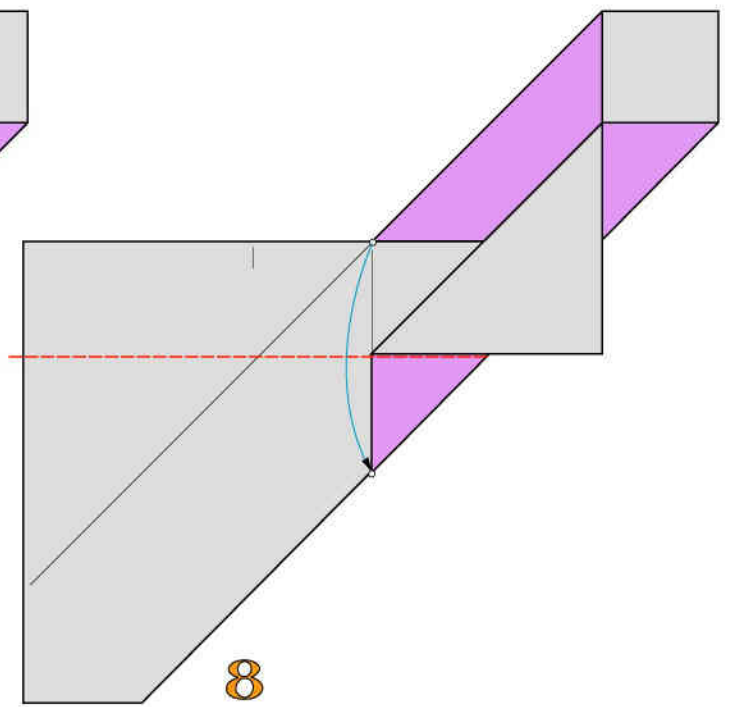

1 piega a valle

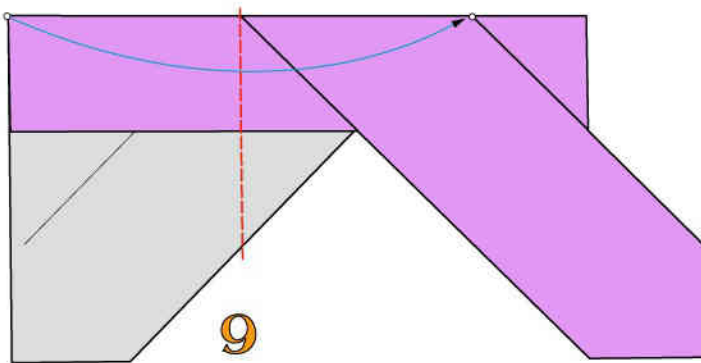

1 piega a valle

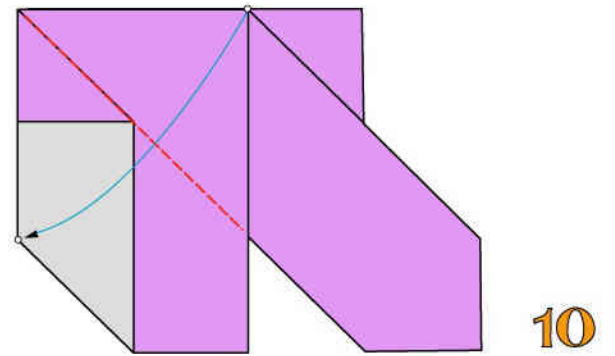

1 piega a valle

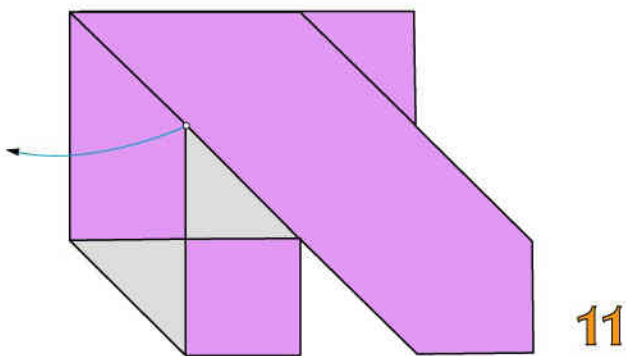

Aprite

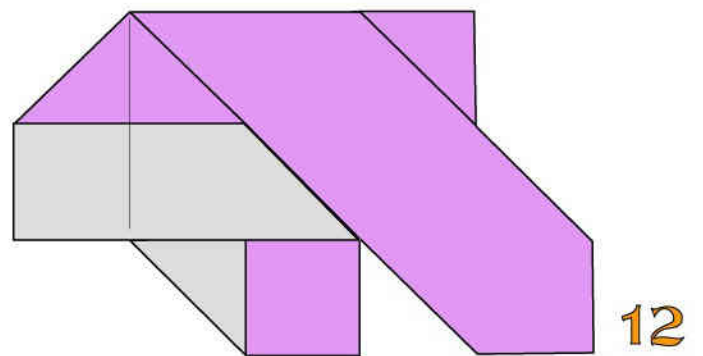

Modulo I2 ultimato

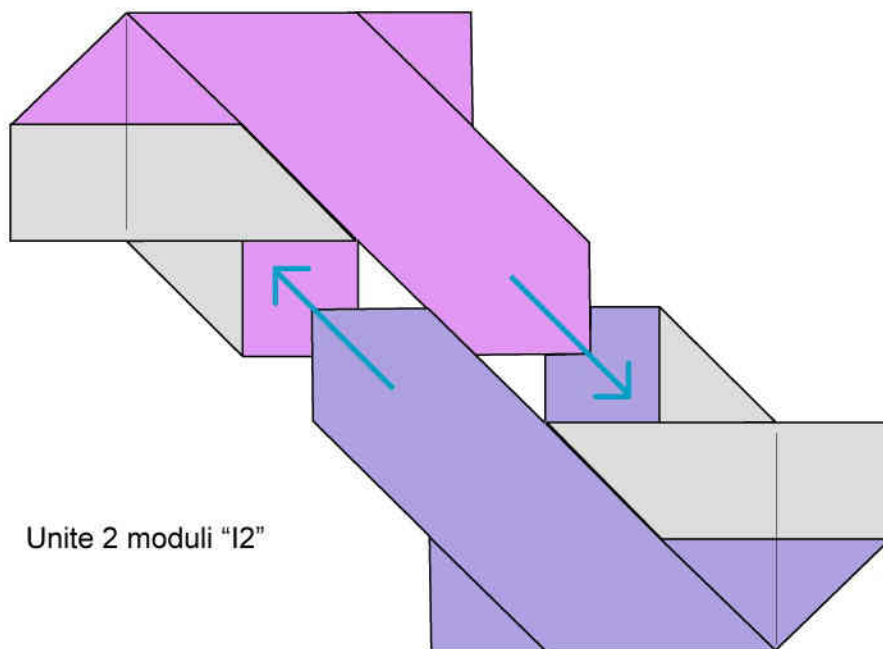

Unite 2 moduli "I2"

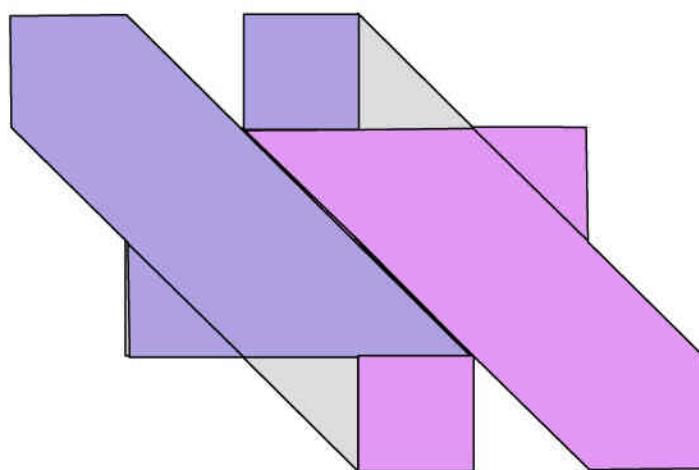

Modulo composto formato
da 2 moduli "I2" ultimato

UNIONE DEI MODULI

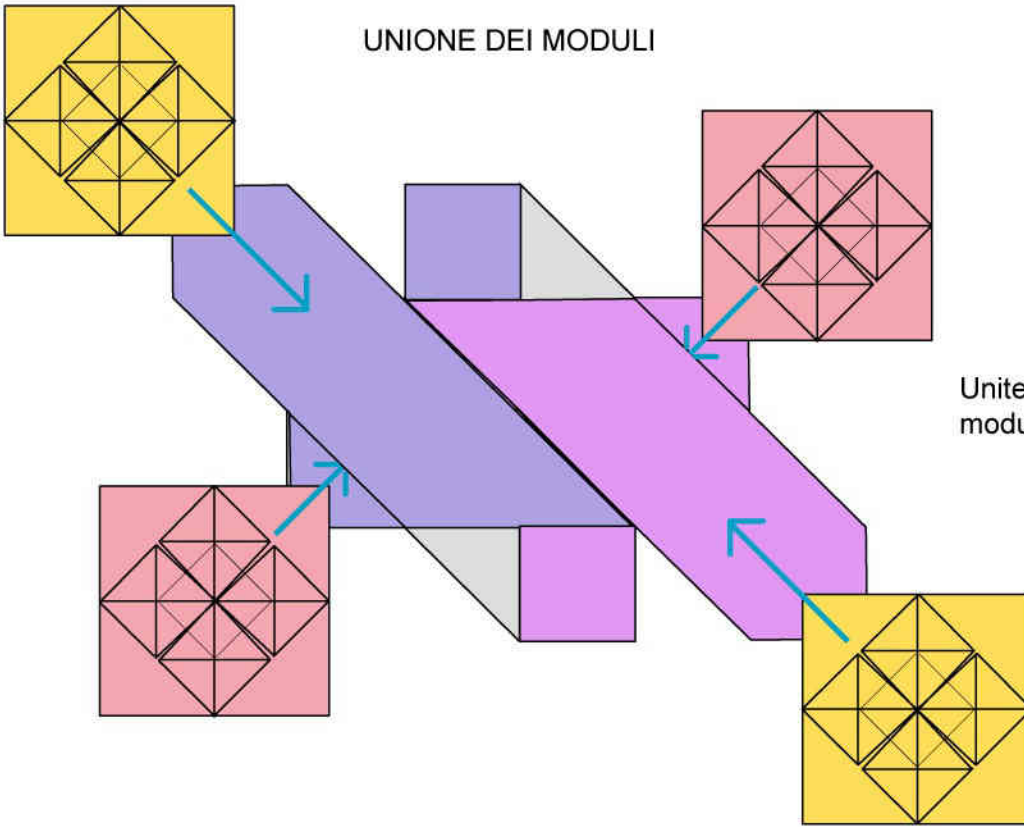

Unite 1 modulo "1" con 4 moduli di bloccaggio

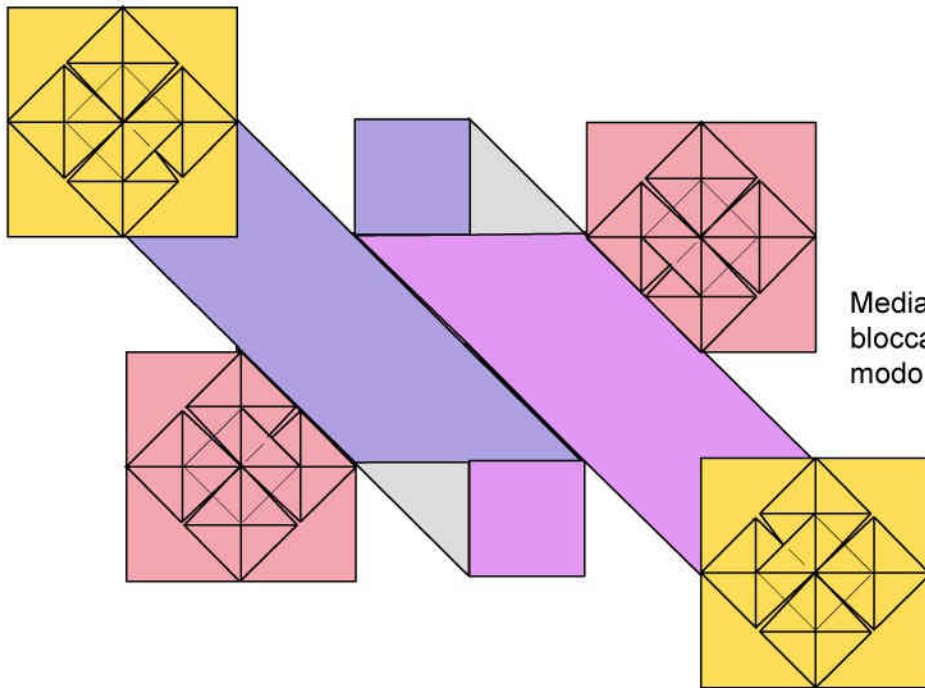

Mediante 4 pieghe a monte bloccate l'unione nel solito modo

TASSELLAZIONE "L"

MODULARE TRAFORATA

Franco Pavarin 23

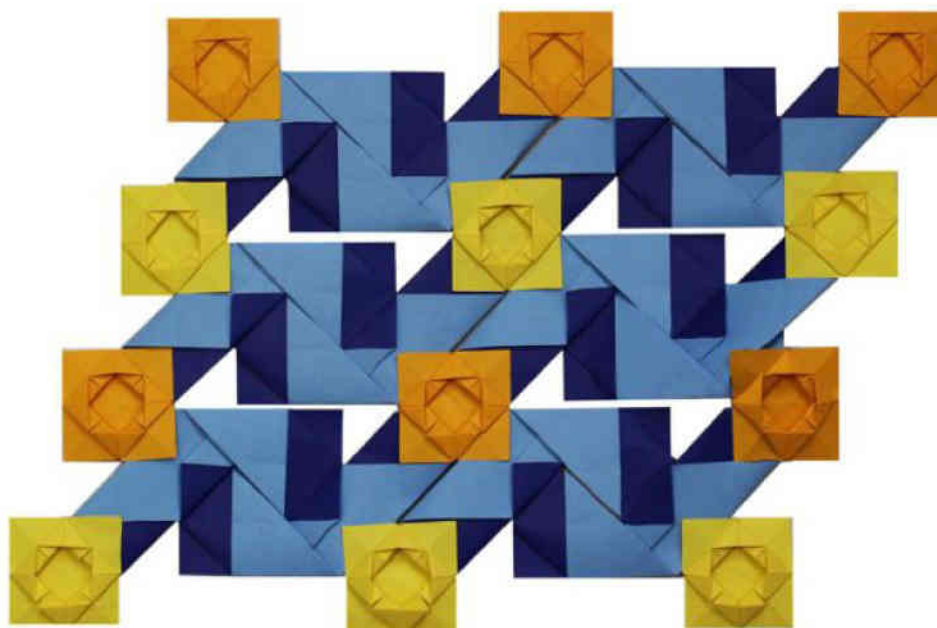

Si lavora con un modulo
composto da 2 moduli "L"
Il modulo "L" si costruisce con
un foglio rettangolare 2x1 di
superficie doppia di quella del
modulo di bloccaggio, meglio
se bicolore di medio peso.

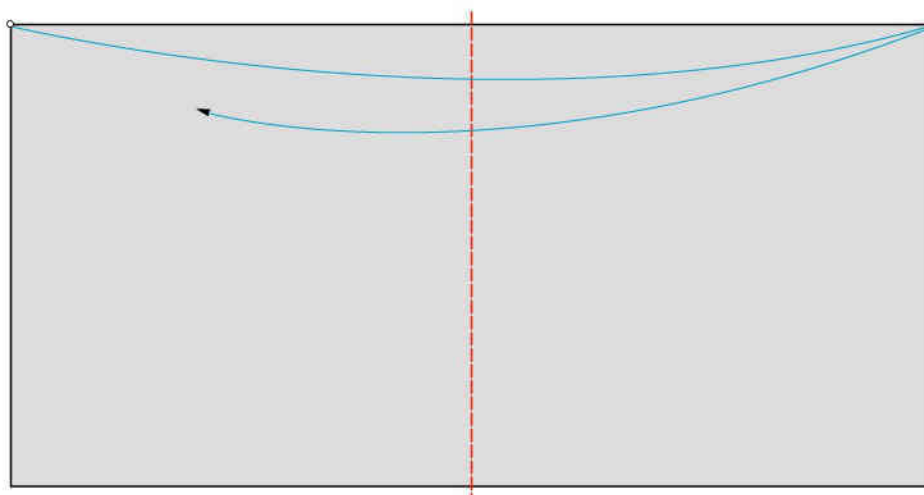

1 piega a valle

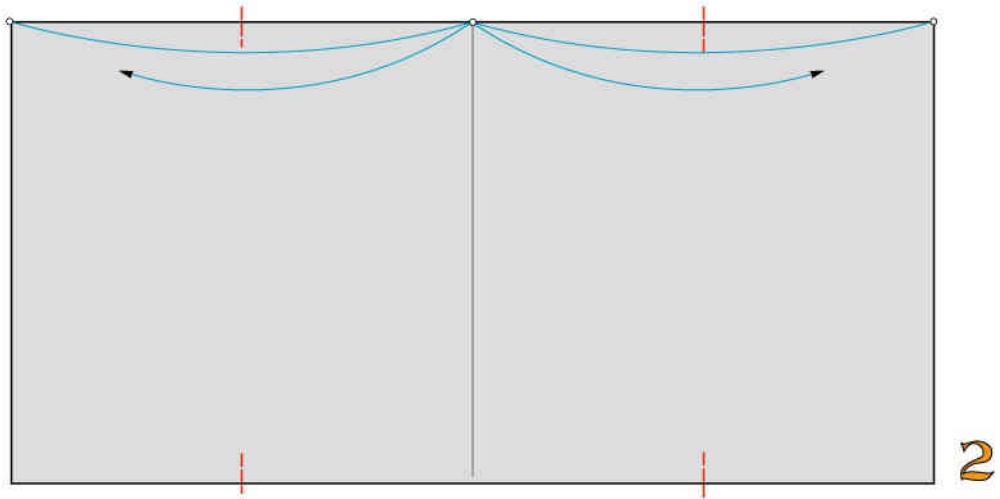

4 piccole pieghe a valle

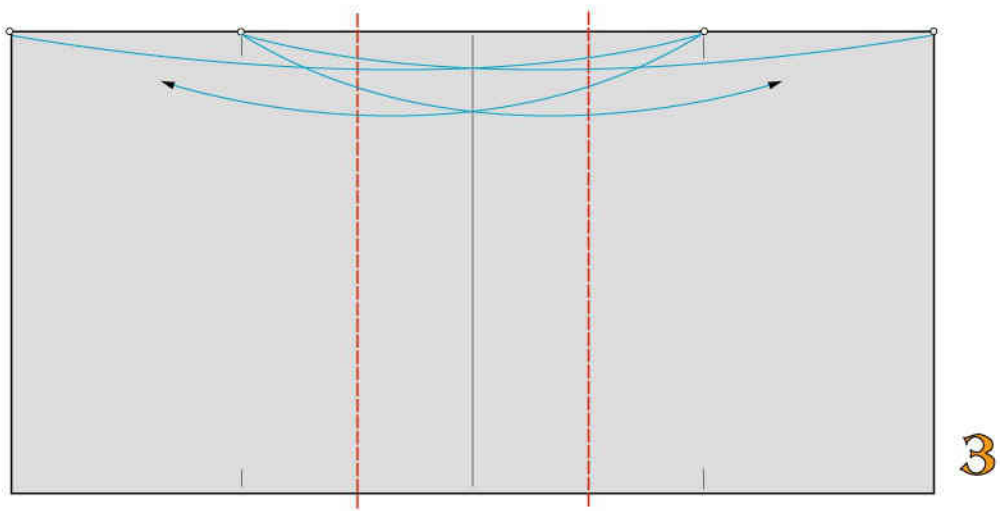

2 pieghe a valle

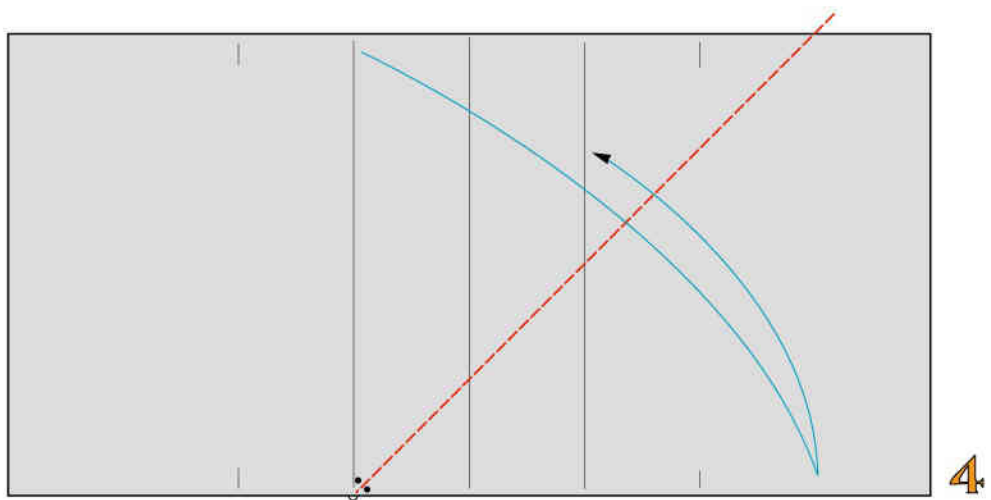

1 piega bisettrice a valle

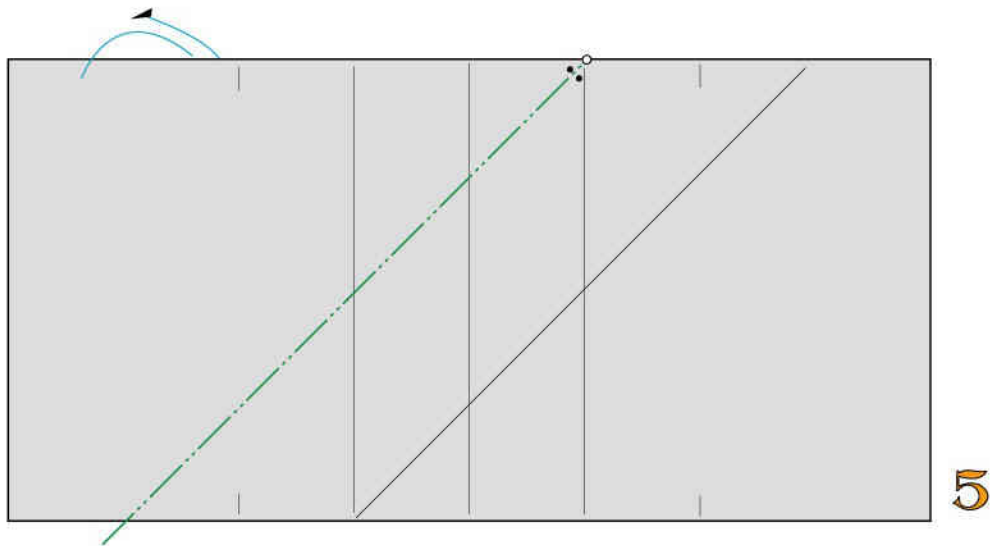

5

1 piega bisettrice a monte

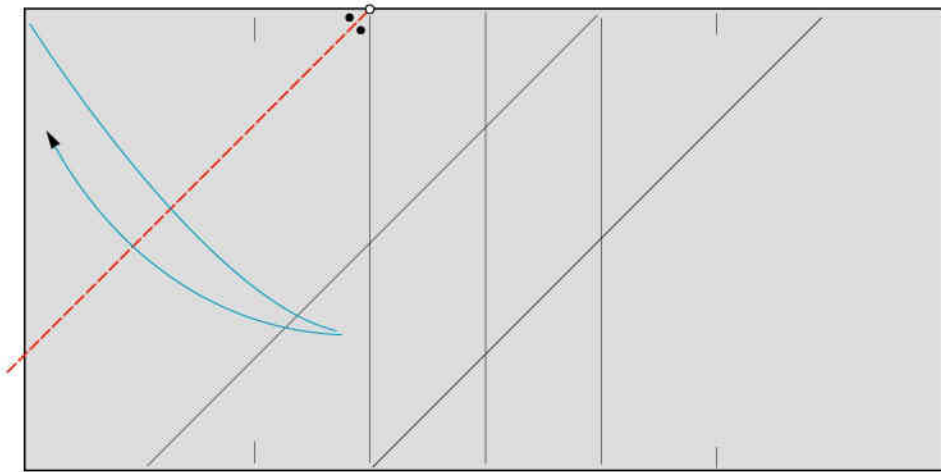

6

1 piega bisettrice a valle

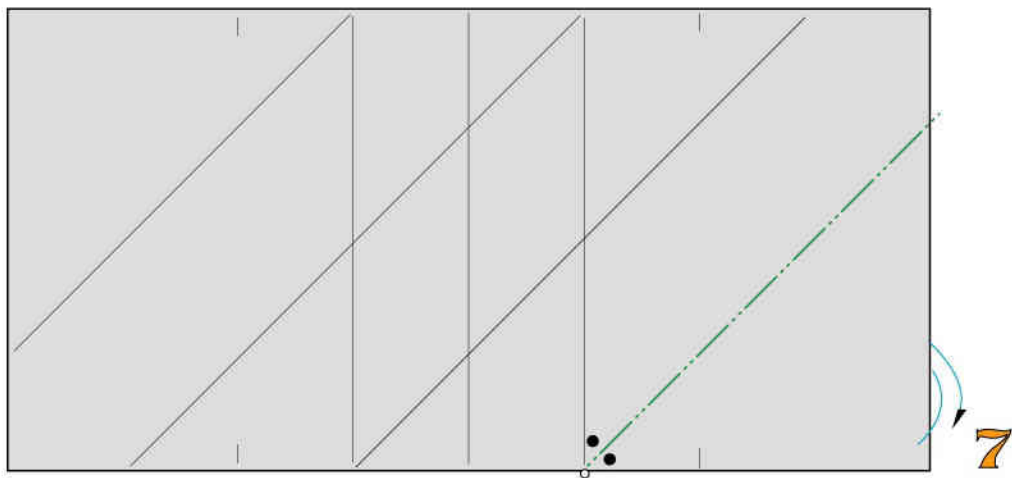

7

1 piega bisettrice a monte

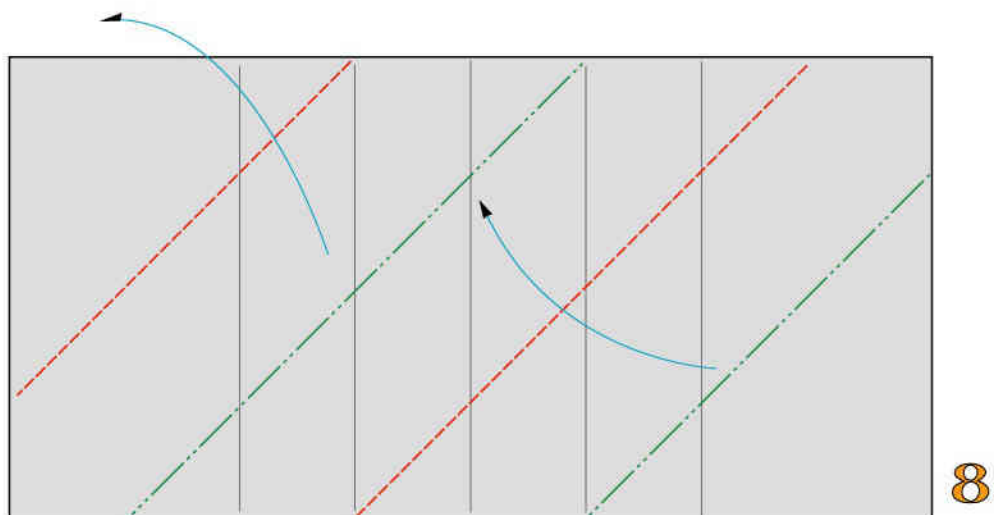

Ripiegate a valle e a monte

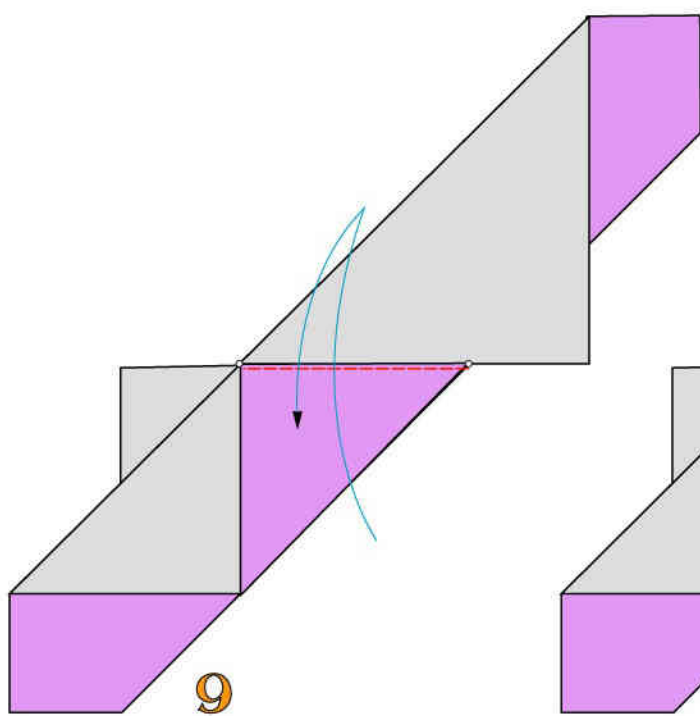

Ripiegate a valle

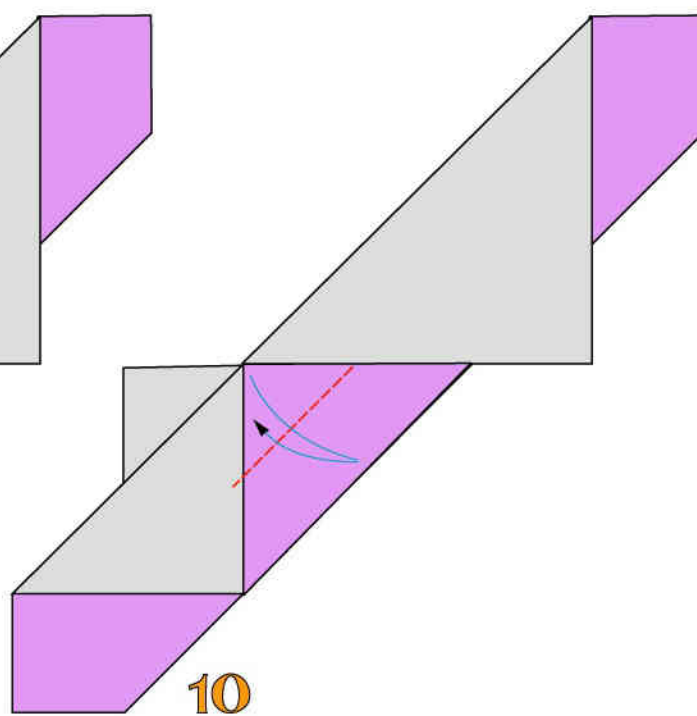

1 piega a valle solo sulla superficie in vista

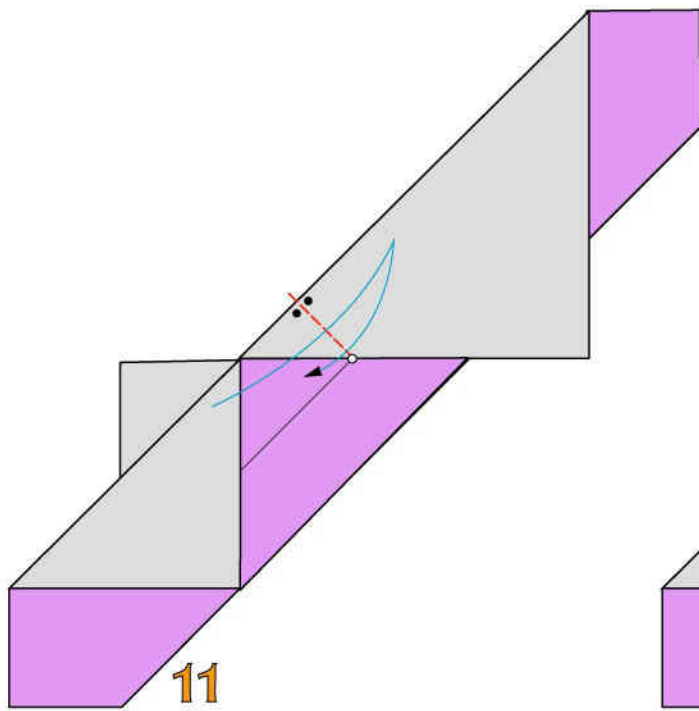

11

1 piega a valle solo sulla superficie in vista

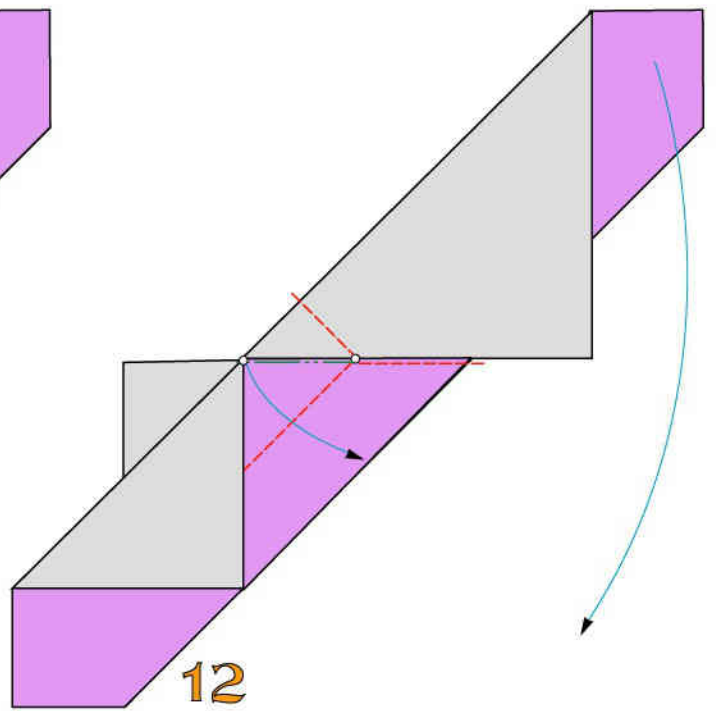

12

Ripiegate a valle e a monte

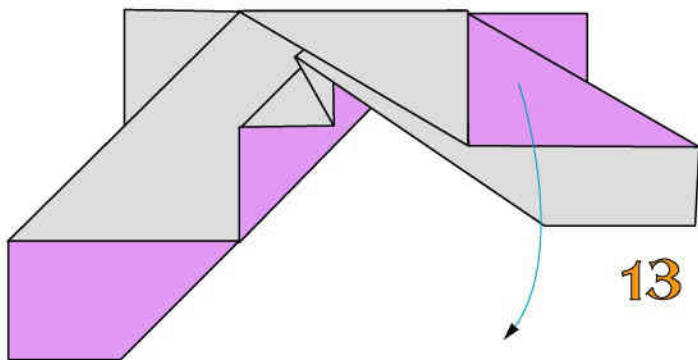

13

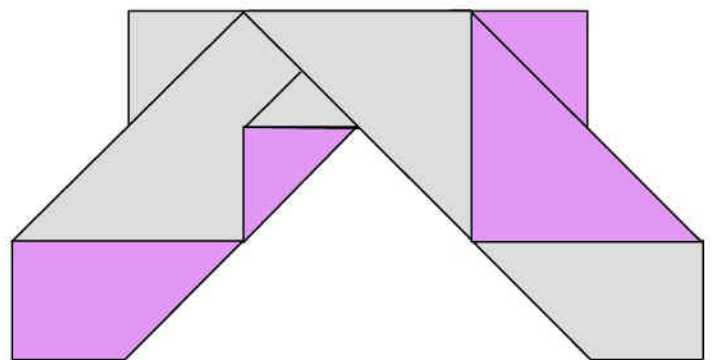

14

Modulo "L" ultimato

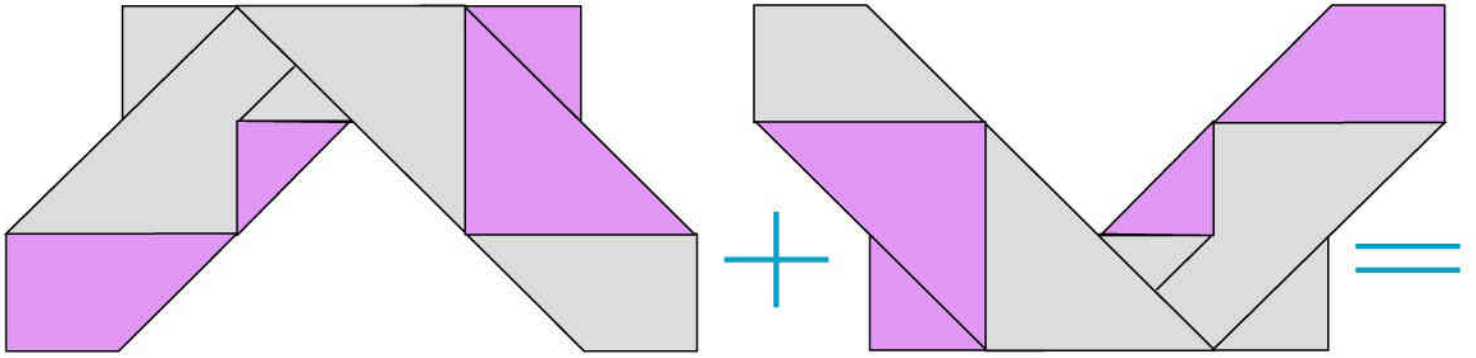

Unite 2 moduli "L"

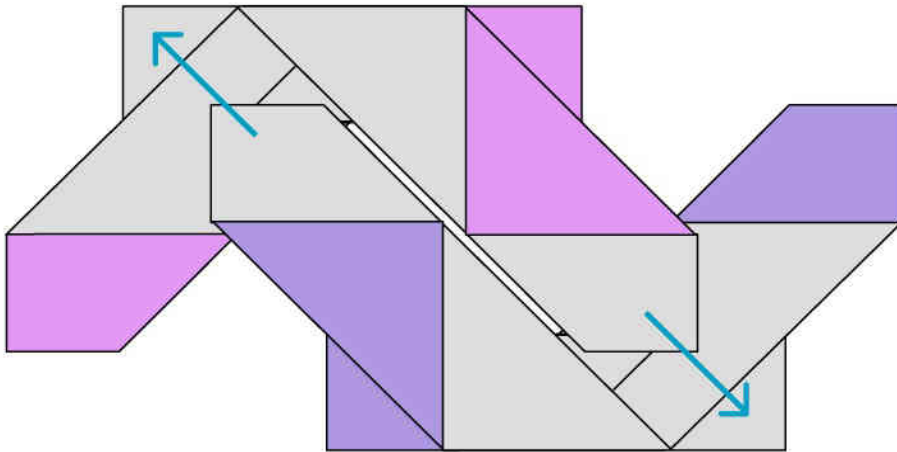

UNIONE DEI MODULI

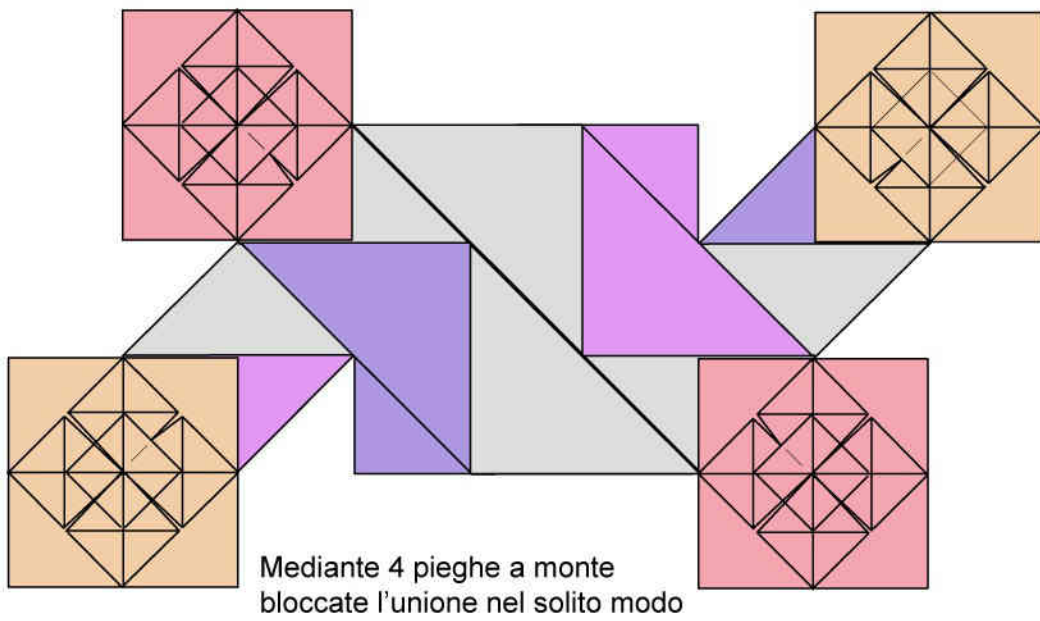
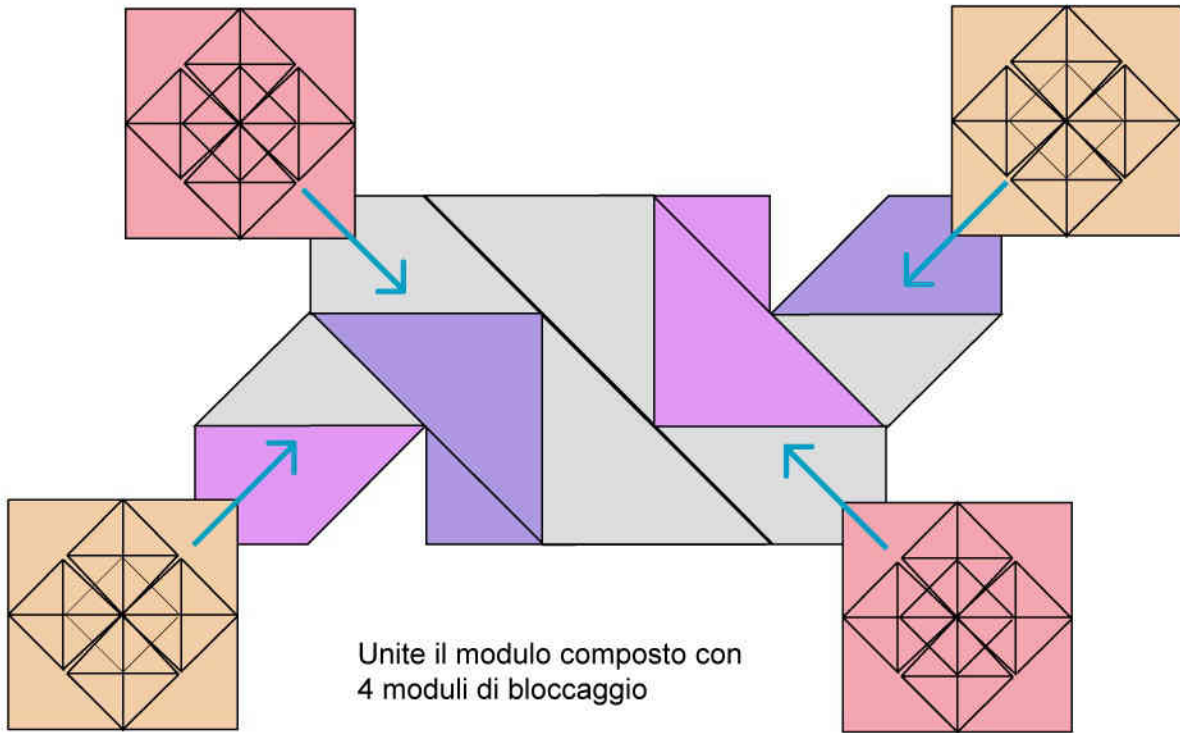

TASSELLAZIONE "M"

MODULARE COMPATTA CILINDRICA

Franco Pavarin 23

Si lavora unendo 2 tipi di modulo differenti con moduli di bloccaggio.

Il modulo "M1" si costruisce con un foglio rettangolare 2x1 di superficie doppia di quella del modulo di bloccaggio; carta monocolore pesante.

Il modulo "M2" si costruisce con un foglio quadrato delle stesse dimensione di quelli adoperati per i moduli di bloccaggio, carta monocolore di medio peso



MODULO "M1"

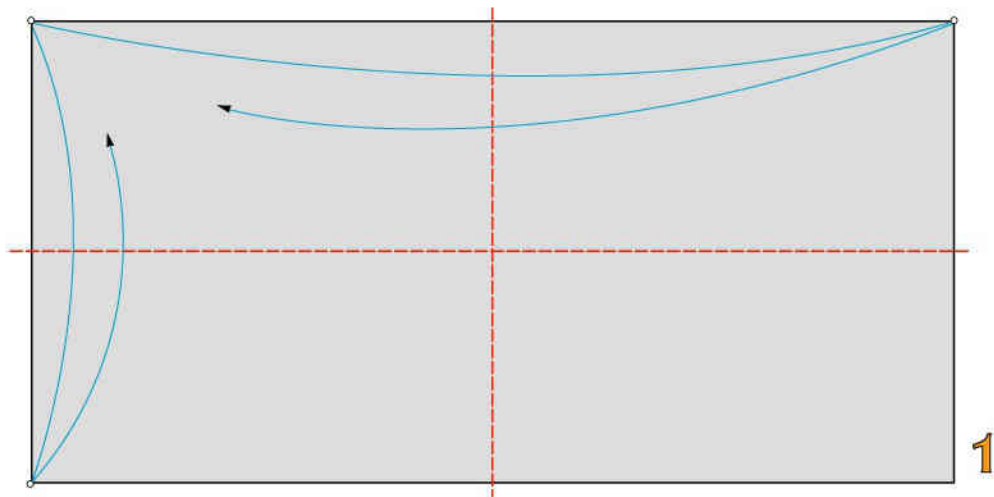

2 pieghe a valle

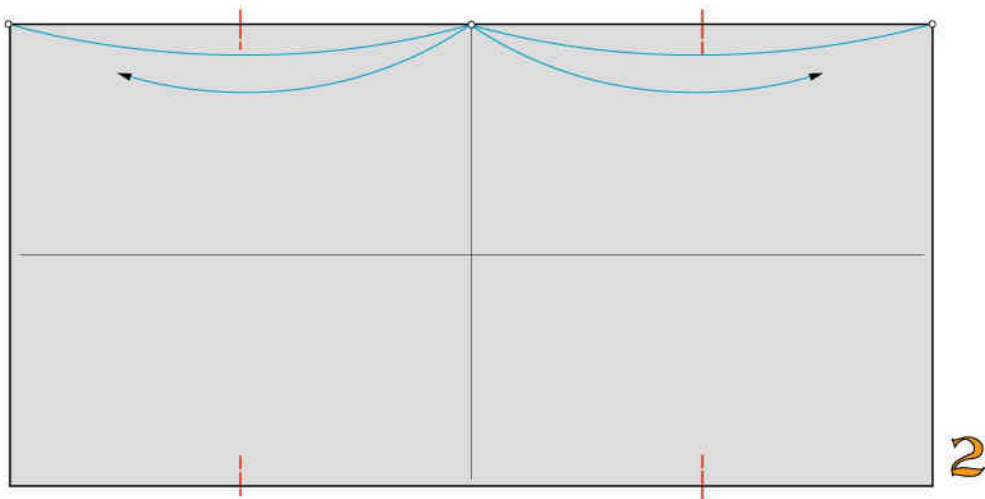

4 piccole pieghe a valle

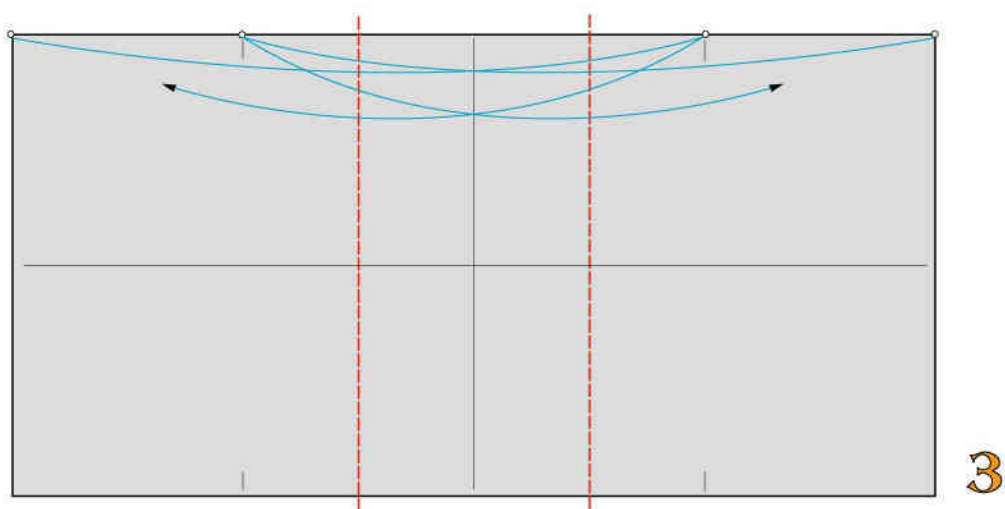

2 pieghe a valle

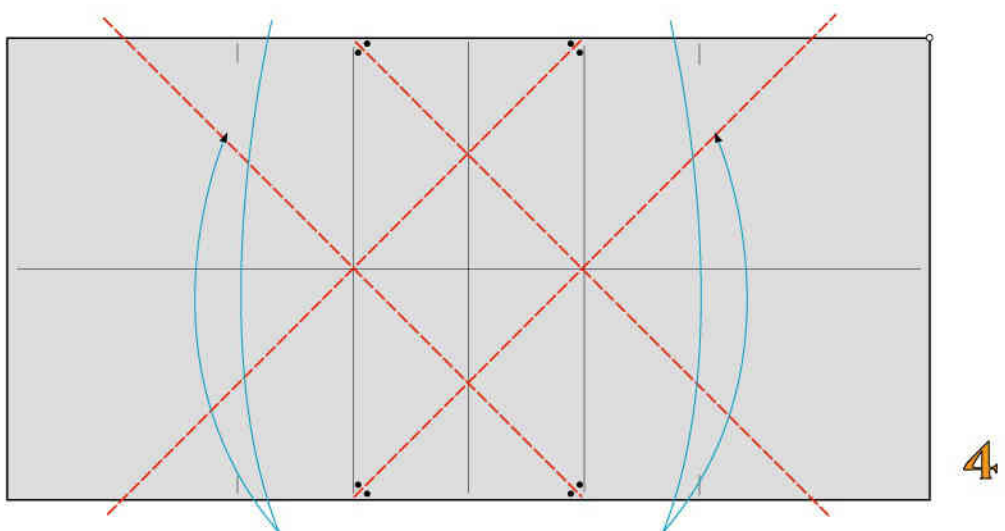

4 pieghe bisettrici a valle

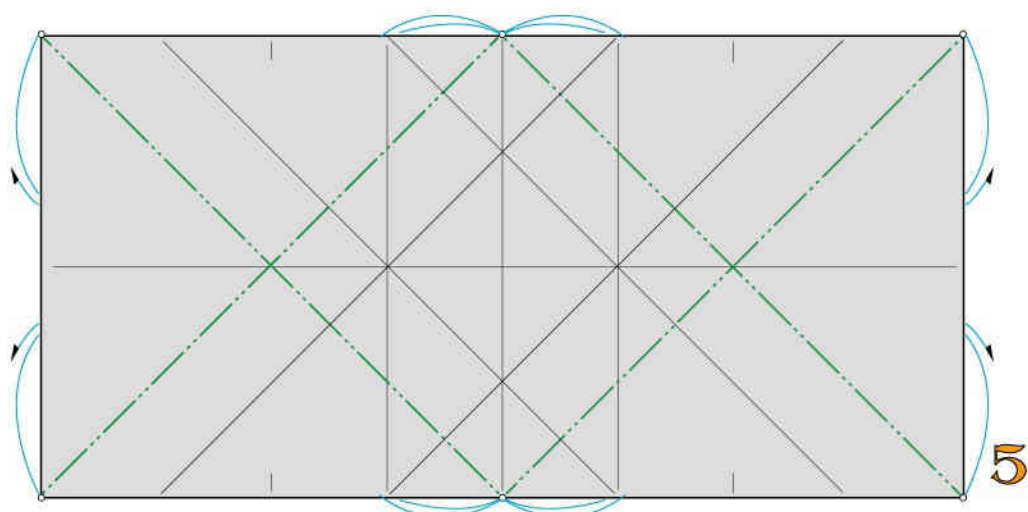

4 pieghe diagonali a monte

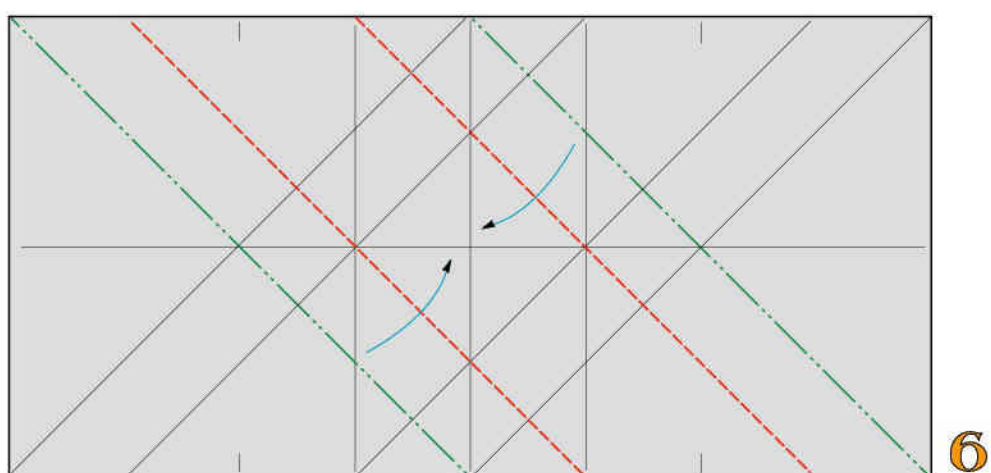

Ripiegate a valle e a monte

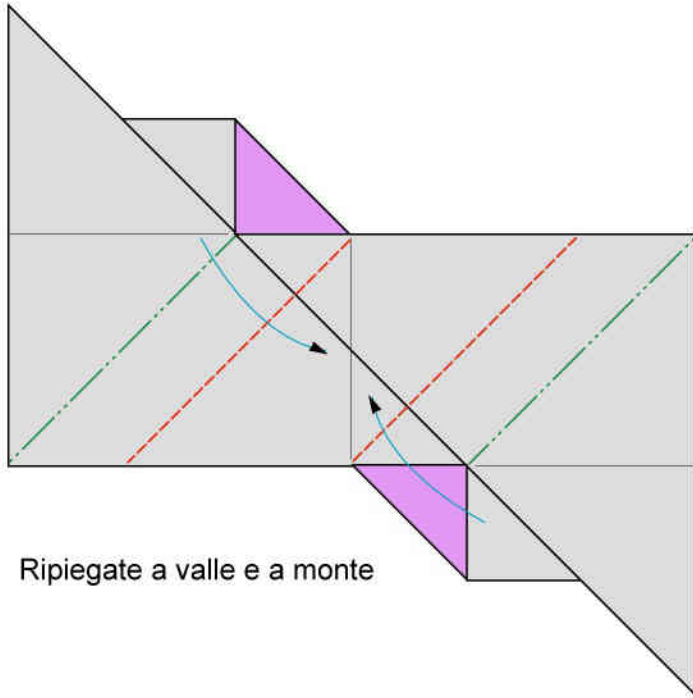

Ripiegate a valle e a monte

7

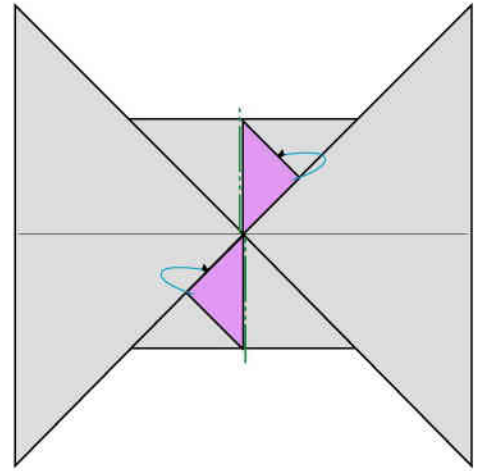

2 pieghe a monte e intascate

8

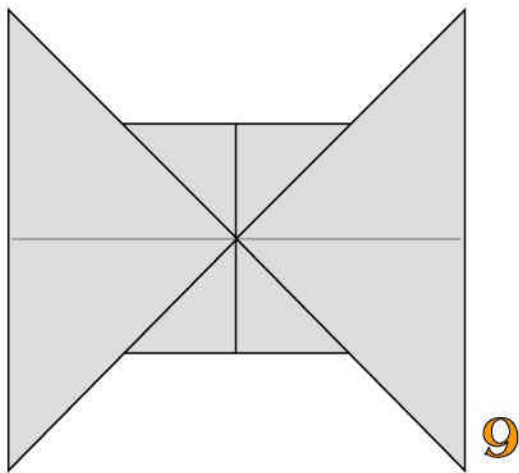

Modulo "M1" ultimato. Ribaltate

9

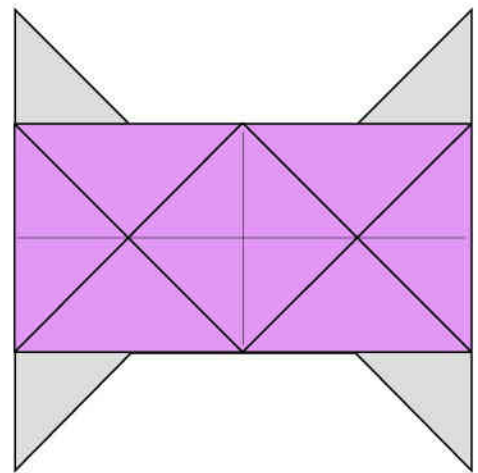

MODULO "M2"

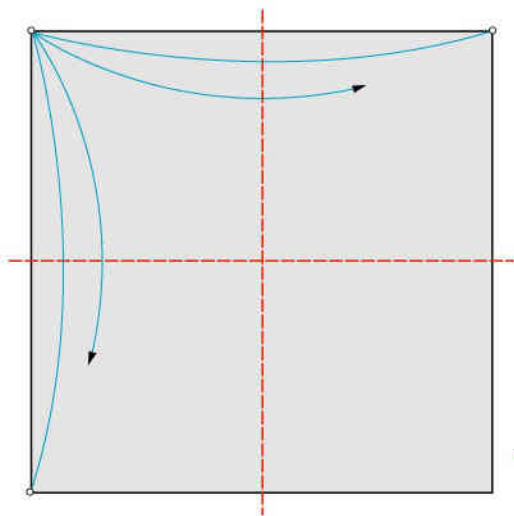

2 pieghe a valle

1

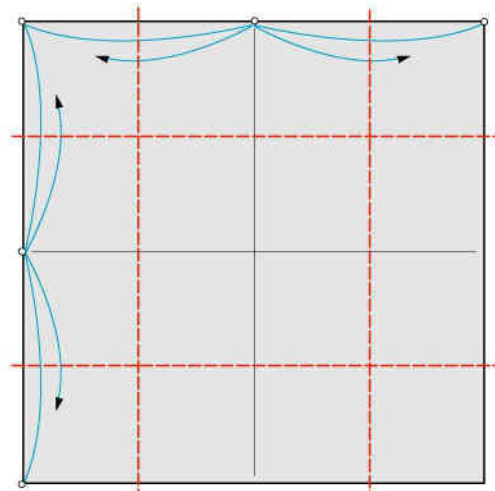

4 pieghe a valle

2

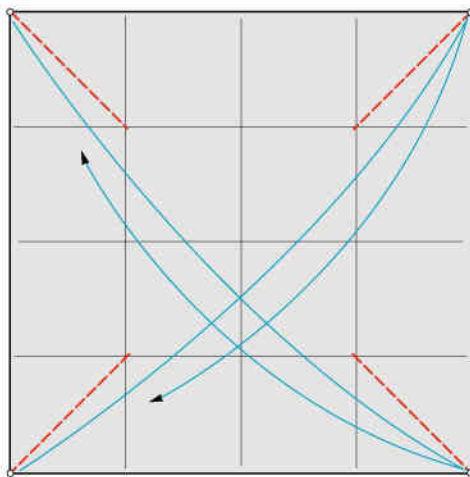

4 pieghe diagonali a valle

3

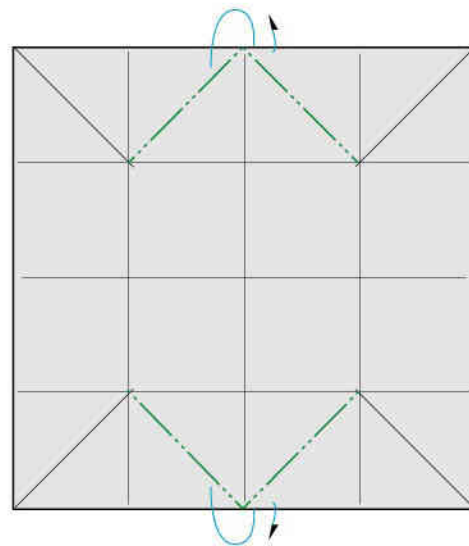

4 pieghe diagonali a monte

4

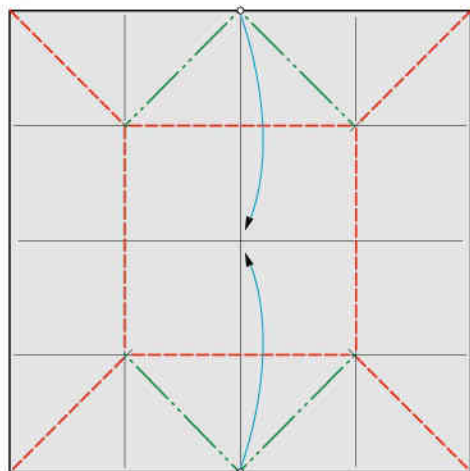

Ripiegate a valle e a monte

5

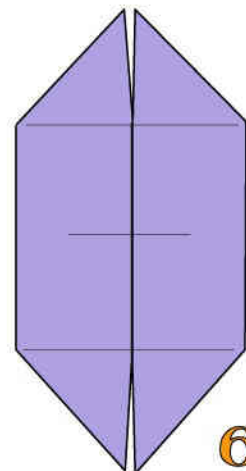

6

Modulo "M2" ultimato

UNIONE DEI MODULI

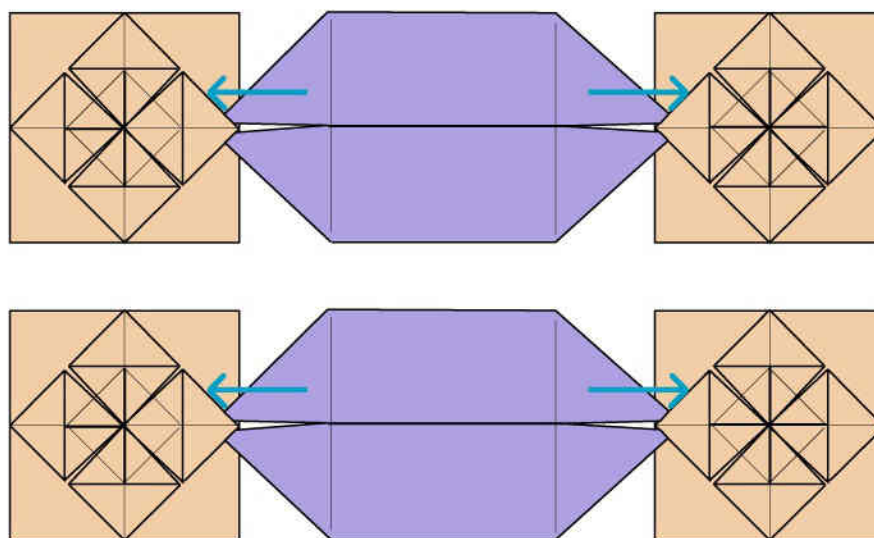

Unite 2 volte 2 moduli di bloccaggio con 1 modulo "M2"

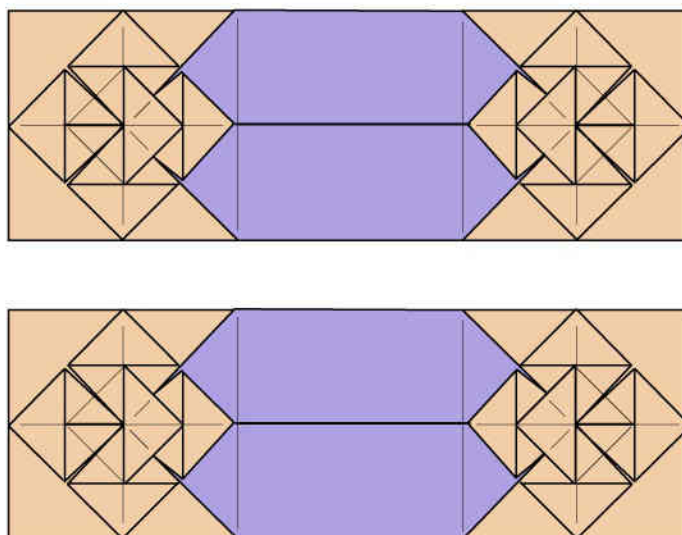

Mediante pieghe a monte bloccate
l'unione nel solito modo

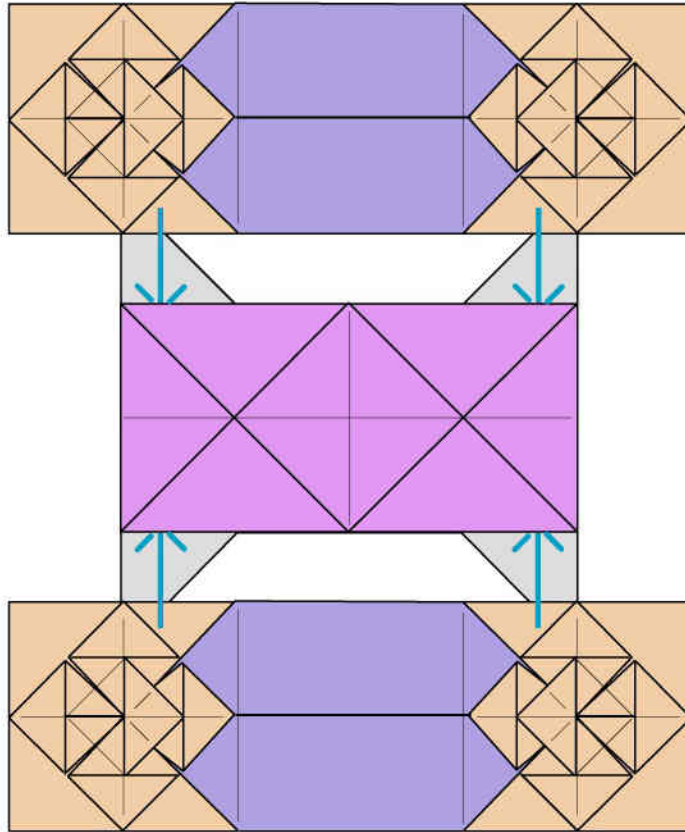

Unite con 1 modulo "M1"

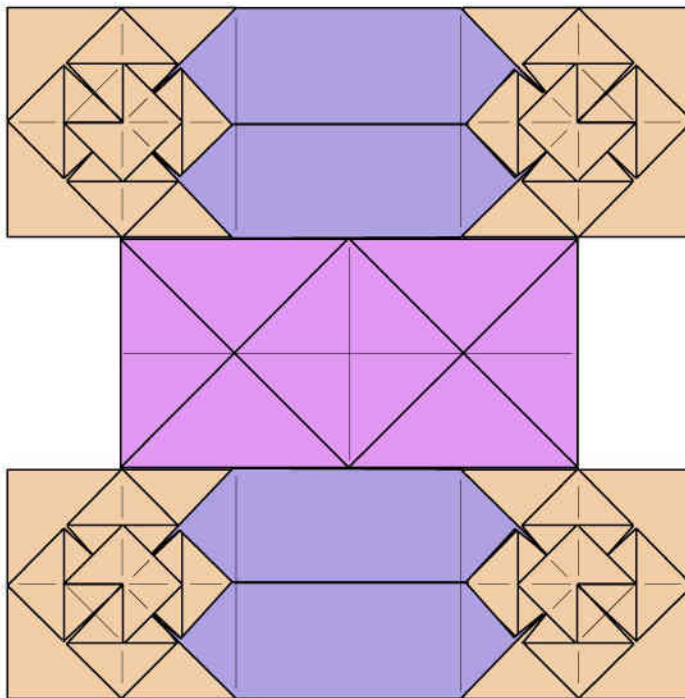

Mediante pieghe a monte bloccate
l'unione nel solito modo

TASSELLAZIONE "N"

MODULARE TRAFORATA

Franco Pavarin 23

La tassellazione "N" è formata dall'unione di moduli "N1" e "N2".
Adoperate fogli monocolori o bicolori di medio peso.

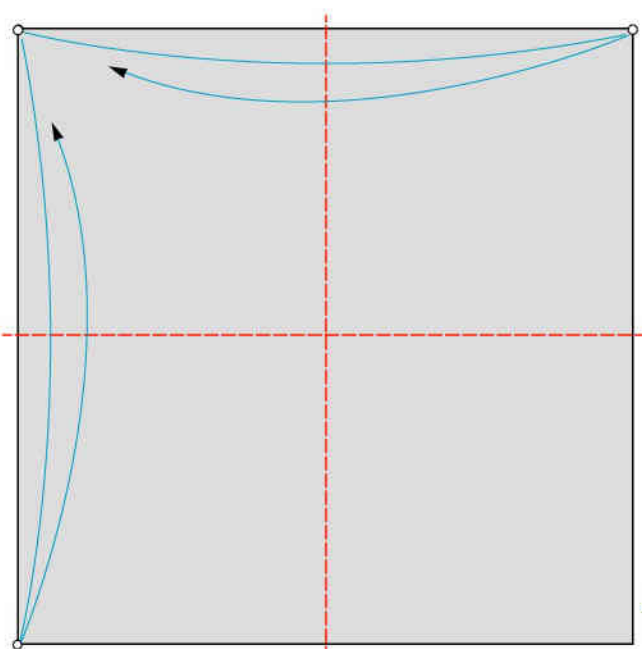

2 pieghe a valle

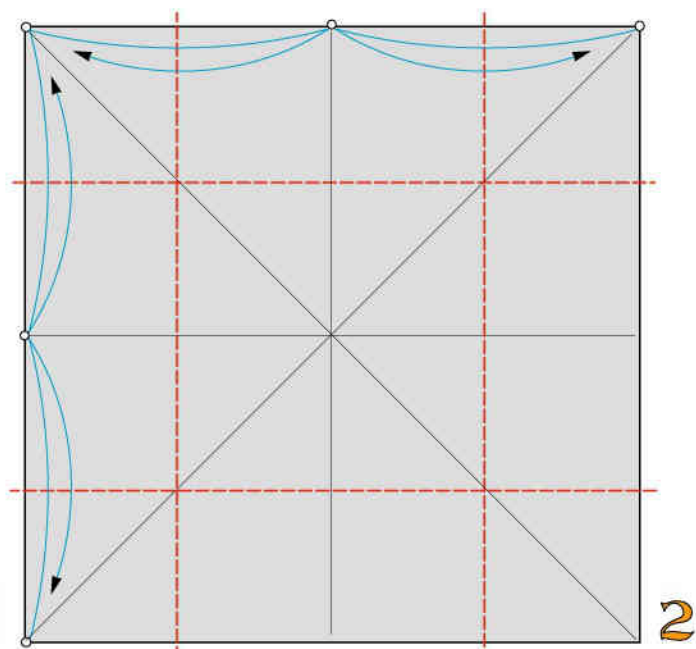

4 pieghe a valle

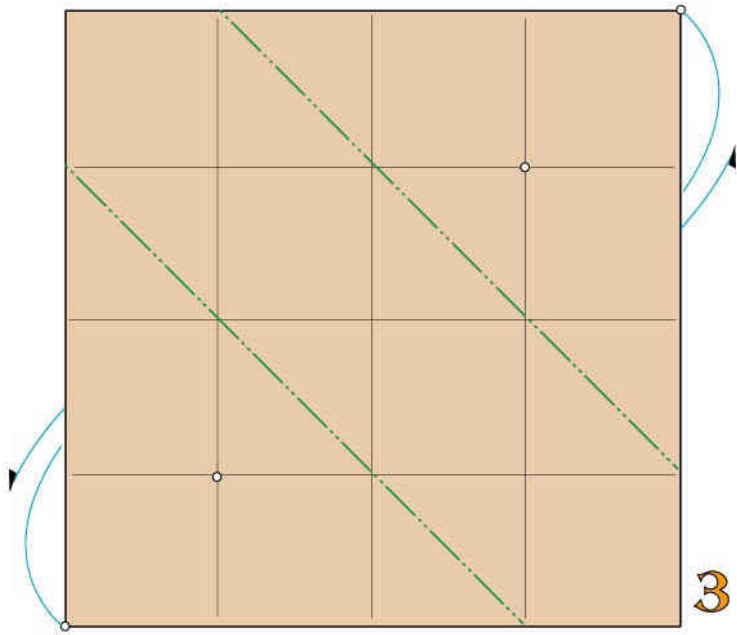

2 pieghe diagonali a monte

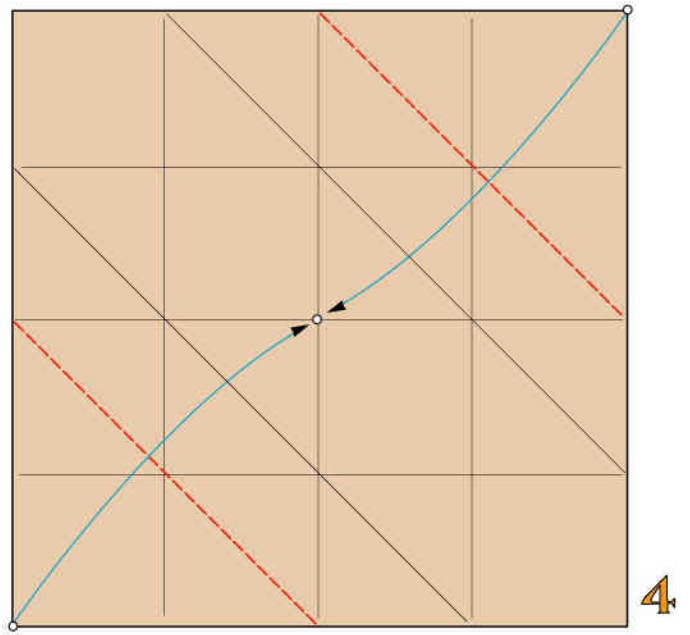

2 pieghe diagonali a valle

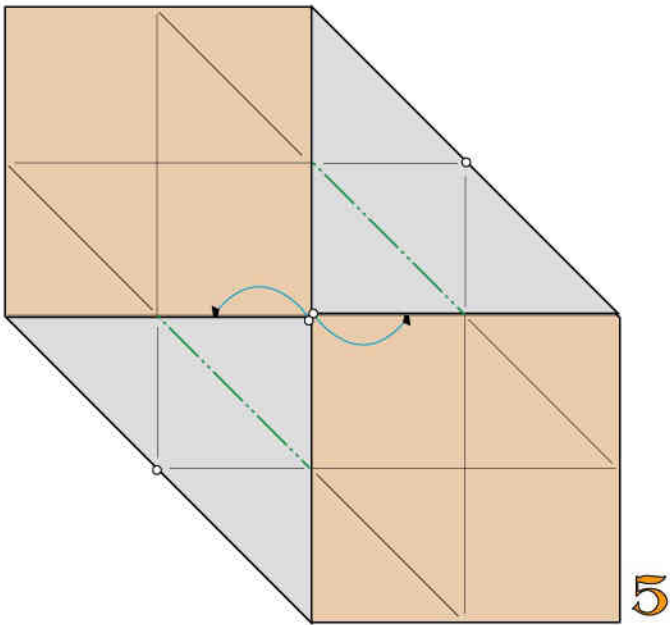

2 pieghe diagonali a monte

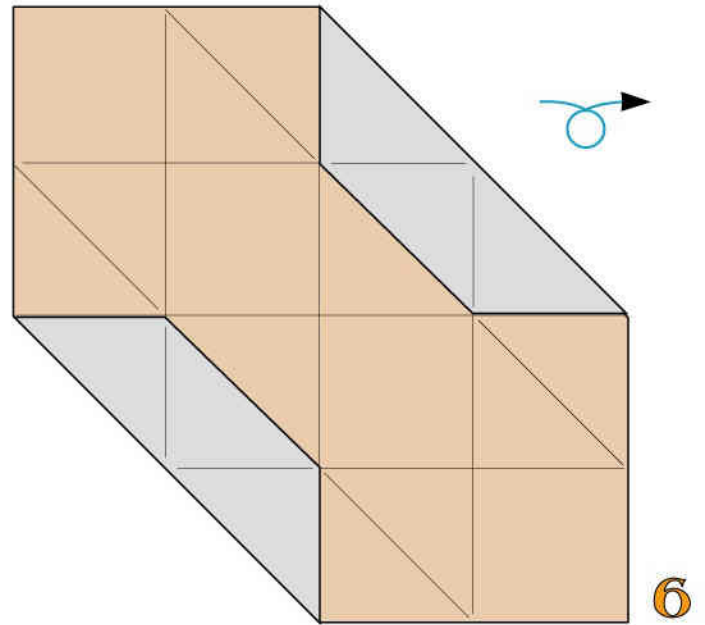

Ribaltate

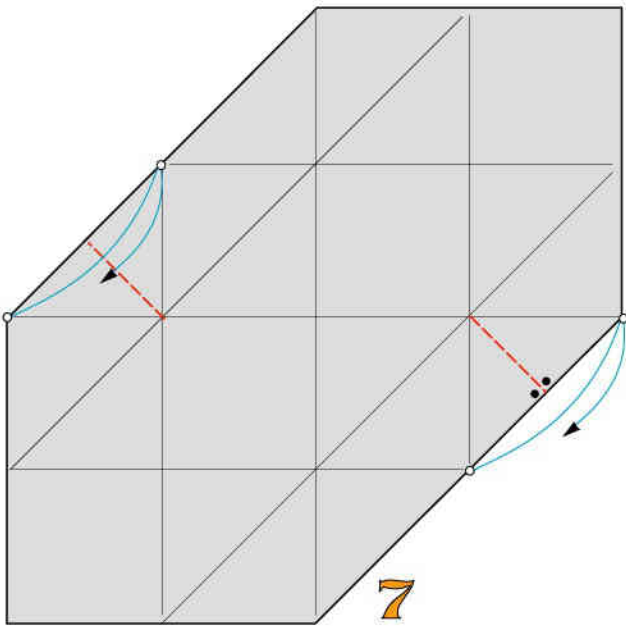

7

2 pieghe a valle

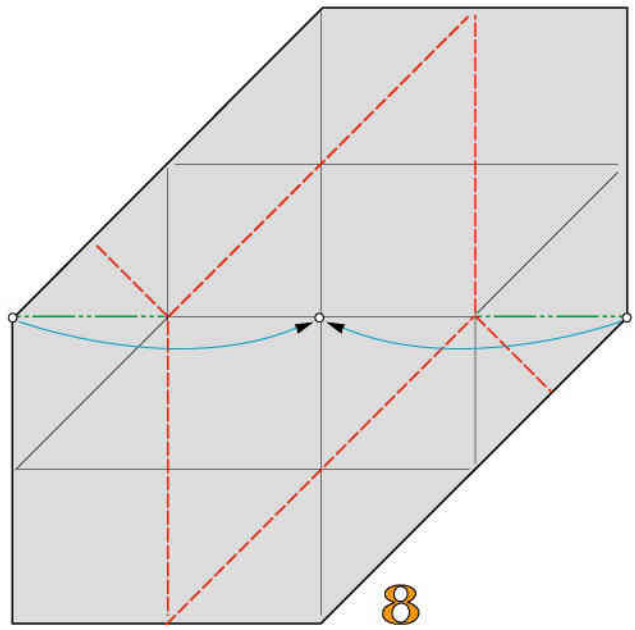

8

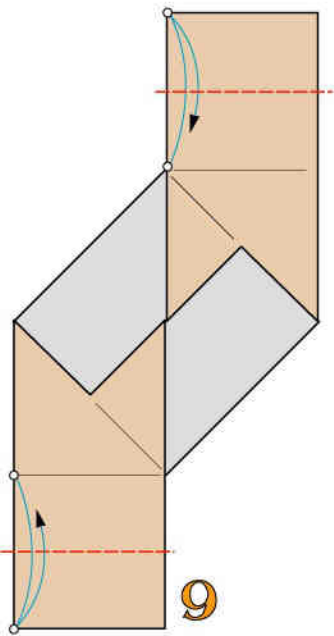

9

2 pieghe a valle

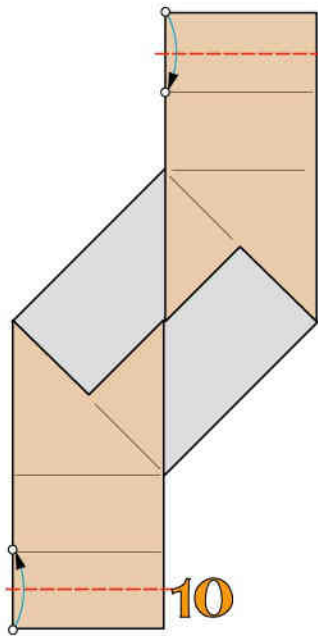

10

2 pieghe a valle

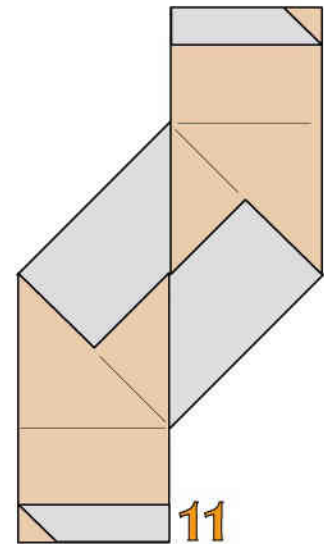

11

Modulo N1 ultimato

COSTRUZIONE DEL MODULO "N2"

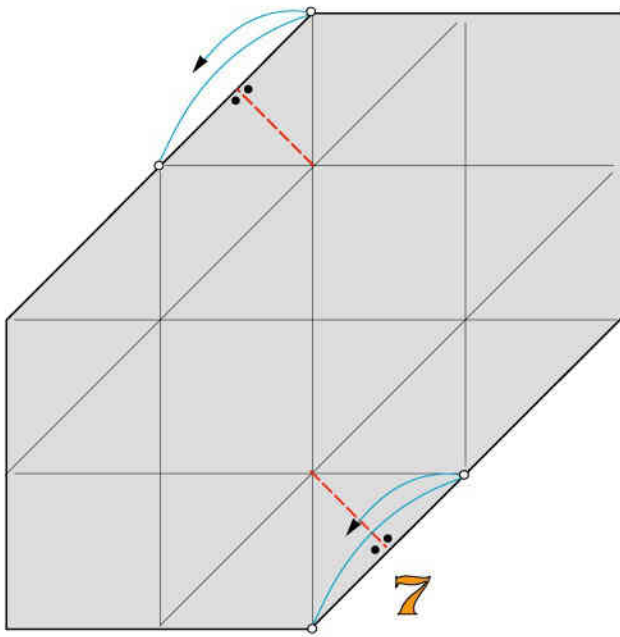

Partite dalla fig. n. 6 della tassellazione "N"

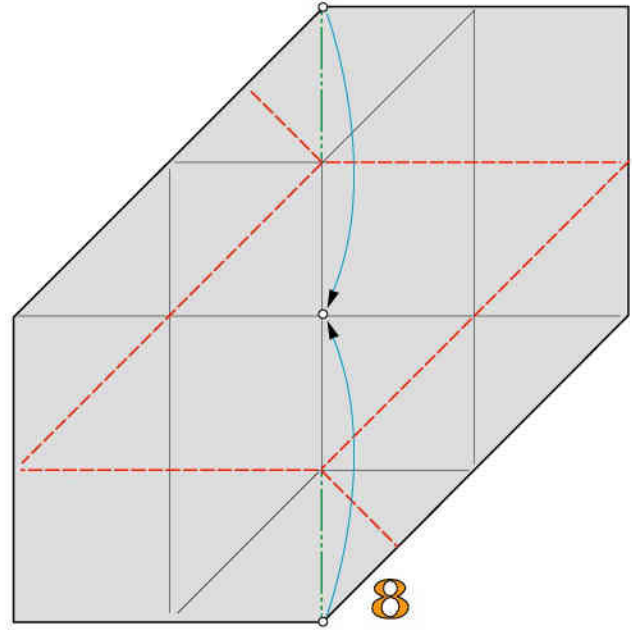

Ripiegate a valle e a monte

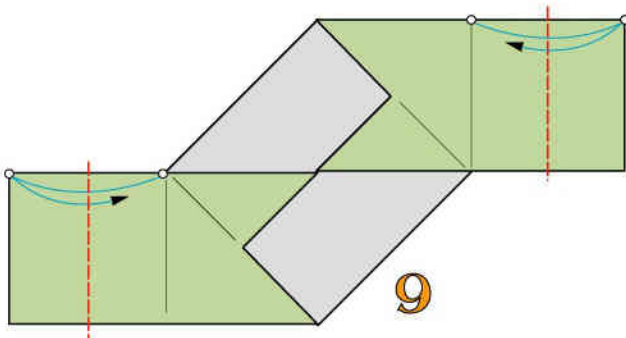

2 pieghe a valle

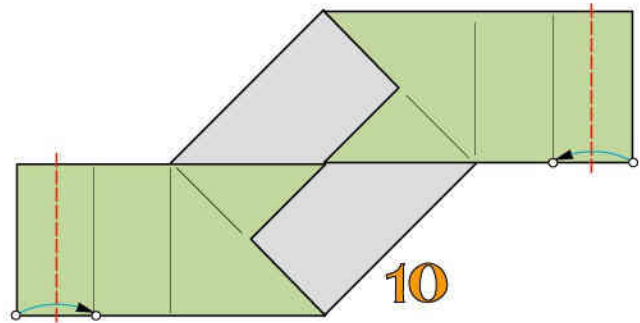

2 pieghe a valle

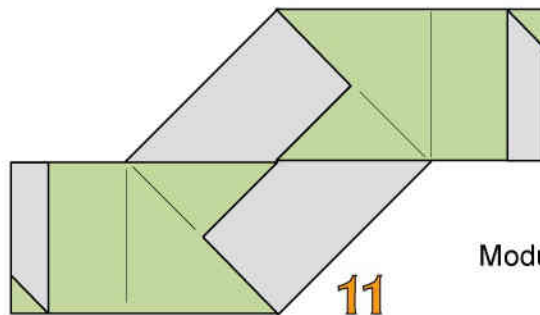

Modulo N2 ultimato

UNIONE DEI MODULI

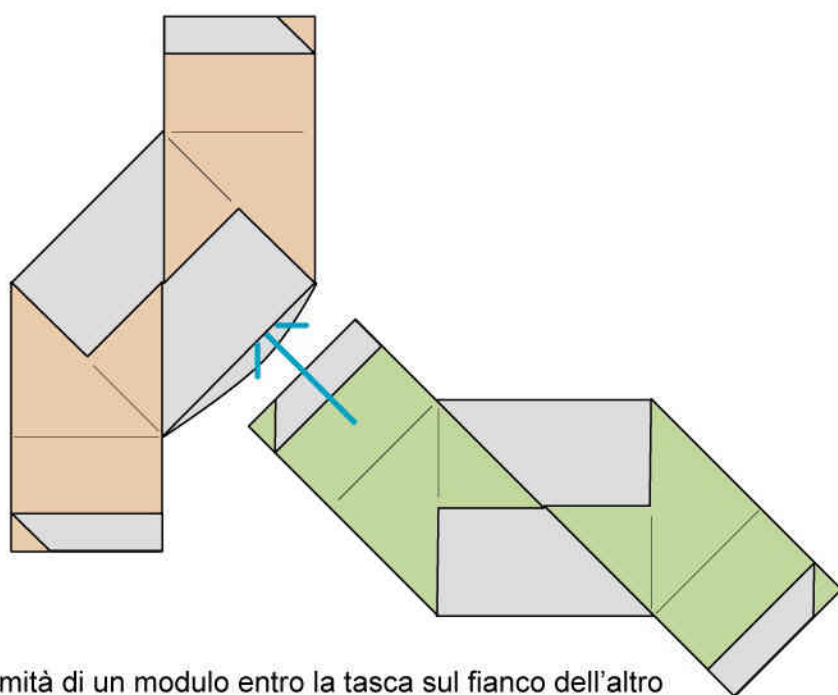

Intascate l'estremità di un modulo entro la tasca sul fianco dell'altro

1

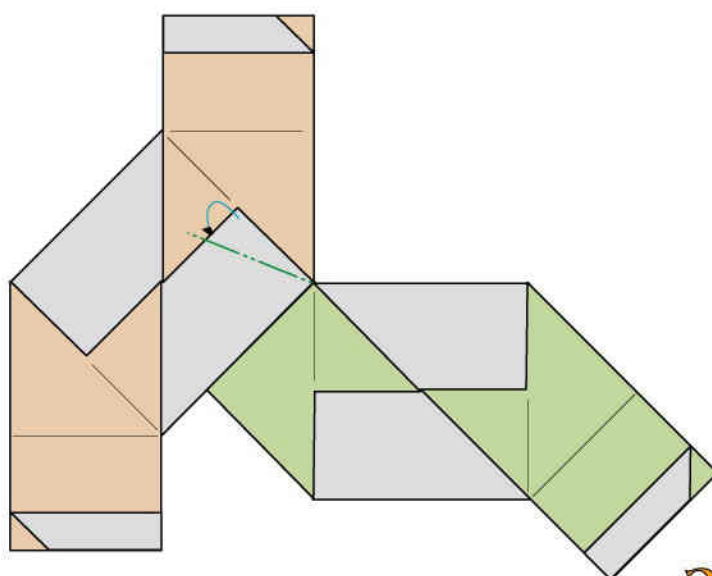

Mediante una piega a monte bloccate l'unione

2

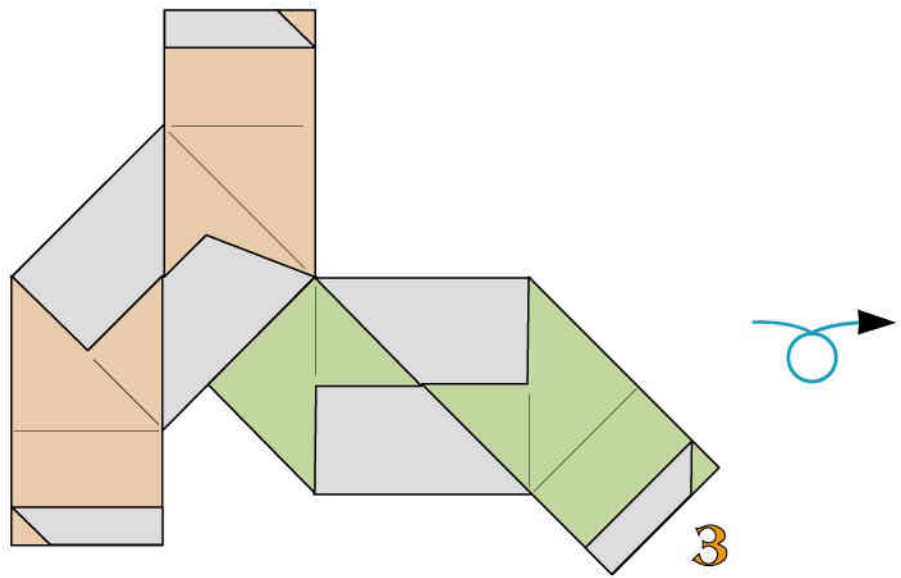

Ribaltate

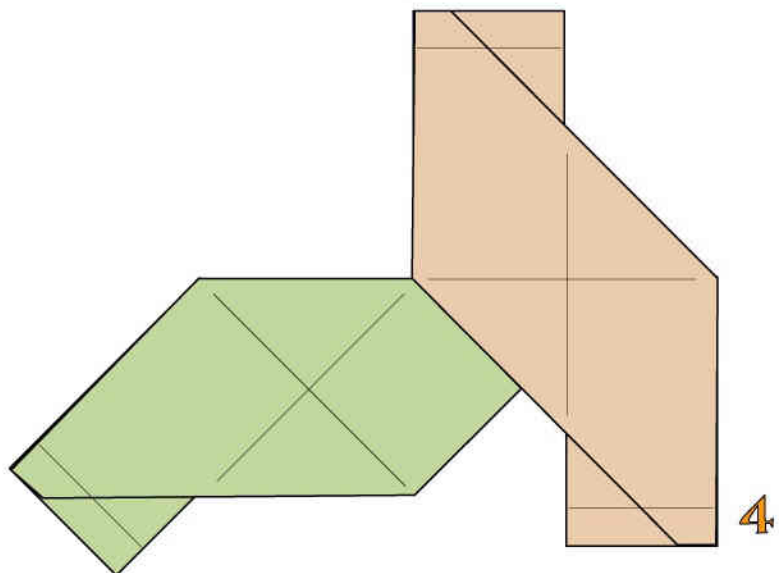

TASSELLAZIONE MODULARE COMPATTA "O"



Adoperare fogli di carta bicolore
leggera delle dimensioni di cm 10x10

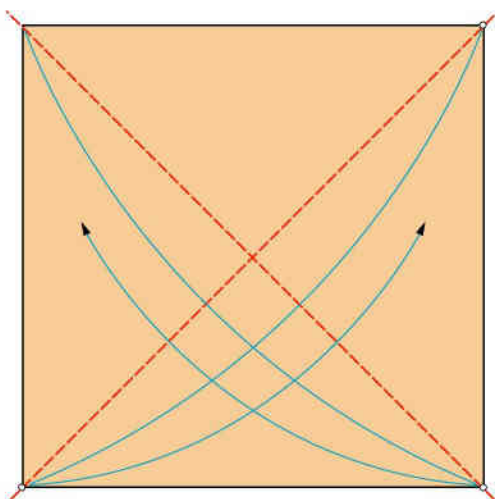

2 pieghe diagonali a valle

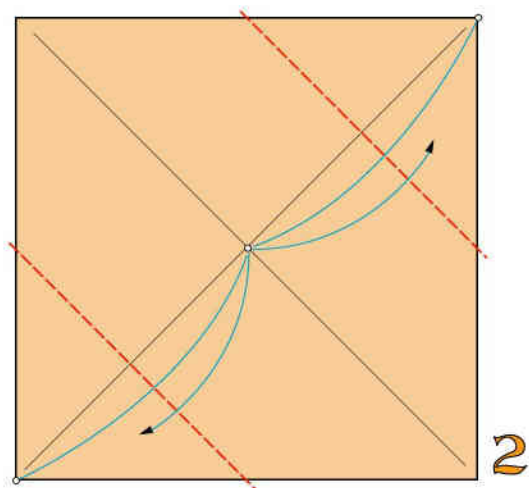

2 pieghe a valle



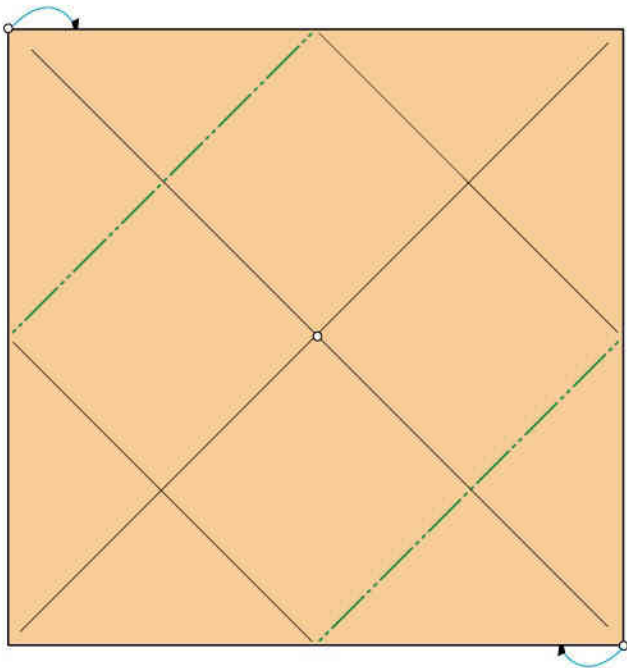

2 pieghe a monte

3

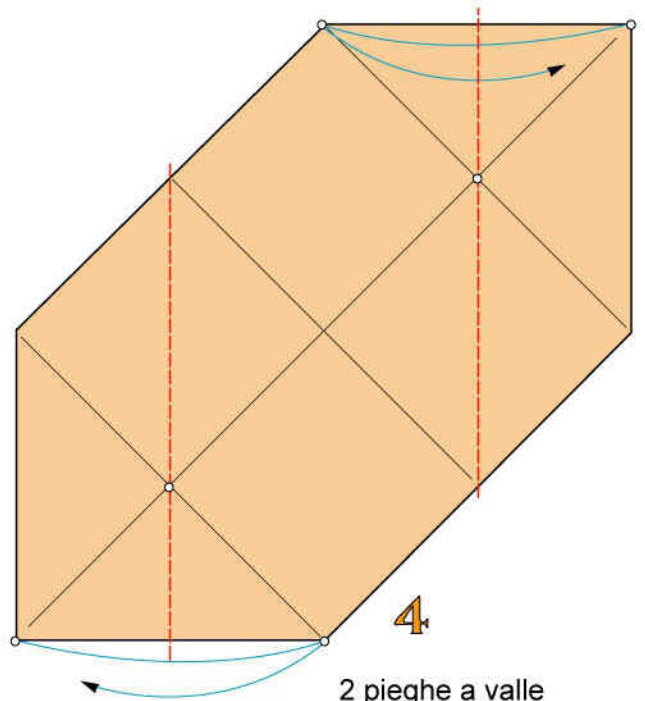

2 pieghe a valle

4

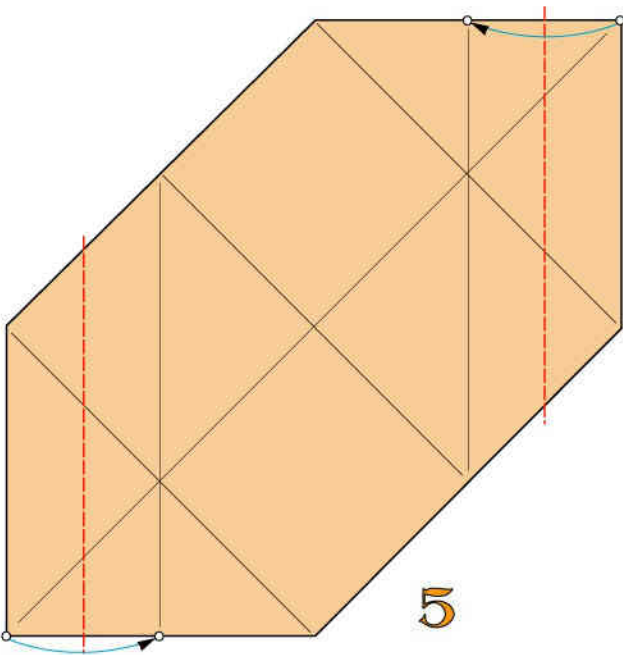

2 pieghe a valle

5

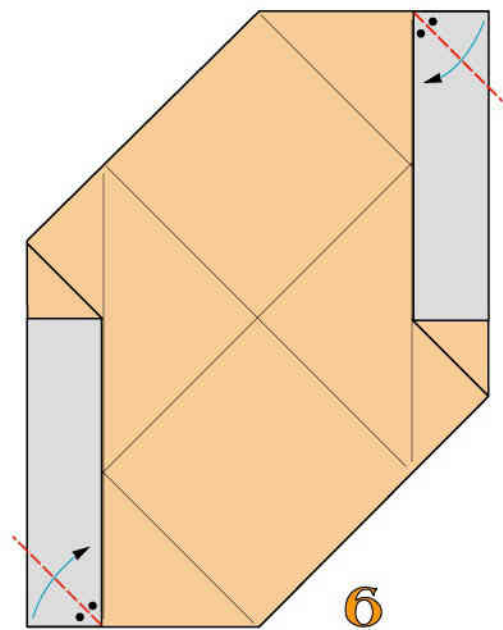

2 pieghe bisettrici a valle

6

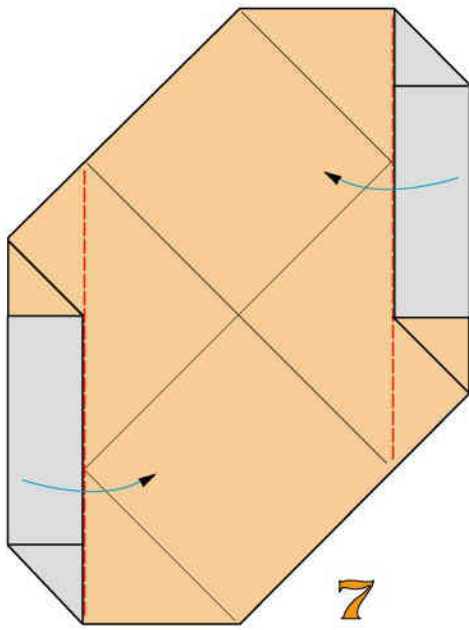

7

Ripiegate a valle

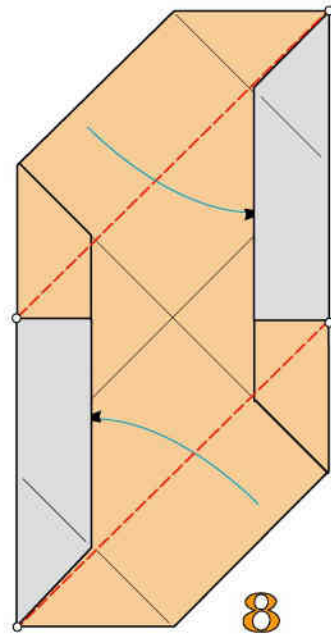

8

2 pieghe a valle

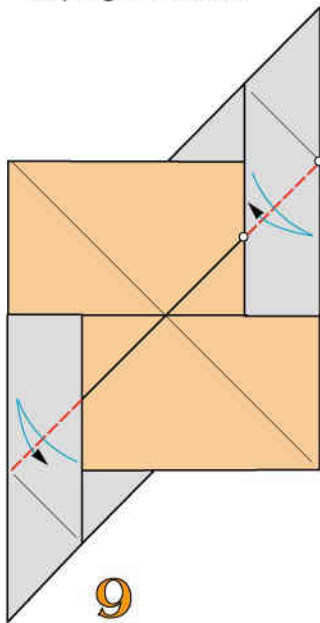

9

2 pieghe a valle

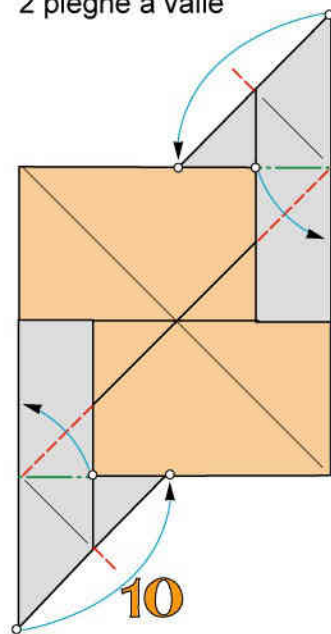

10

Ripiegate a valle e a monte

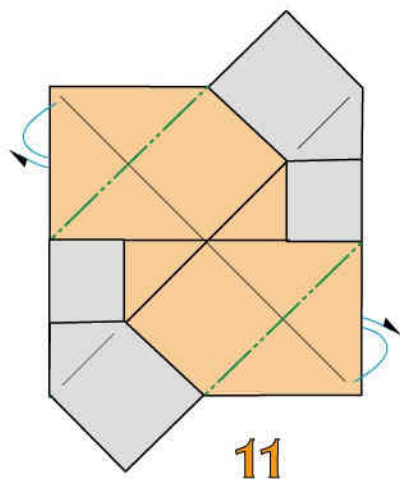

11

2 pieghe a monte

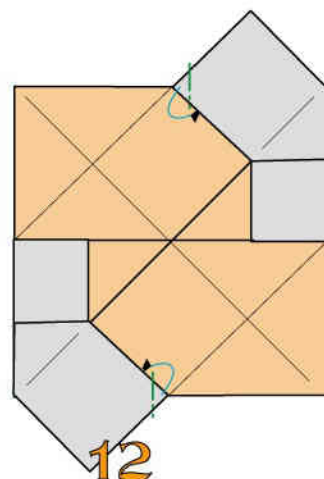

12

2 pieghe a monte

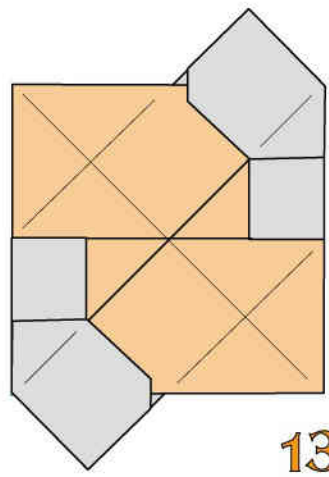

Modulo ultimato

13

UNIONE DI 2 MODULI

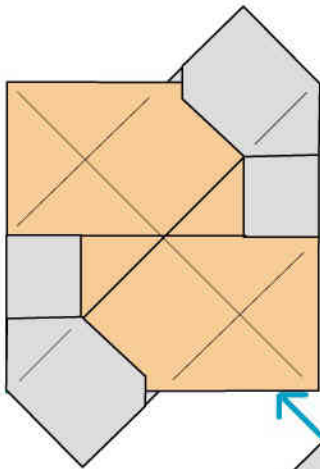

Inserite il modulo inferiore
entro la tasca di quello superiore

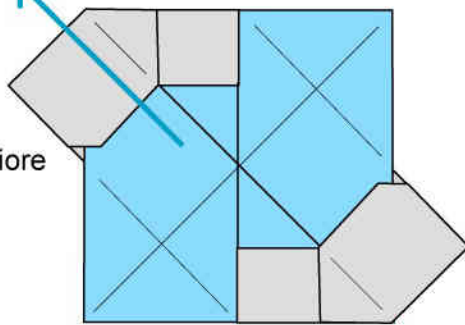

1

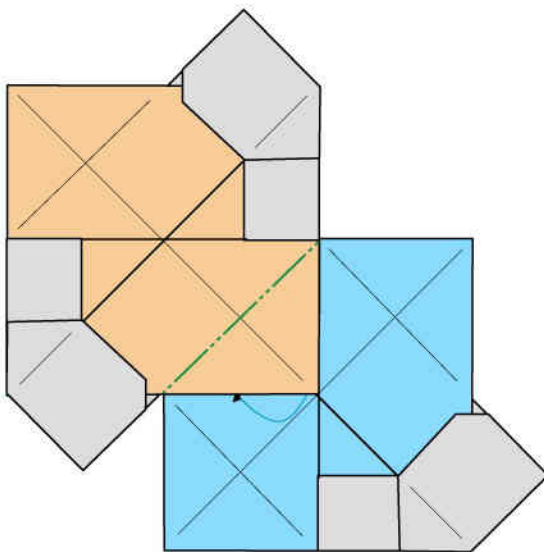

2

Mediante una piega a valle bloccate l'unione

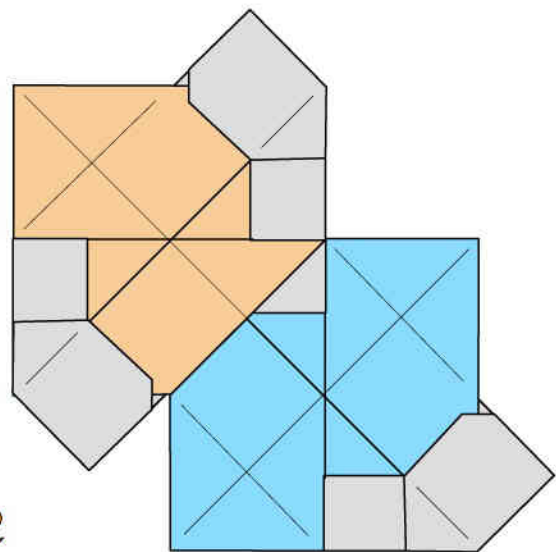

3

Unione di 2 moduli ultimata

TORRE MODULARE TRAFORATA "A"

Franco Pavarin 23

Sono necessari moduli "A" e moduli di bloccaggio, da costruire con fogli quadrati monocolori di carta di medio peso di cm 7,5 x7,5.

Per la costruzione del solido di figura sono stati adoperati 20 moduli "A" e 20 moduli di bloccaggio.

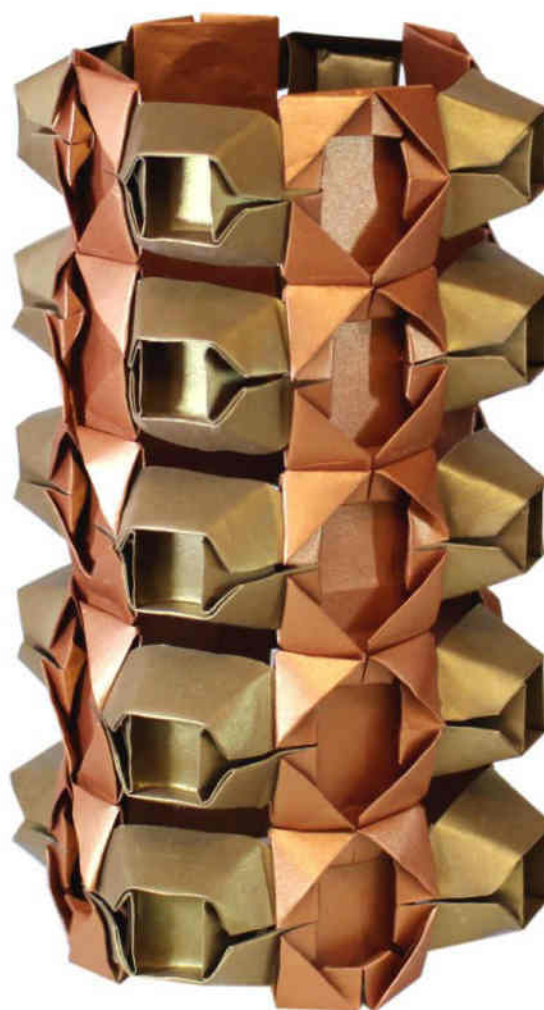

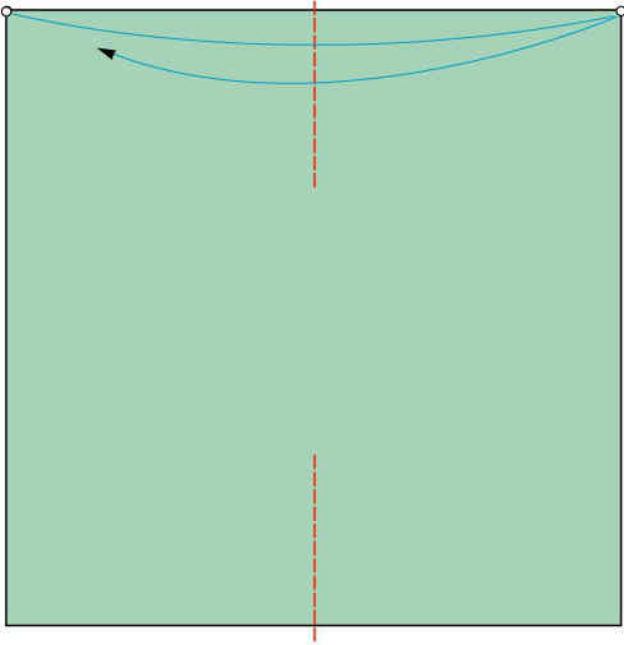

2 pieghe a valle

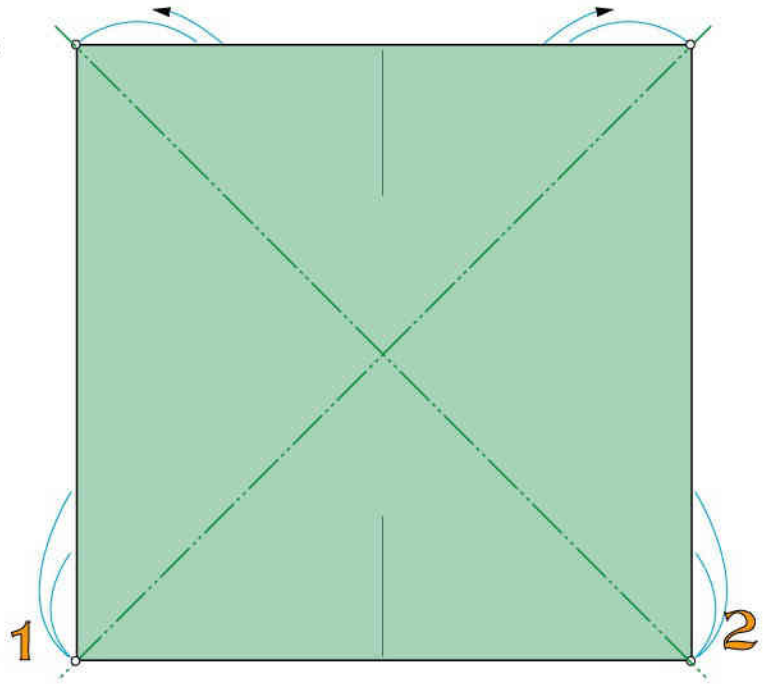

2 pieghe diagonali a monte

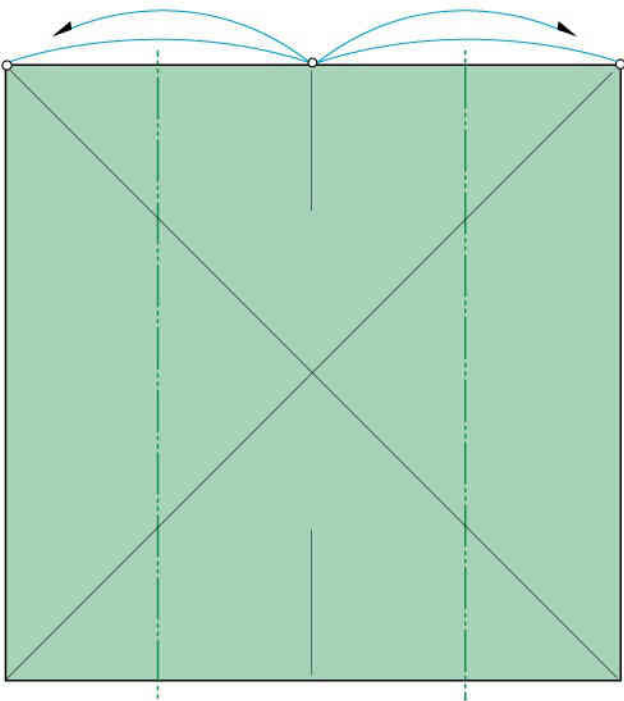

2 pieghe a monte

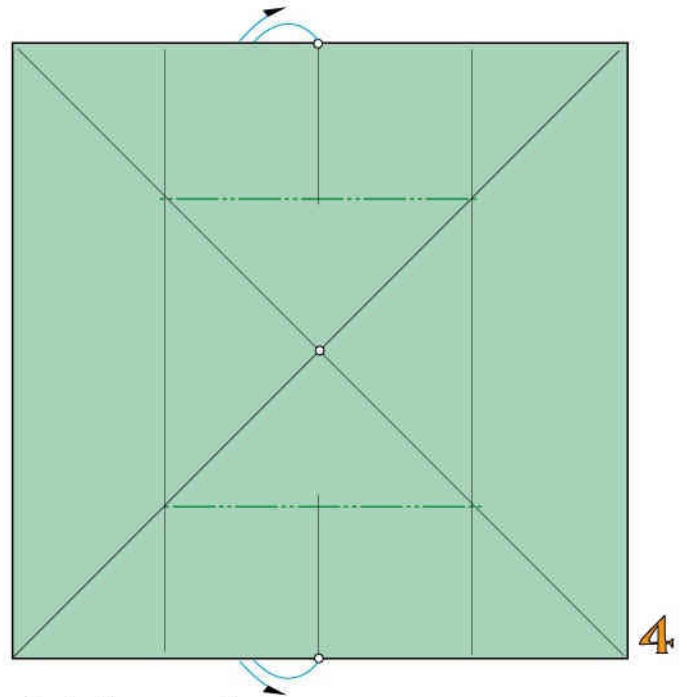

2 pieghe a monte

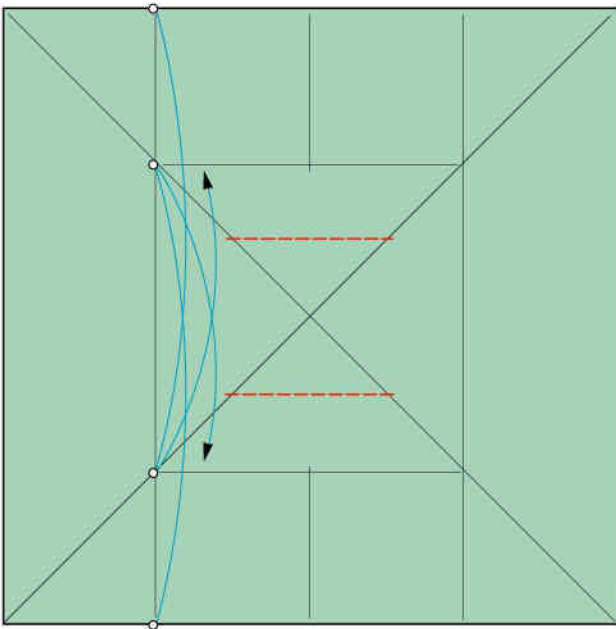

5

2 pieghe a valle

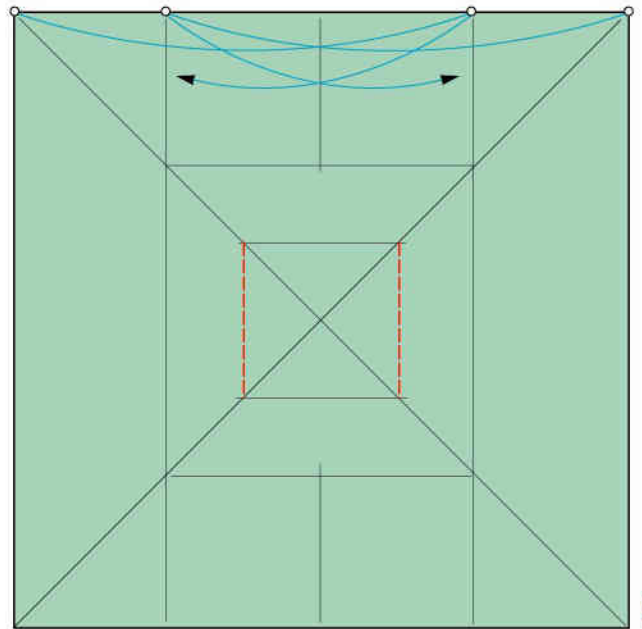

6

2 pieghe a valle

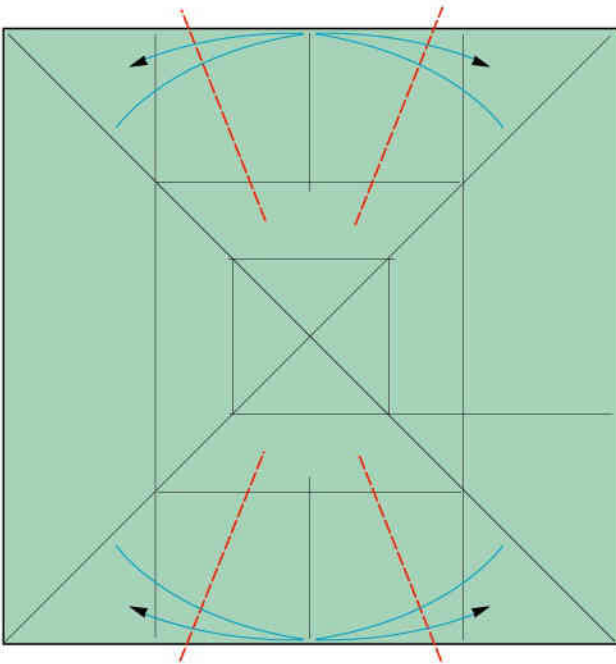

7

4 pieghe bisettrici a valle

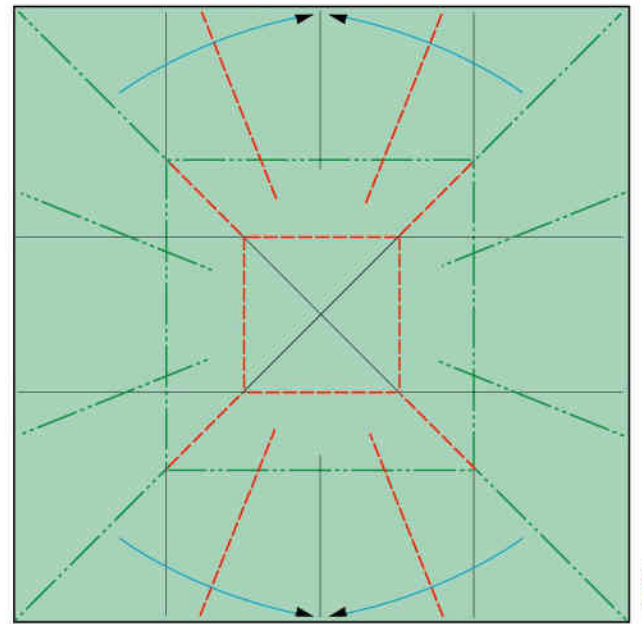

8

4 pieghe bisettrici a monte ripiegando a valle e a monte

2 pieghe a valle

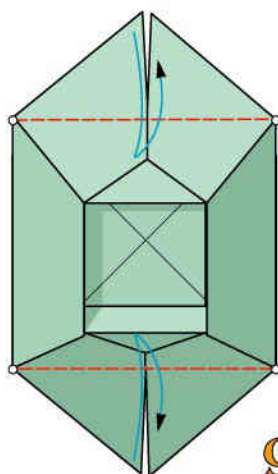

9

Modulo torre
"A" ultimato

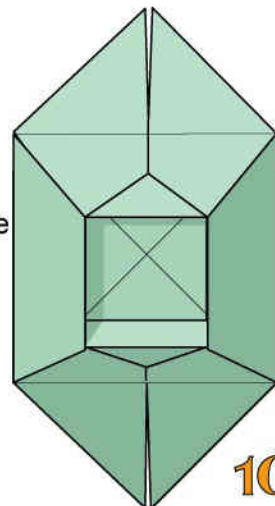

10

UNIONE DEI MODULI

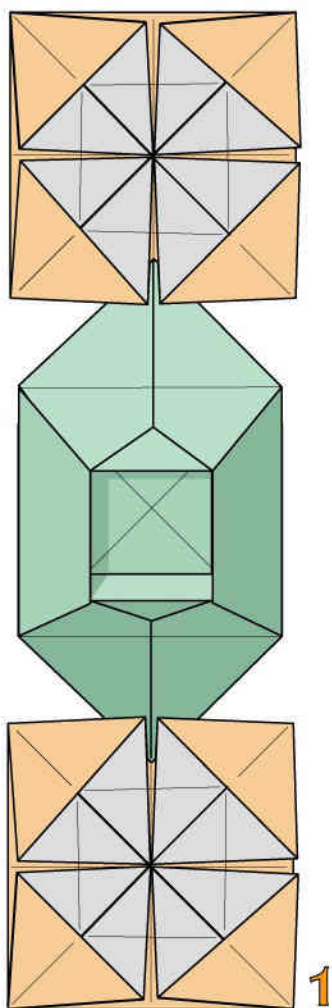

Inserite il modulo "A" entro
2 moduli di bloccaggio

1

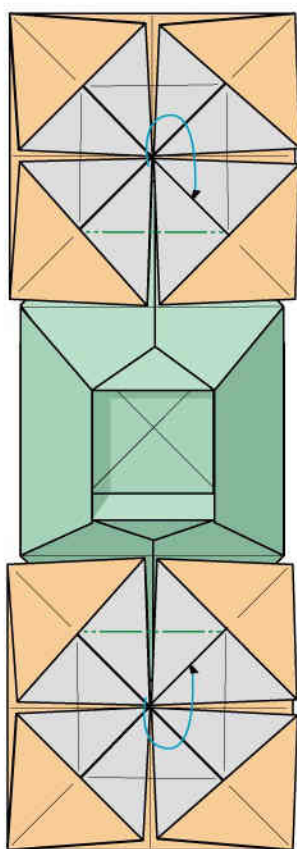

Mediante 2 pieghe a monte
bloccate l'unione

2

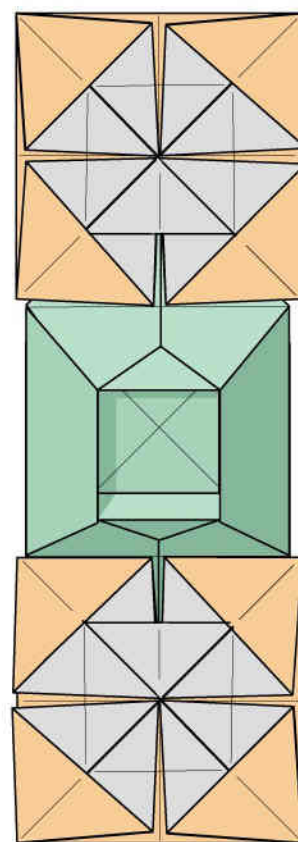

Unione completata

3

TORRE MODULARE TRAFORATA "A1"

Franco Pavarin 23

Sono necessari moduli "A" e moduli di bloccaggio, da costruire con fogli quadrati monocolori di carta di medio peso di cm 7,5 x7,5.

Per la costruzione del solido di figura sono stati adoperati 20 moduli "A" ribaltati e 20 moduli di bloccaggio.

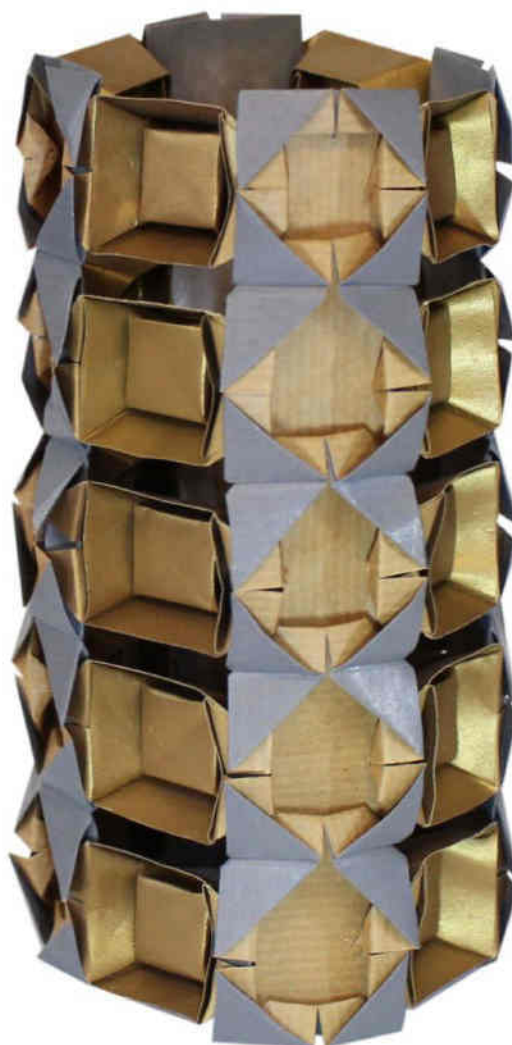

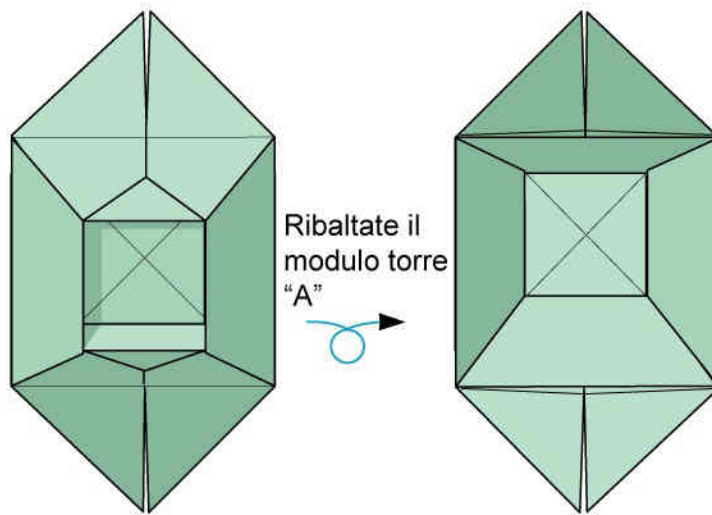

UNIONE DEI MODULI

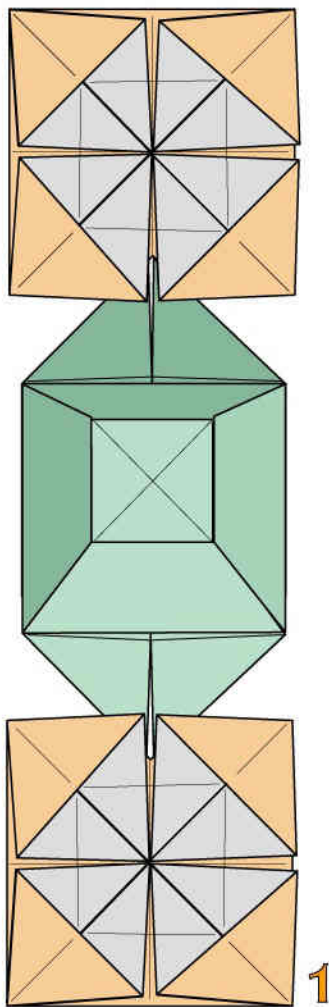

1 Inserite il modulo "A" entro 2 moduli di bloccaggio

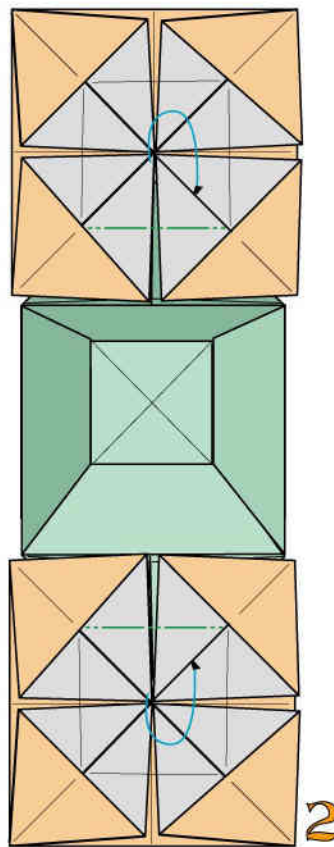

2 Mediante 2 pieghe a monte bloccate l'unione

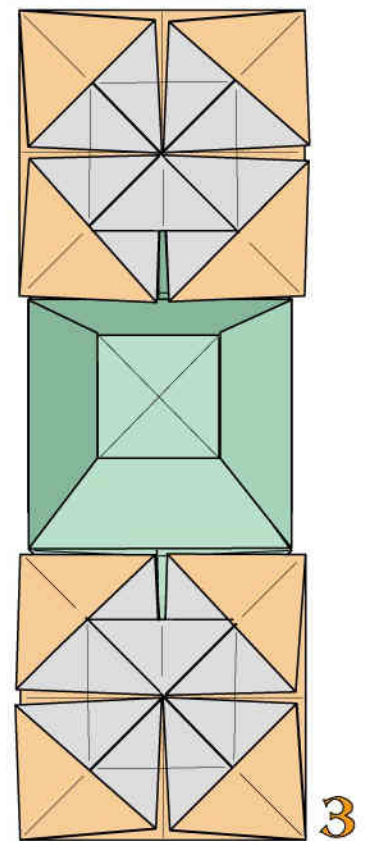

3 Unione completata

TORRE MODULARE COMPATTA "B"

Franco Pavarin 23

Sono necessari moduli "B" e moduli di bloccaggio, da costruire con fogli quadrati monocolori di carta di medio peso di cm 7,5 x7,5.
Per la costruzione del solido di figura sono stati adoperati 20 moduli "A" e 6 moduli di bloccaggio.



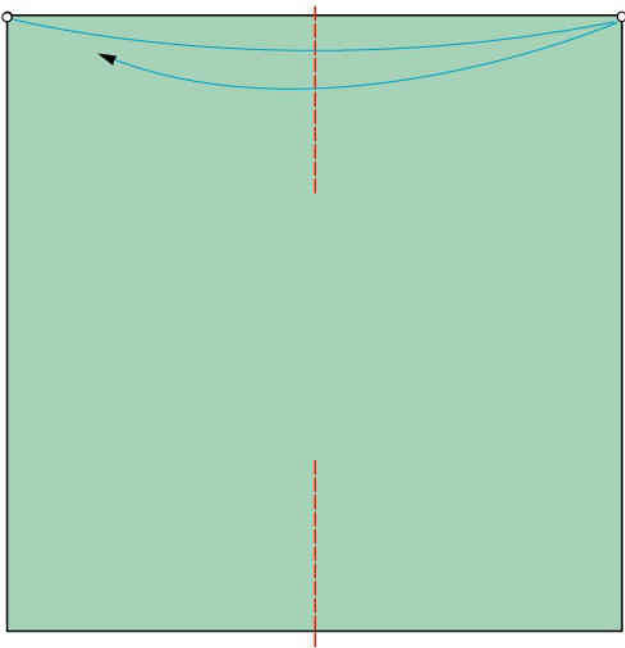

2 pieghe a valle

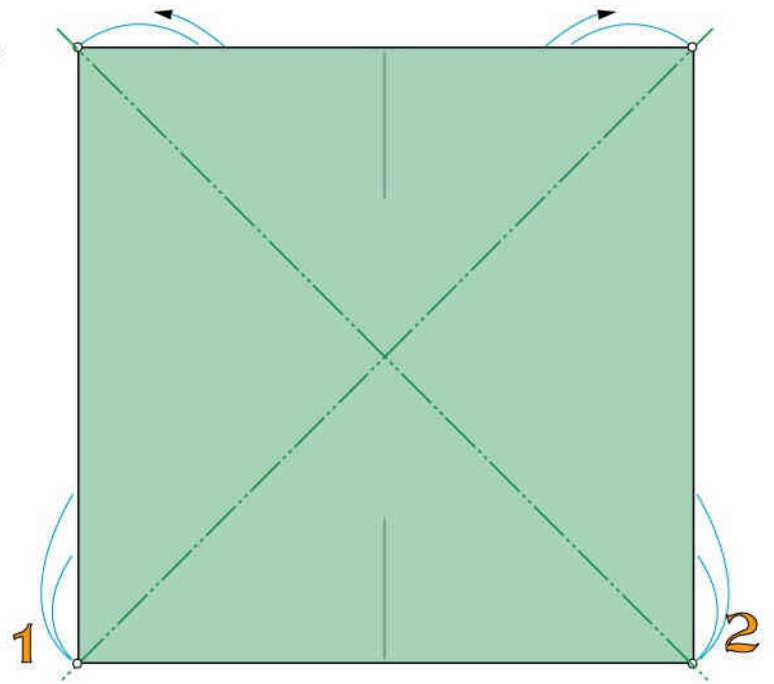

2 pieghe diagonali a monte

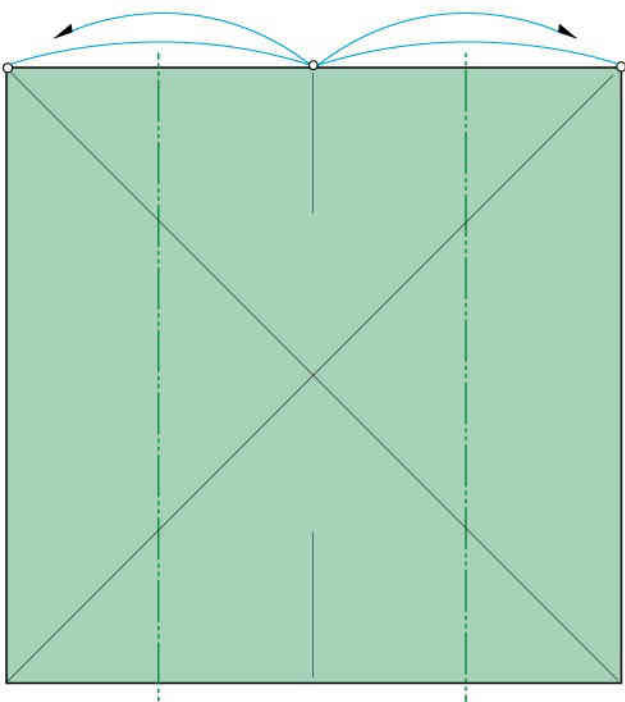

2 pieghe a monte

3

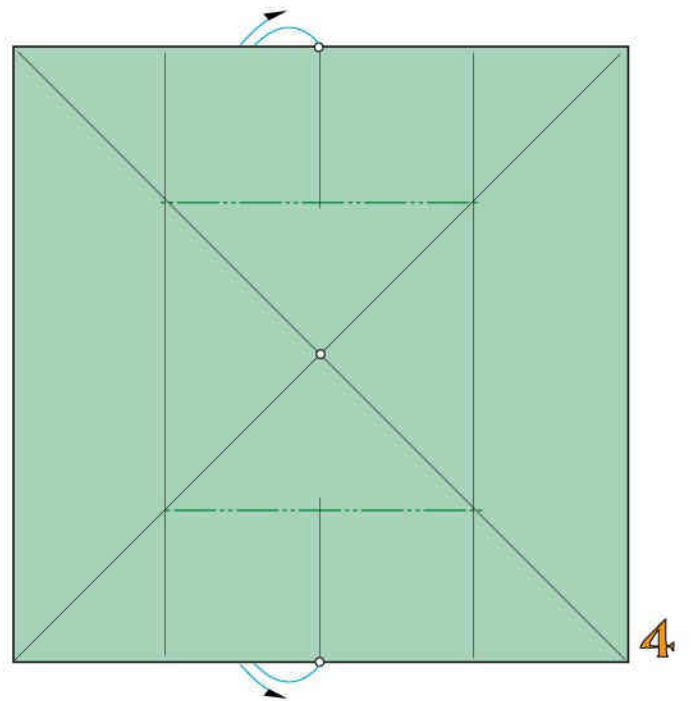

2 pieghe a monte

4

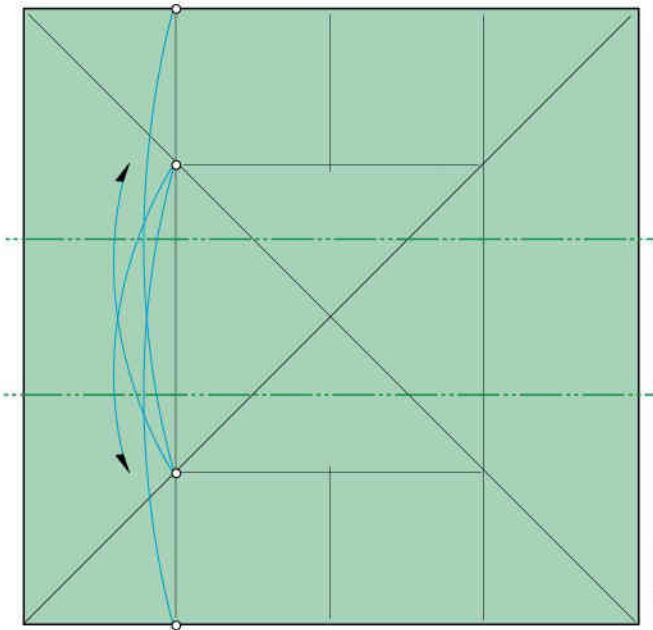

5

2 pieghe a monte

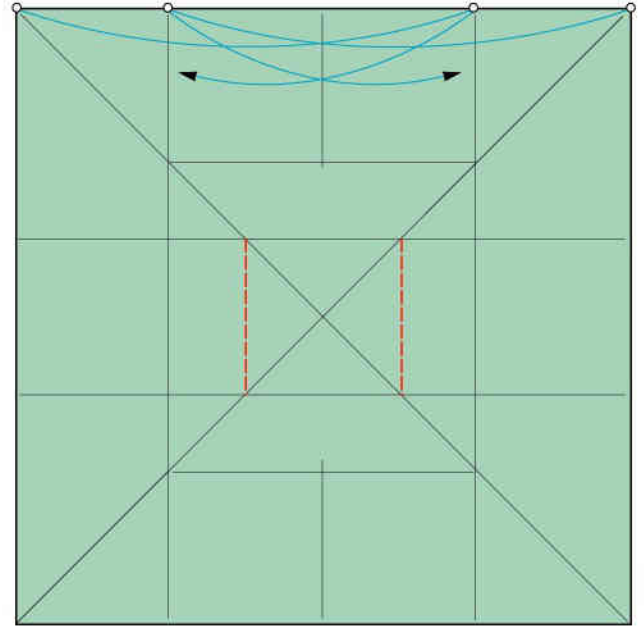

6

2 pieghe a valle

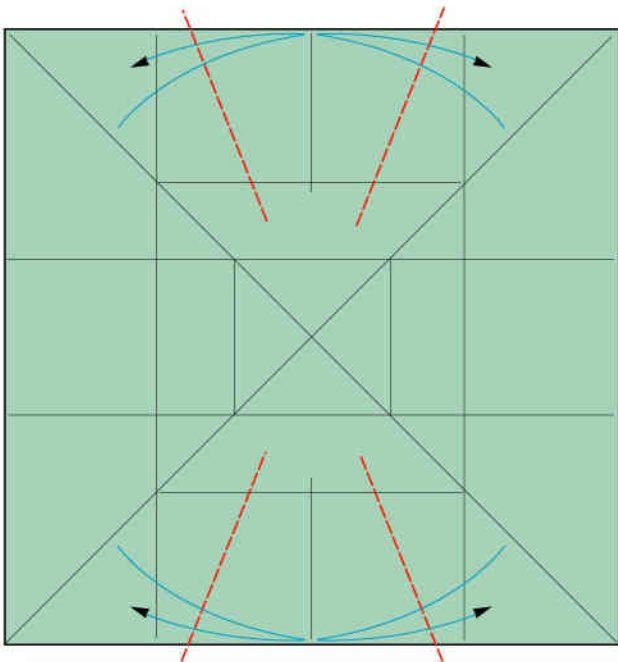

7

4 pieghe bisettrici a valle

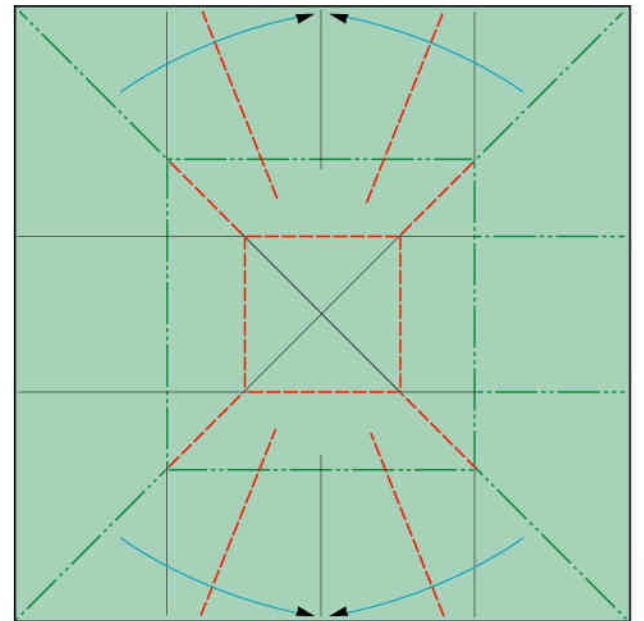

8

Ripiegate a valle e a monte modellando 3D

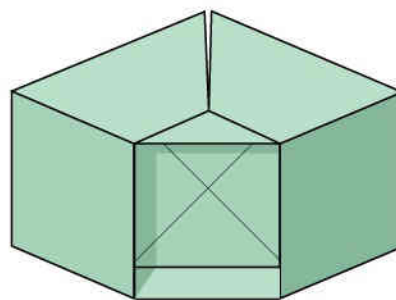

9

Modulo torre "B" ultimato

UNIONE DEI MODULI

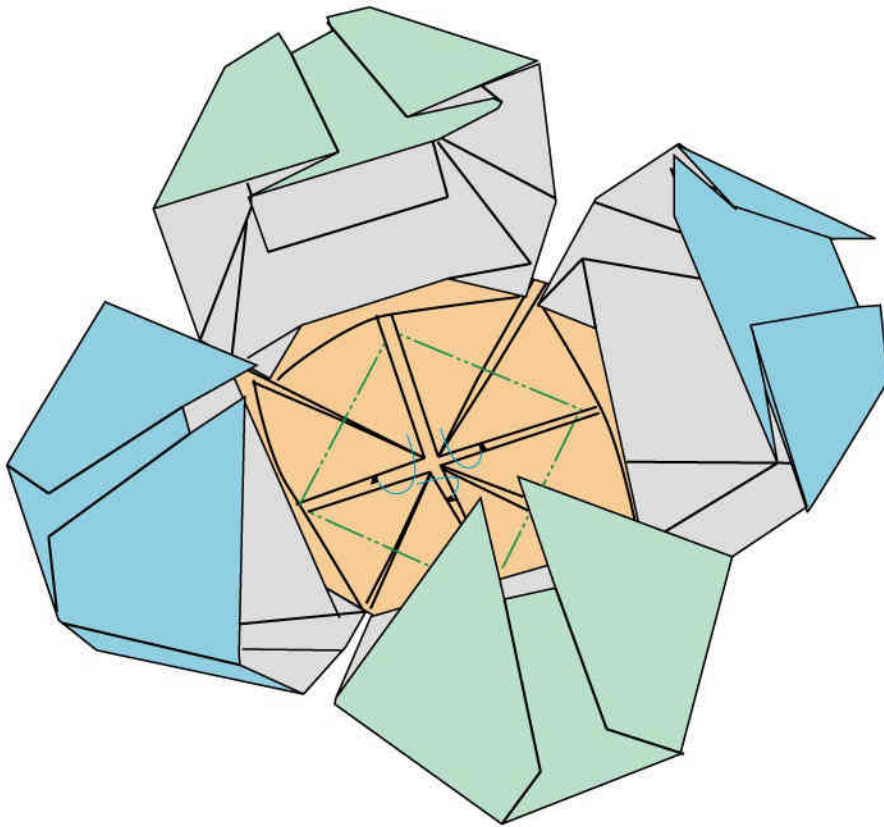

Inserite i 4 moduli "B" in un modulo di bloccaggio

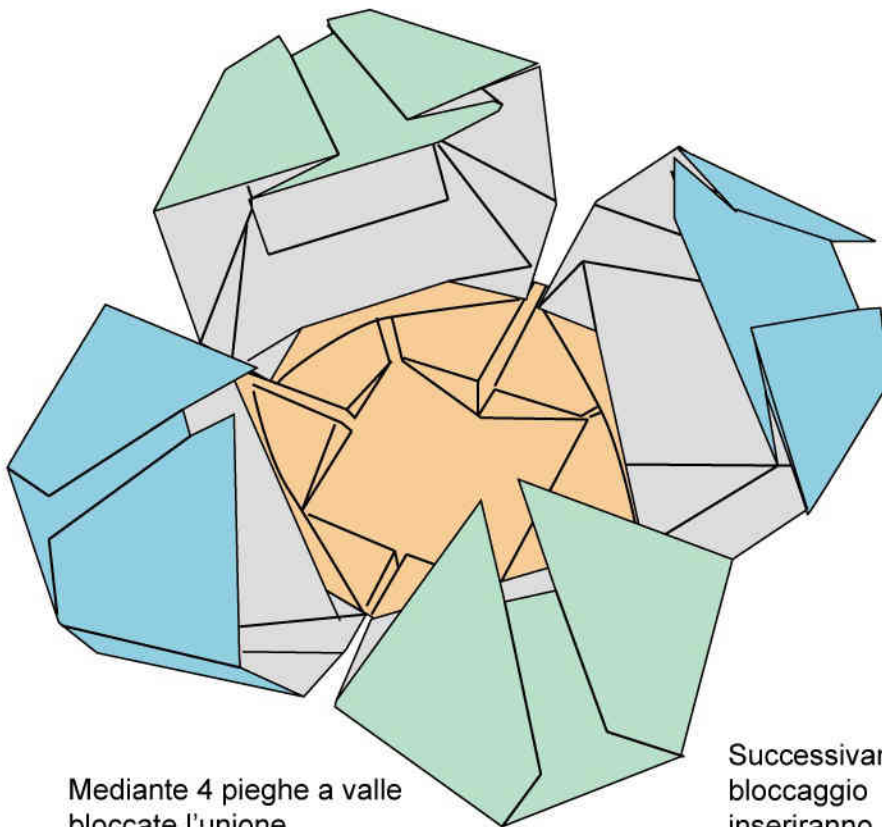

Mediante 4 pieghe a valle bloccate l'unione

Successivamente nel modulo di bloccaggio superiore si inseriranno 8 moduli "B"

POLIEDRO MODULARE TRAFORATO "A"

Franco Pavarin 23

Con questo modulo si possono costruire molti solidi.
Quello in fotografia è un icosaedro, cioè un solido regolare con 20 facce a triangolo equilatero.
Per la costruzione adoperate 30 fogli rettangolari monocolori di carta di medio peso di almeno cm 12x6

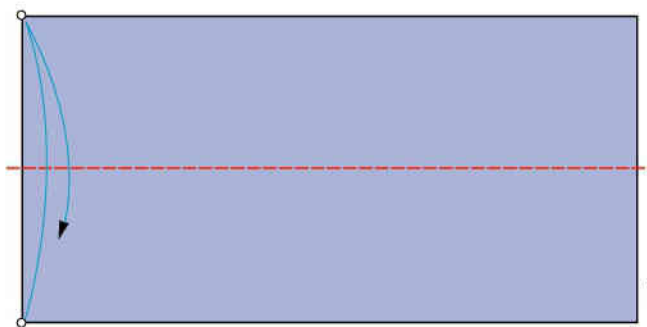
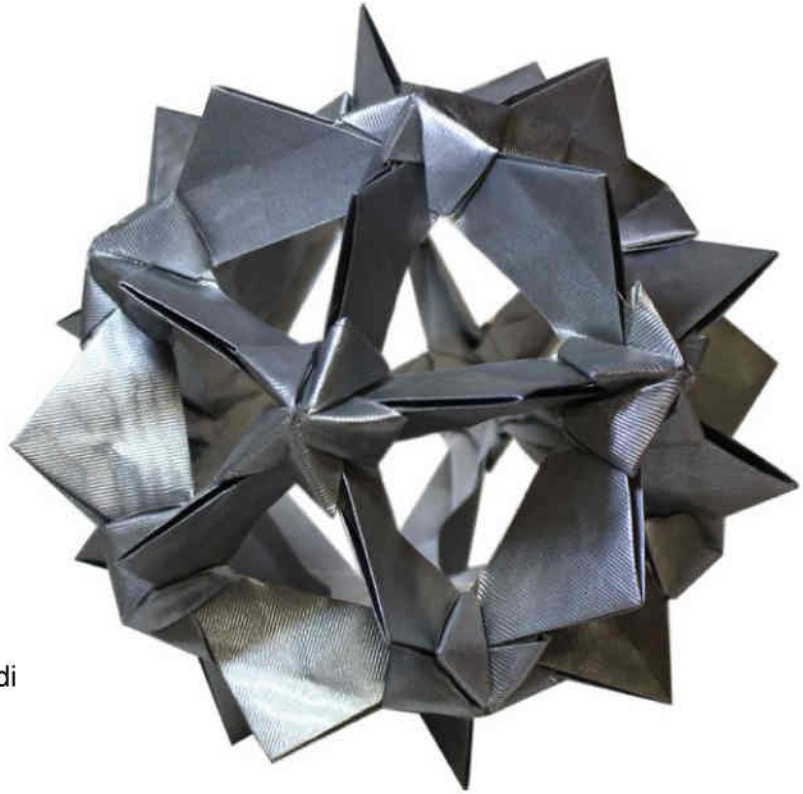

1 piega a valle

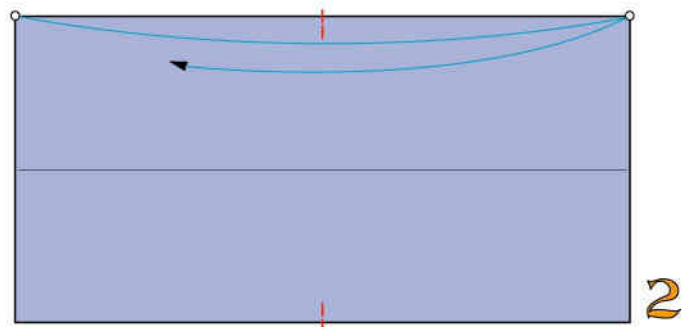

2 piccole pieghe a valle

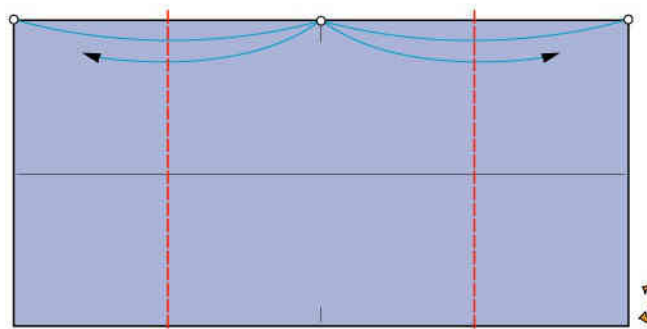

2 pieghe a valle

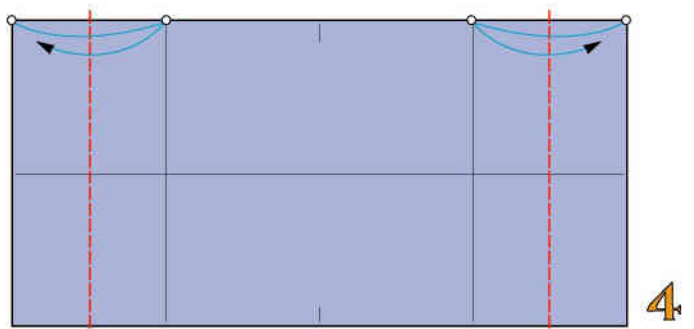

2 pieghe a valle

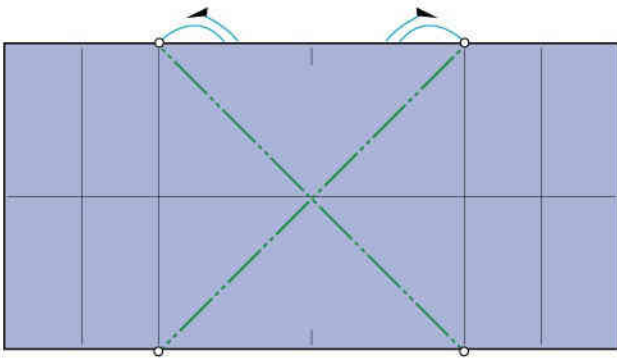

2 pieghe a monte

5

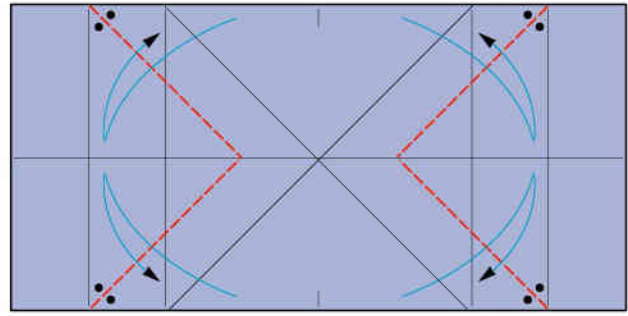

4 pieghe bisettrici a valle

6

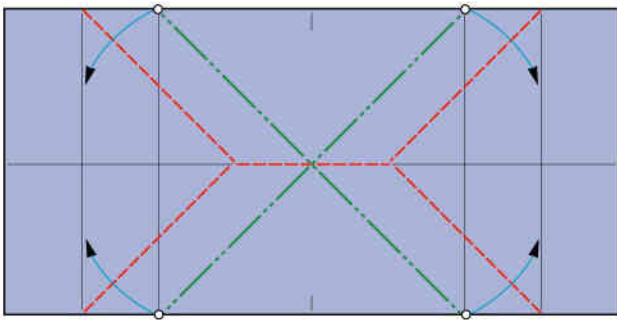

Ripiegate a valle e a monte

7

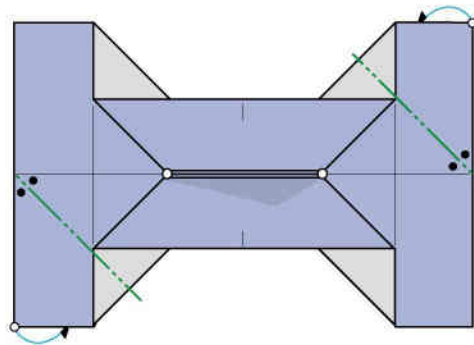

2 pieghe bisettrici a monte

8

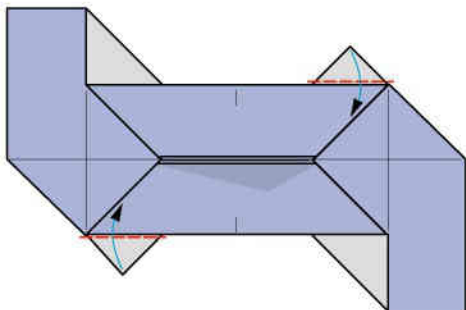

2 pieghe a valle

9

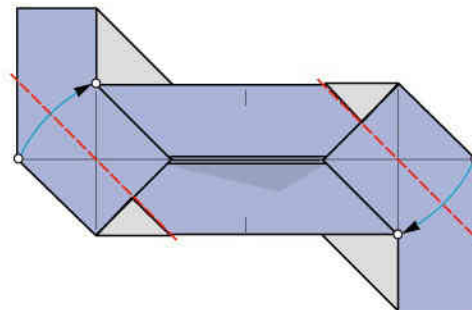

2 pieghe a valle

10

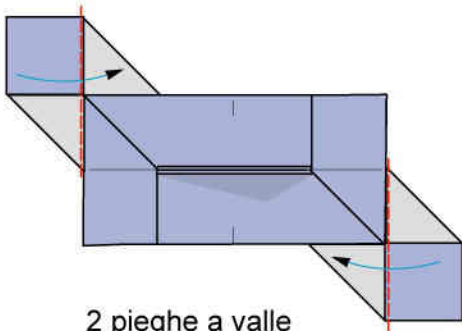

2 pieghe a valle

11

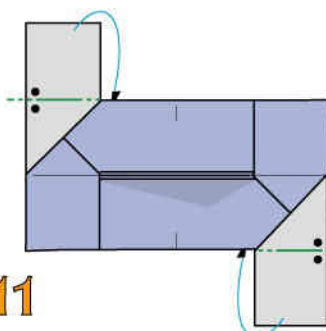

2 pieghe a monte

12

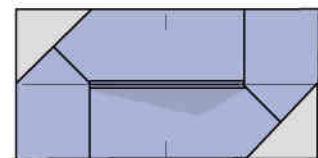

Modulo per poliedri "A" ultimato

13

UNIONE DEI MODULI

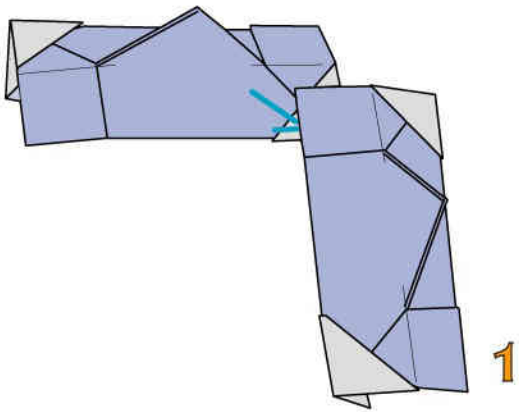

Intascate un modulo nell'altro

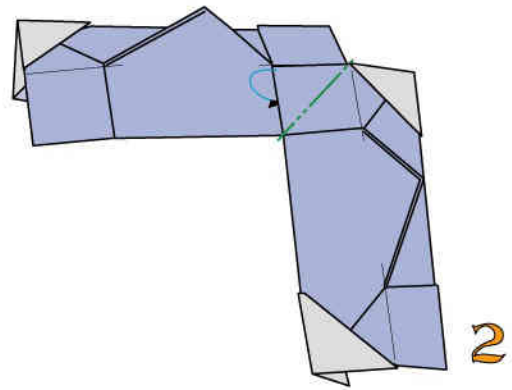

Mediante una piega a monte bloccate l'unione

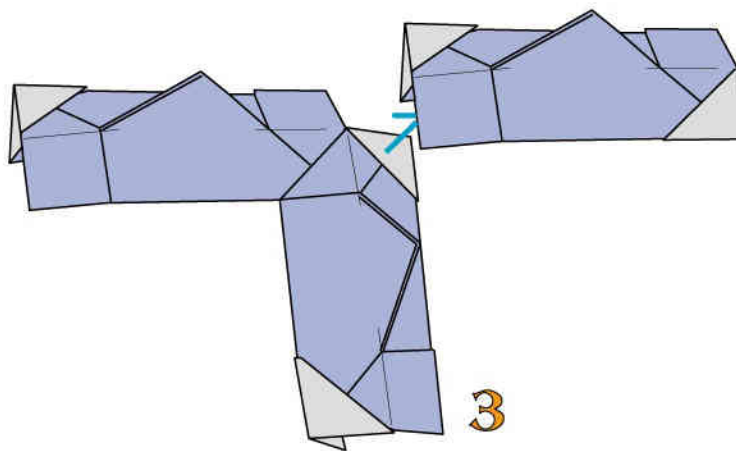

Intascate un altro modulo, che va bloccato nel solito modo.
Per la costruzione di un icosaedro si uniscono 5 moduli alla volta,
per un totale di 30 moduli.

POLIEDRO MODULARE TRAFORATO "B"

Franco Pavarin 23

Il poliedro di figura è costruito con 8 moduli composti "B1".
Ogni modulo composto è formato da 3 moduli "B", costruiti con fogli quadrati di carta da 120 gr. delle dimensioni di cm 7,5 di lato

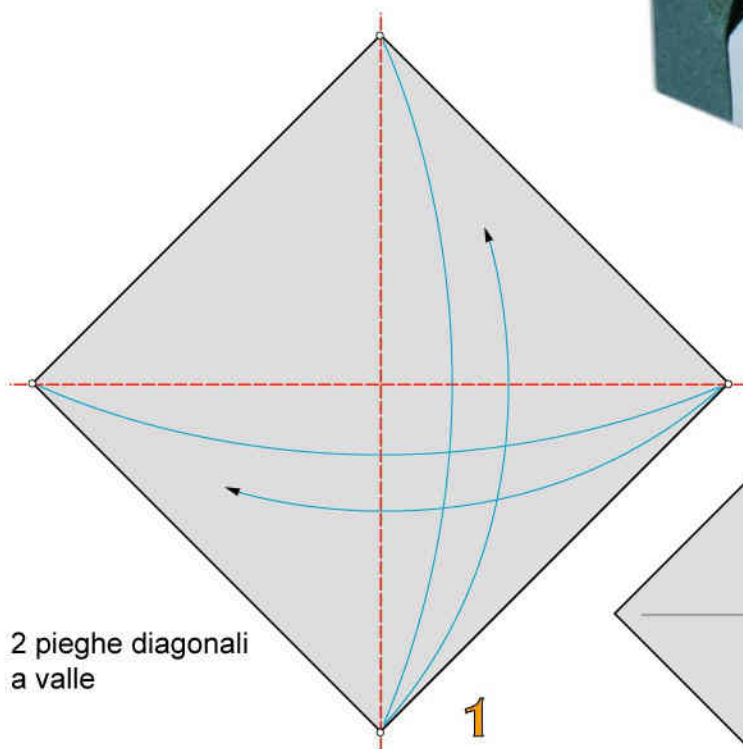
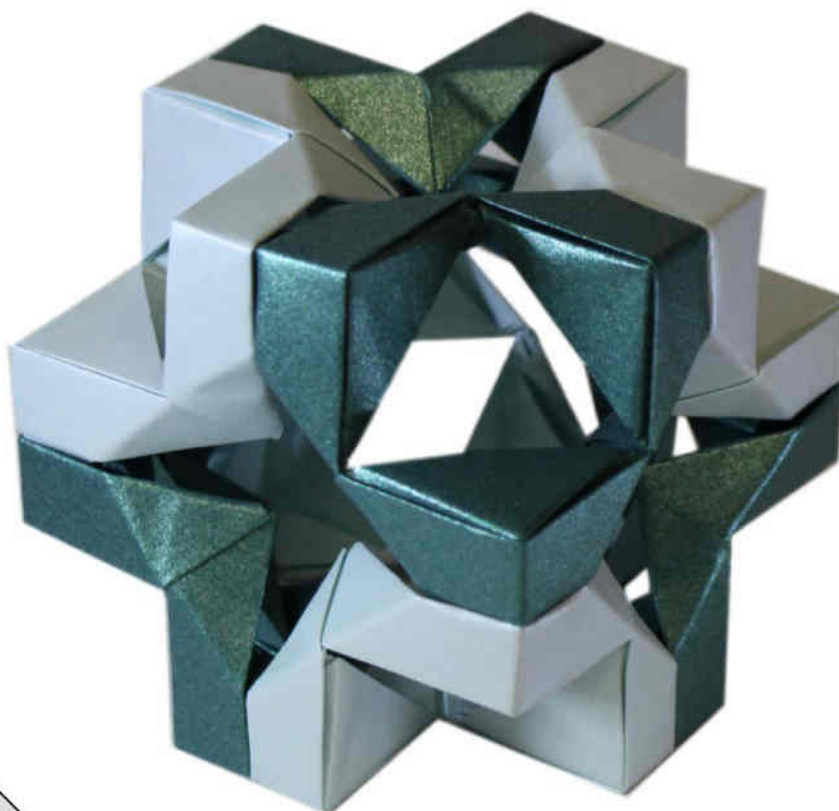

2 pieghe diagonali
a valle

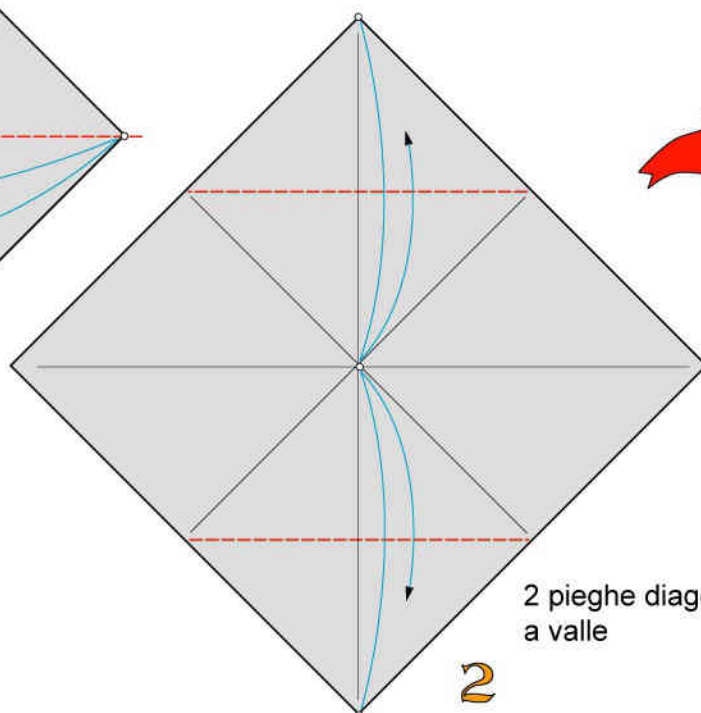

2 pieghe diagonali
a valle

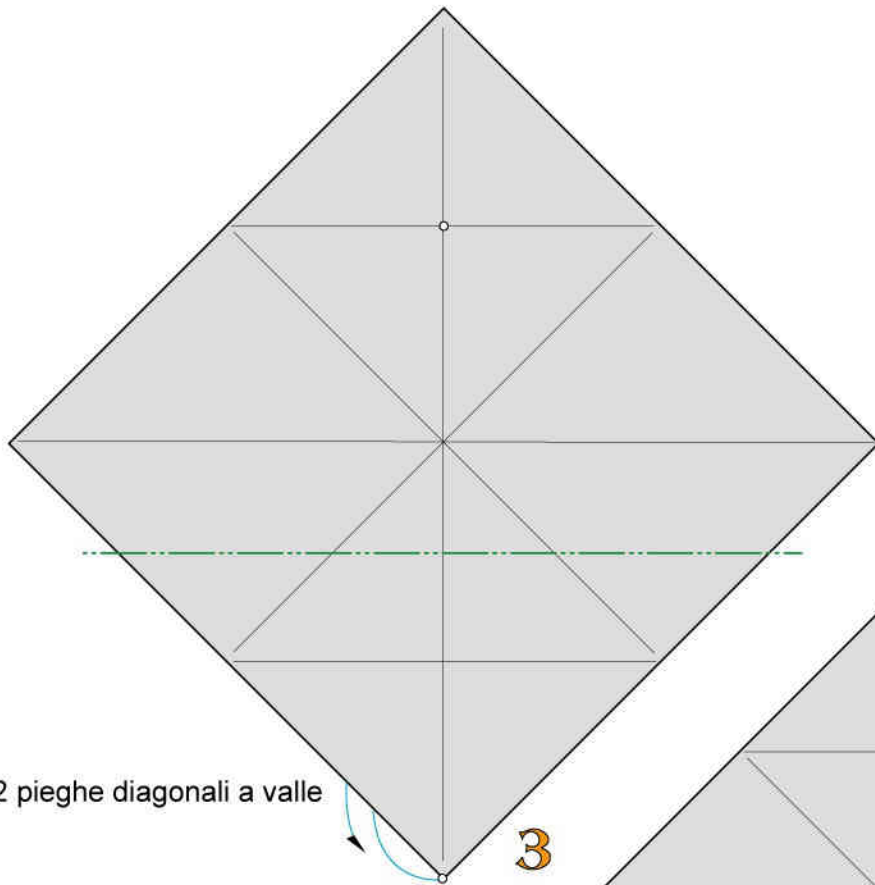

2 pieghe diagonali a valle

3

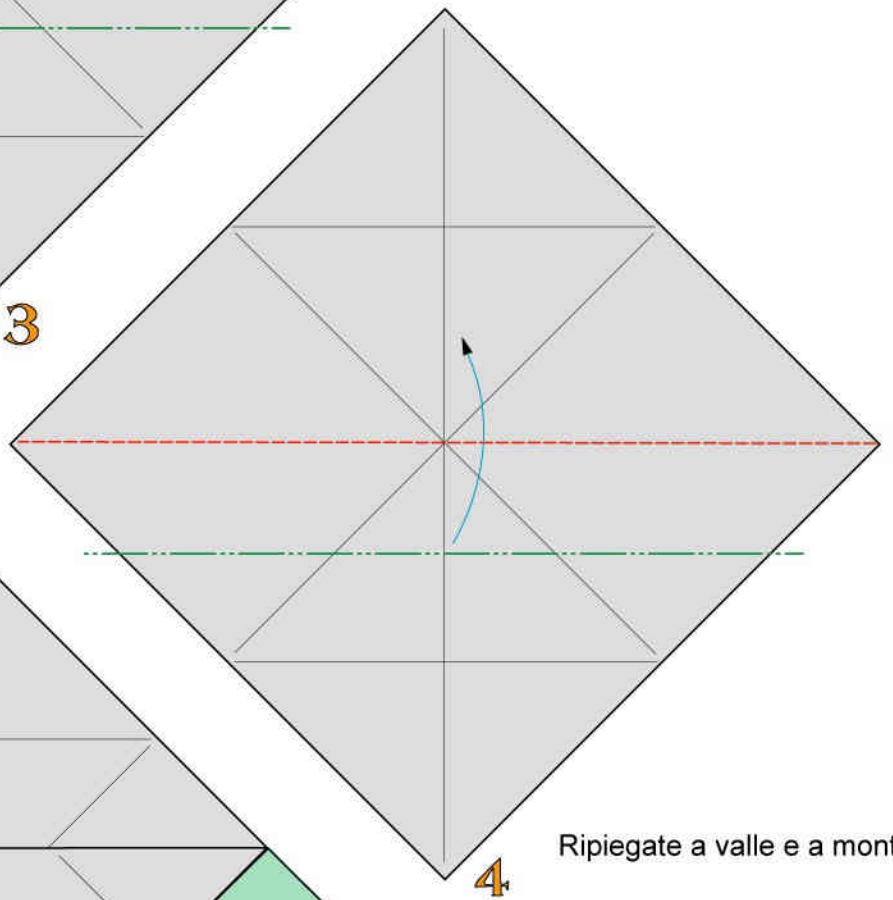

Ripiegate a valle e a monte

4

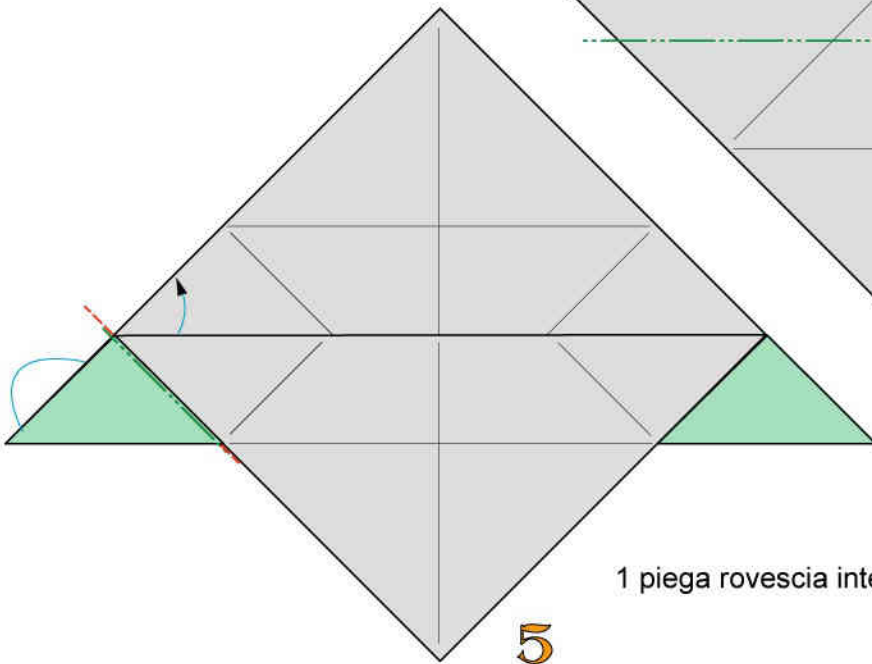

1 piega rovescia interna

5

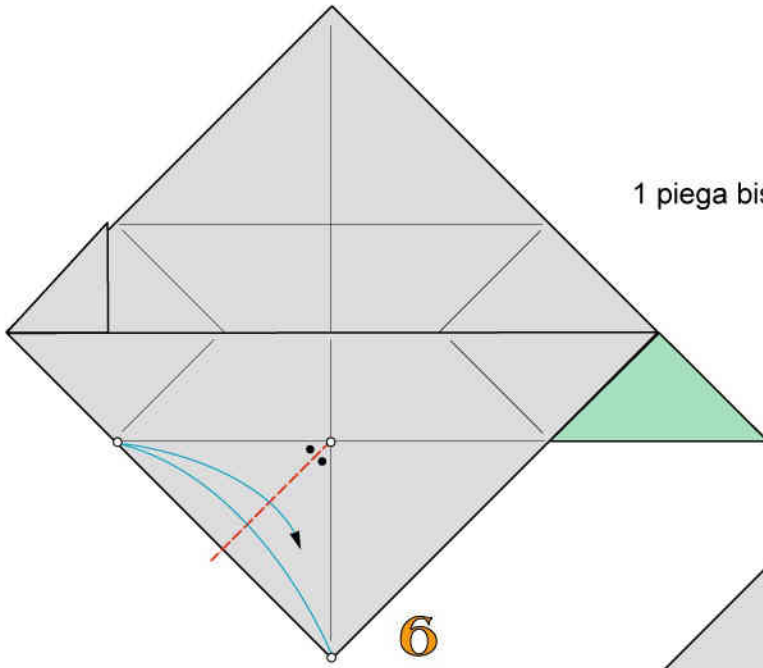

1 piega bisettrice a valle

6

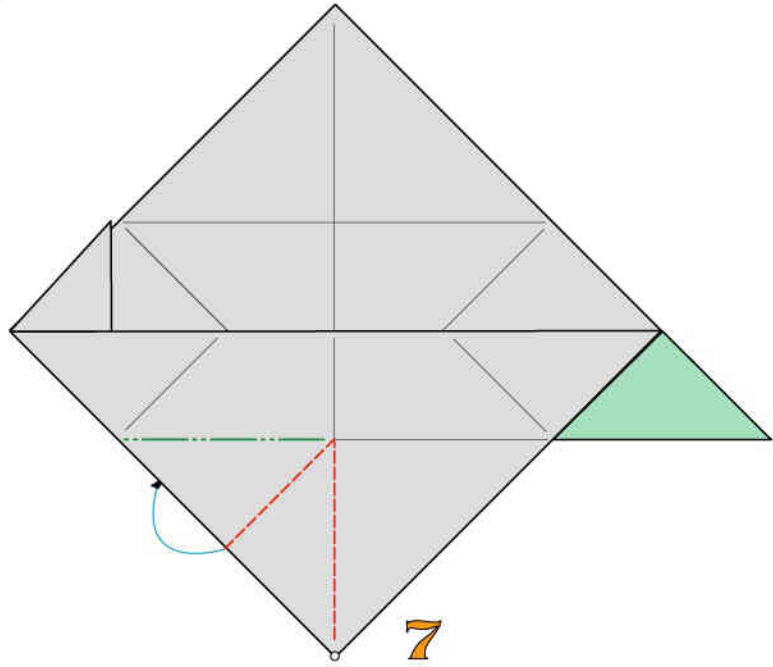

7

Ripiegando a valle e a monte modellate 3D

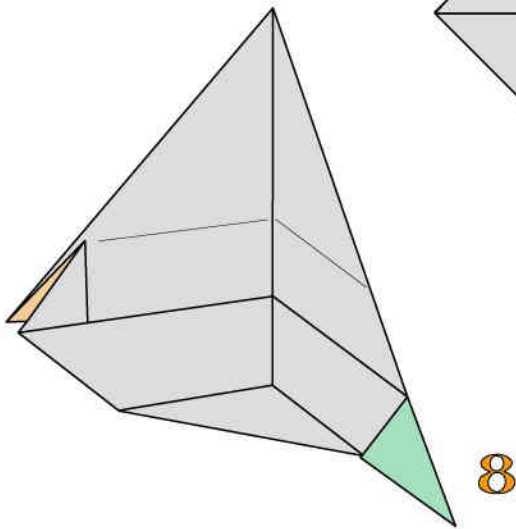

8

Modulo per poliedri "B" ultimato

UNIONE DI 3 MODULI SEMPLICI "B" PER FORMARE UN MODULO COMPOSTO "B"

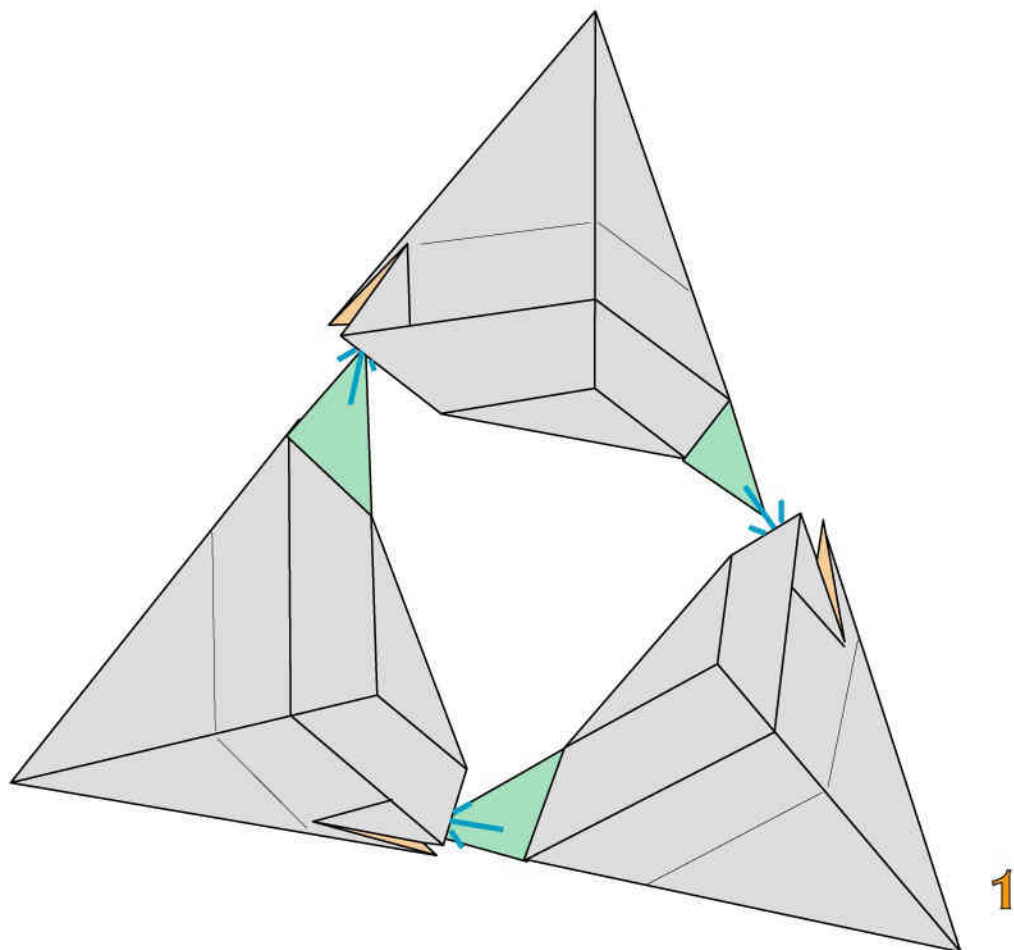

Intascate i moduli in successione

Mediante 3 pieghe a monte bloccate l'unione

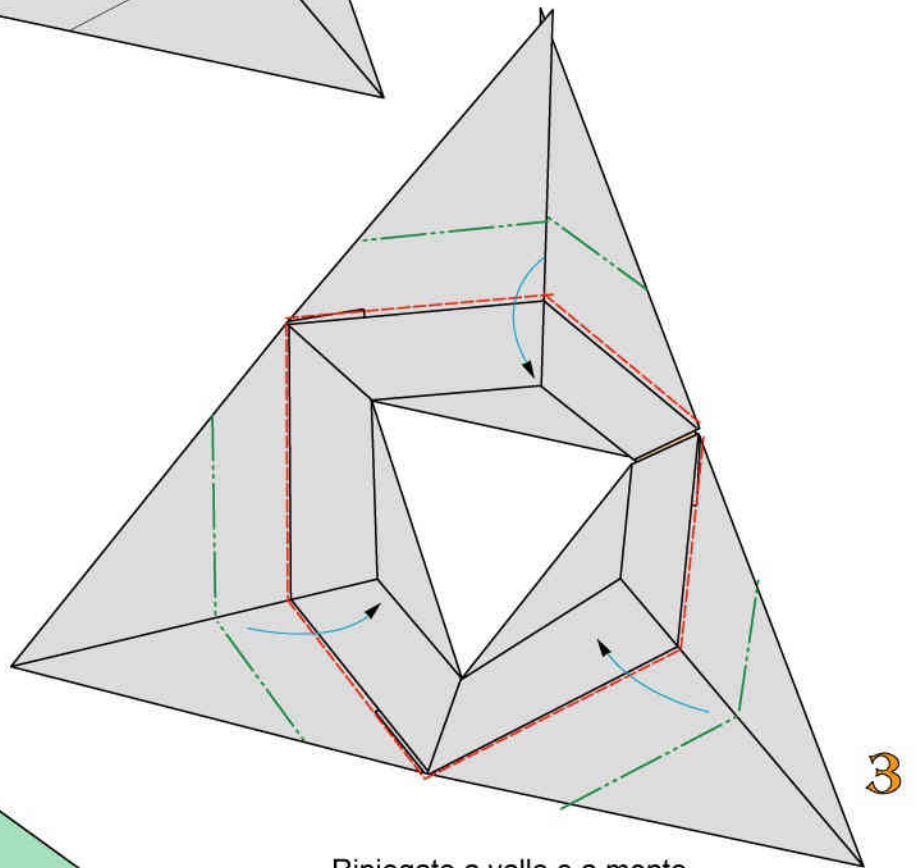
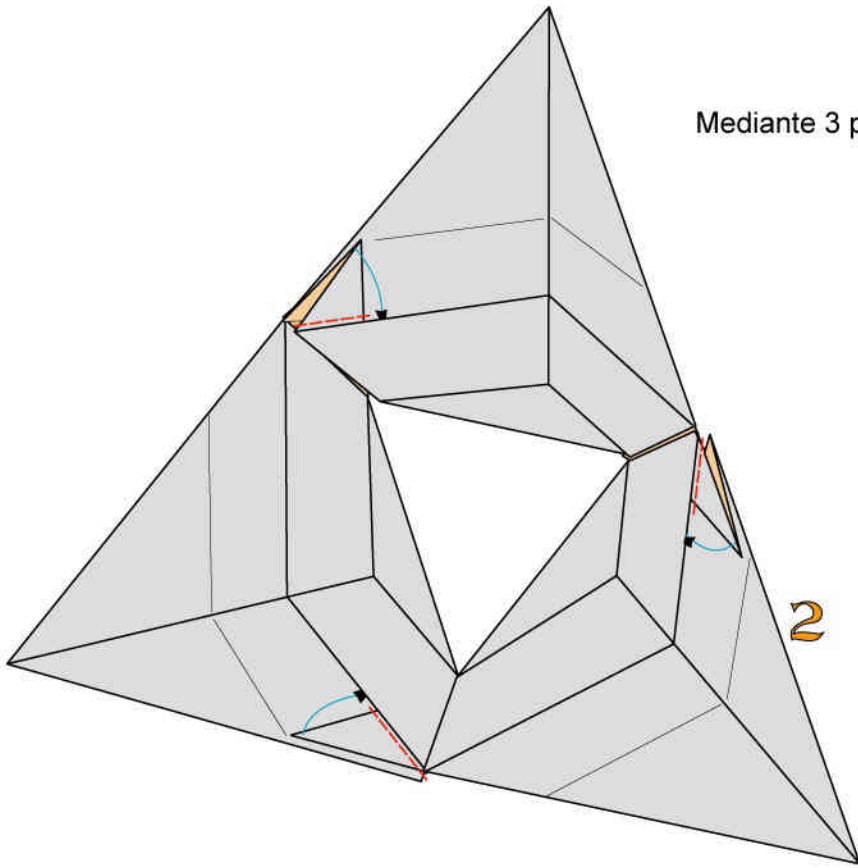

Ripiegate a valle e a monte

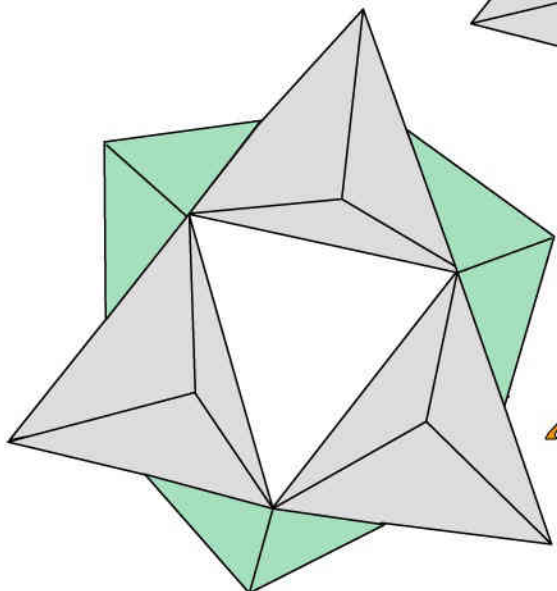

Modulo composto "B" ultimato. Ribaltate

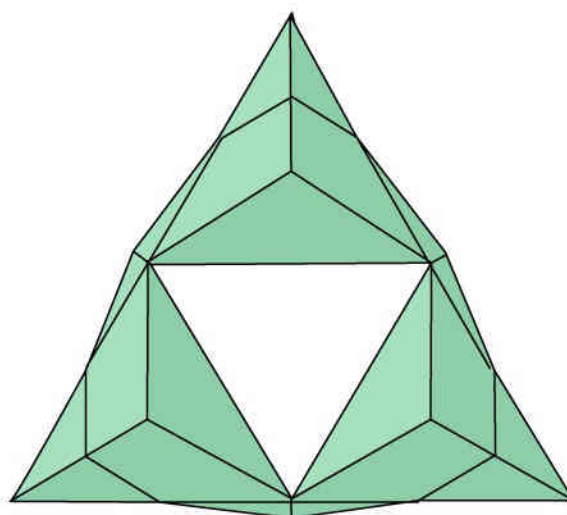
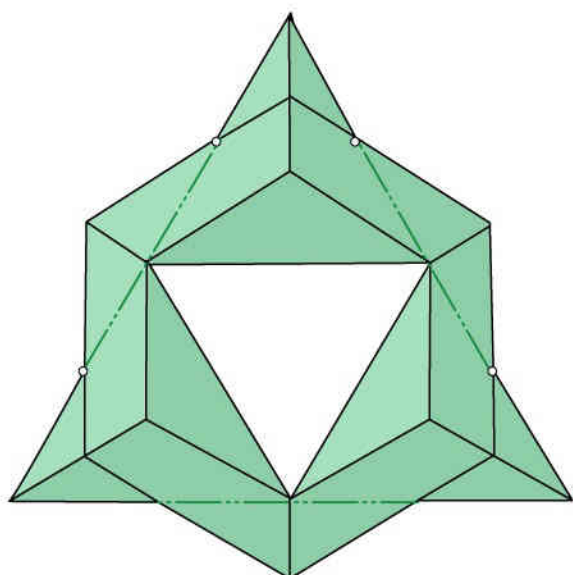

3 pieghe a monte per realizzare il modulo composto "B1"

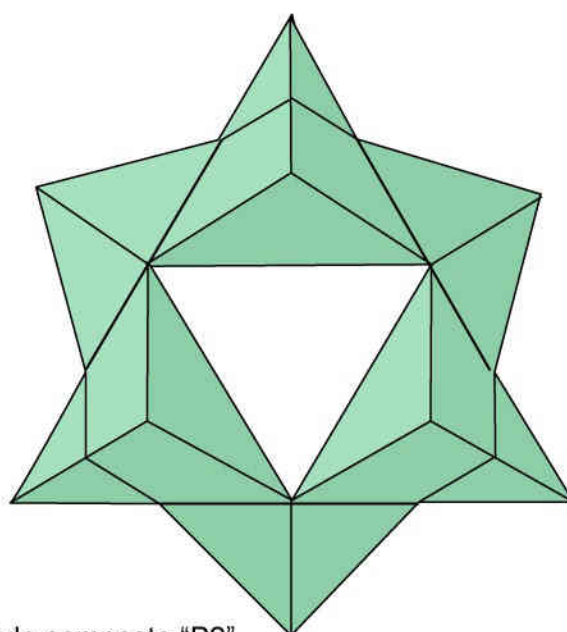
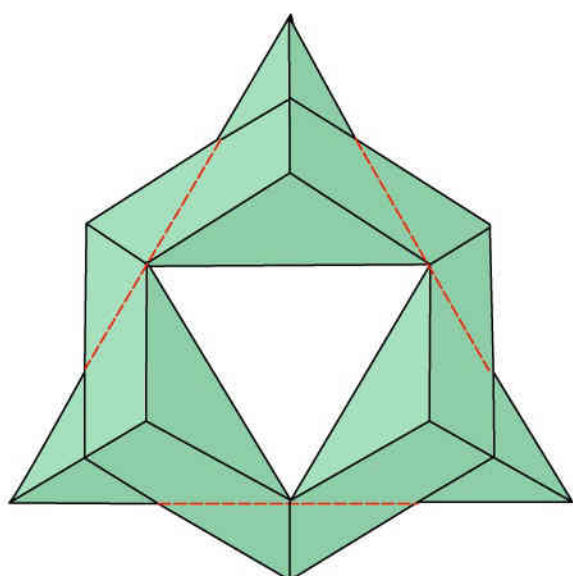

3 pieghe a valle per realizzare il modulo composto "B2"

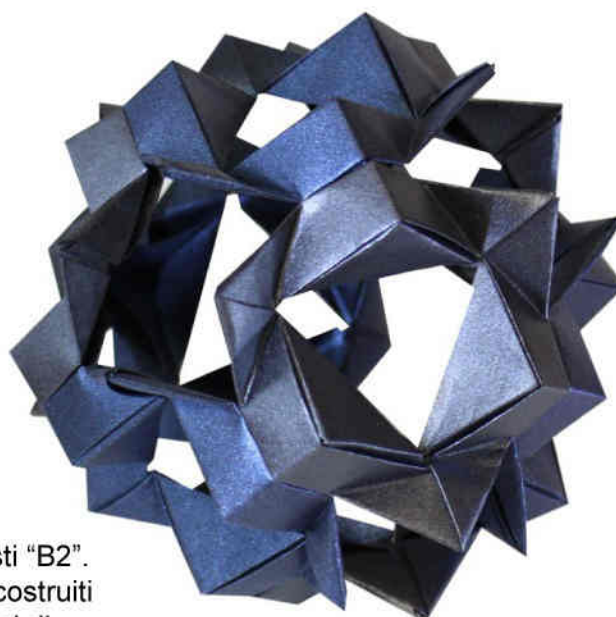

Il poliedro di figura è costruito con 8 moduli composti "B2".
 Ogni modulo composto è formato da 3 moduli "B", costruiti
 con fogli quadrati di carta da 120 gr. delle dimensioni di
 cm 7,5 di lato

POLIEDRO MODULARE TRAFORATO "C"

Franco Pavarin 23

Semplice la costruzione dei moduli,
complesso il montaggio.

Il poliedro di figura è costruito con moduli composti "C".
Ogni modulo composto è formato da 6 moduli semplici "C",
costruiti con fogli quadrati di carta monocolora da 120 gr.
delle dimensioni di cm 7,5 di lato, per un totale di 60 fogli

The polyhedron in the figure is constructed with composite
"C" modules. Each composite module is made up of 6
simple "C" modules, constructed with square sheets of 120
single-color paper measuring 7,5 cm on each side, for a
total of 60 sheets

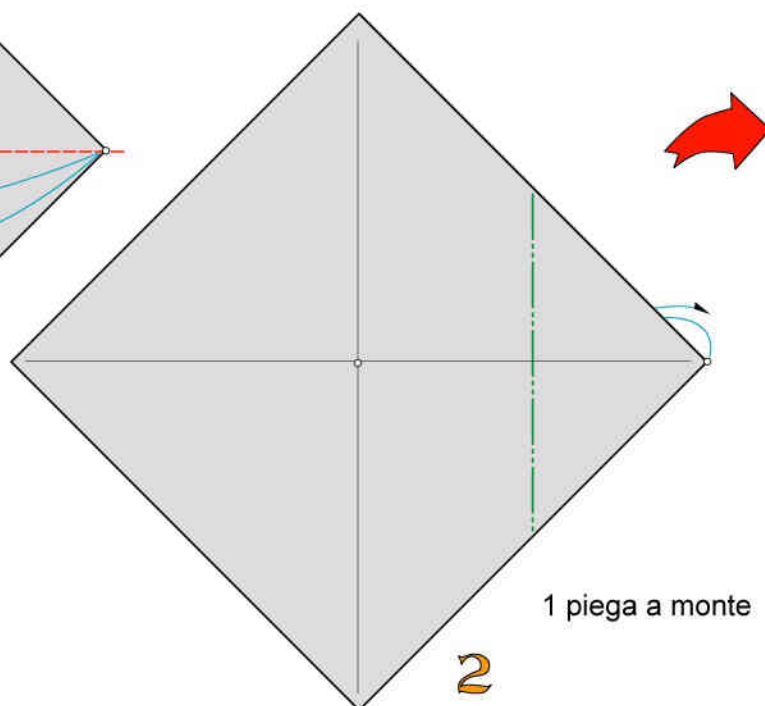
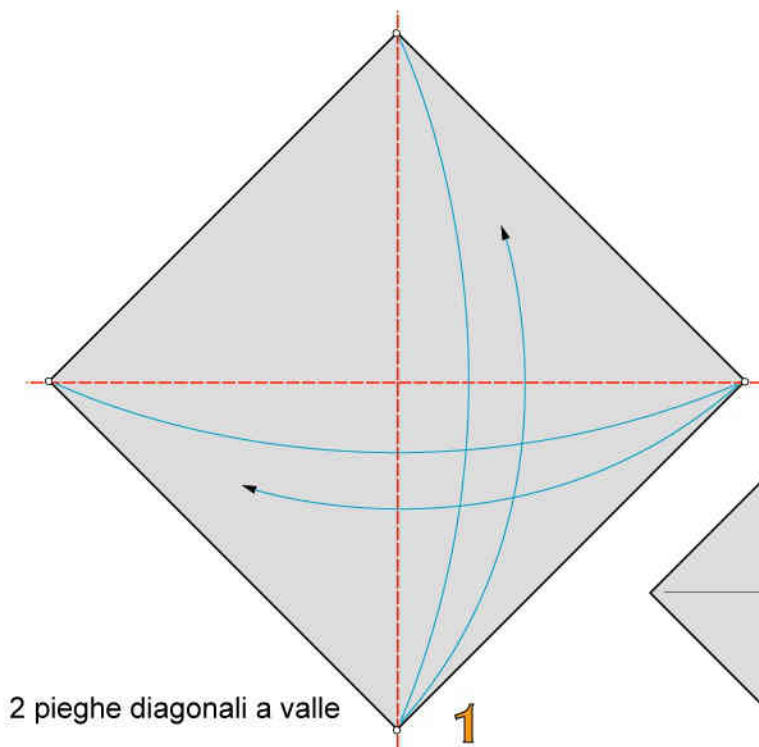

1 piega a monte

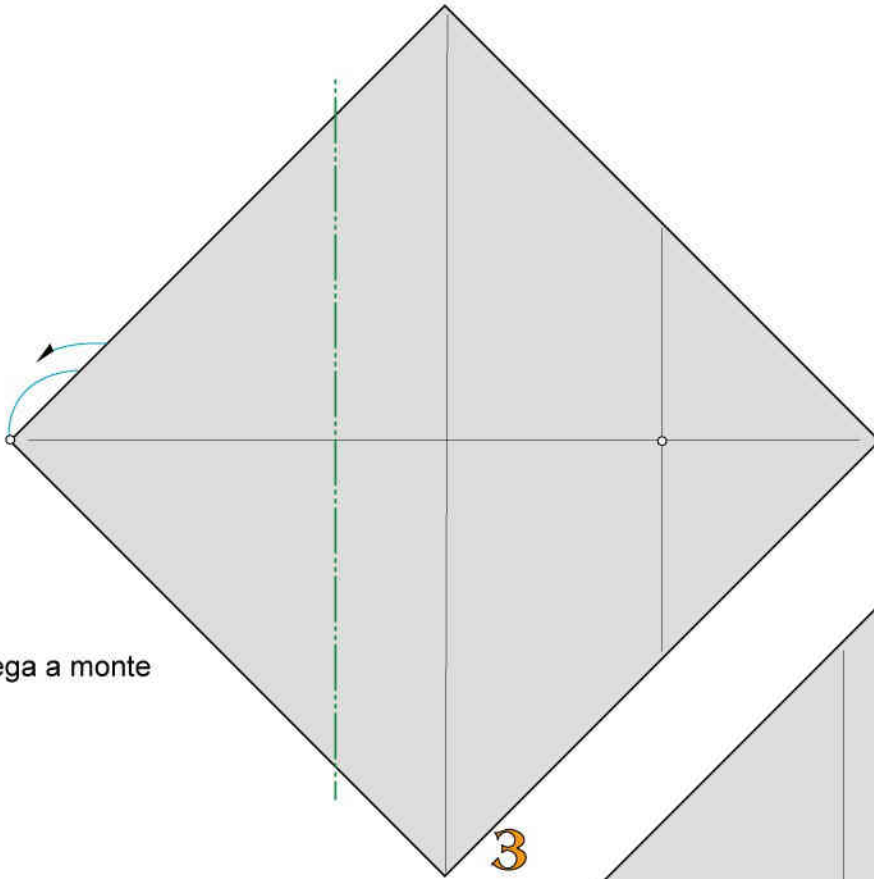

3

1 piega a valle e ripiegate a monte

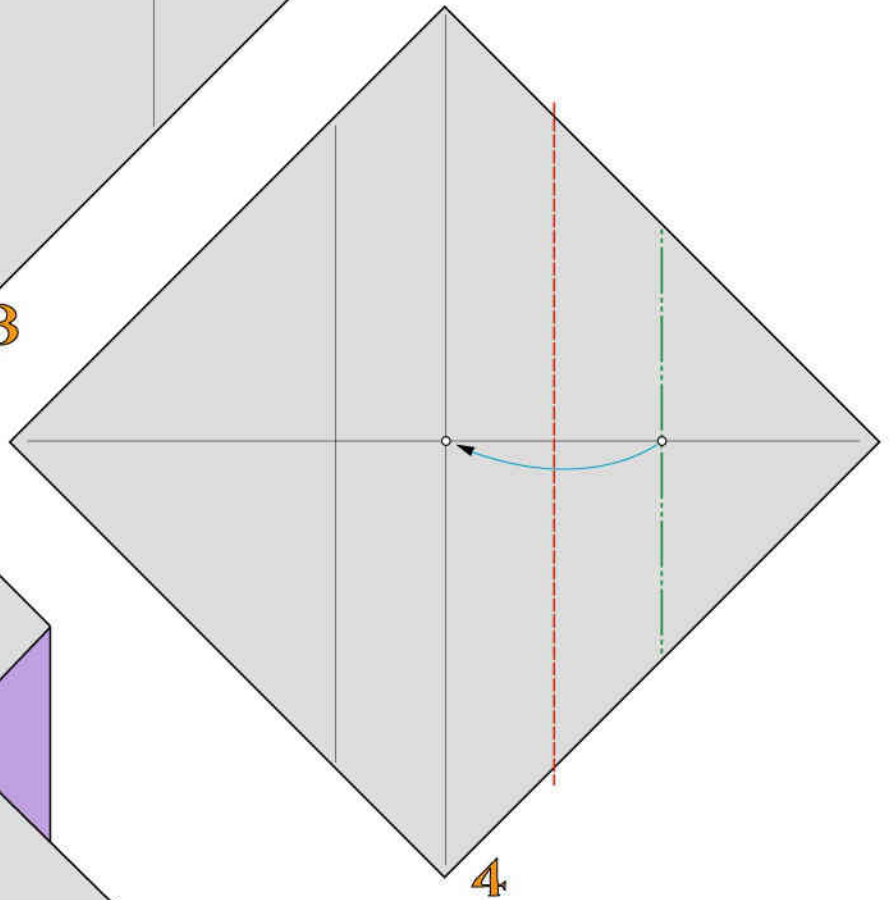

4

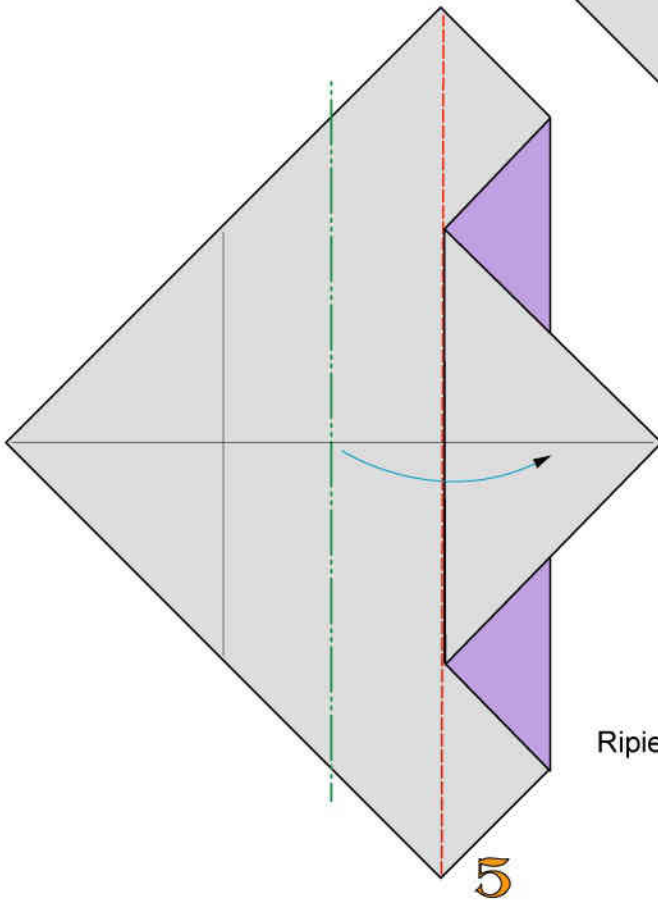

5

Ripiegate a valle e a monte

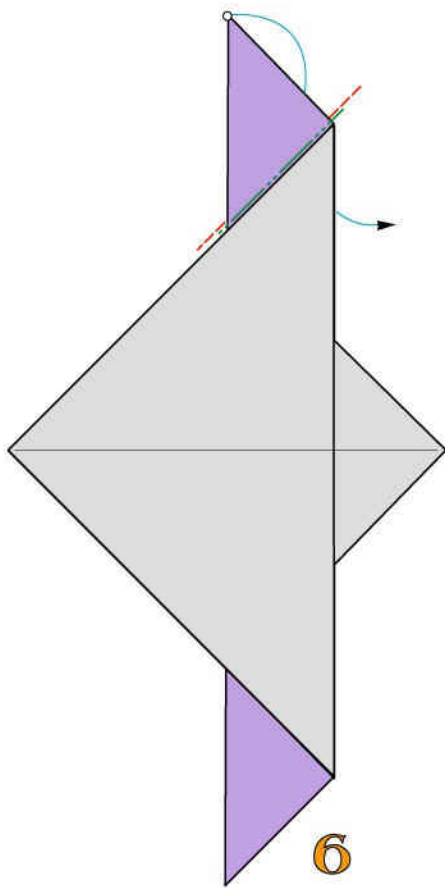

6

1 piega rovescia interna

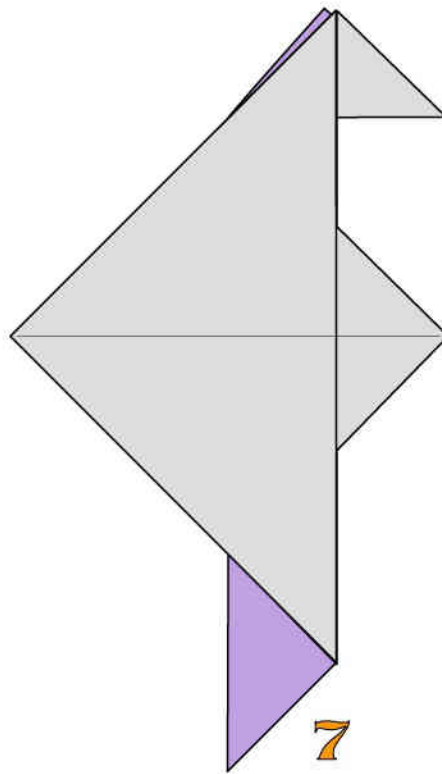

7

Modulo semplice "C" ultimato

UNIONE DI 2 MODULI SEMPLICI "C"

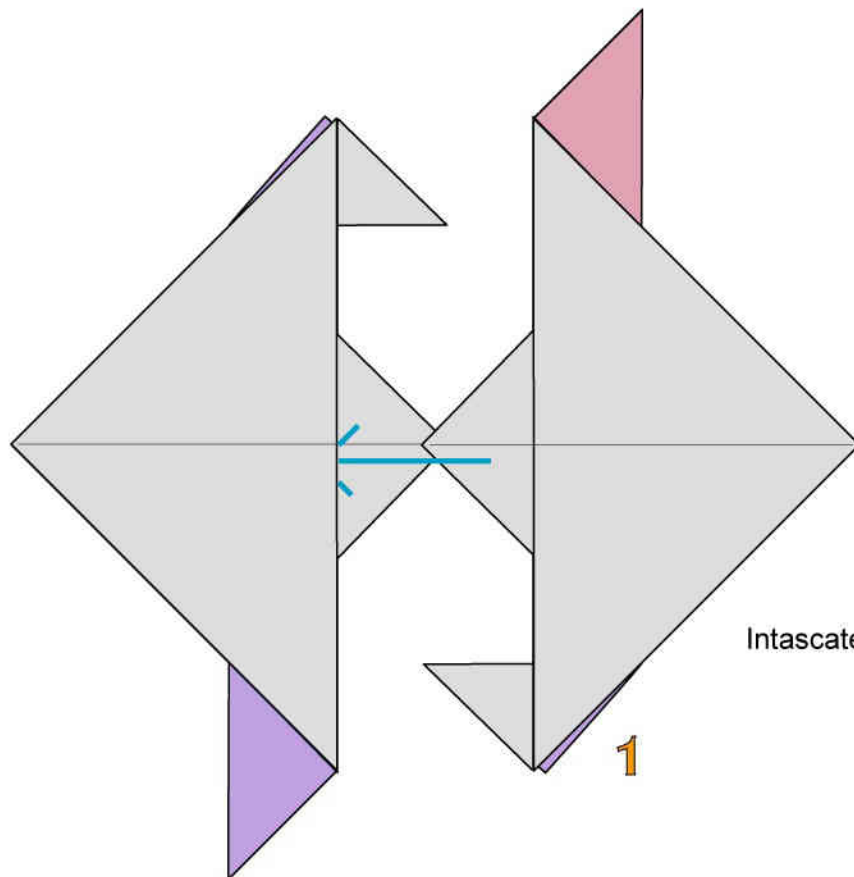

Intascate 1 modulo nell'altro

1

Modulo composto "C" ultimato.
Ribaltate

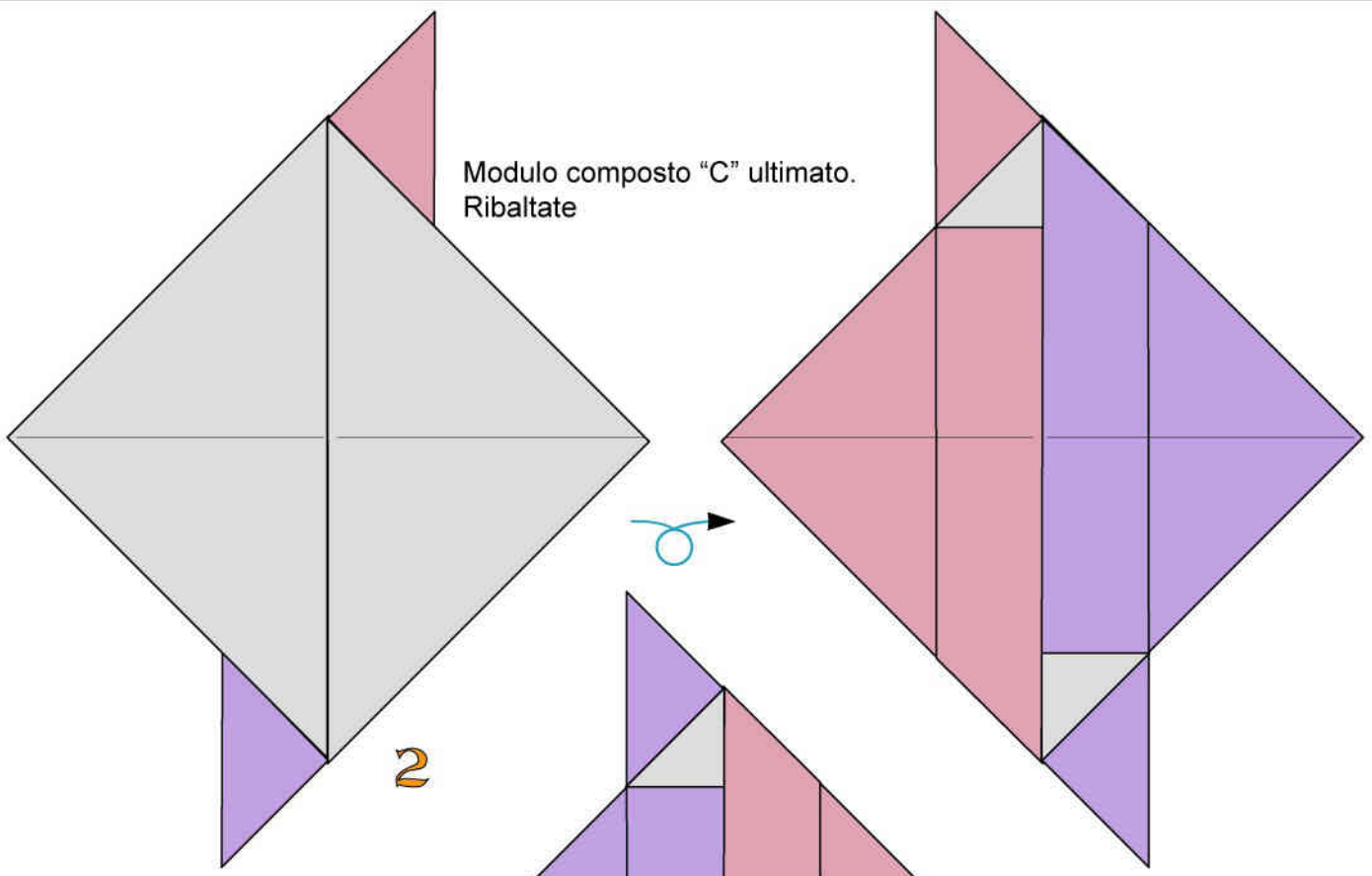

2

UNIONE DI 3 MODULI COMPOSTI

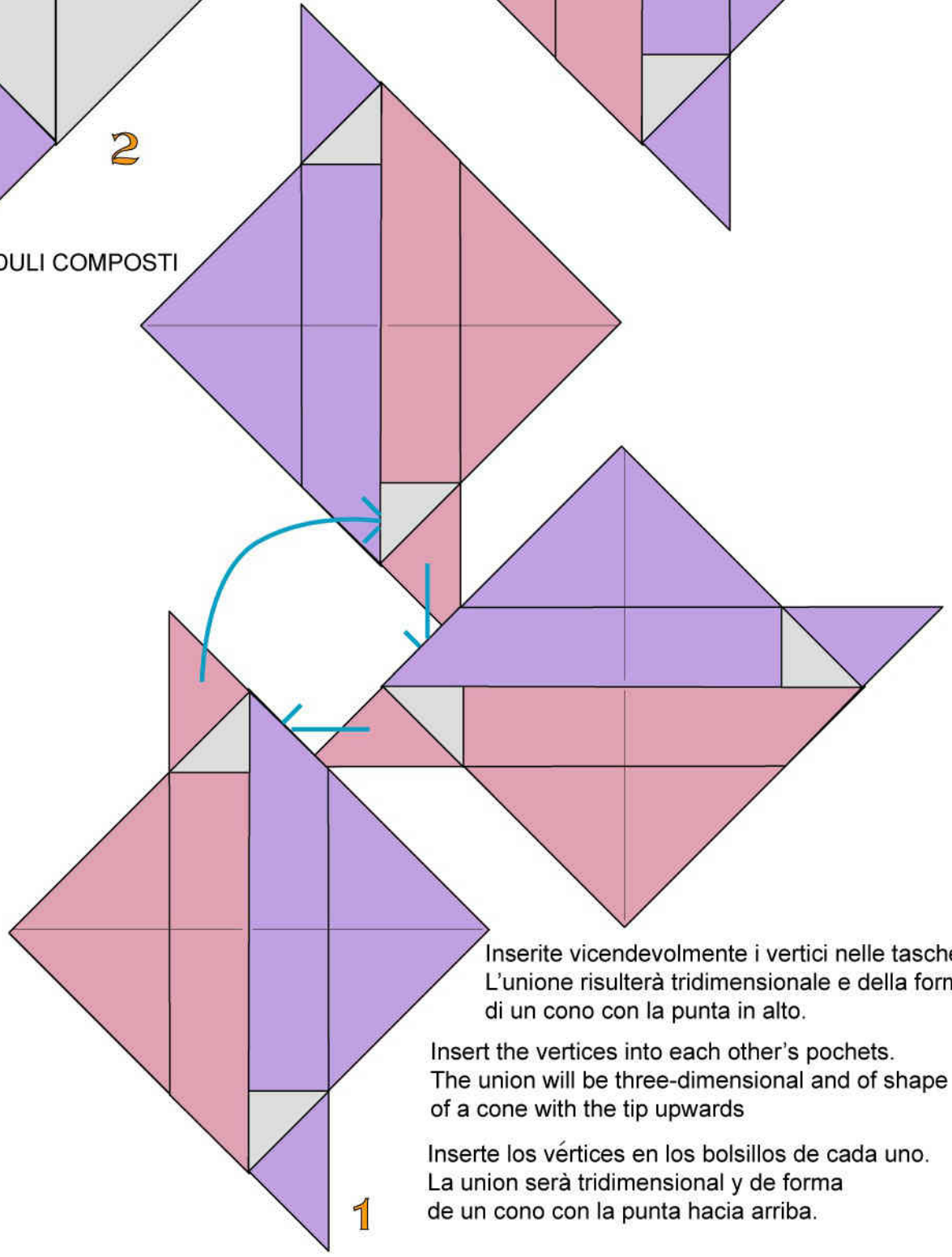

Inserite vicendevolmente i vertici nelle tasche.
L'unione risulterà tridimensionale e della forma
di un cono con la punta in alto.

Insert the vertices into each other's pockets.
The union will be three-dimensional and of shape
of a cone with the tip upwards

Inserte los vértices en los bolsillos de cada uno.
La union será tridimensional y de forma
de un cono con la punta hacia arriba.

1

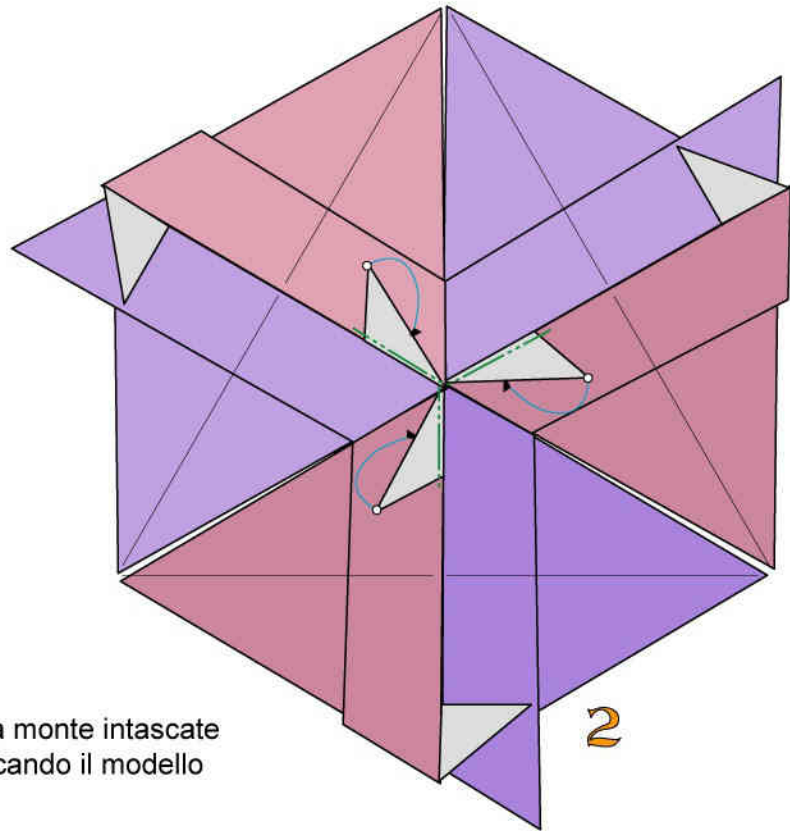

Mediante 4 pieghe a monte intascate i vertici indicati bloccando il modello

2

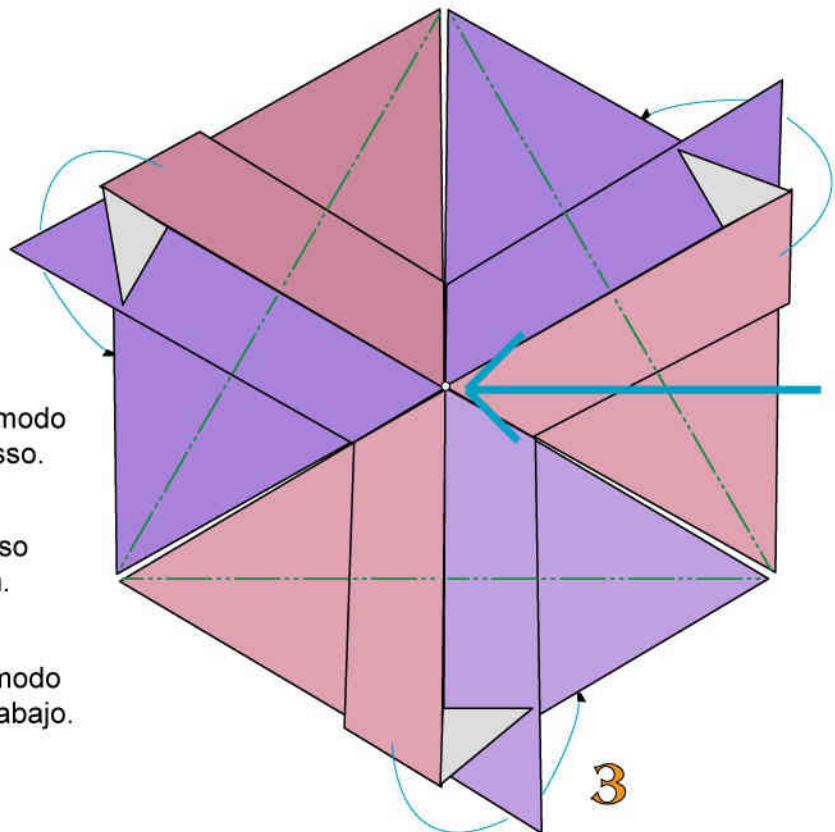

Comprimete il centro del cono in modo che il vertice vada a finire in basso. Ripiegate 3 volte a monte.

Compress the center of the cone so that the top ends up at the bottom. Fold 3 times upstream.

Comprime el centro del cono de modo que lo de arriba termine en lo de abajo. Doblar 3 veces hacia arriba.

3

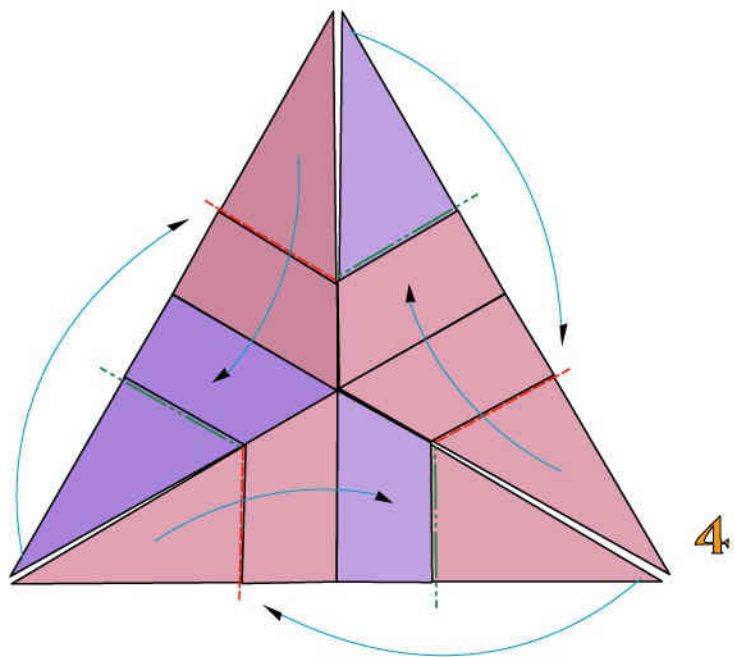

3 pieghe a valle e 3 a monte

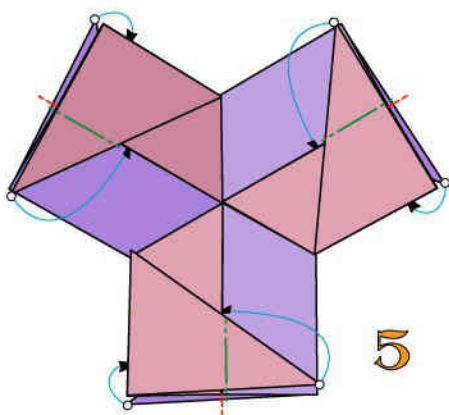

Intascate superiormente e inferiormente

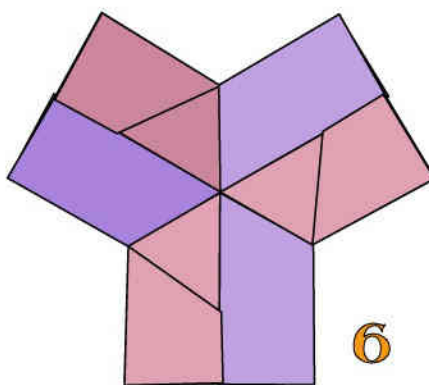

6 moduli semplici uniti.
Procedete nello stesso modo per i rimanenti.

POLIEDRO MODULARE TRAFORATO "D"

Franco Pavarin 23

Si tratta di un icosaedro, poligono regolare con 20 facce a triangolo equilatero.
Si costruisce con 30 moduli da realizzare con carta bicolore di medio peso e delle dimensioni di cm 7,5x7,5.

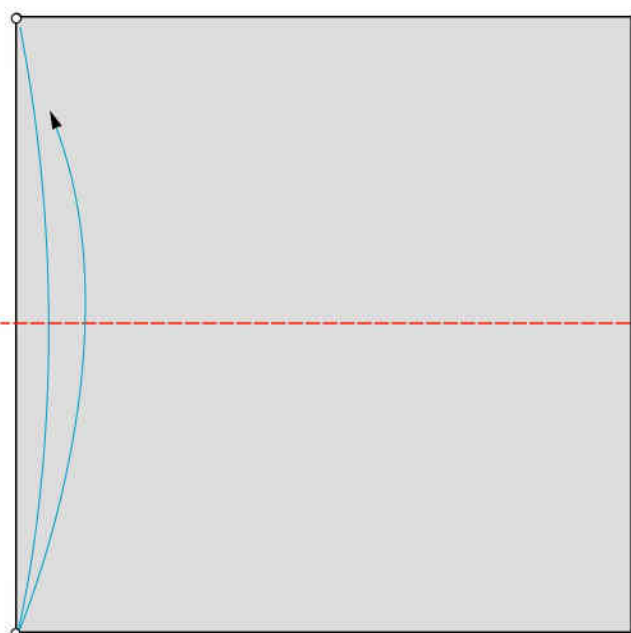
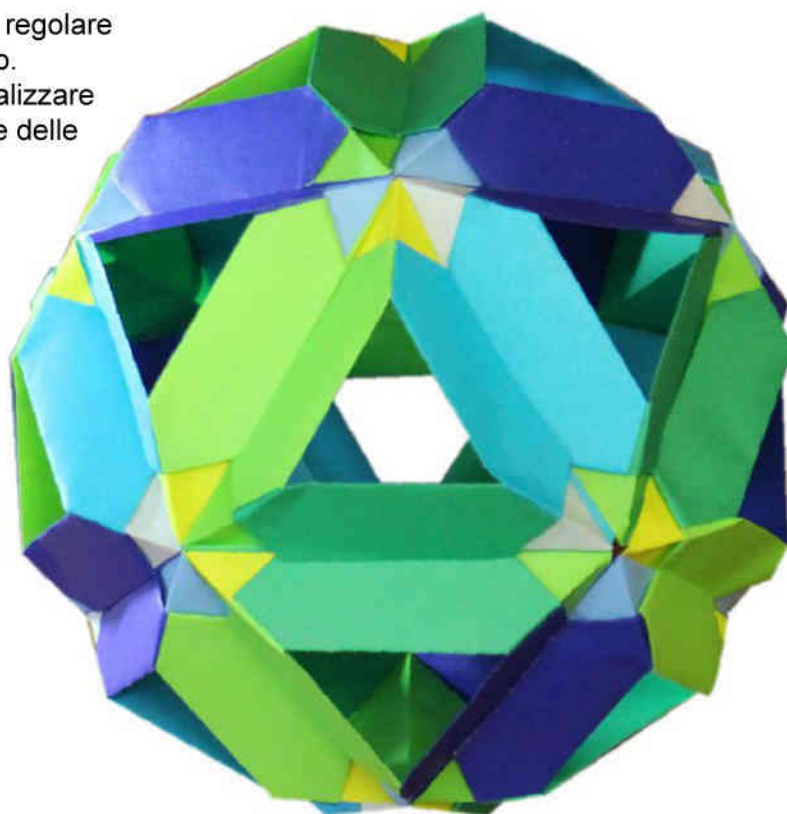

1 piega a valle

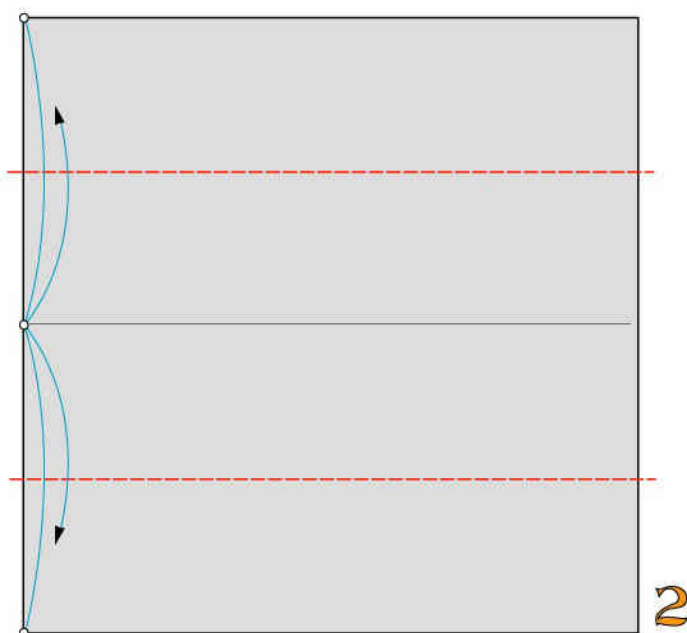

2 pieghe a valle

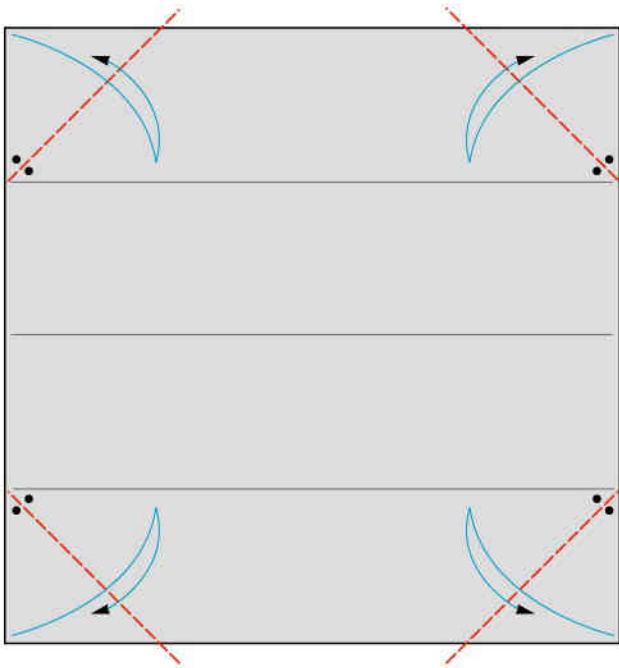

3

4 pieghe bisettrici a valle

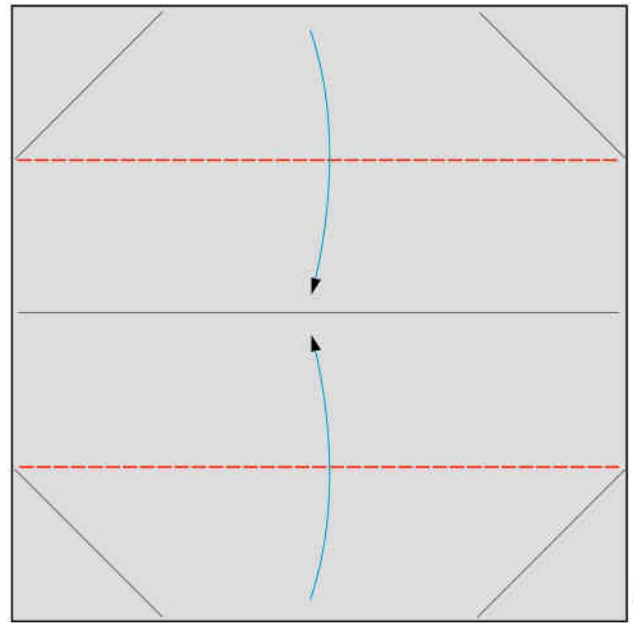

4

Ripiegate a valle

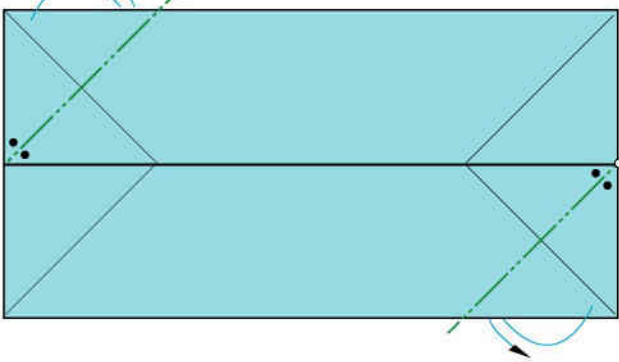

5

2 pieghe bisettrici a monte

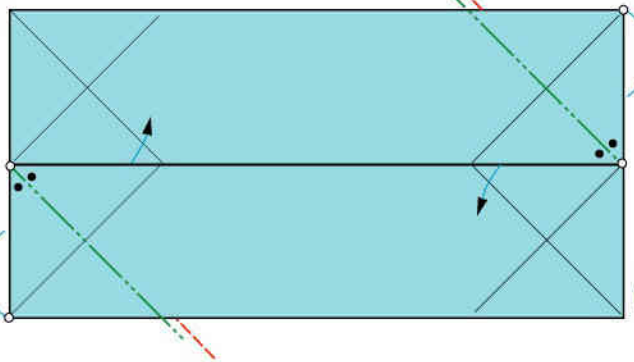

6

2 pieghe rovesce interne

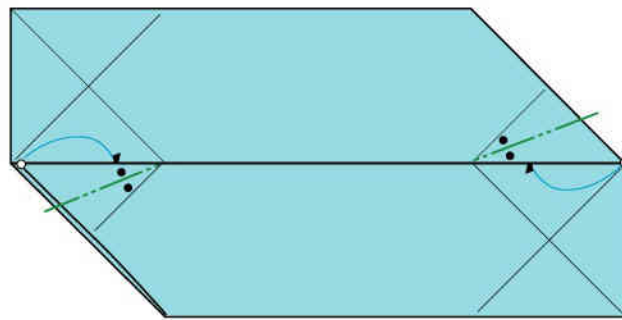

7

2 pieghe bisettrici a monte

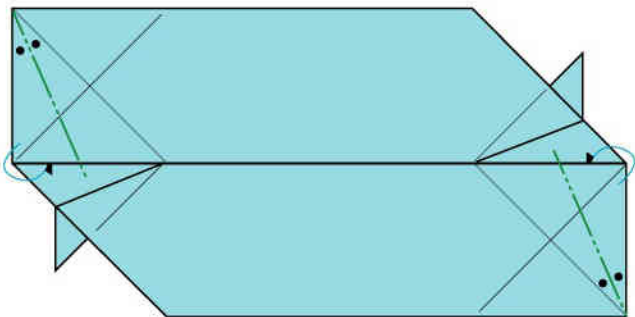

8

2 pieghe bisettrici a monte

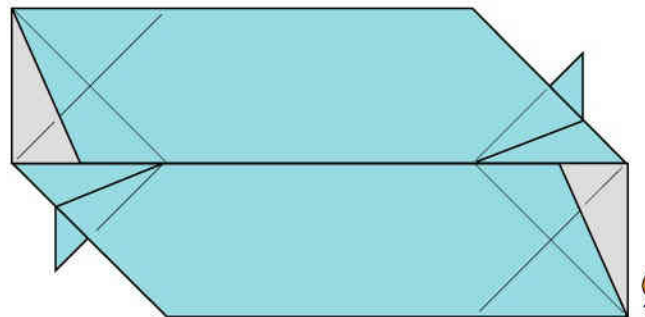

9

Modulo per poliedri "D" ultimato

UNIONE DEI MODULI

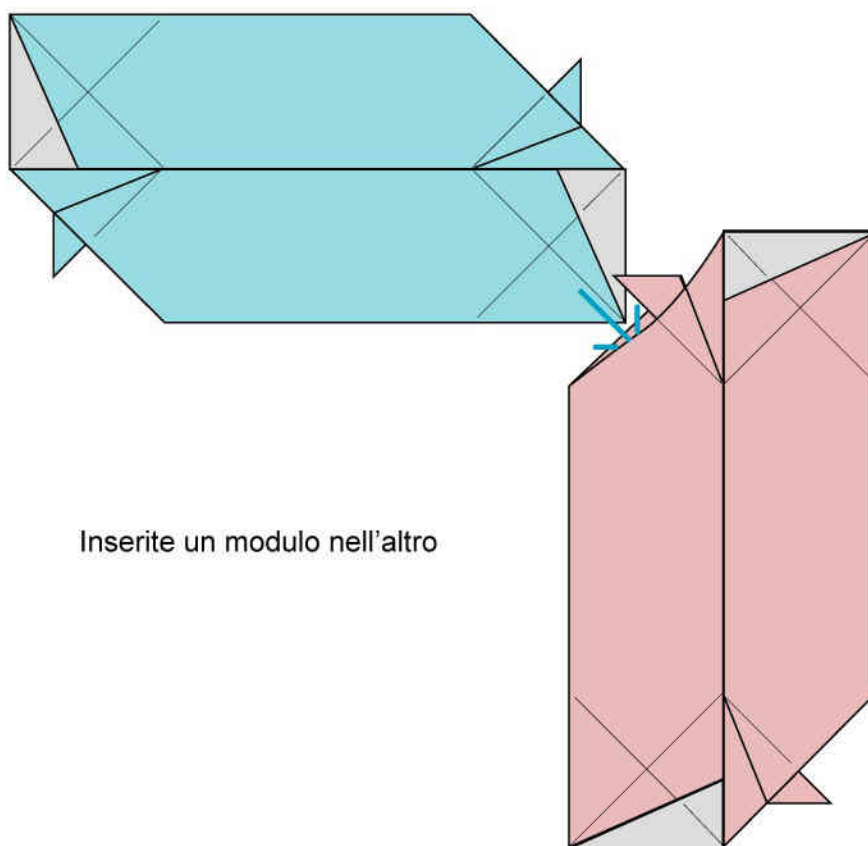

Inserite un modulo nell'altro

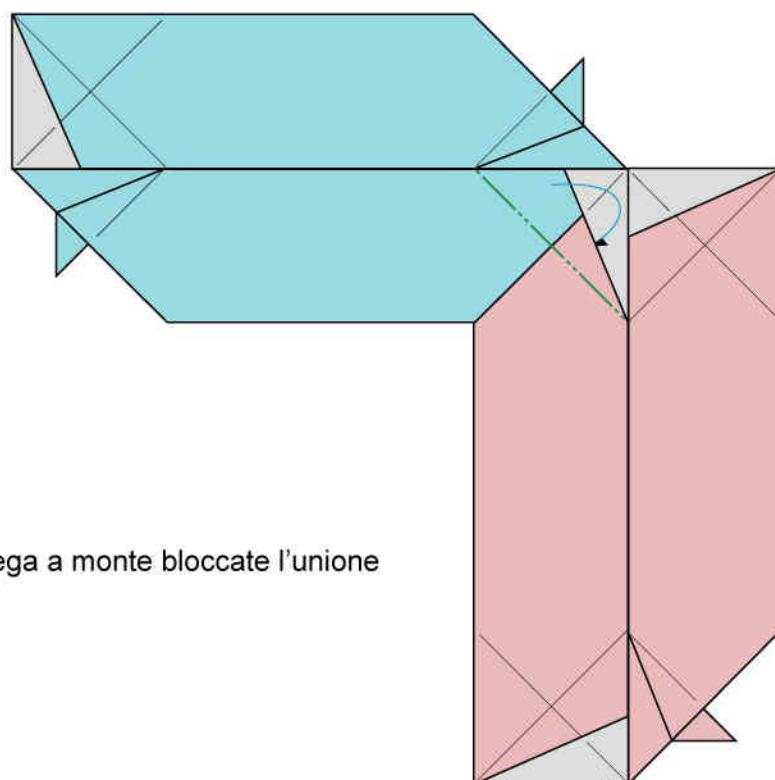

Mediante 1 piega a monte bloccate l'unione

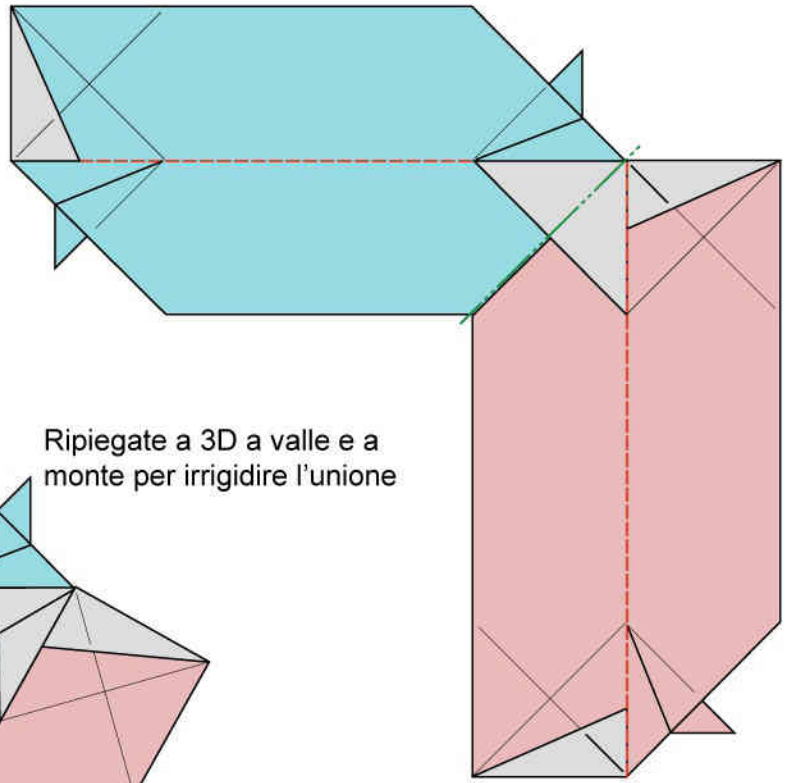

Ripiegate a 3D a valle e a monte per irrigidire l'unione

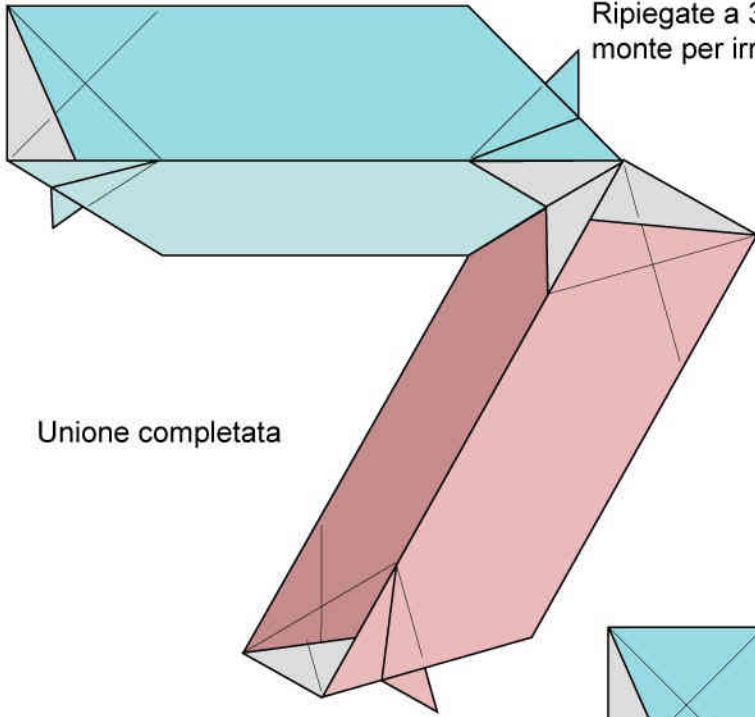

Unione completata

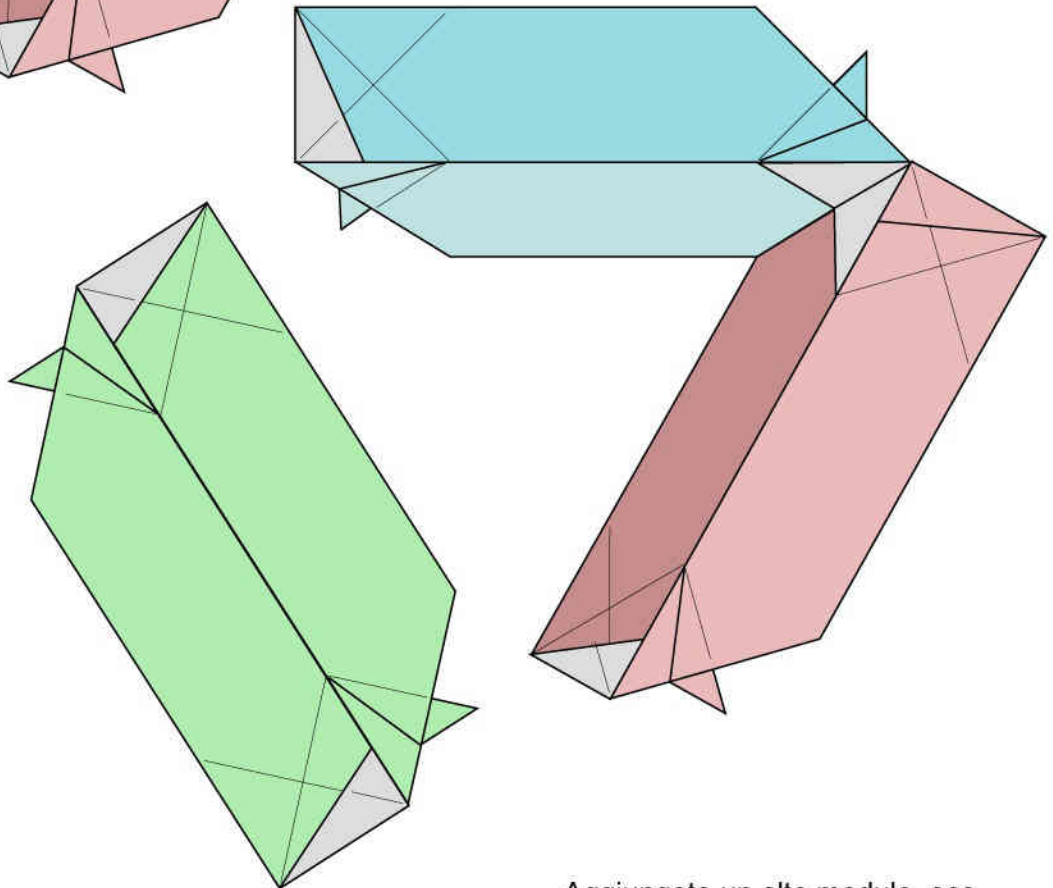

Aggiungete un altro modulo, ecc.

POLIEDRO MODULARE TRAFORATO "E"

Franco Pavarin 23

Evoluzione del modello precedente dal quale riprende lo schema costruttivo, necessita però di 30 fogli bicolore rettangolari delle dimensioni di cm 7,5x15 di carta di medio peso

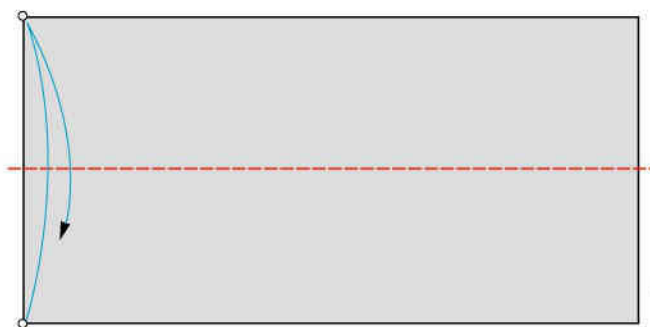

1 piega a valle

1

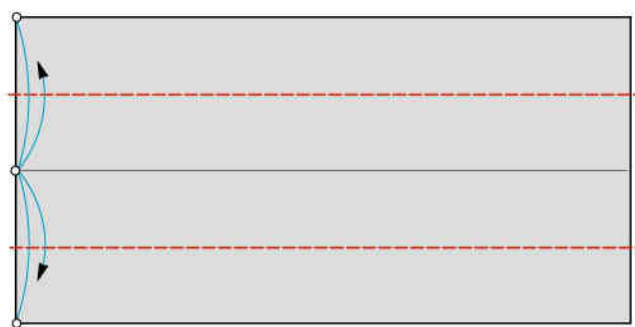

2 pieghe a valle

2

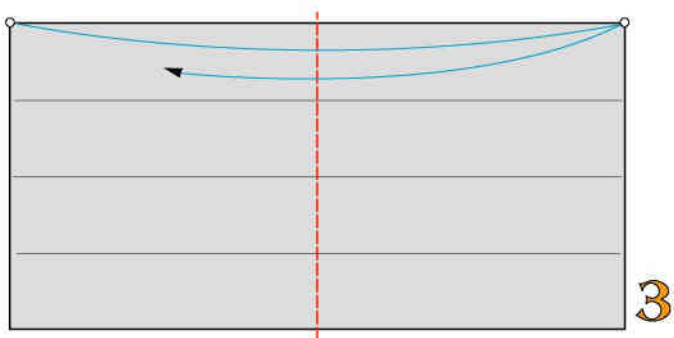

1 piega a valle

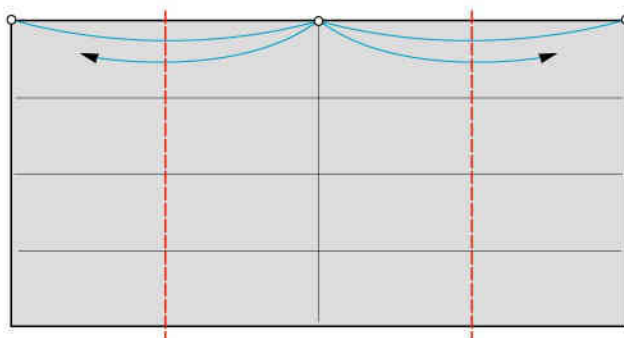

2 pieghe a valle

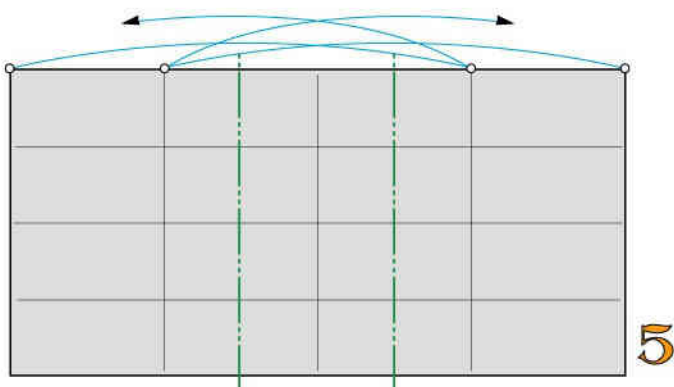

2 pieghe a monte e ribaltate

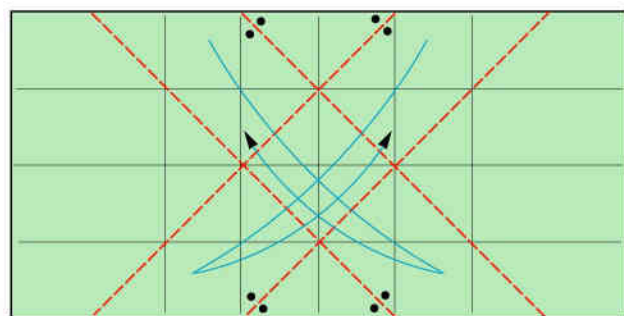

4 pieghe bisettrici a valle

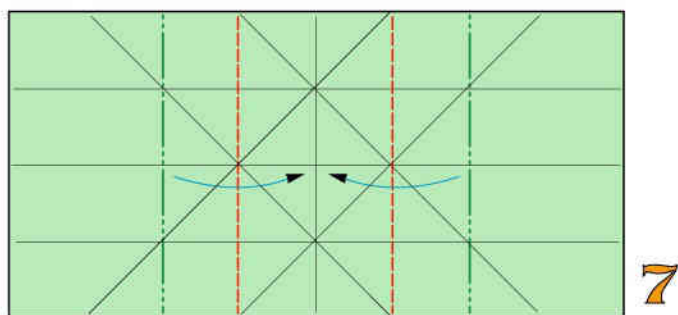

Ripiegate a valle e a monte

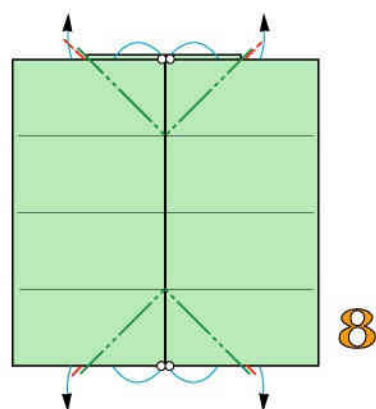

4 pieghe rovesce interne

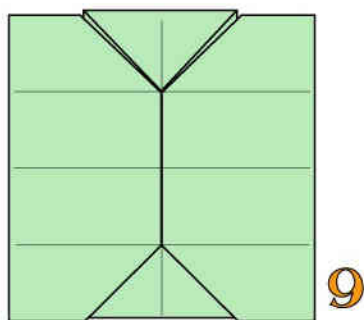

Ribaltate

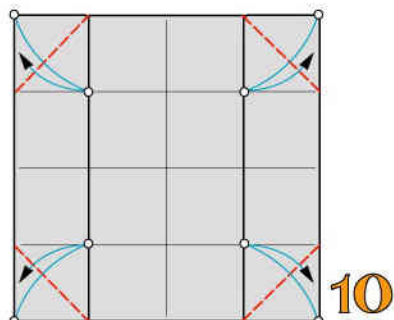

4 pieghe diagonali a valle

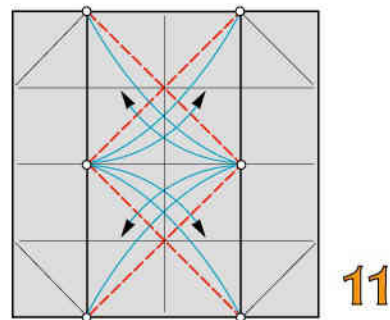

4 pieghe diagonali a valle solo sulla superficie in vista

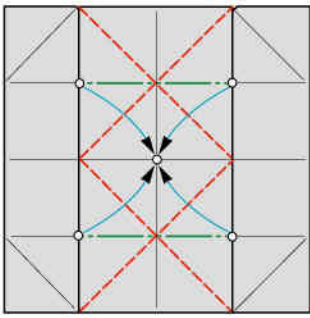

12

Ripiegate a valle a monte

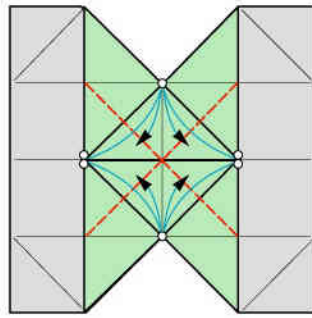

13

4 pieghe diagonali a valle

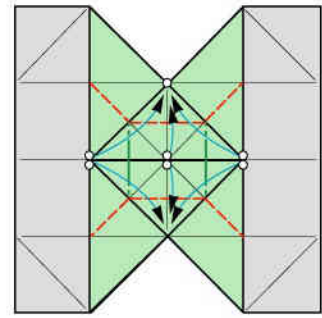

14

6 piccole pieghe a valle e 2 a monte

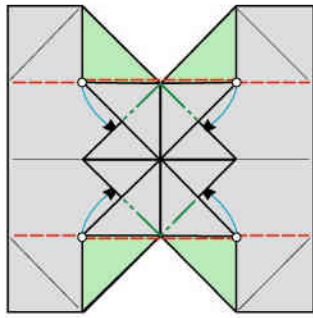

15

4 pieghe a monte e ripiegate a valle

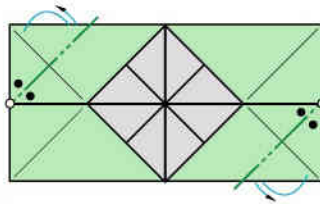

16

2 pieghe bisettrici a monte

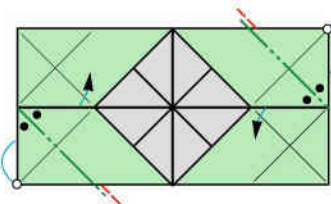

17

2 pieghe rovesce interne

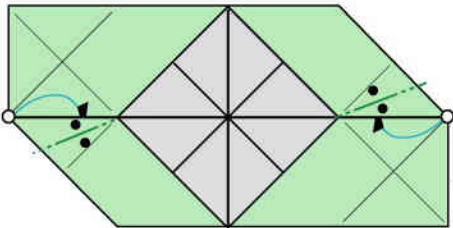

18

2 pieghe bisettrici a monte

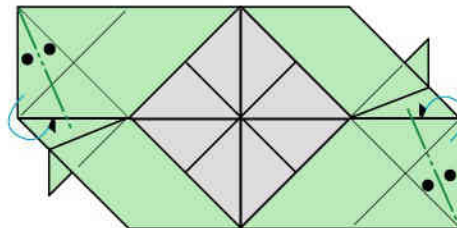

19

2 pieghe bisettrici a monte

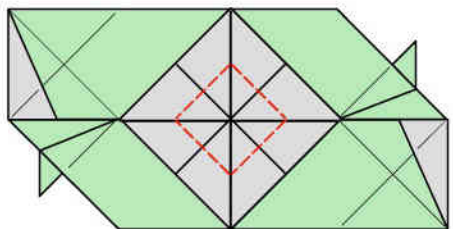

20

4 pieghe a valle

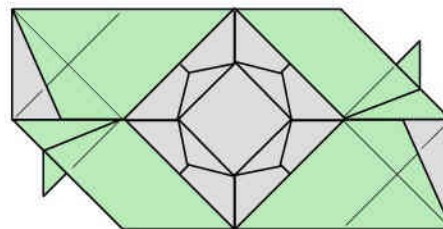

21

Modulo per poliedri "E" ultimato

UNIONE DEI MODULI

Inserite un modulo nell'altro

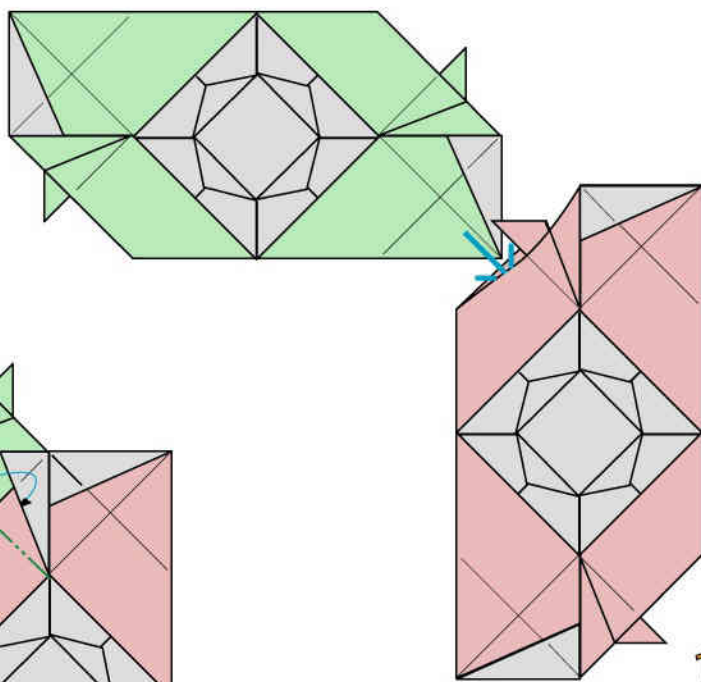

Mediante 1 piega a monte bloccate l'unione

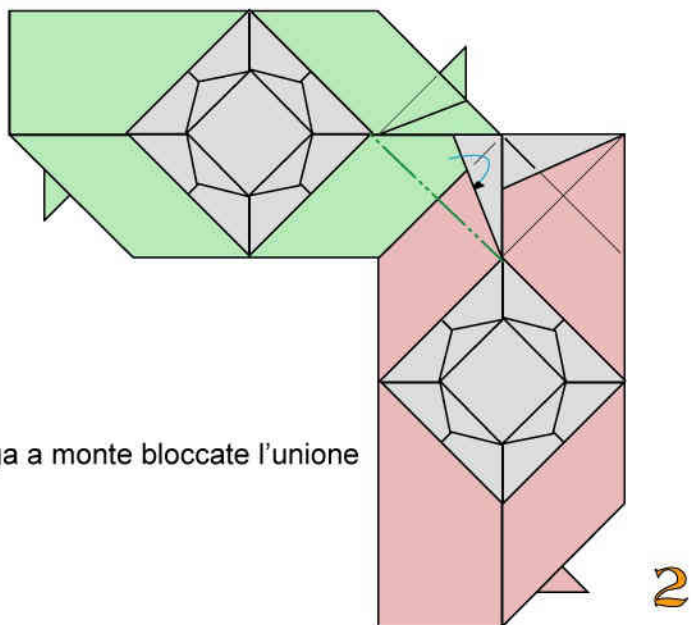

Ripiegate a 3D a valle e a monte per irrigidire l'unione

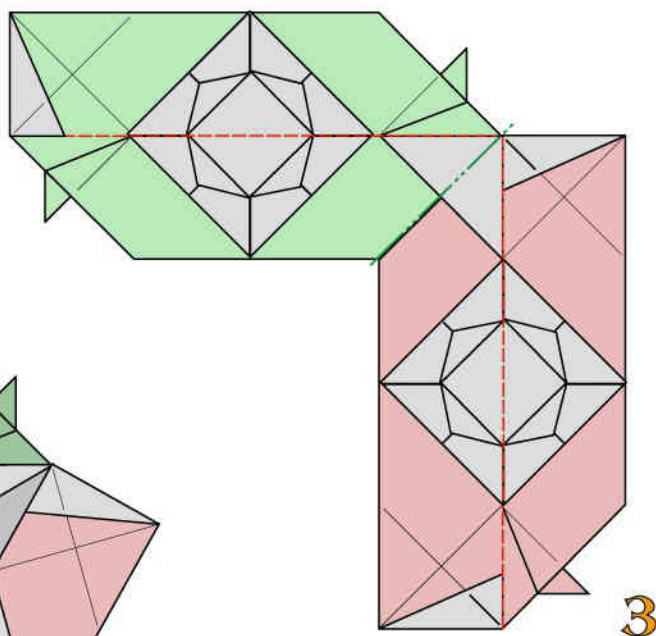

Unione completata

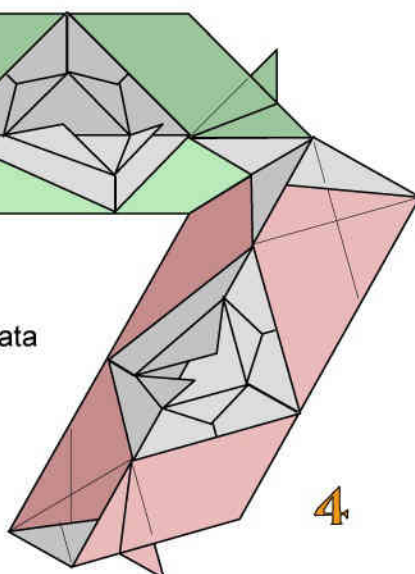

POLIEDRO MODULARE PIRAMIDATO "F"

Franco Pavarin 23

Il poliedro di base delle piramidi è un icosaedro, avente 20 facce a triangolo equilatero.

Si costruisce con 30 moduli da realizzare con carta bicolore leggera delle dimensioni di cm 10x10

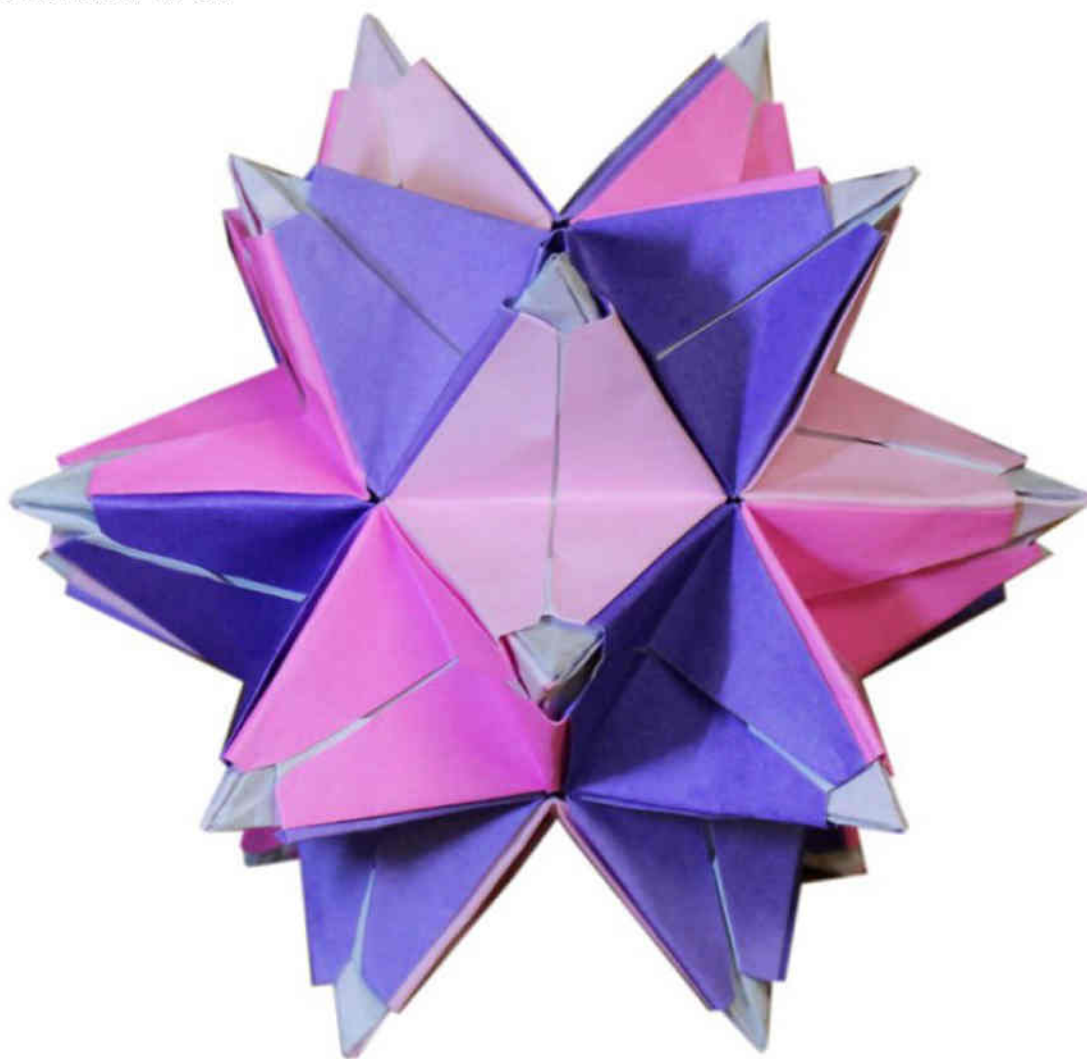

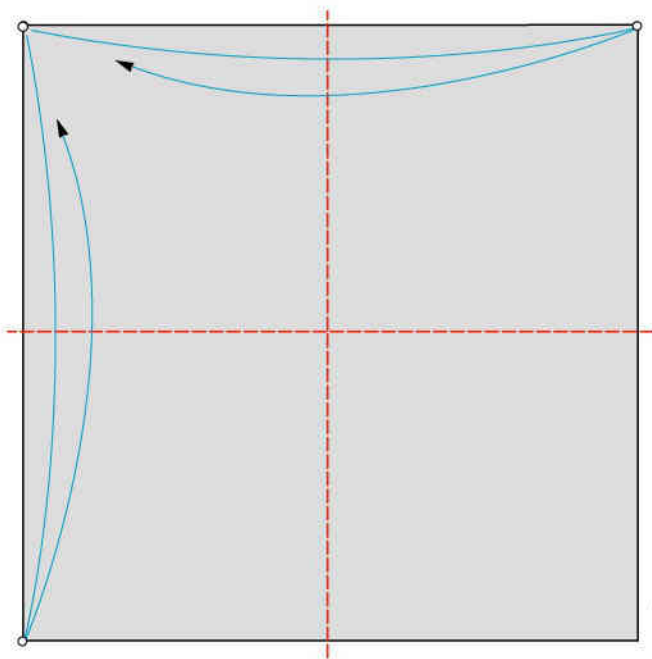

1

2 pieghe a valle

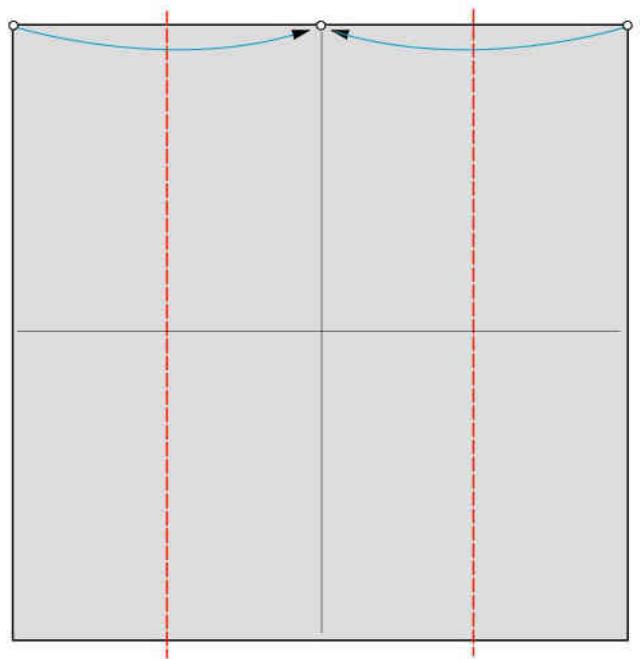

2

2 pieghe a valle

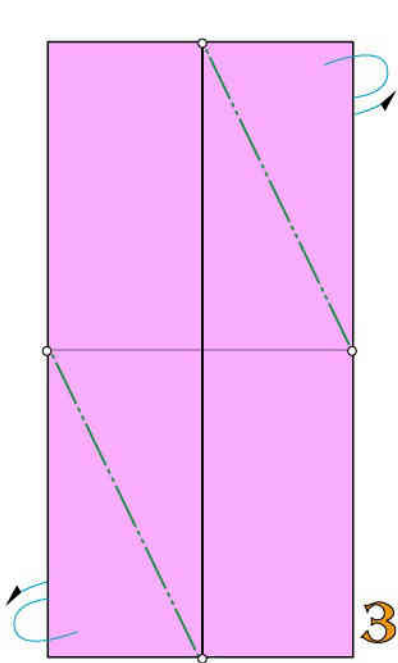

3

2 pieghe a monte

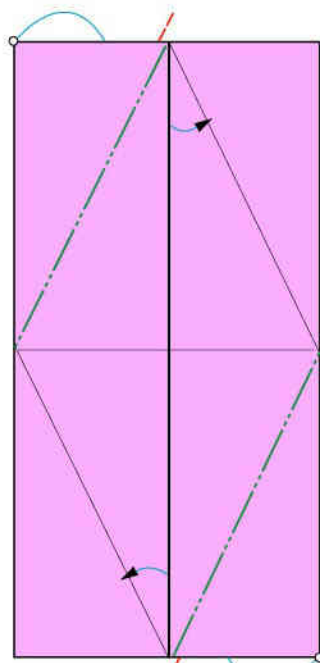

4

2 pieghe rovesce interne

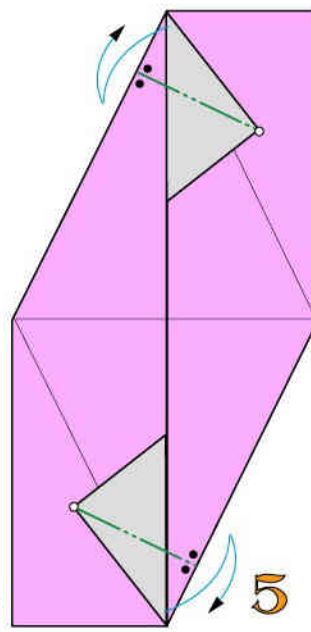

5

2 pieghe bisettrici a monte
solo sulla superficie in vista

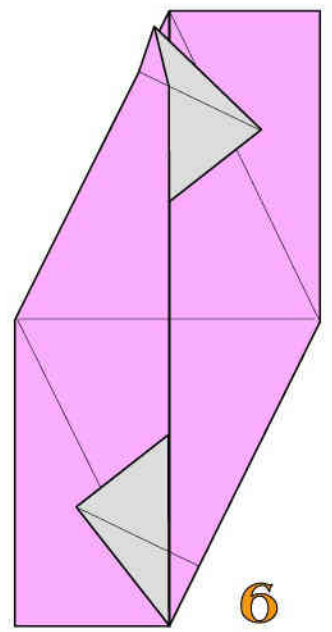

6

Modulo per poliedri
"F" ultimato

UNIONE DEI MODULI

Inserite 1 modulo nell'altro

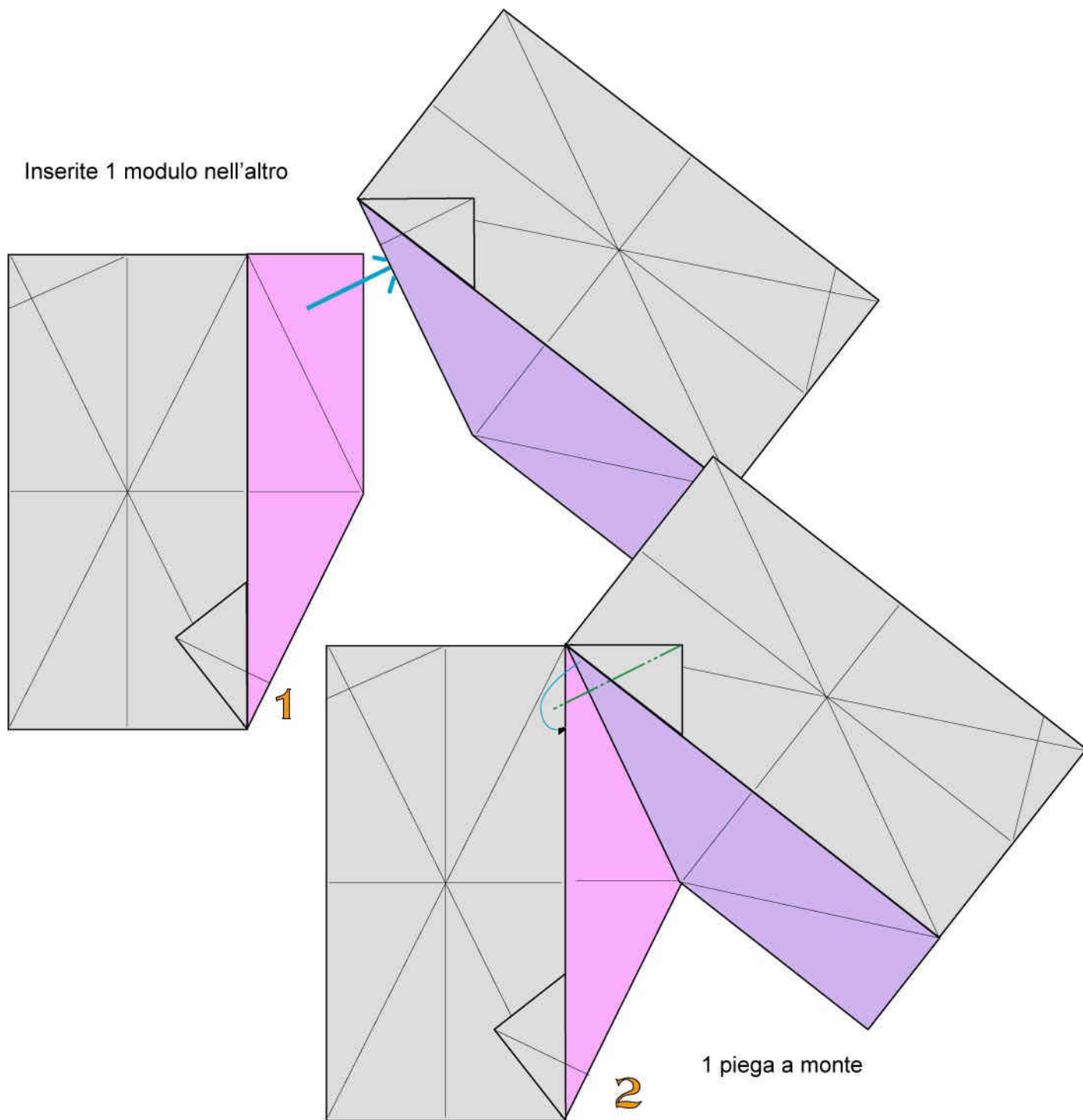

Mediante una piega a monte
bloccate l'unione

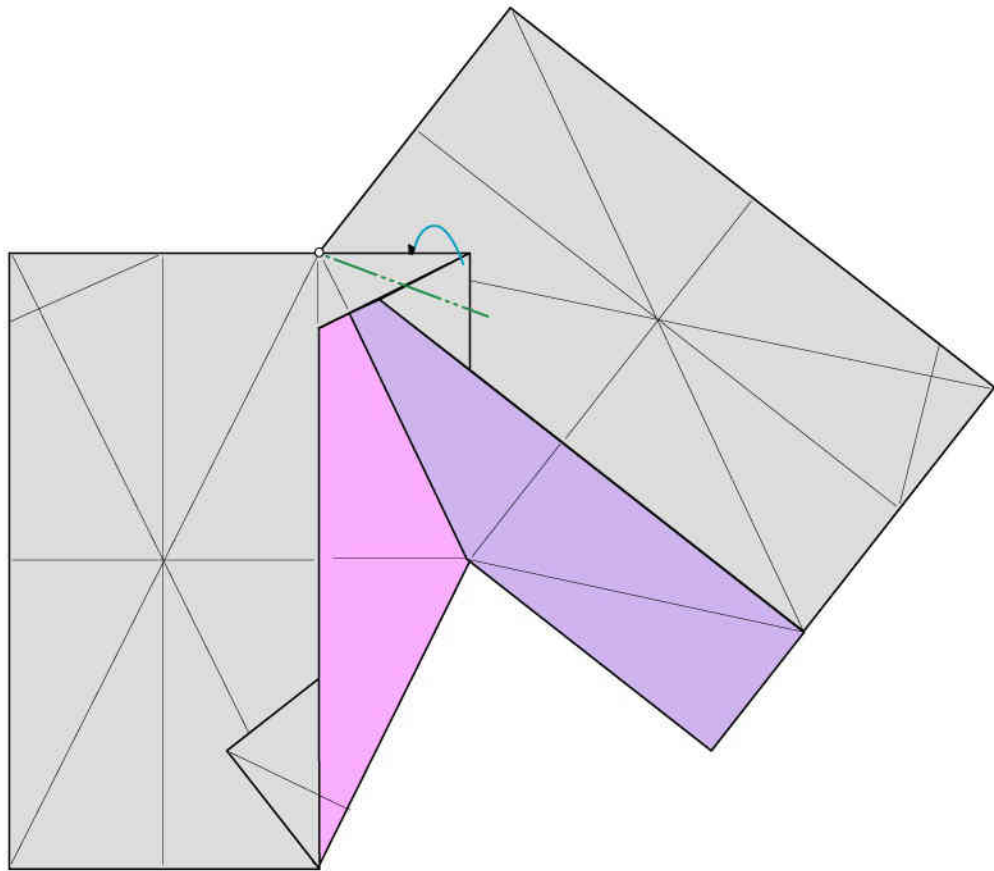

3

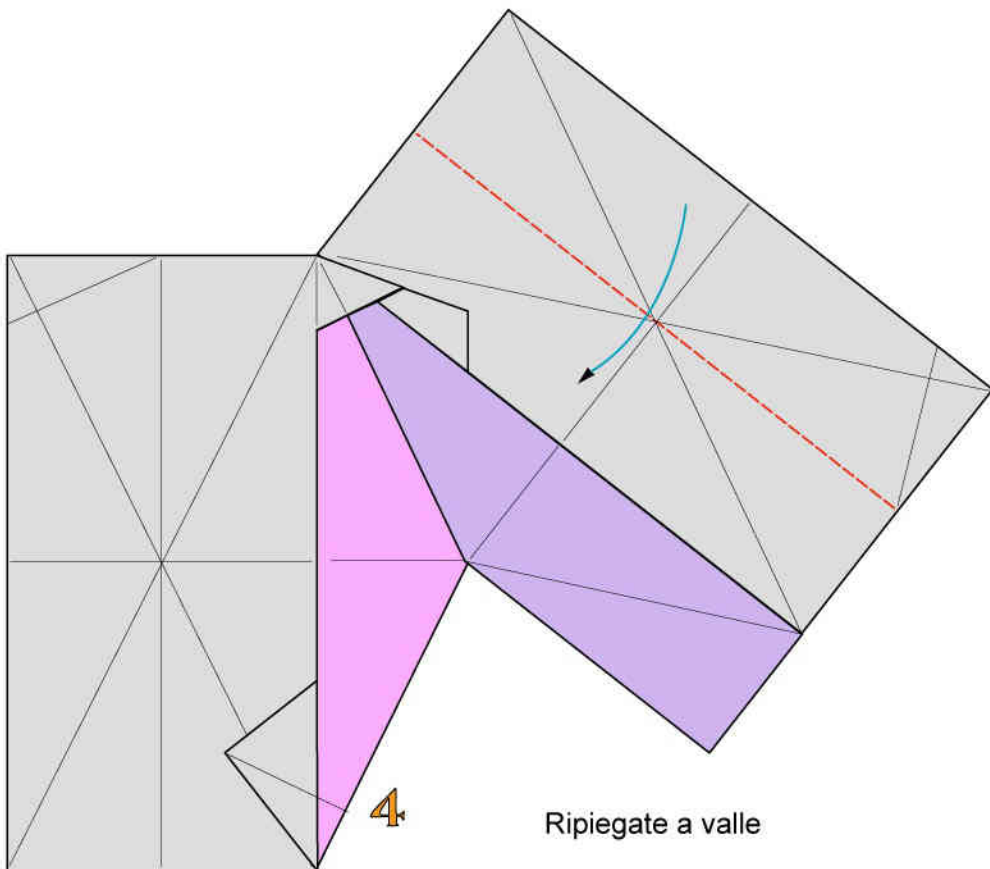

4

Ripiegate a valle

Inseite 1 altro modulo

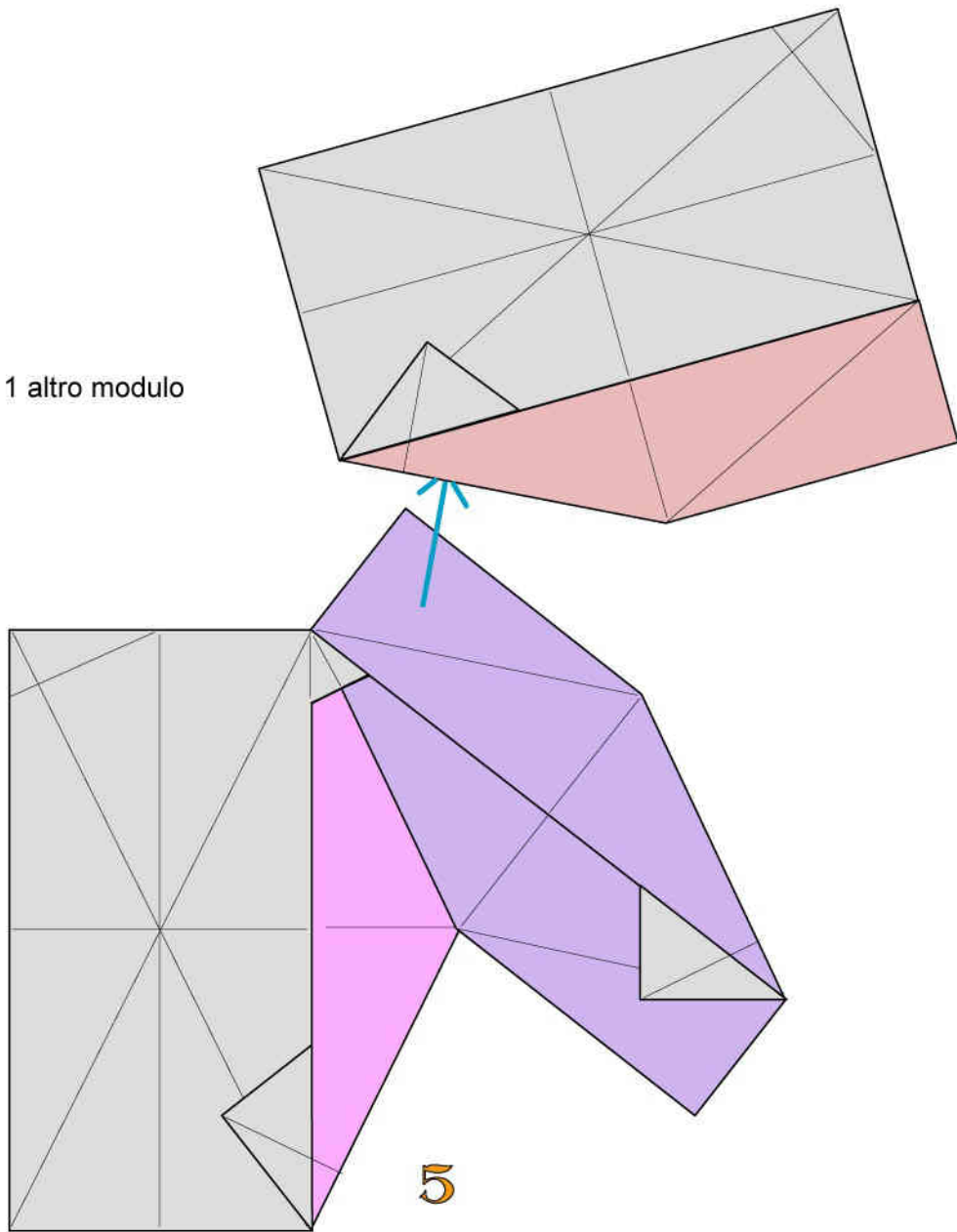

1 piega a monte

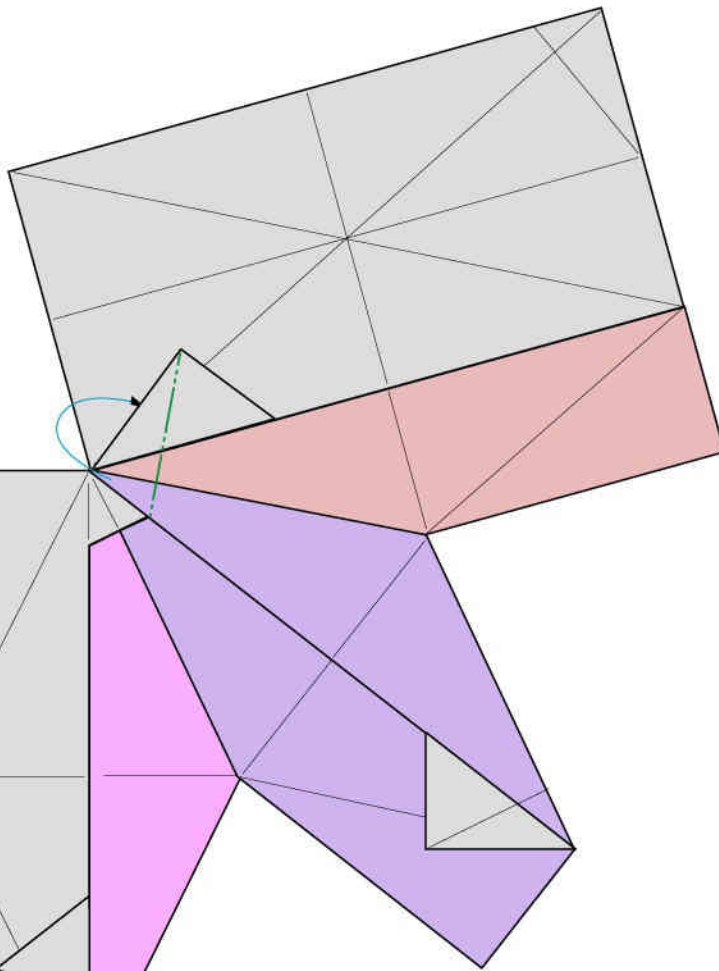
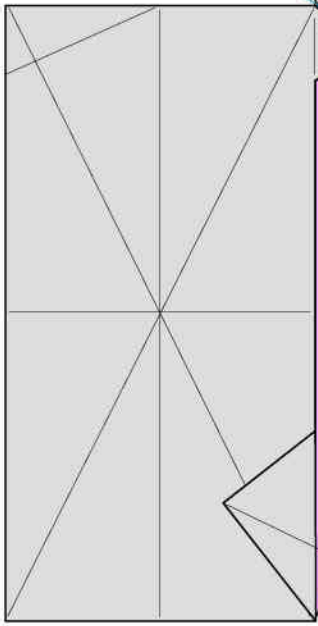

6

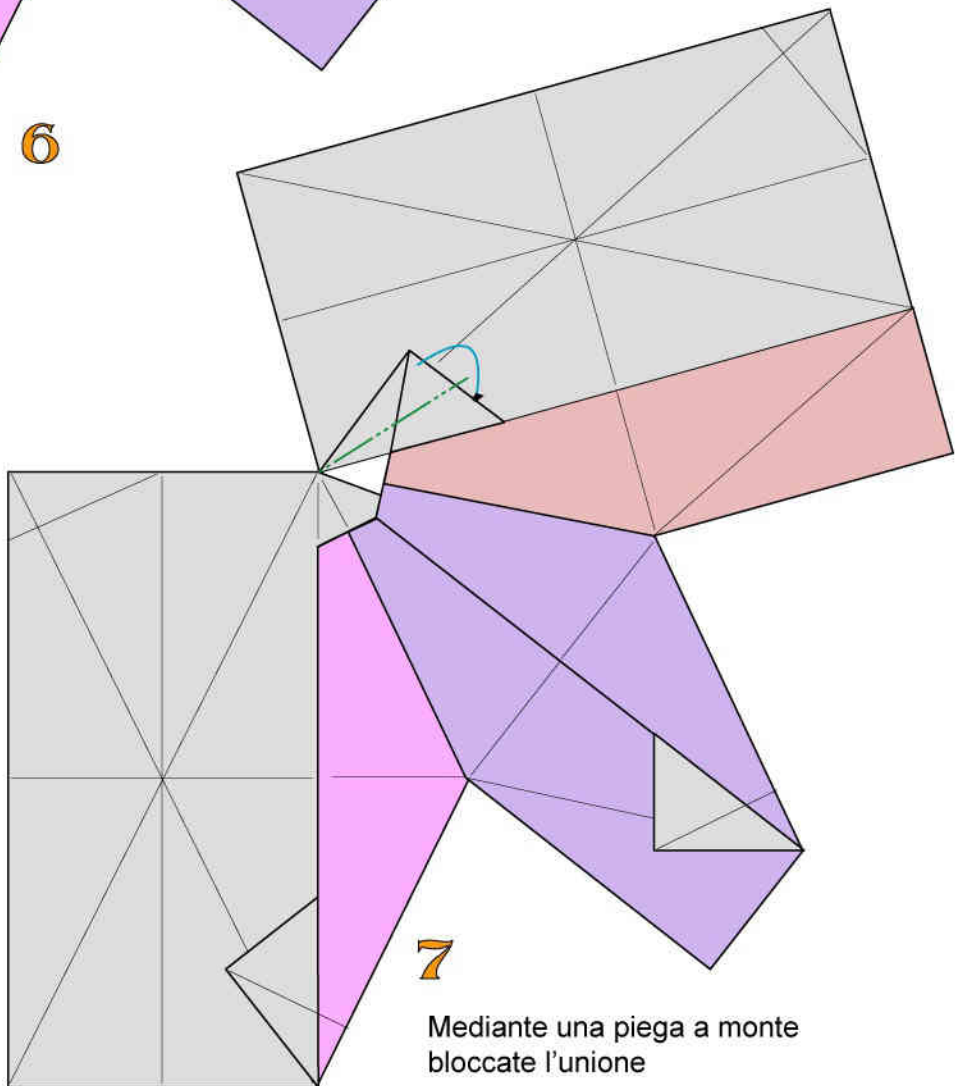

7

Mediante una piega a monte
bloccate l'unione

Ripiegate a valle

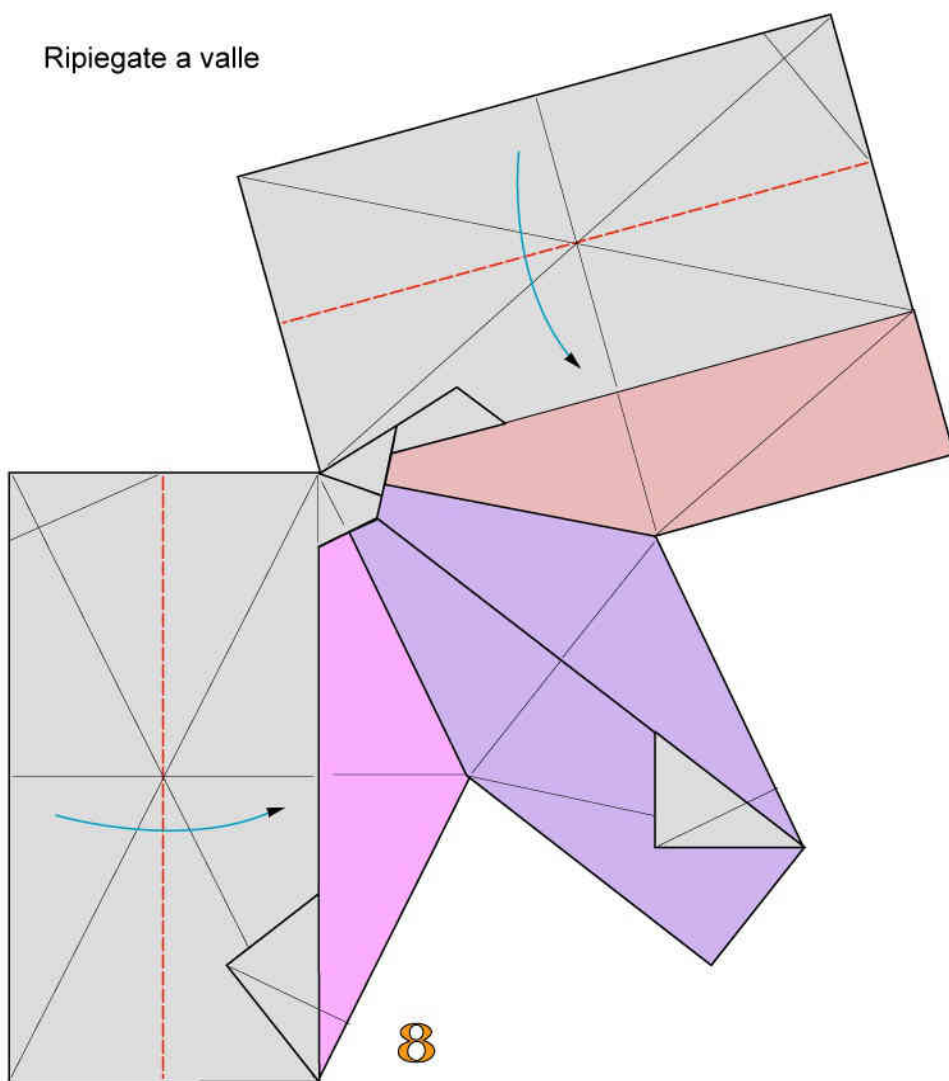

Completate 1 piramide procedendo
come già visto

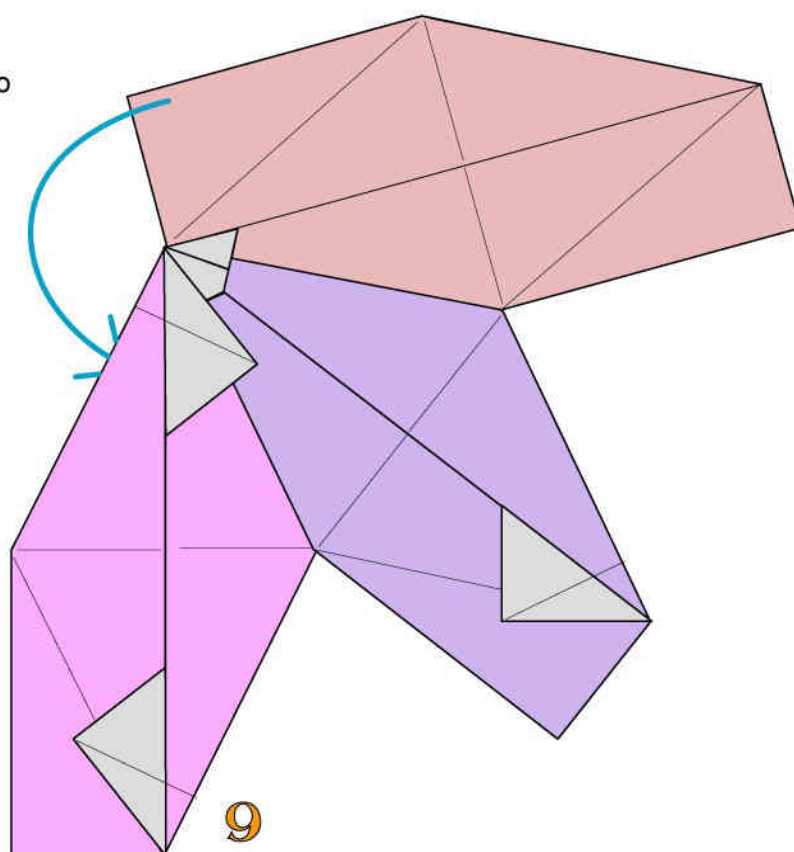

POLIEDRO MODULARE TRAFORATO "G"

Franco Pavarin 23

Con questo modulo si possono costruire molti solidi.
Quello in fotografia è un cubo, cioè un solido regolare con 6 facce a quadrato.
Per la costruzione adoperate 12 fogli rettangolari monocolori di carta di medio peso di almeno cm 12x6

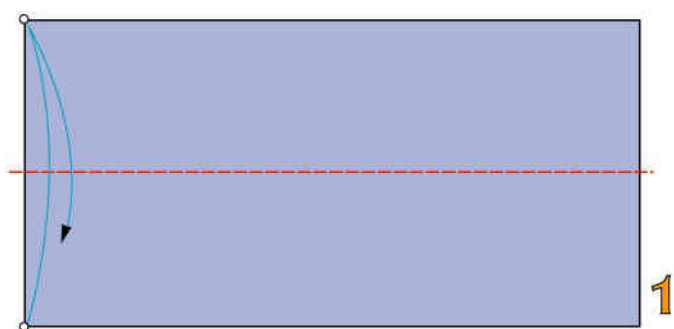
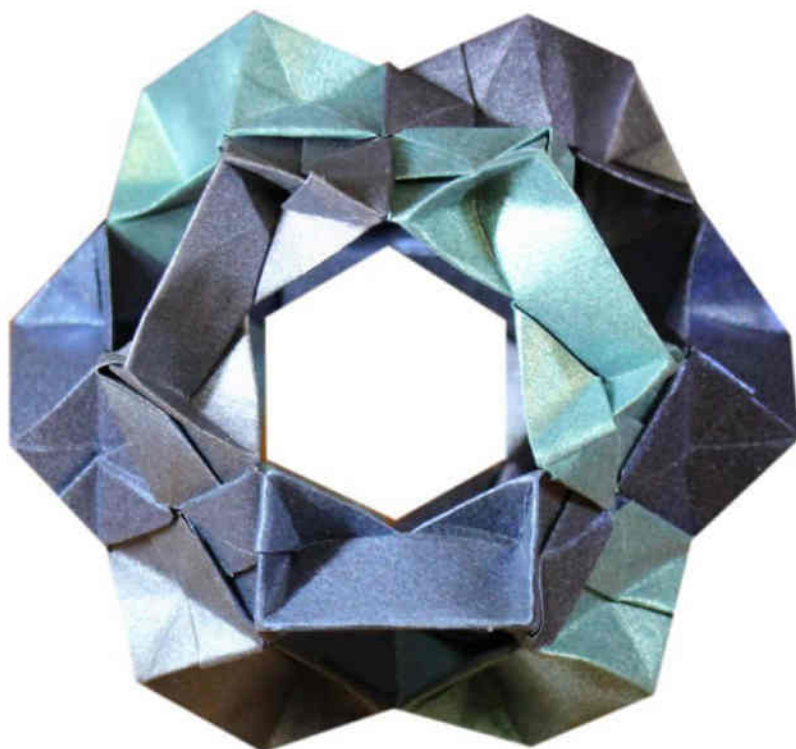

1 piega a valle

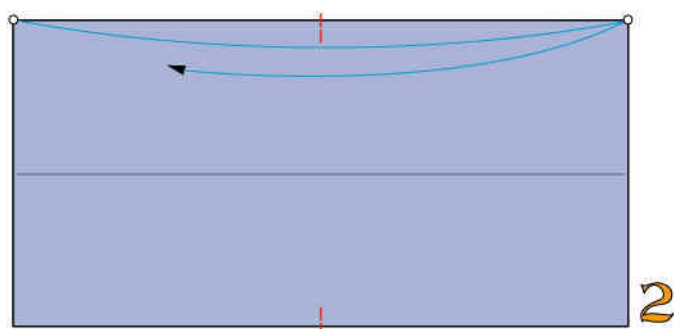

2 piccole pieghe a valle

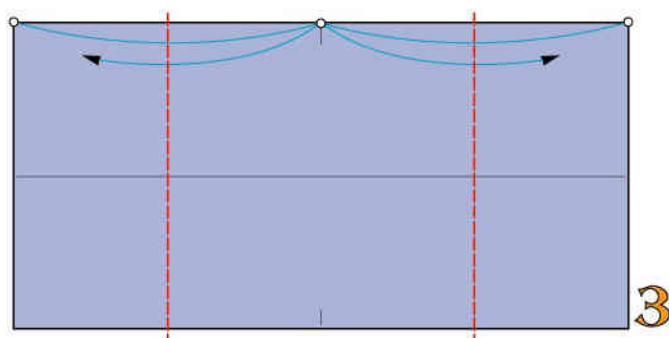

2 pieghe a valle

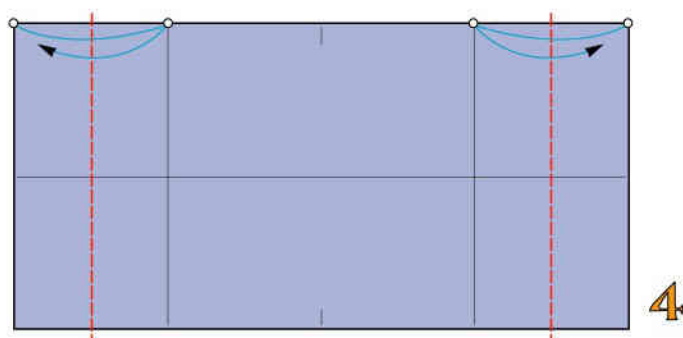

2 pieghe a valle

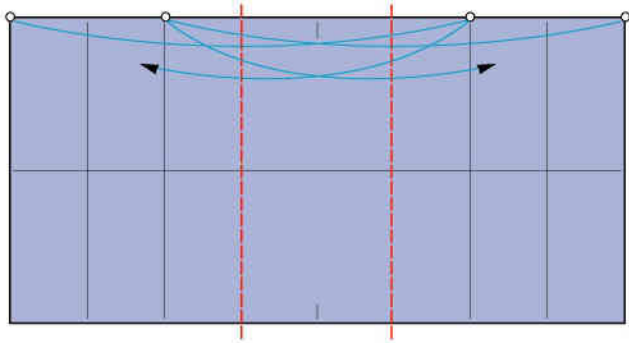

2 pieghe a valle

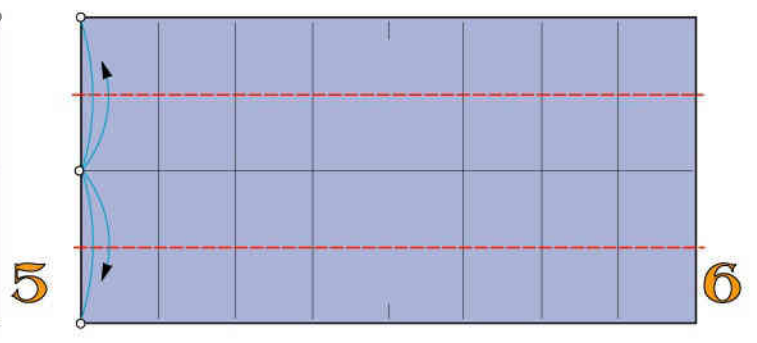

2 pieghe a valle

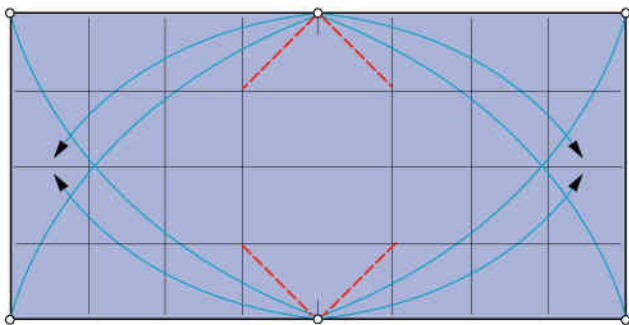

2 pieghe diagonali a valle

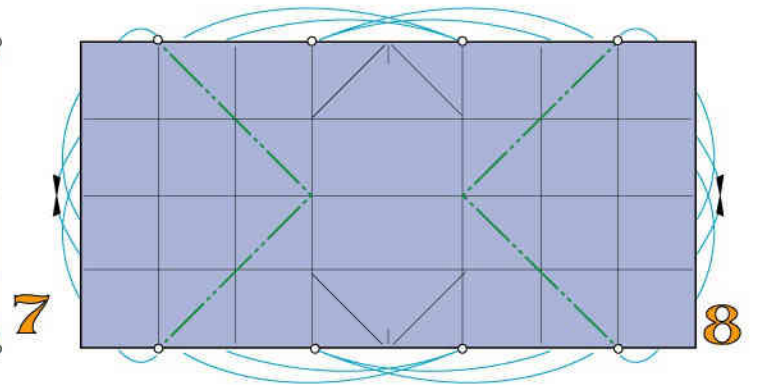

4 pieghe diagonali a monte

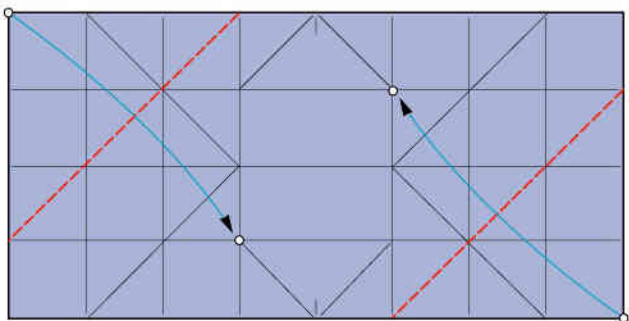

2 pieghe diagonali a valle

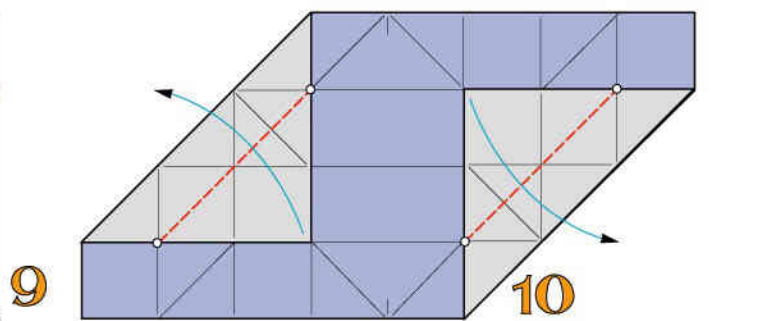

2 pieghe diagonali a valle

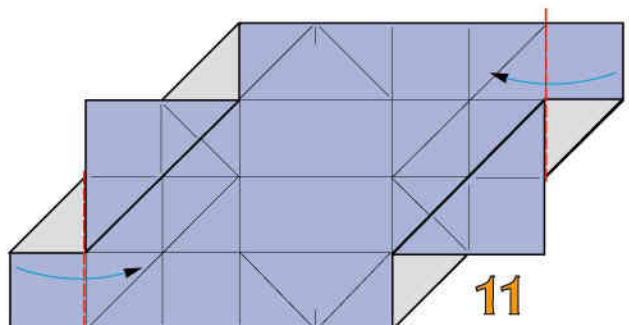

Ripiegate a valle

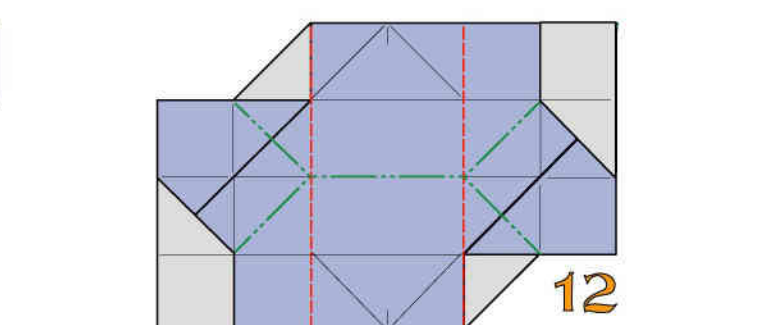

Ripiegate a valle e a monte modellando 3D

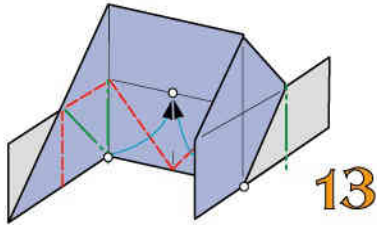

Ripiegate a valle e a monte modellando 3D

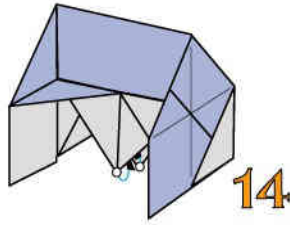

Intascate i 2 vertici inferiori

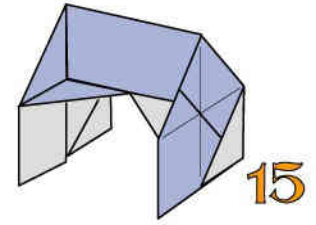

Modulo per poliedri "G" ultimato

UNIONE DEI MODULI

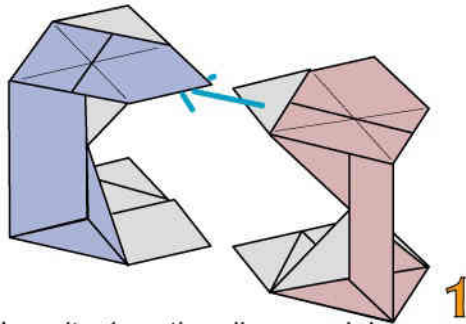

Inserite 1 vertice di un modulo nella tasca di un altro

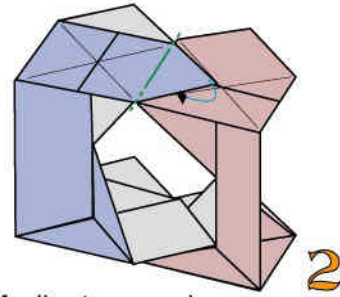

Mediante una piega a monte bloccate l'unione

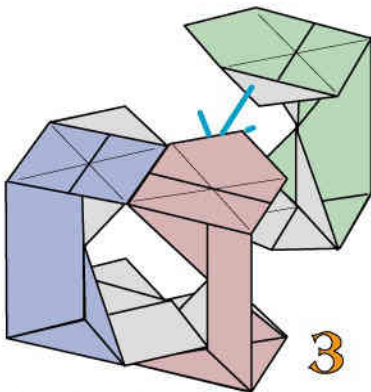

Inserite 1 vertice di un altro modulo nella tasca del secondo

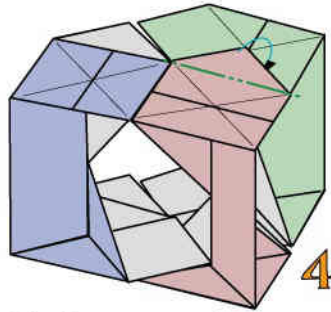

Mediante una piega a monte bloccate l'unione

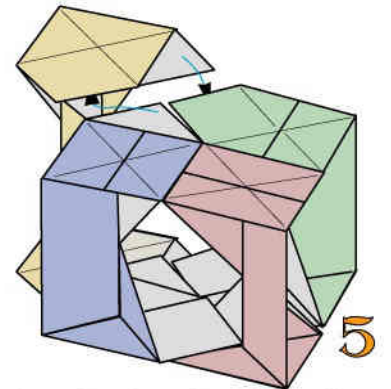

Inserite 1 vertice di un altro modulo nella tasca del terzo

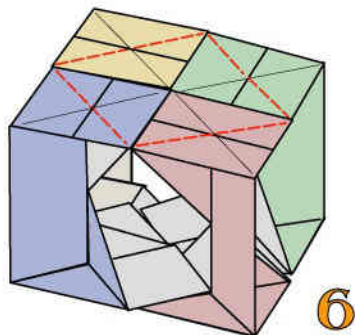

4 pieghe a valle

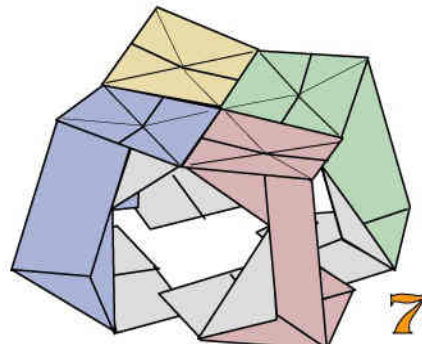

4 moduli uniti

POLIEDRO MODULARE TRAFORATO "H"

Franco Pavarin 23

Si tratta di un icosaedro, poligono regolare con 20 facce a triangolo equilatero. Si costruisce con 30 moduli da realizzare con carta bicolore leggera e delle dimensioni di cm 15x15

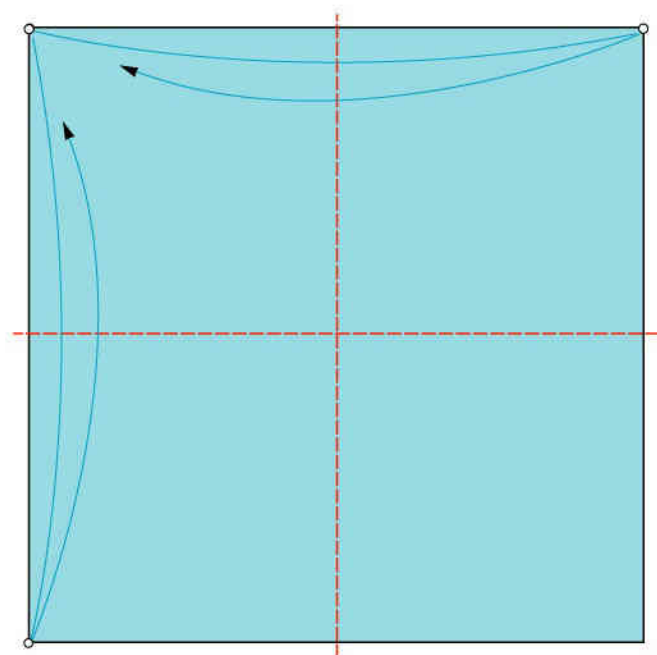
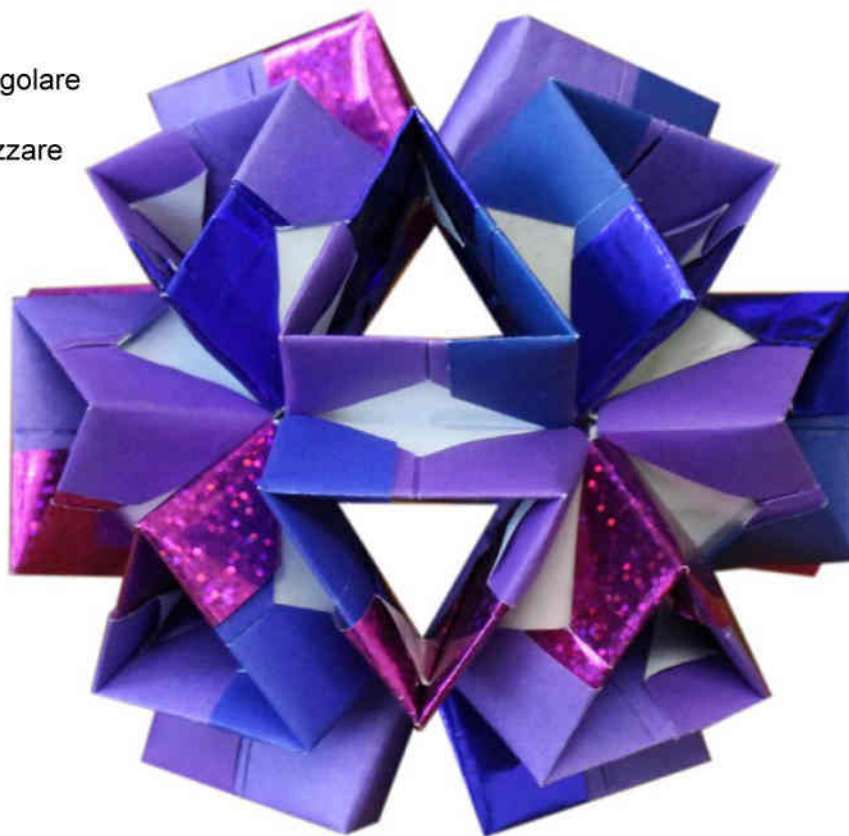

2 pieghe a valle

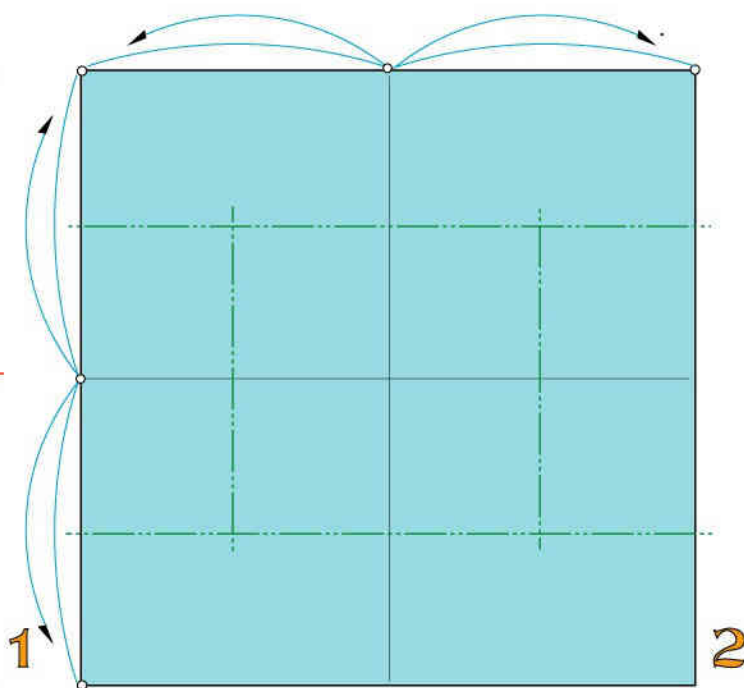

4 pieghe a monte

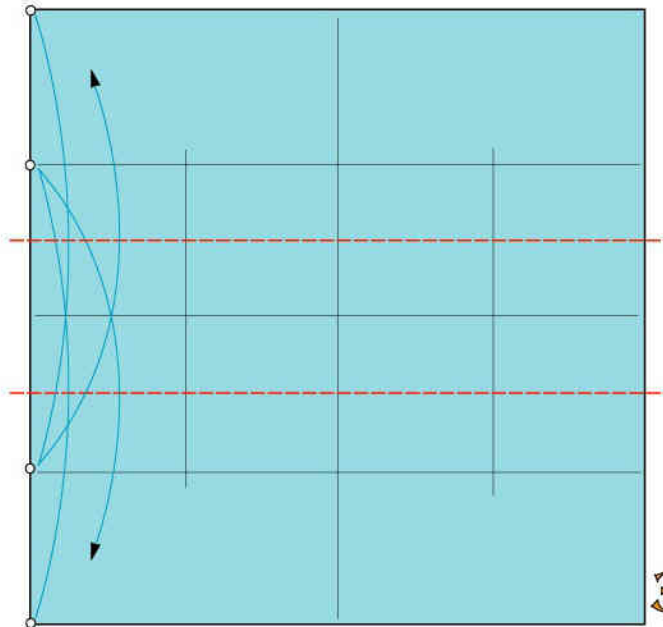

3

2 pieghe a valle

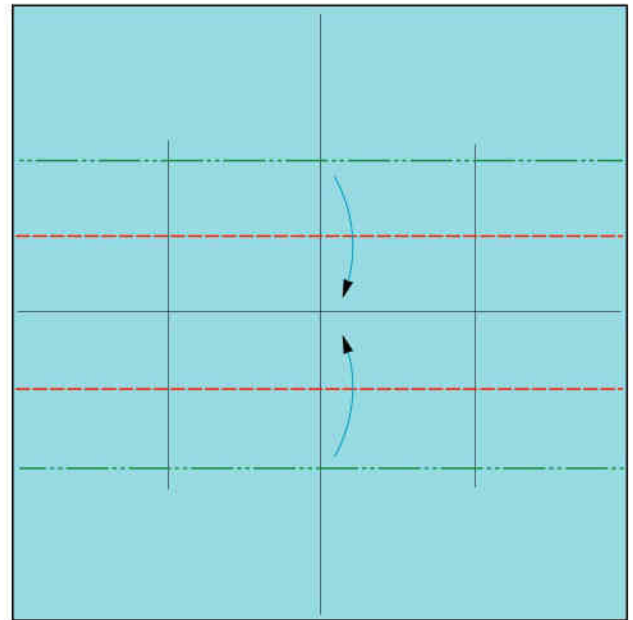

4

Ripiegare a valle e a monte

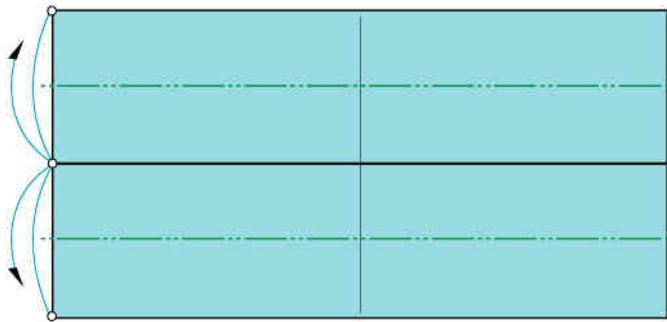

5

2 pieghe a monte

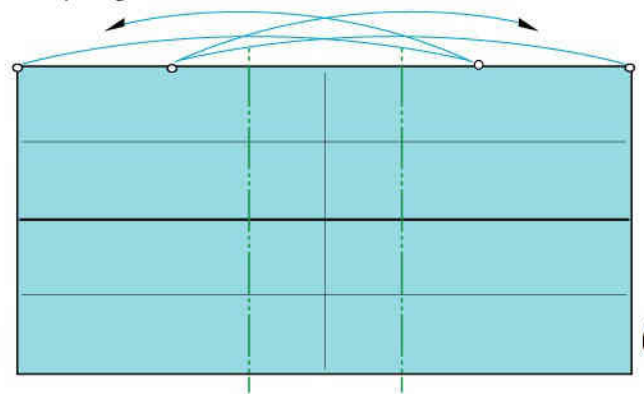

6

2 pieghe a monte

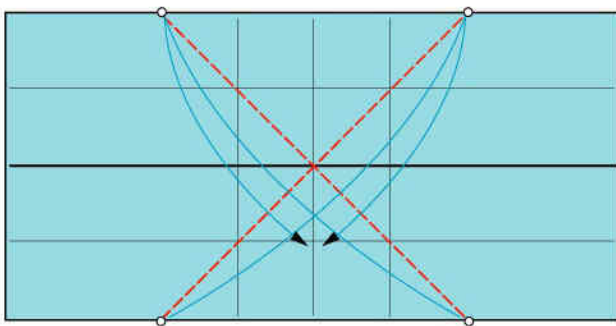

7

2 pieghe a valle

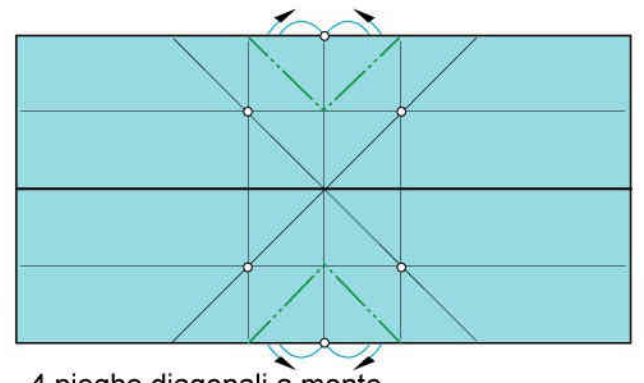

8

4 pieghe diagonali a monte

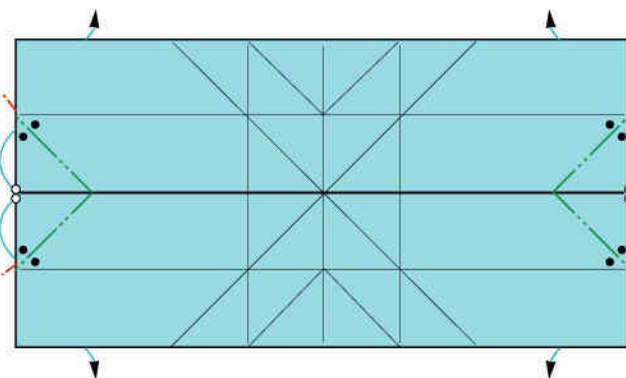

9

4 pieghe bisettrici a monte

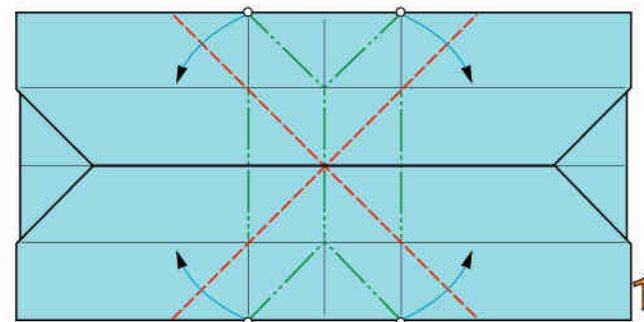

10

Ripiegare a valle e a monte

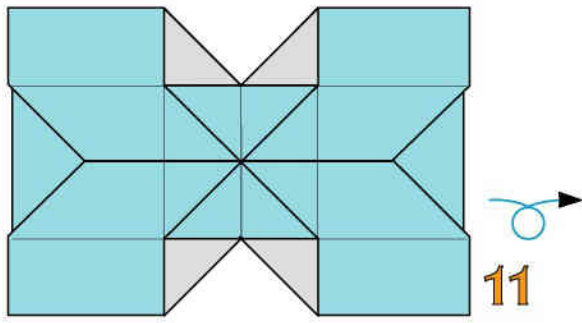

Ribaltate

11

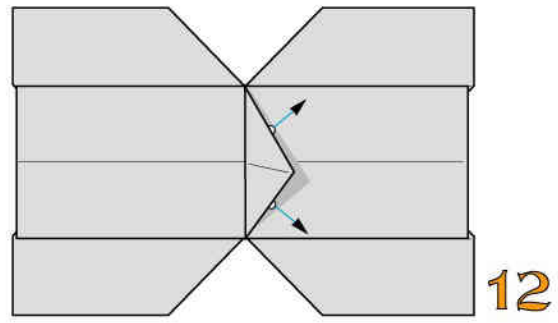

Estraete i 2 vertici interni

12

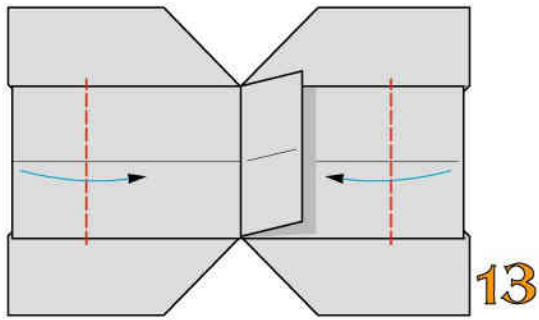

2 pieghe a valle

13

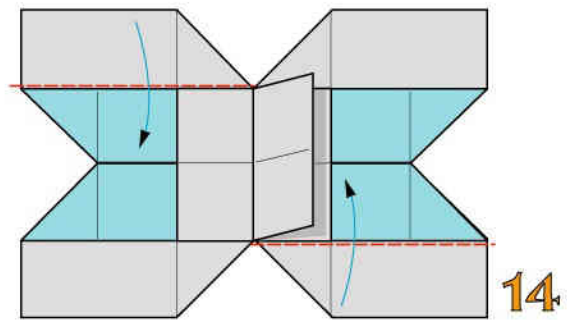

Ripiegate a valle

14

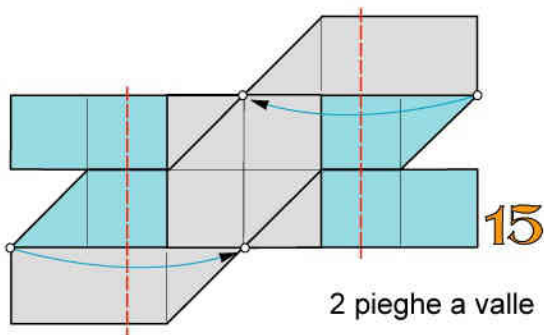

2 pieghe a valle

15

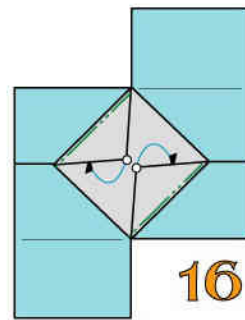

2 pieghe a monte e intascate

16

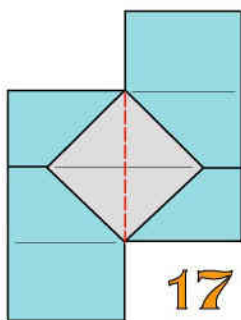

1 piega a valle

17

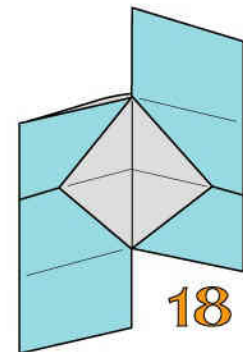

Modulo per poliedri "H" ultimato

18

UNIONE DEI MODULI

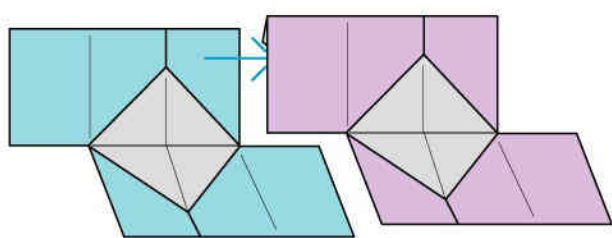

1

Inserite un modulo nell'altro

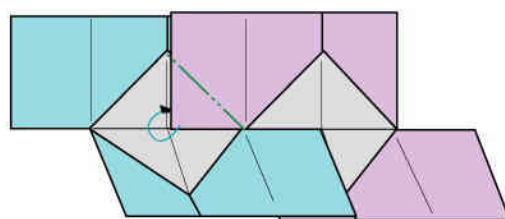

2

Mediante 1 piega a monte bloccate l'unione

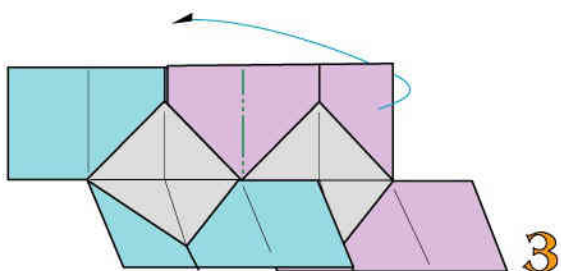

3

1 piega a monte

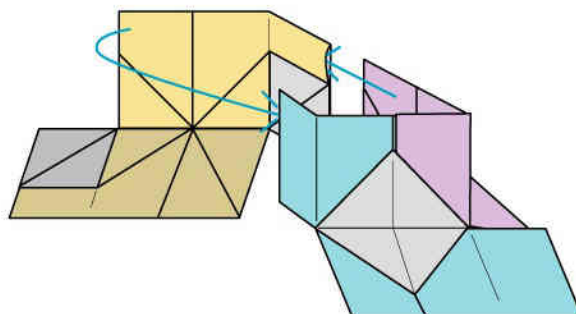

4

Inserite un altro modulo per realizzare una faccia triangolare e bloccate come visto precedentemente

PUBBLICAZIONI DI FRANCO PAVARIN

| | | |
|-------------------------------------------|---------------------|------|
| Aerei , jet ed astronavi di carta volanti | IL CASTELLO | 1986 |
| Origami animati | " | 1987 |
| Origami maschere animate | " | 1988 |
| Decorazioni modulari con origami modulati | " | 1989 |
| Origami motoscafi navi barche e velieri | " | 1990 |
| Origami scatole e contenitori | " | 1990 |
| Pieghe forme e colori | " | 1994 |
| Aerei e navi di carta | FABBRI | 1996 |
| Fold and fly Paper airplanes | STERLING PUBLISHING | 1998 |
| Manuale rapido di aerei di carta volanti | FABBRI | 2000 |
| Aerei di carta 17 modelli volanti inediti | IL CASTELLO | 2001 |
| Aviones voladores | TUTOR S.A. | 2003 |
| 17 modelos ineditos de aviones voladores | " | 2004 |
| Naves voladoras | " | 2006 |
| Quaderni Quadrato magico n.20 e 48 | CDO | |
| Maschere, elmi e copricapi | web | 2010 |
| Maschere trasformabili | web | 2011 |
| 21 nuovi aerei origami volanti | web | 2014 |
| Maschere origami 3D volume 1 | web | 2014 |
| Maschere origami 3D volume 2 | web | 2015 |
| Legorigami 1 -Q.Quadrato Magico n.56 | CDO | 2015 |
| Composizione modulare 1 | web | 2016 |
| Manuale dell'architetto origamista | web | 2016 |
| 13 moduli origami aggregabili | web | 2017 |
| Alfabeti origami | web | 2018 |
| 21 Elmi e strani copricapi origami | web | 2019 |
| Animaletti semplici origami | web | 2020 |
| Origami per giocare | web | 2020 |
| 30 nuovi origami volanti | web | 2021 |
| Contenitori 1 | web | 2021 |
| Contenitori 2 | web | 2021 |
| Contenitori 3 | web | 2022 |
| Contenitori 4 | web | 2022 |
| Volti scolpiti origami 1 | web | 2018 |
| Volti scolpiti origami 2 | web | 2019 |
| Contenitori 5 | web | 2022 |

| | | |
|---------------------------------|-----|------|
| Manuale di arredamento | web | 2022 |
| Composizione modulare 2 | web | 2023 |
| Castelli e fortezze componibili | web | 2023 |
| Contenitori origami 6 | web | 2023 |
| Navi, barche e velieri | web | 2023 |

