

franco Pavarin

www.origami-cdo.it/francopavarin/

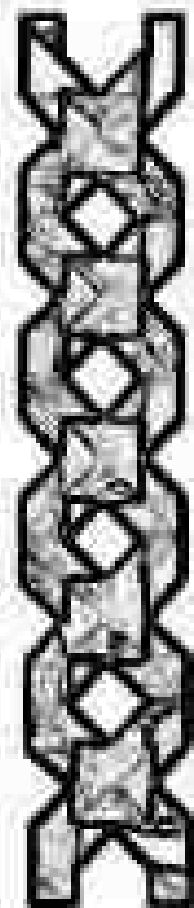
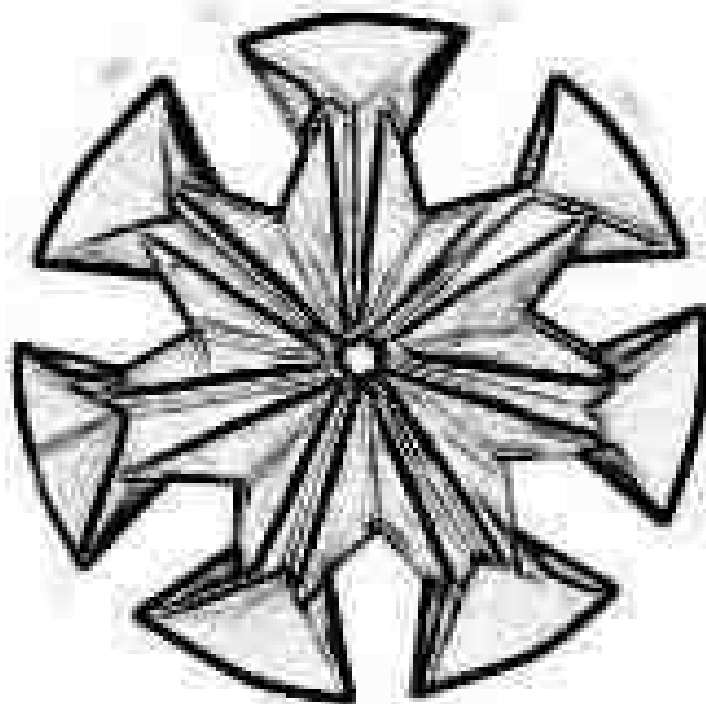
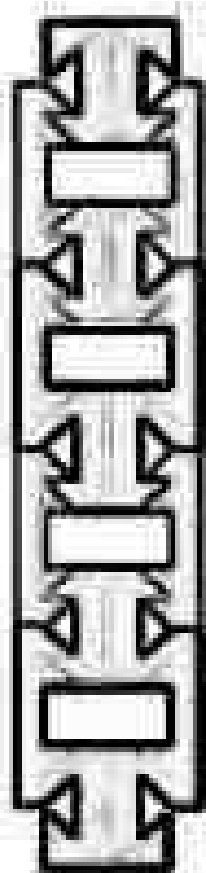

Francesco Pavesini
www.pavesini.com

PREFAZIONE

In questo mio periodo di carenza d'ispirazione, ho recuperato e poi disegnato progetti di almeno 20 anni fa, e che ritengo ancora validi.

Si tratta di nastri con le forme più strane, traforati ed elaborati.

Si tratta anche di bracciali ed orecchini, da realizzare con carta metallizzata da irrigidire con smalto per unghie o liquido cristallizzante.

Si tratta anche di tassellazioni dalla strana forma che, montate tridimensionalmente, permettono la costruzione di composizioni a torre.

Marzo 2024

Franco Pavarin

In my period of lack of inspiration, I recovered and then designed projects from at least 20 years ago, which I still consider valid.

These are ribbons with the strangest shapes, perforated and elaborate.

These also include bracelets and earrings, to be made with metallic paper to stiffen with nail polish or crystallizing liquid.

They are also strangely shaped tessellations which, mounted three-dimensionally, allow the construction of tower compositions.

En mi periodo de falta de inspiración recuperé y luego diseñé proyectos de hace al menos 20 años, que todavía considero válidos.

Se trata de cintas con formas de lo más extrañas, perforadas y elaboradas.

También se incluyen pulseras y aretes, que se harán con papel metálico para darle rigidez con esmalte de uñas o líquido cristalizante.

También son teselados de formas extrañas que, montados tridimensionalmente,

Permitir la construcción de composiciones de torre.

Simbologia origami

Indicazione

Risultato 3D

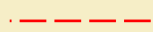

Piega a valle
(piega bassa)

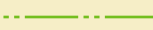

Piega a monte
(piega alta)



Ruotate e piegate



Ruotate, piegate
e riportate alla
posizione iniziale



Ribaltate
sull'asse verticale



Ribaltate sull'asse
orizzontale



Ruotate di 180°

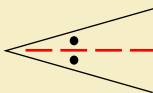

Piega bisettrice
a valle



Figura ingrandita

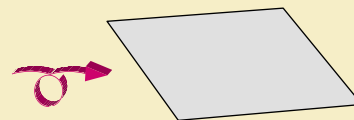
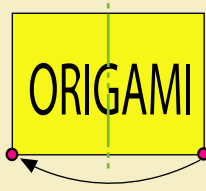
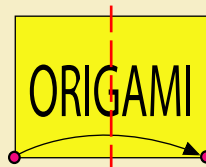
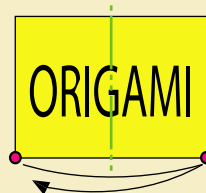

ORIGAMI



ORIGAMI

Realizzazione delle pieghe rovesce

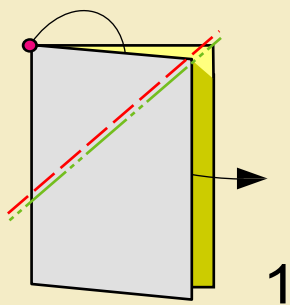

1
Eseguite una piega rovescia interna

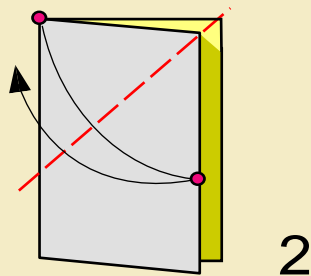

2
Una piega a valle

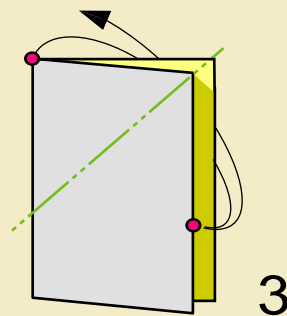

3
Ripiegate con piega a monte sulla medesima traccia

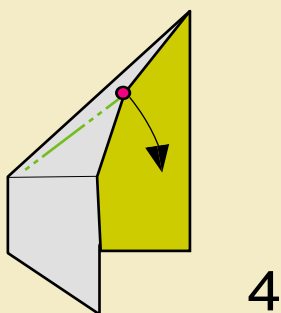

4
Aprite e rovesciate il verso della piega

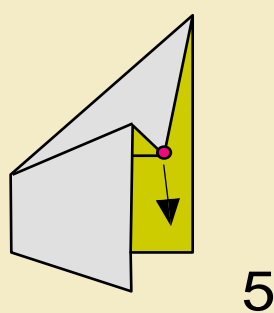

5
Inserite all' interno il vertice indicato

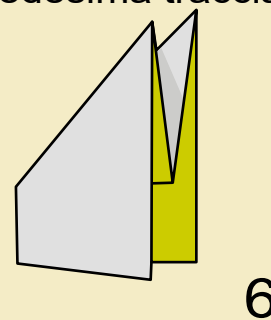

6
Piega rovescia interna ultimata

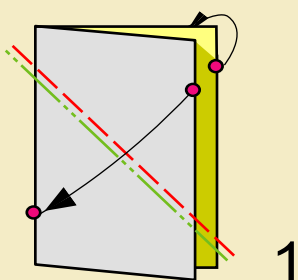

1
Eseguite una piega rovescia esterna

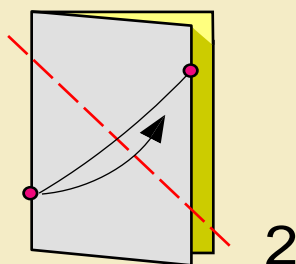

2
Una piega a valle

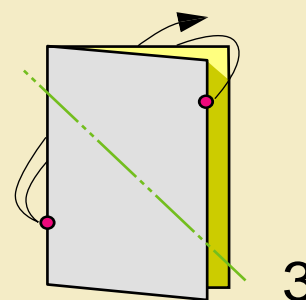

3
Ripiegate con piega a monte sulla medesima traccia

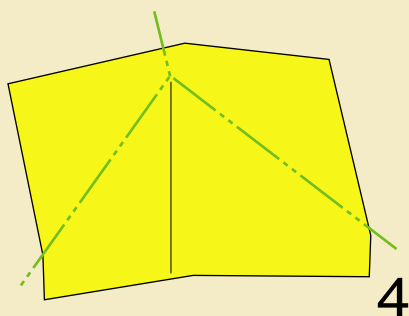



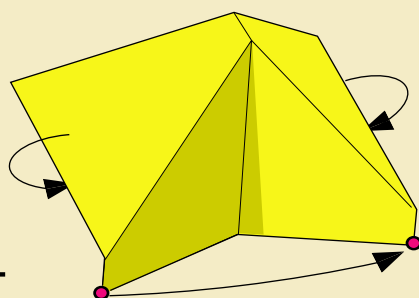



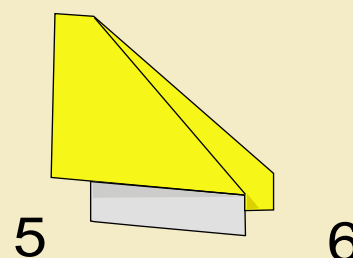





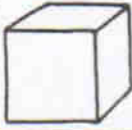







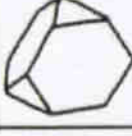





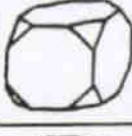

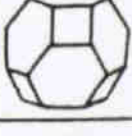





4
Aprite e rovesciate il verso della piega



5
Richiudete



6
Piega rovescia esterna ultimata

NOME	POLIEDRO	numero triangoli	numero quadrati	numero pentagoni	numero esagoni	numero ottagoni	numero vertici	numero spigoli
TETRAEDRO		4 					4	6
CUBO			6 				8	12
OTTAEDRO		8 					6	12
DODECAEDRO				12 			20	30
ICOSAEDRO		20 					12	30
TETRAEDRO TRONCO		4 			4 		12	18
UBOTTAEDRO		8 	6 				12	24
CUBO TRONCO		8 				6 	24	36
OTTAEDRO TRONCO			6 		8 		24	36
PICCOLO ROMBICUBOTTAEDRO		8 	18 				24	48
GRANDE ROMBICUBOTTAEDRO			12 		8 	6 	48	72
CUBO SIMO		32 	6 				24	60
OSIDODECAEDRO		20 		12 			30	60

NASTRO "A" TRAFORATO

Si costruisce unendo moduli per nastro "A"
e moduli di collegamento "A".
Adoperate carta monocolore di medio peso
delle dimensioni di cm 10x10

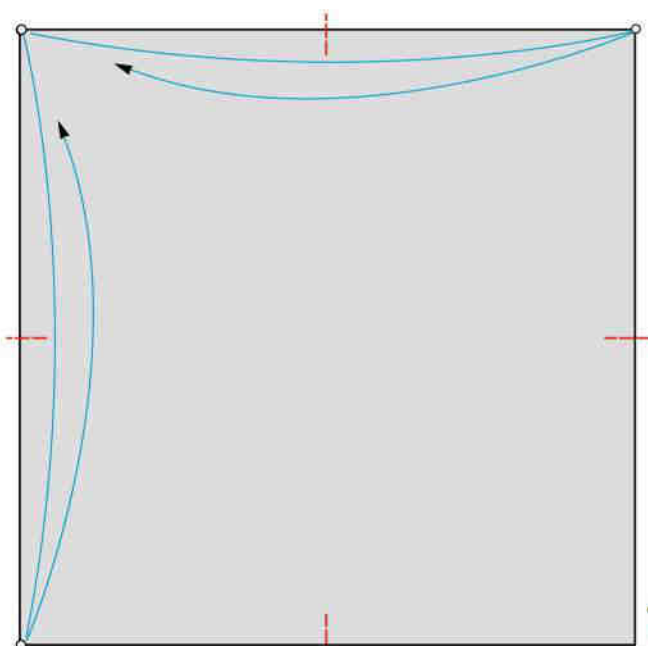
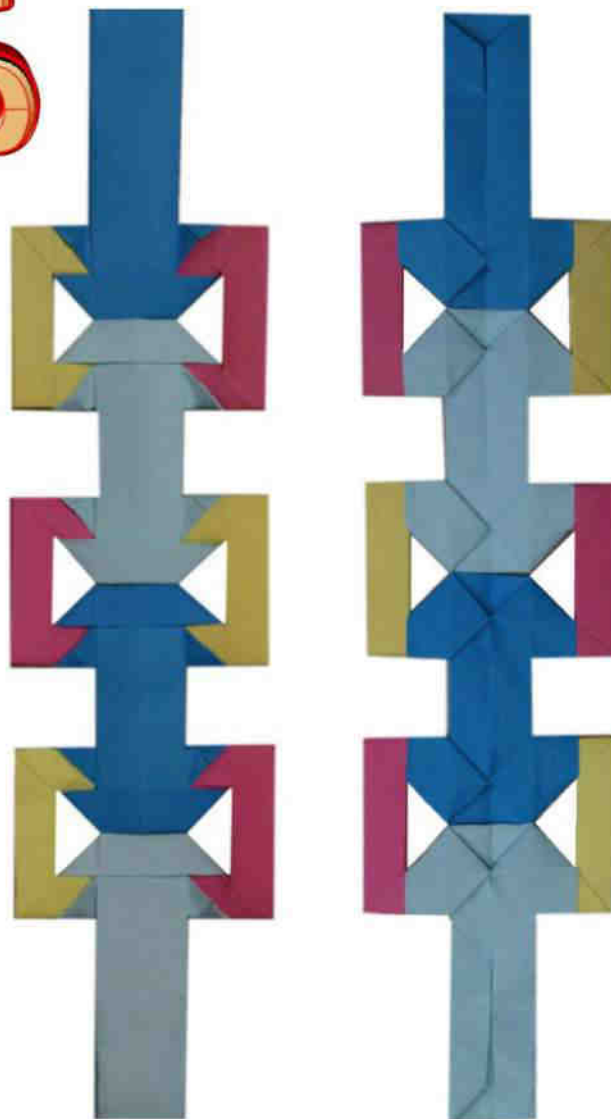

4 piccole pieghe a valle

1

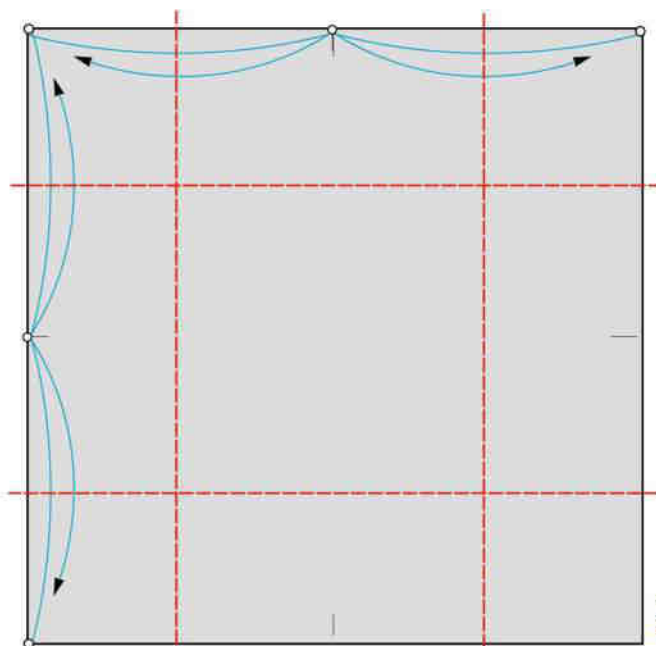

4 pieghe a valle

2

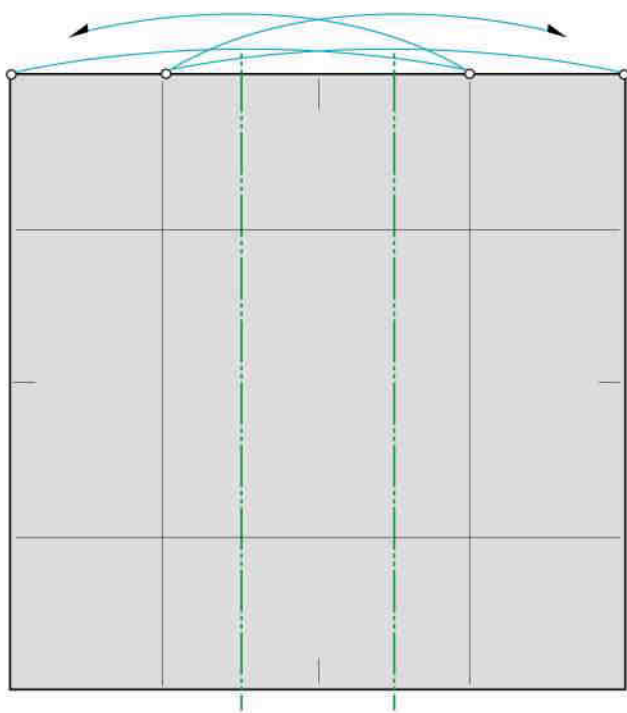

2 pieghe a monte

3

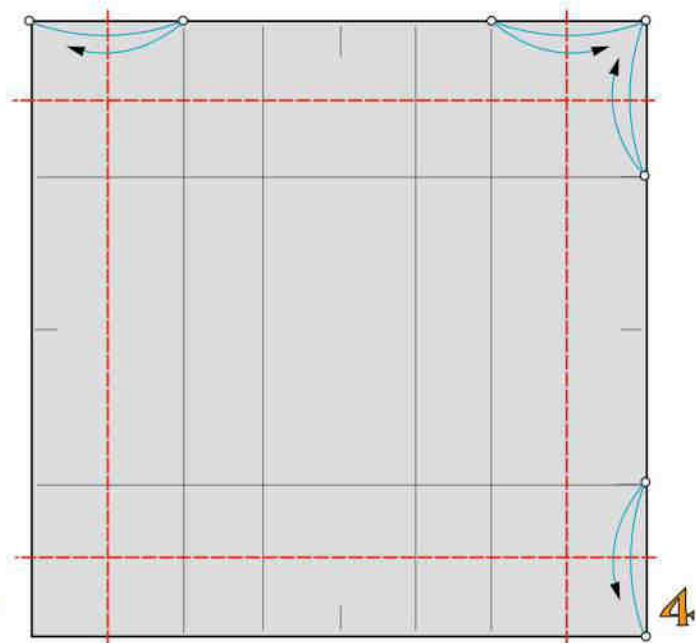

4 pieghe a valle

4

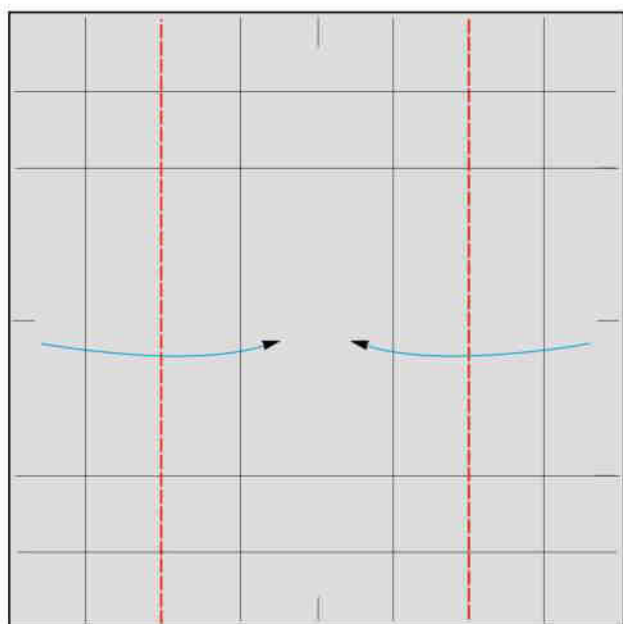

Ripiegate a valle

5

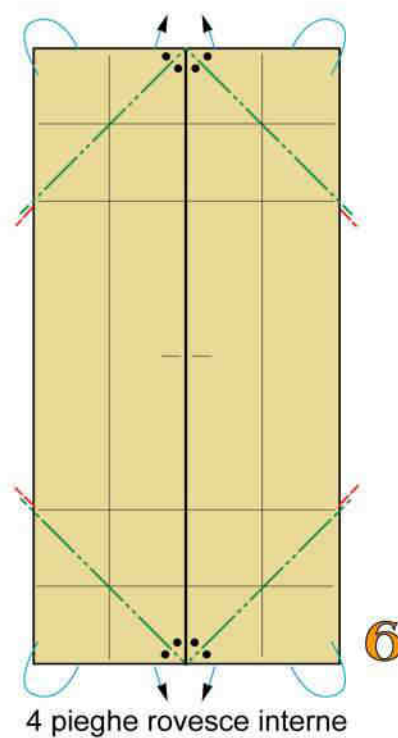

4 pieghe rovesce interne

6

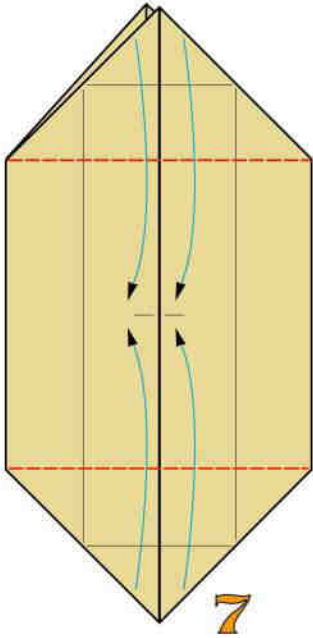

7

Ruotate i 4 vertici

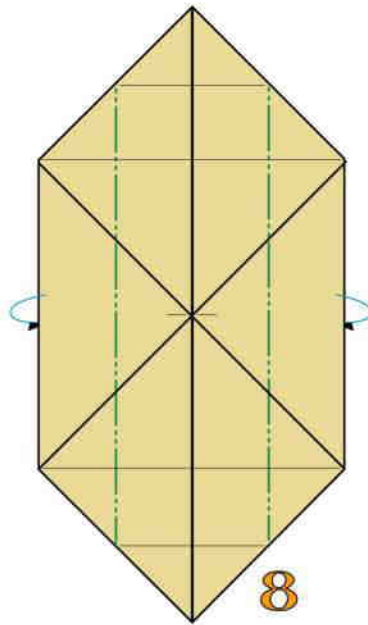

8

Ripiegate a monte

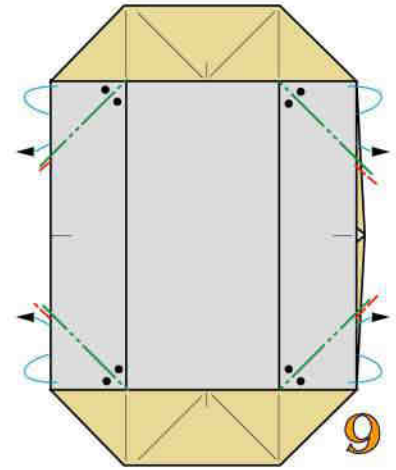

9

4 pieghe rovesce interne

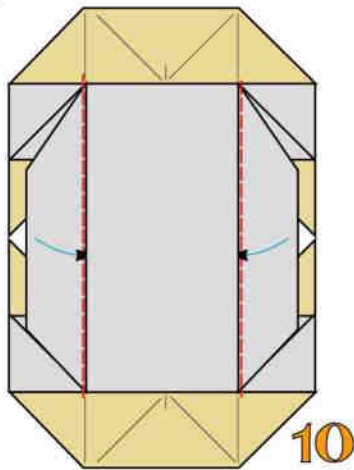

10

Mediante 2 pieghe a valle
intascate le 2 superfici

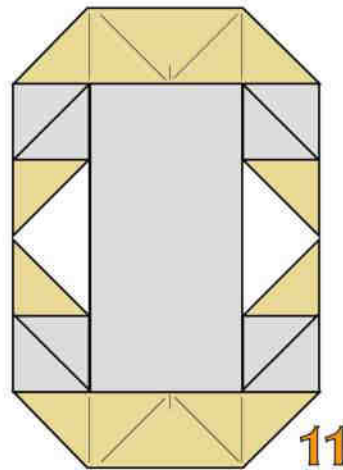

11

Modulo per nastri
"A" ultimato

COSTRUZIONE DEL MODULO DI COLLEGAMENTO "A"

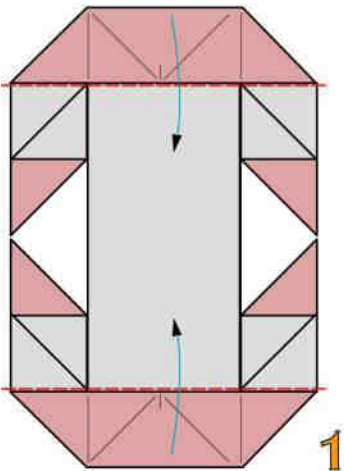

1

Partite dal modulo "A".
Ripiegate a valle

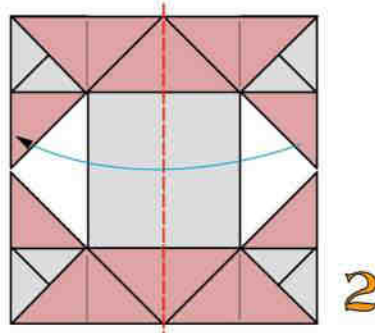

2

Ripiegate a monte

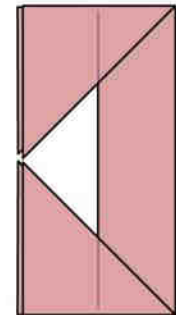

3

Modulo di collegamento
"A" ultimato

UNIONE DEI MODULI

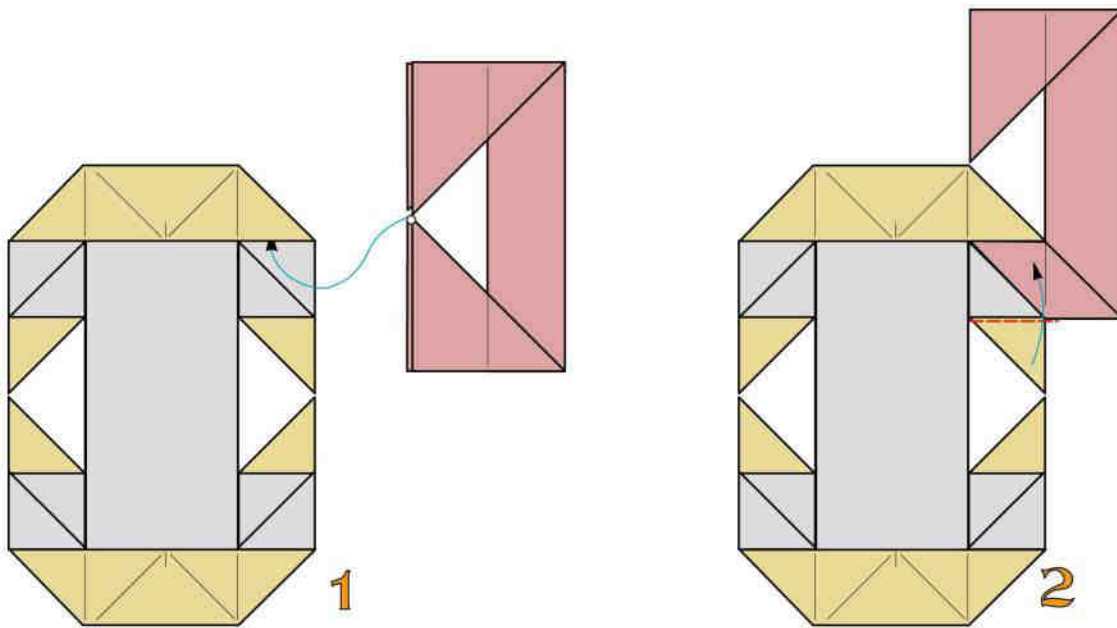

1
Intascate i 2 vertici sovrapposti del modulo di collegamento entro un modulo "A"

2
Ripiegate a valle nel modulo "A"

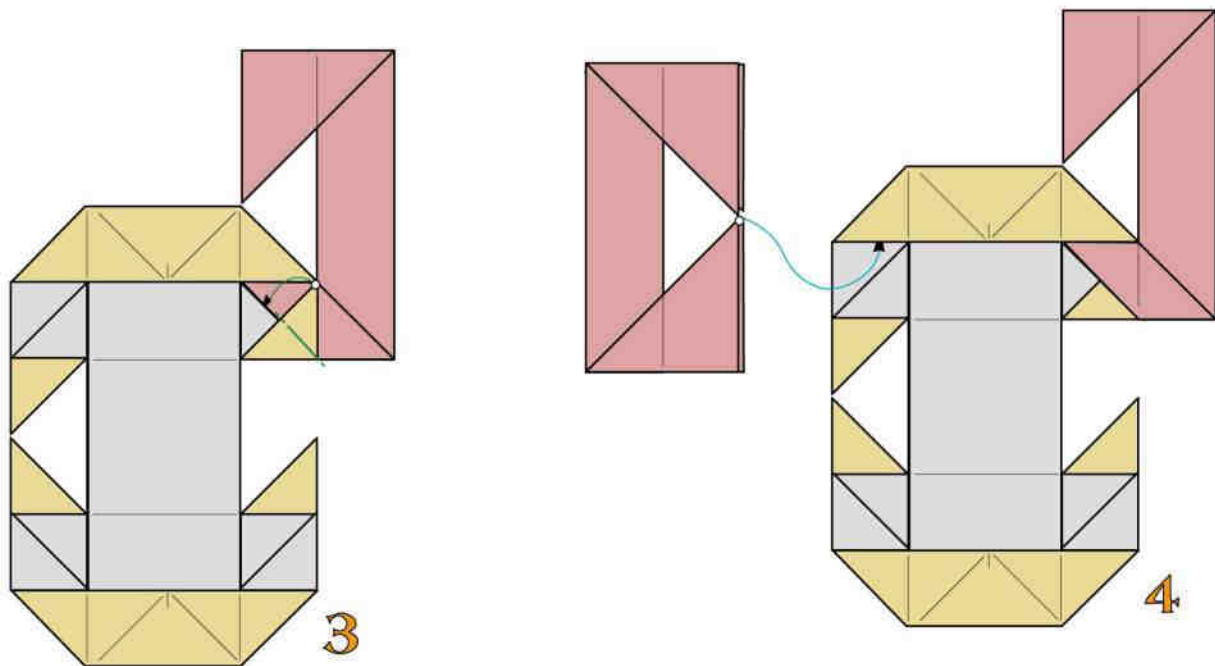

3
Mediante 1 piega a monte intascate bloccando l'unione

4
Nello stesso modo unite un altro modulo di collegamento

NASTRO "A1" TRAFORATO

Franco Pavarin 24

Secondo modello costruibile unendo moduli per nastro "A" e moduli di collegamento "A".
Adoperate carta monocolora di leggera delle dimensioni di cm 10x10

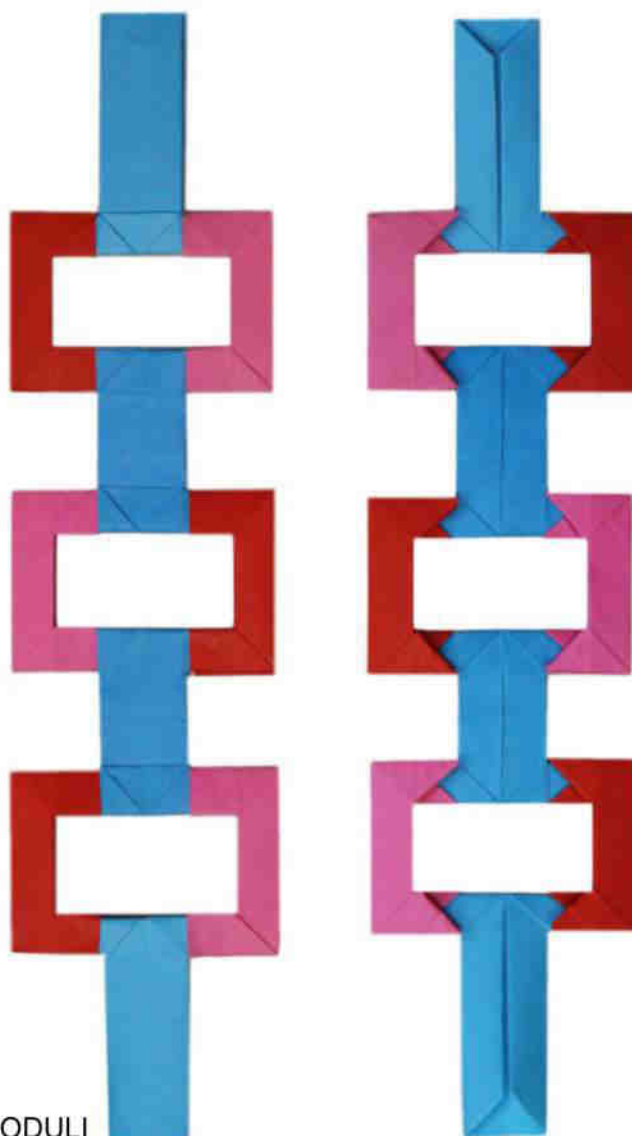

UNIONE DEI MODULI

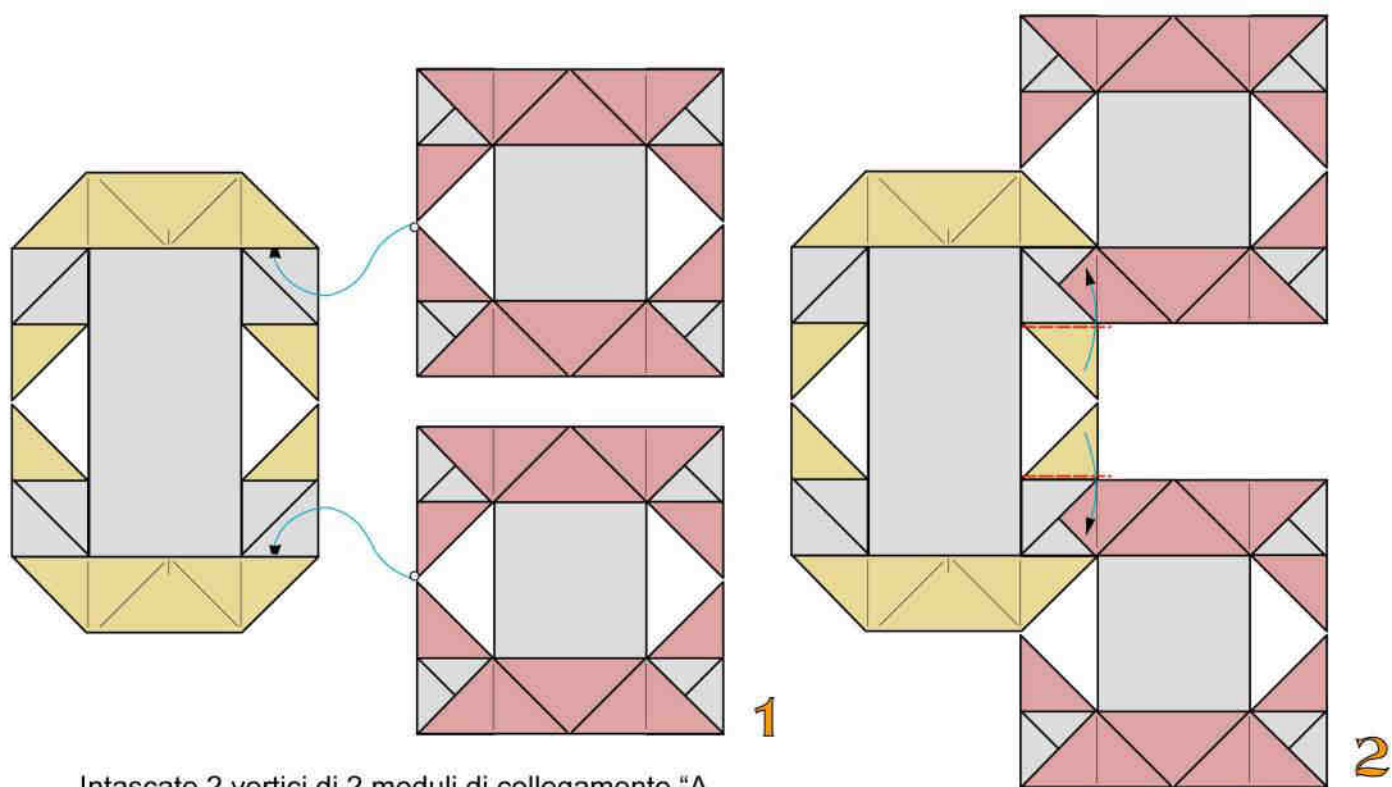

Intascate 2 vertici di 2 moduli di collegamento "A" in un modulo per nastri "A"

12

2 pieghe a valle

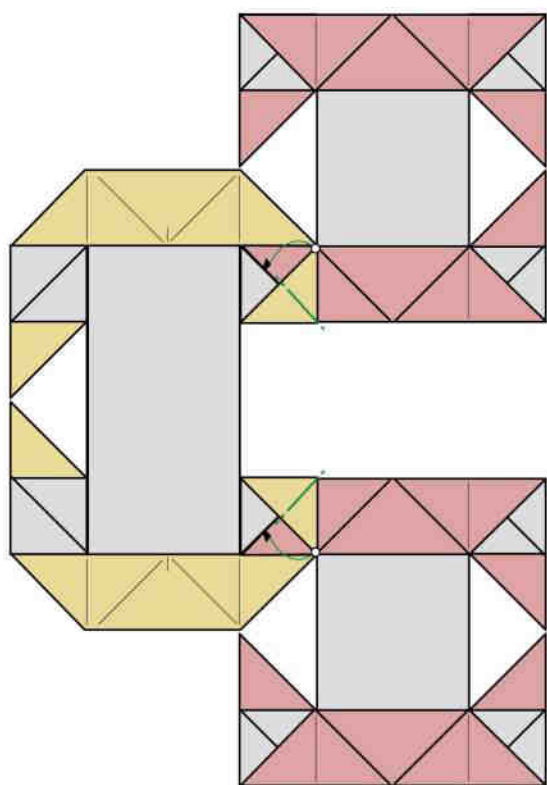

3

Mediante 2 pieghe a monte intascate bloccando l'unione

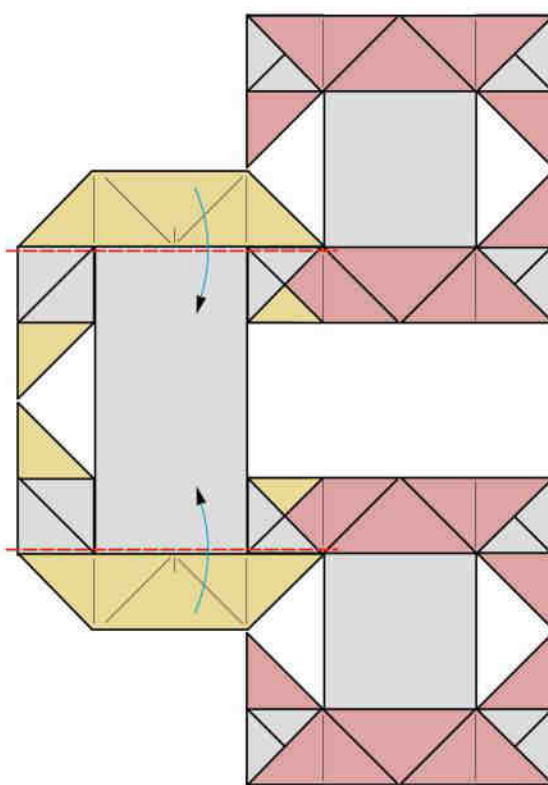

4

2 pieghe a valle

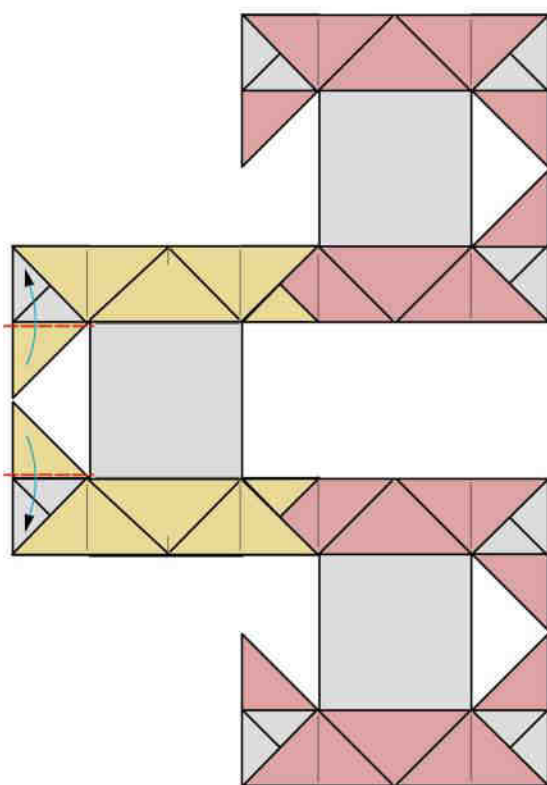

5

2 pieghe a valle

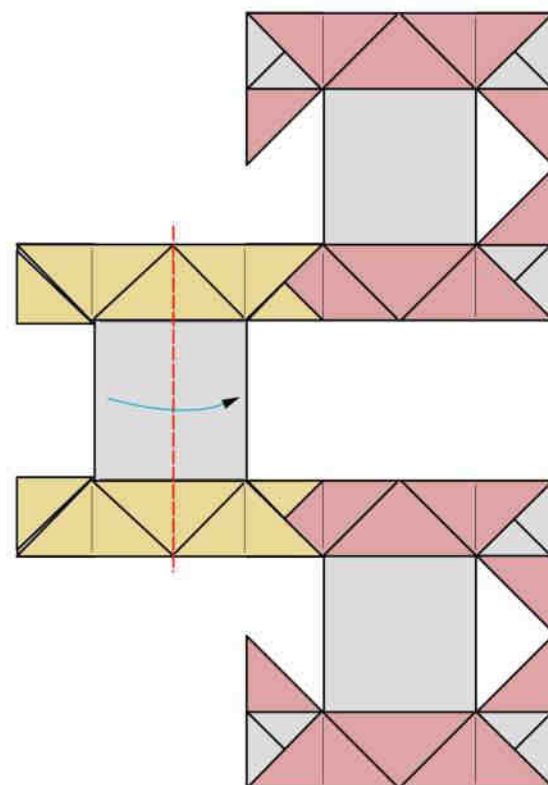

6

1 piega a valle

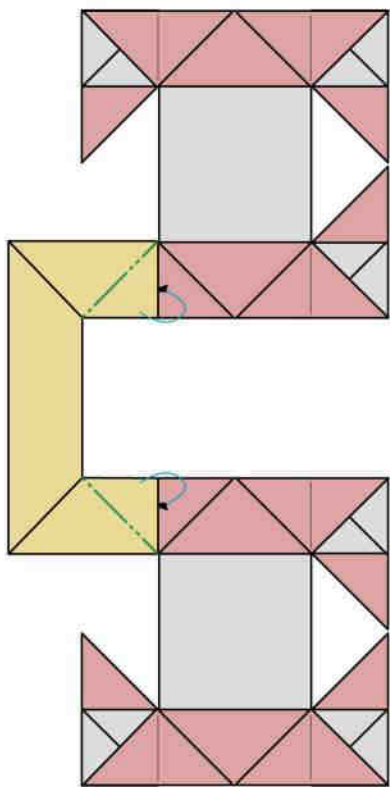

7

2 pieghe a monte e intascate

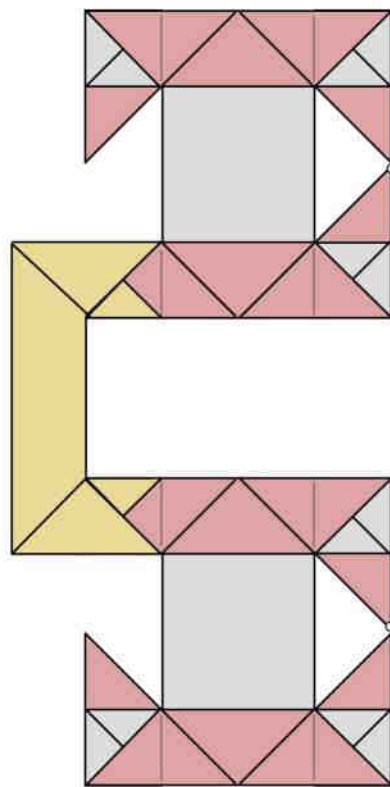

8

Ora potete aggiungere un altro modulo "A" che unirete nel solito modo

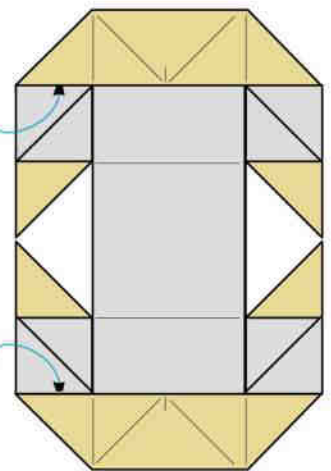

NASTRO "A2" TRAFORATO

Franco Pavarin 24

Si costruisce unendo moduli per nastro "A" modificati e moduli di collegamento "A" modificati.

Adoperate carta monocolore di leggera delle dimensioni di cm 10x10

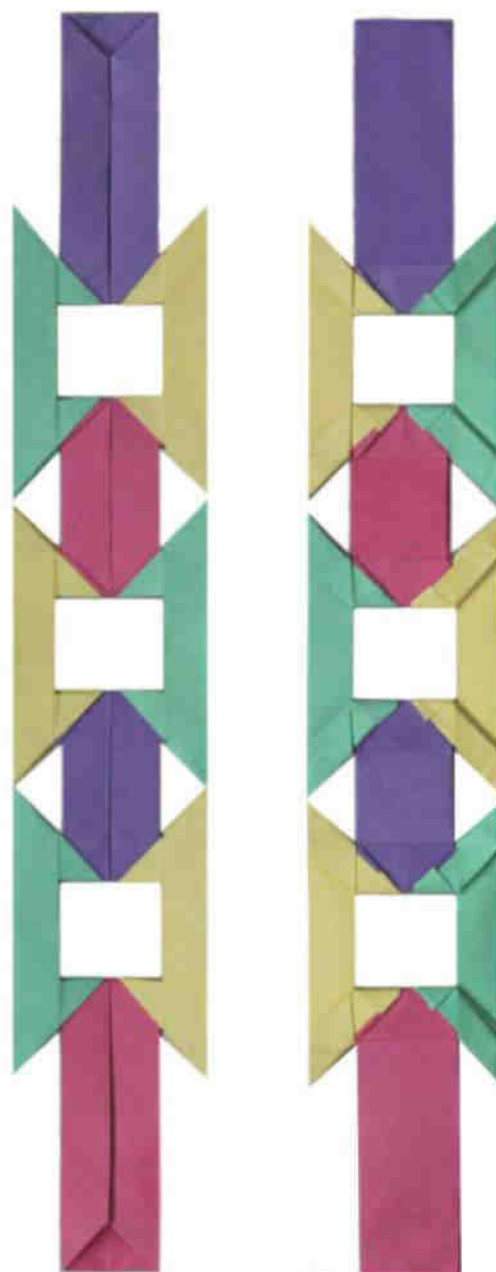

MODIFICA DEL MODULO PER NASTRI "A"

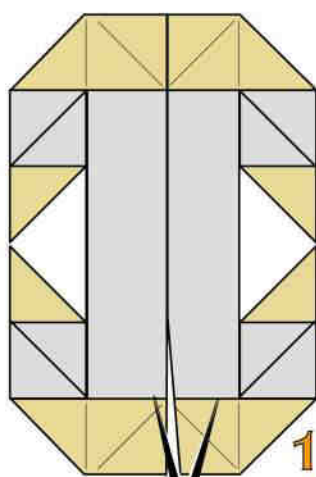

1

Dividete il modulo "A" in 2 parti uguali

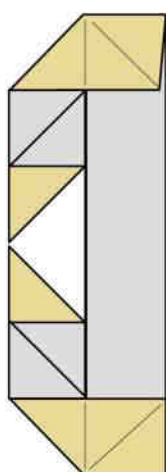

2

Ribaltate



3

2 pieghe a valle

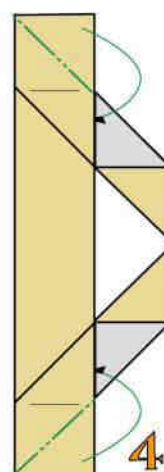

4

2 pieghe a monte e intascate

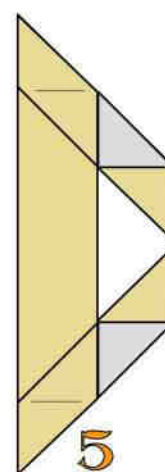

5

Semimodulo "A" modificato

MODIFICA DEL MODULO DI COLLEGAMENTO "A"

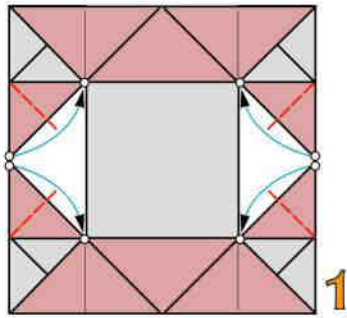

4 pieghe a valle

1

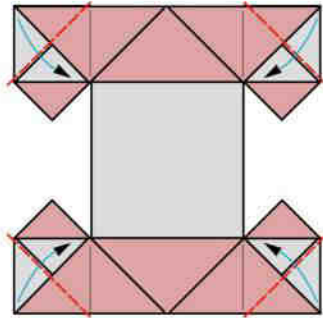

4 pieghe a valle

2

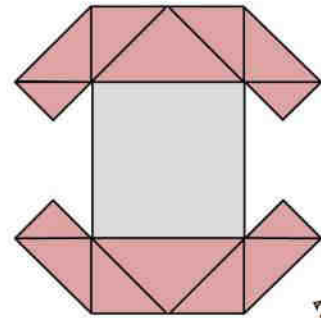

Modulo di collegamento "A" modificato

3

UNIONE DEI MODULI

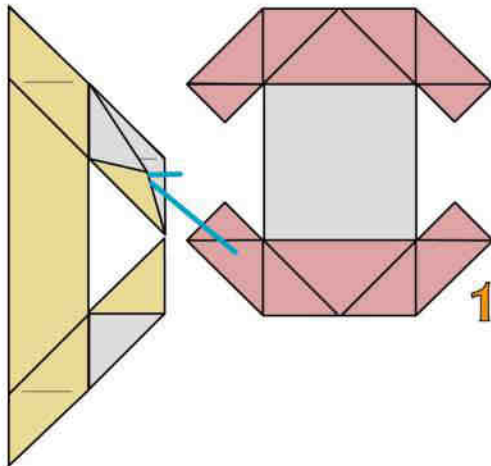

Intascate un modulo di collegamento "A" modificato entro un modulo "A" modificato

1

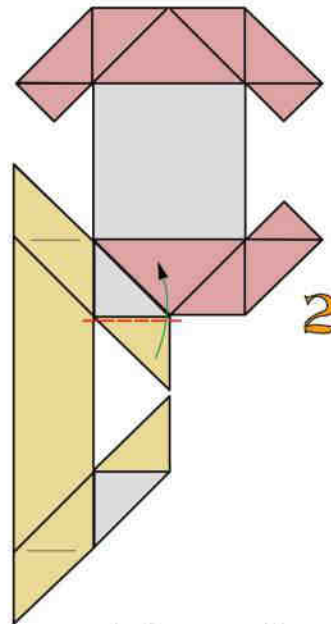

1 piega a valle

2

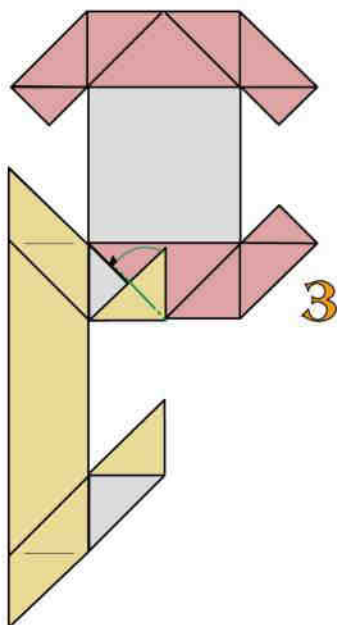

Mediante 1 piega a monte intascate bloccando l'unione

3

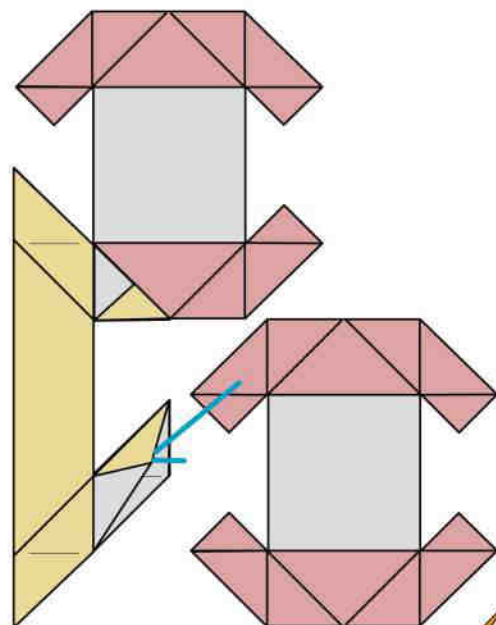

Nello stesso modo unite un altro modulo di collegamento modificato

4

NASTRO TRAFORATO "A3"

Franco Pavarin 24

Si costruisce unendo moduli per nastro "A3" e moduli di collegamento "A3".
Adoperare carta monocolora di medio peso delle dimensioni di cm 10x10

COSTRUZIONE DEL MODULO PER NASTRO "A3"

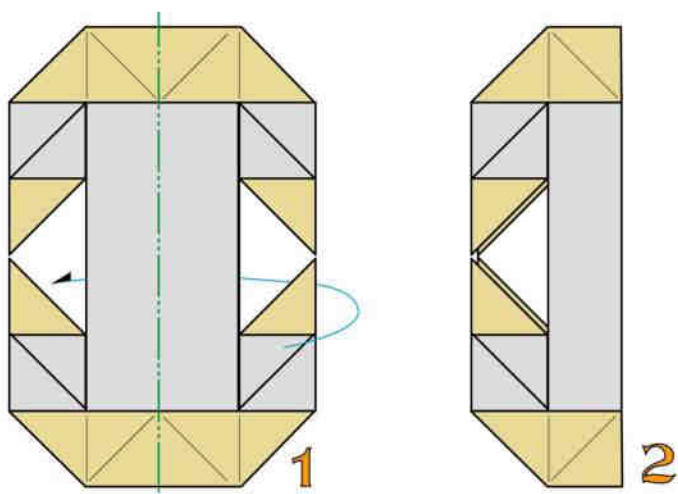

Partite da un modulo per nastri "A".
1 piega a monte

Modulo per nastri "A3" ultimato

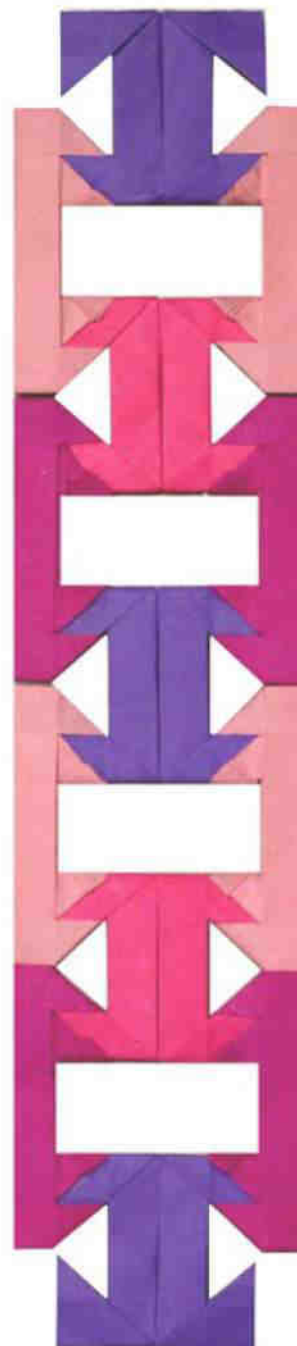

COSTRUZIONE DEL MODULO DI COLLEGAMENTO "A3"

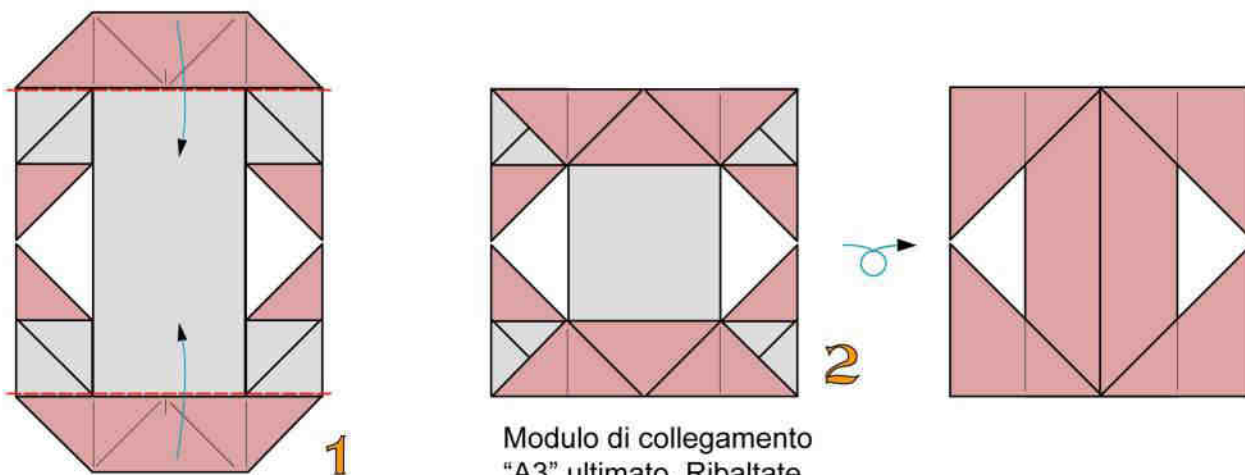

Partite dal modulo "A".
Ripiegate a valle

Modulo di collegamento "A3" ultimato. Ribaltate

UNIONE DEI MODULI

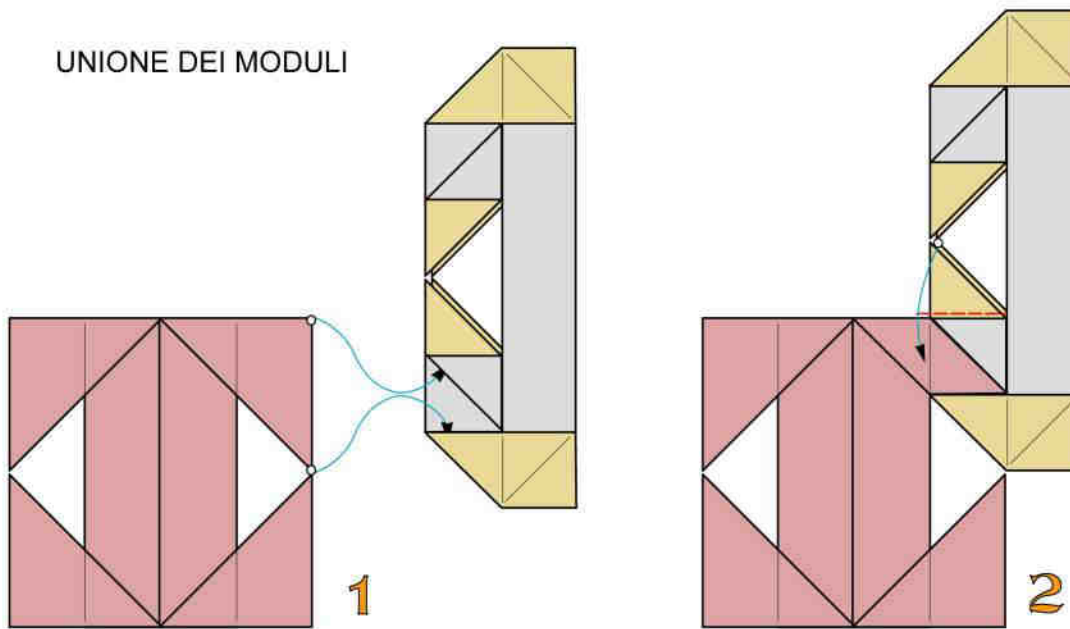

Intascate 2 vertici del modulo di collegamento "A3" entro un modulo "A3"

Piegate a valle ambedue i vertici

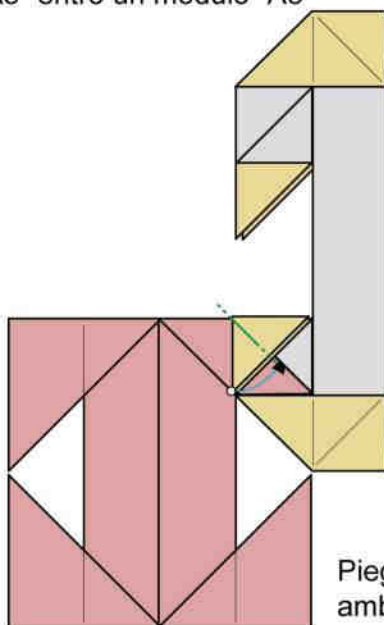

Piegando a monte intascate ambedue i vertici

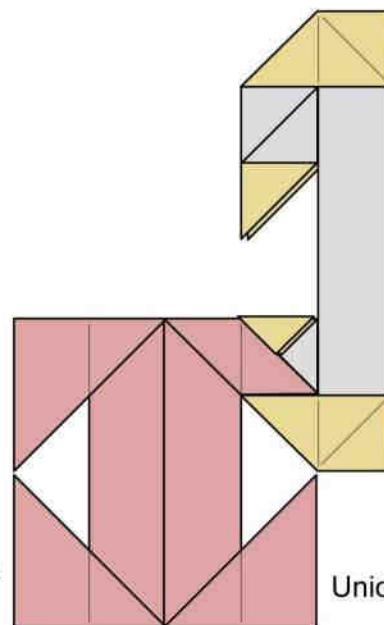

Unione dei moduli ultimata

Aggiungete un alto modulo "A3" e procedete nel solito modo

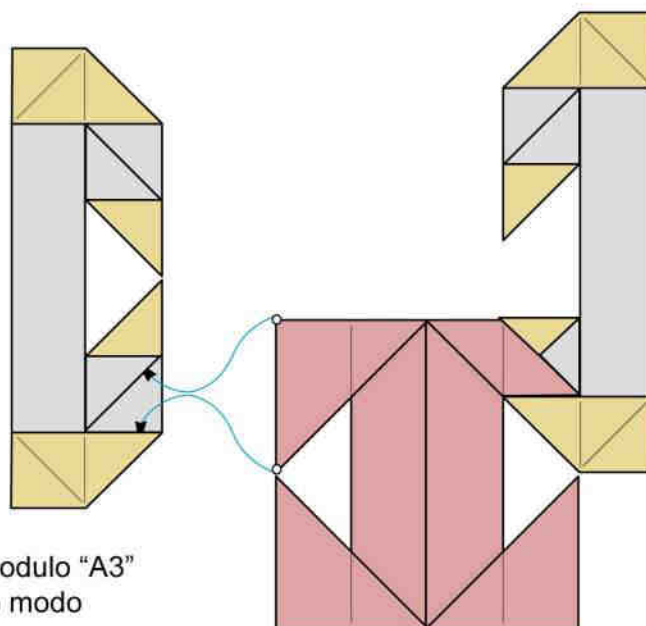

NASTRO MODULARE "A4"

Franco Pavarin 24

Si costruisce unendo 2 tipi di moduli.
Adoperate fogli monocolori di medio
peso delle dimensioni di cm 7,5x7,5

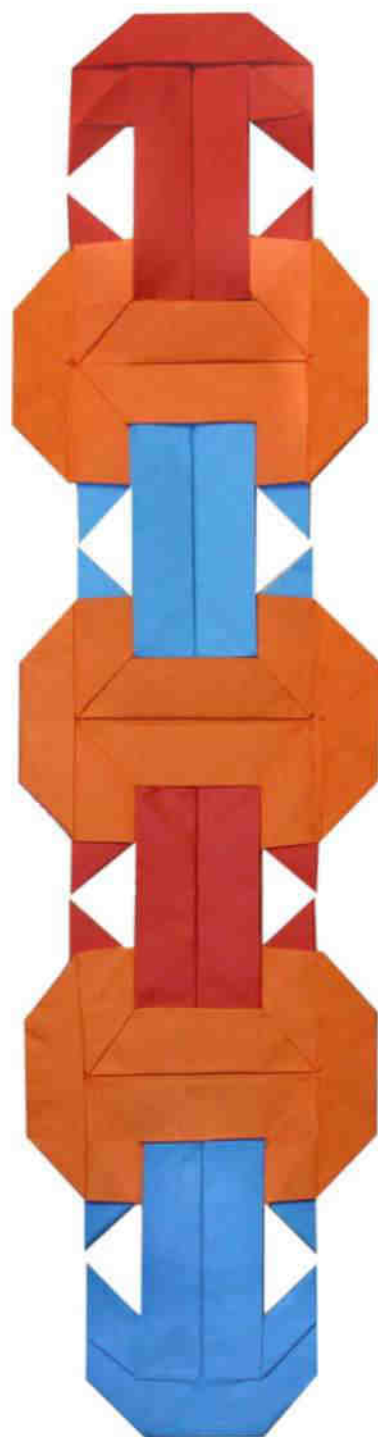

UNIONE DEI MODULI

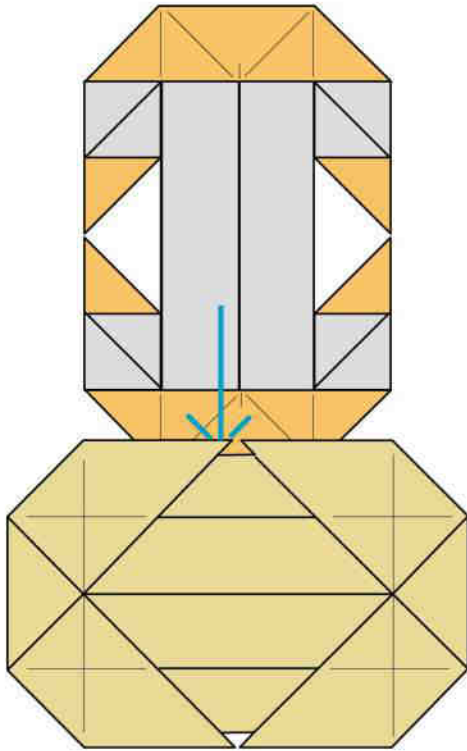

Inserite un modulo per nastri "E"
in un modulo per nastri "A"

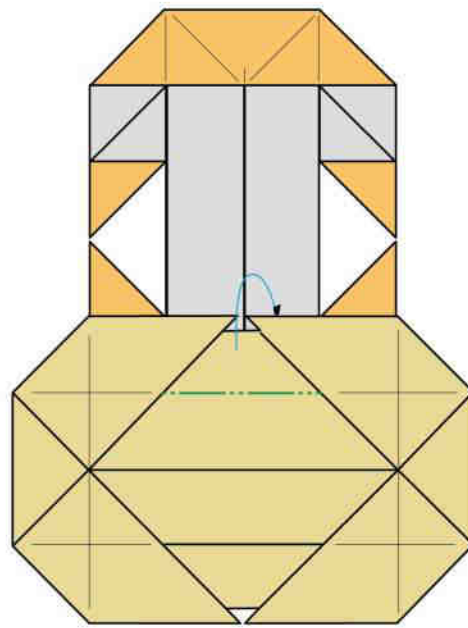

Ripiegando a monte intascate
bloccando l'unione

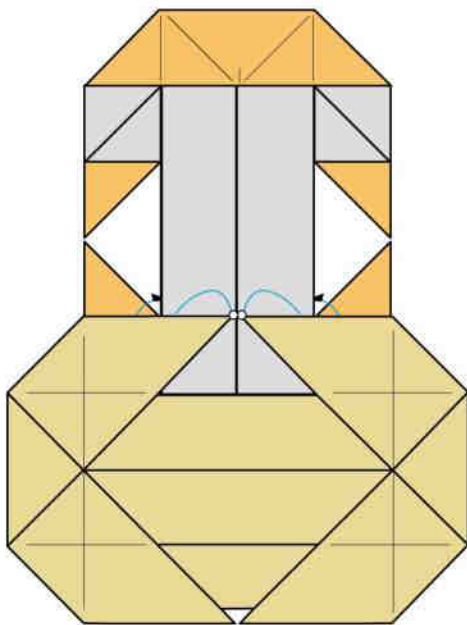

Intascate inferiormente i 2 vertici indicati

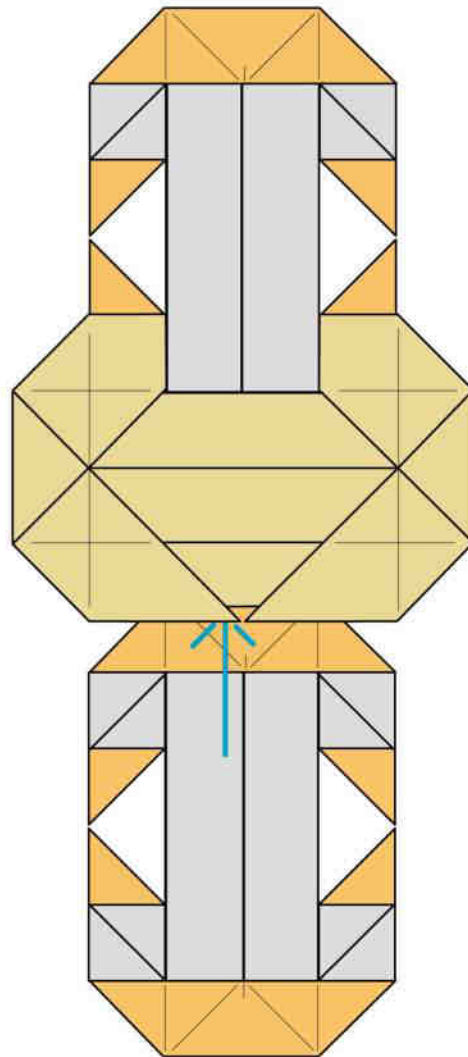

Unione di 2 moduli ultimata.
Proseguite aggiungendo altri moduli

UNIONE DEI MODULI

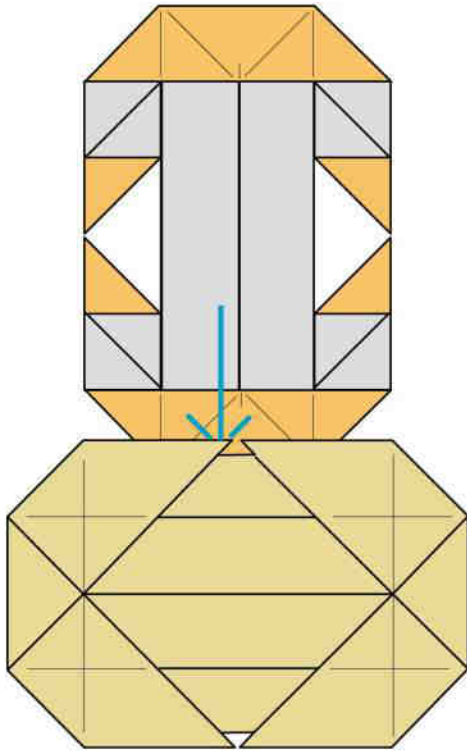

Inserite un modulo per nastri "E"
in un modulo per nastri "A"

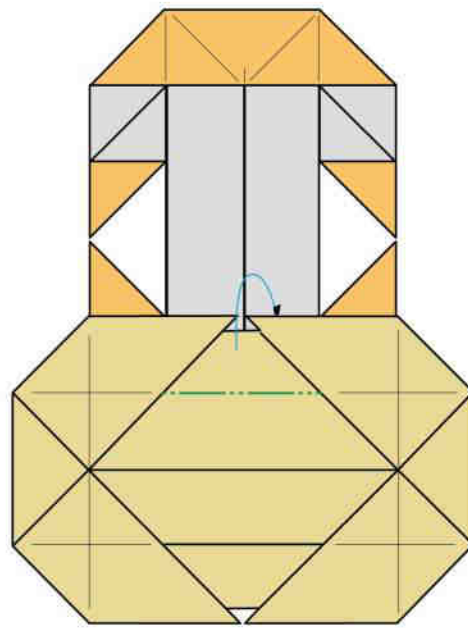

Ripiegando a monte intascate
bloccando l'unione

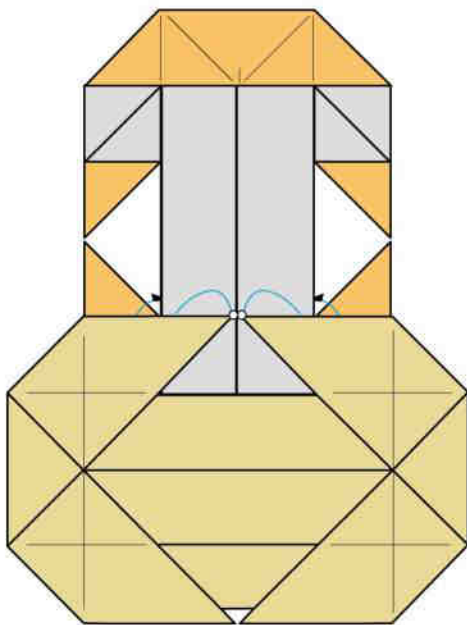

Intascate inferiormente i 2 vertici indicati

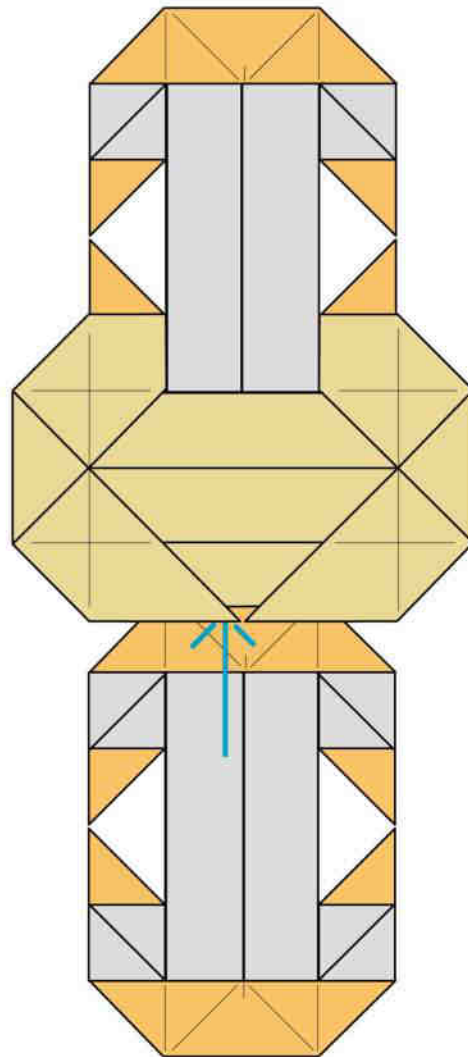

Unione di 2 moduli ultimata.
Proseguite aggiungendo altri moduli

NASTRO "B"

Franco Pavarin 24

Per costruire i moduli adoperate carta monocolora di medio peso delle dimensioni di cm 8x8

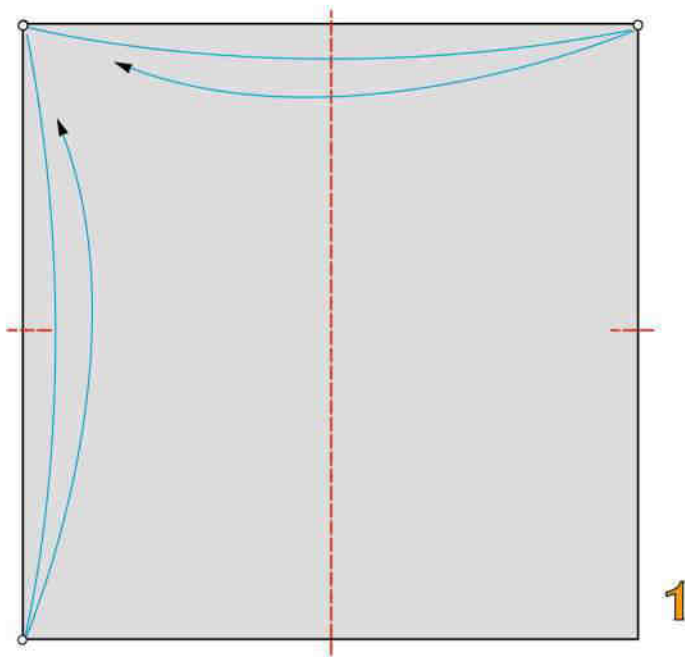

3 pieghe a valle, di cui 2 piccole

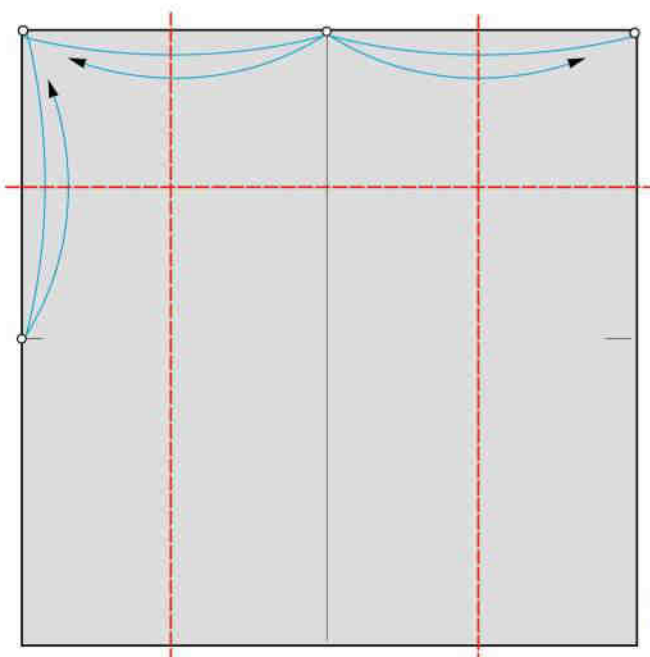

3 pieghe a valle, di cui 2 piccole

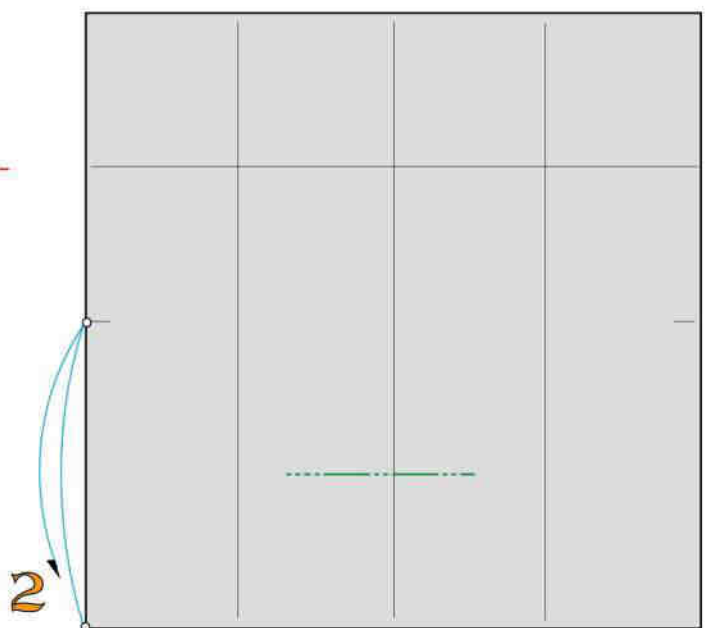

1 piega a monte

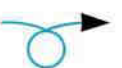
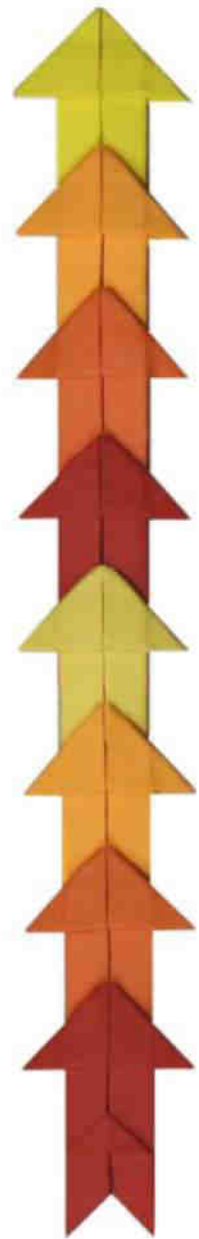

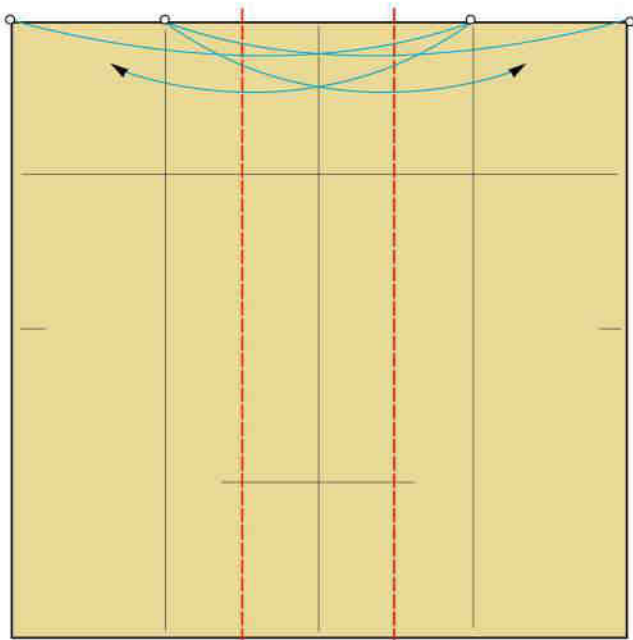

4

2 pieghe a valle

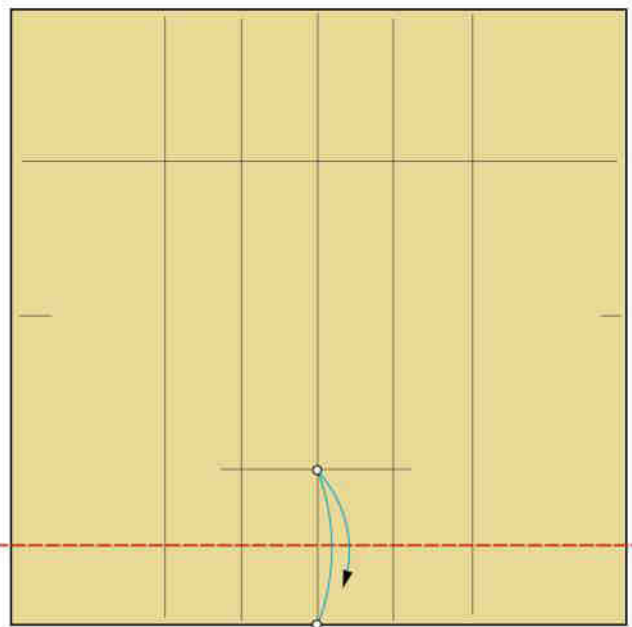

5

1 piega a valle

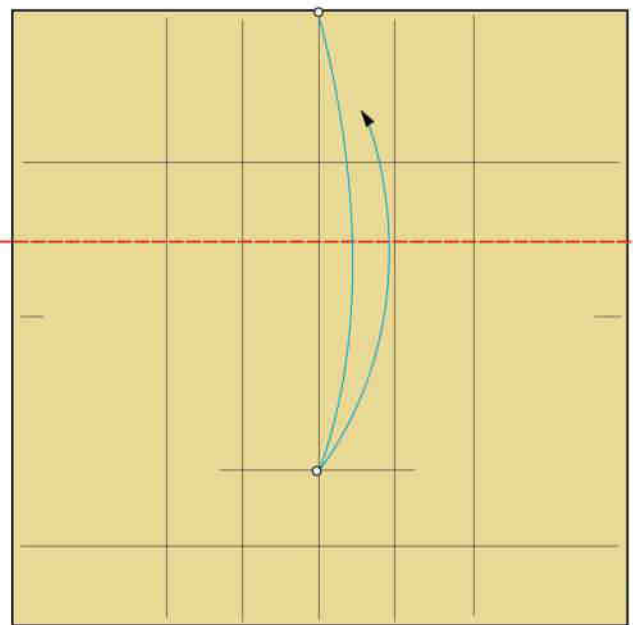

6

1 piega a valle

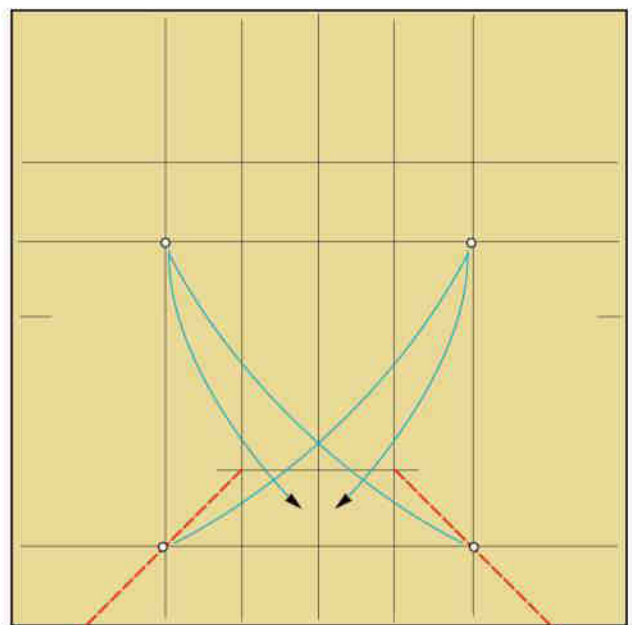

7

2 pieghe a valle

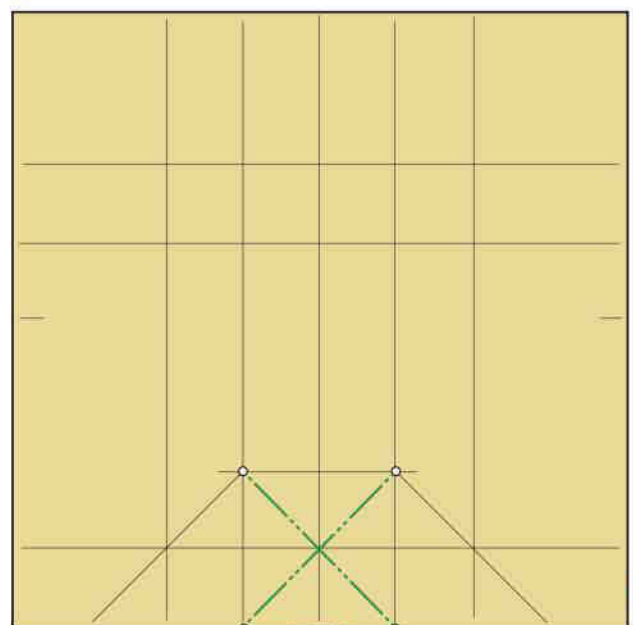

8

2 pieghe a monte

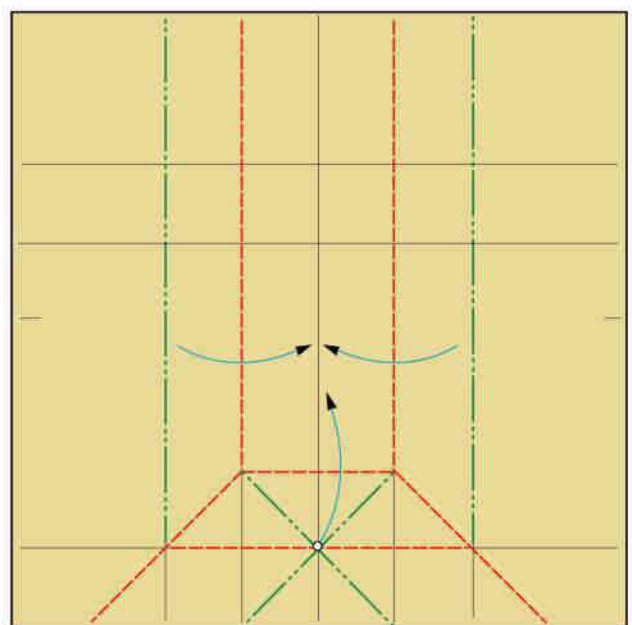

9

Ripiegate a valle e a monte

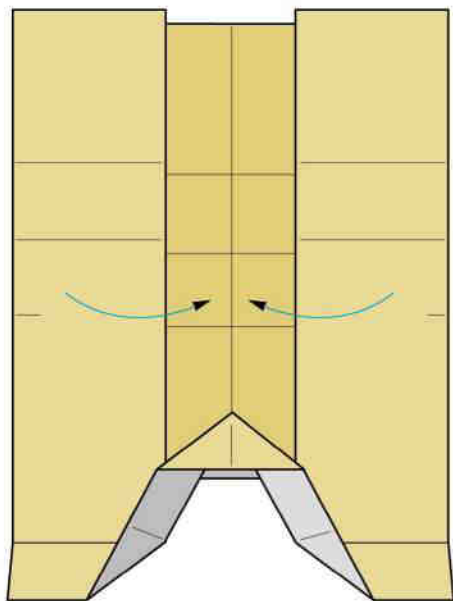

10

Richiudete

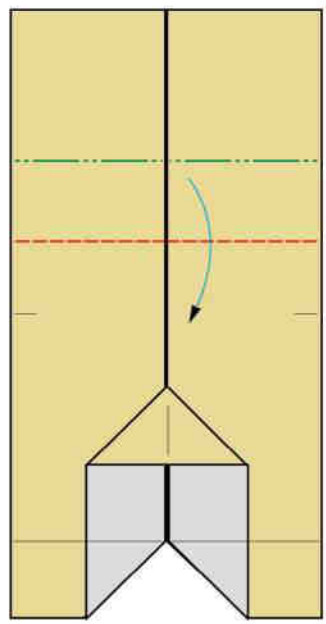

11

Ripiegate a valle e a monte

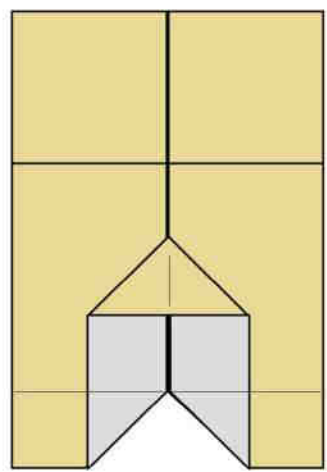

12

Ribaltate

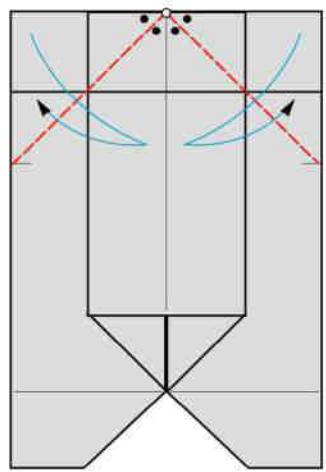

13

2 pieghe bisettrici a valle

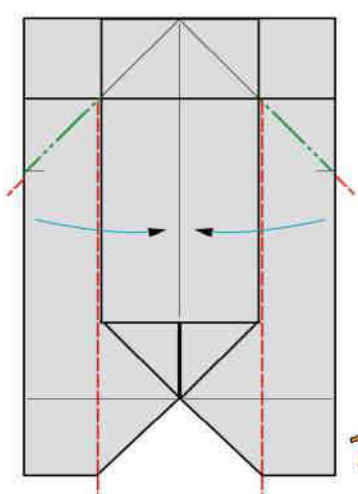

14

Ripiegate a valle e a monte

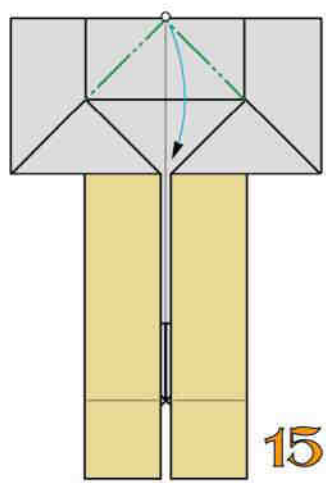

15

2 pieghe a monte

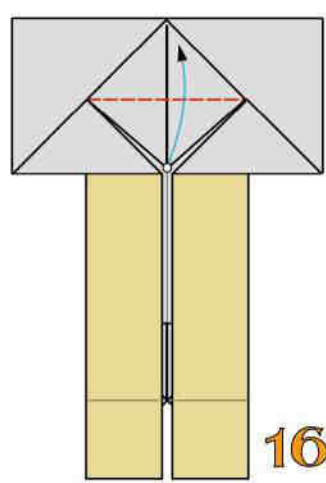

16

Ripiegate a valle

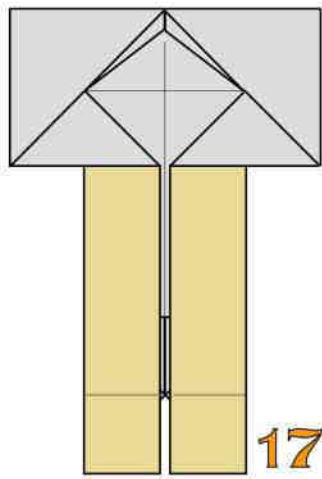

17

Ribaltate

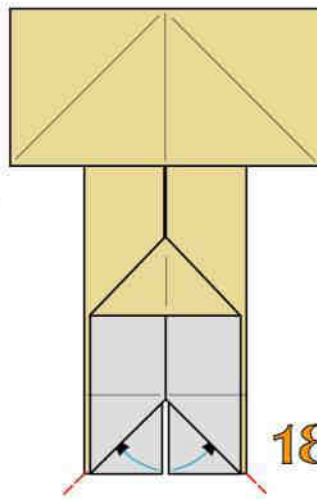

18

2 pieghe a valle e intascate

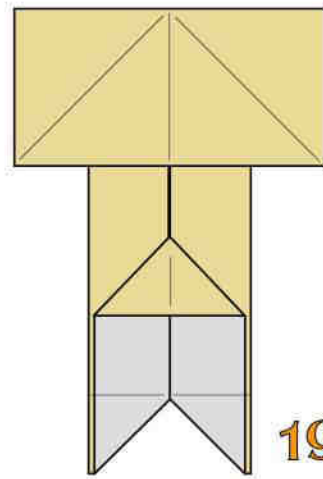

19

Modulo per nastri "B"
ultimato

UNIONE DEI MODULI

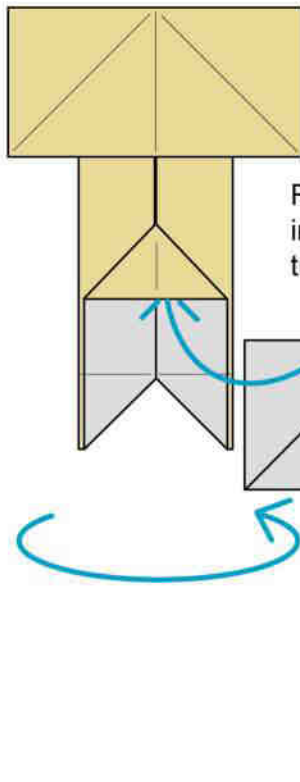

Ribaltate un modulo sull'altro
inserendo il vertice nella tasca
triangolare

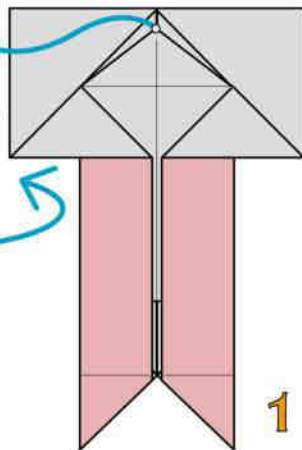

1

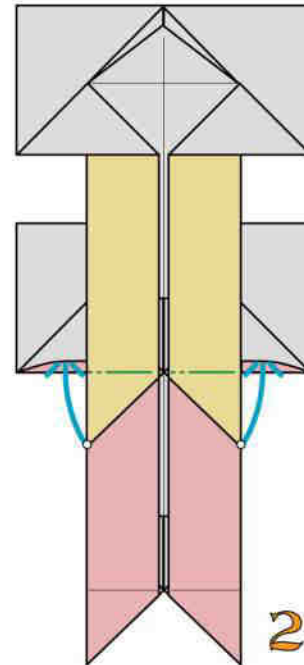

Ripiegando a monte
intascate i vertici

2

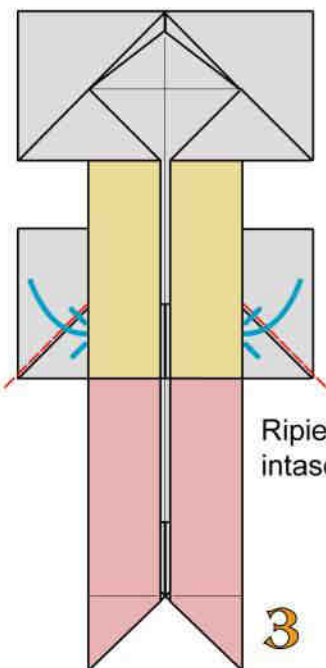

Ripiegando a valle
intascate i triangoli

3

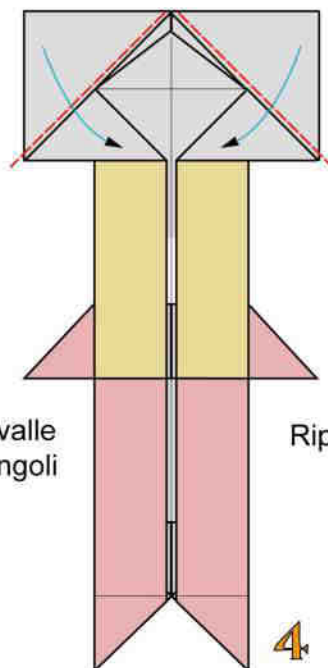

4

Ripiegate a valle

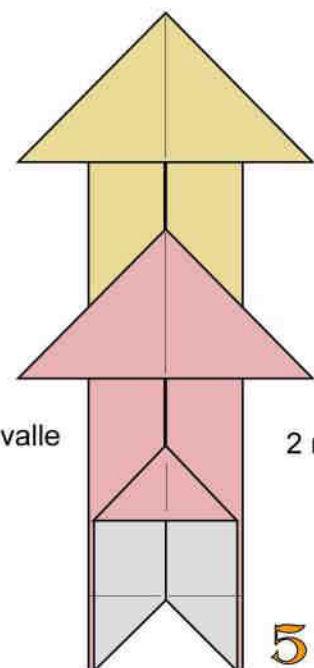

5

2 moduli uniti

NASTRO MULTIFORME

I 4 tipi di moduli disegnati permettono la realizzazione di modelli di varia forma. Il braccialetto del cuore è stato realizzato con 10 moduli uguali ricavati da fogli monocolori di medio peso di dimensioni cm 6x6.

La cornice è stata realizzata con 16 moduli di 3 tipi differenti ricavati da fogli monocolori di medio peso di dimensioni cm 10x10.

The 4 types of modules designed allow the creation of models of various shapes.

The heart bracelet was made

with 10 identical modules obtained from medium-weight single-colour sheets measuring 6x6 cm.

The frame was made with 16

modules of 3 different types obtained from medium-weight single-colour sheets measuring 10x10 cm.

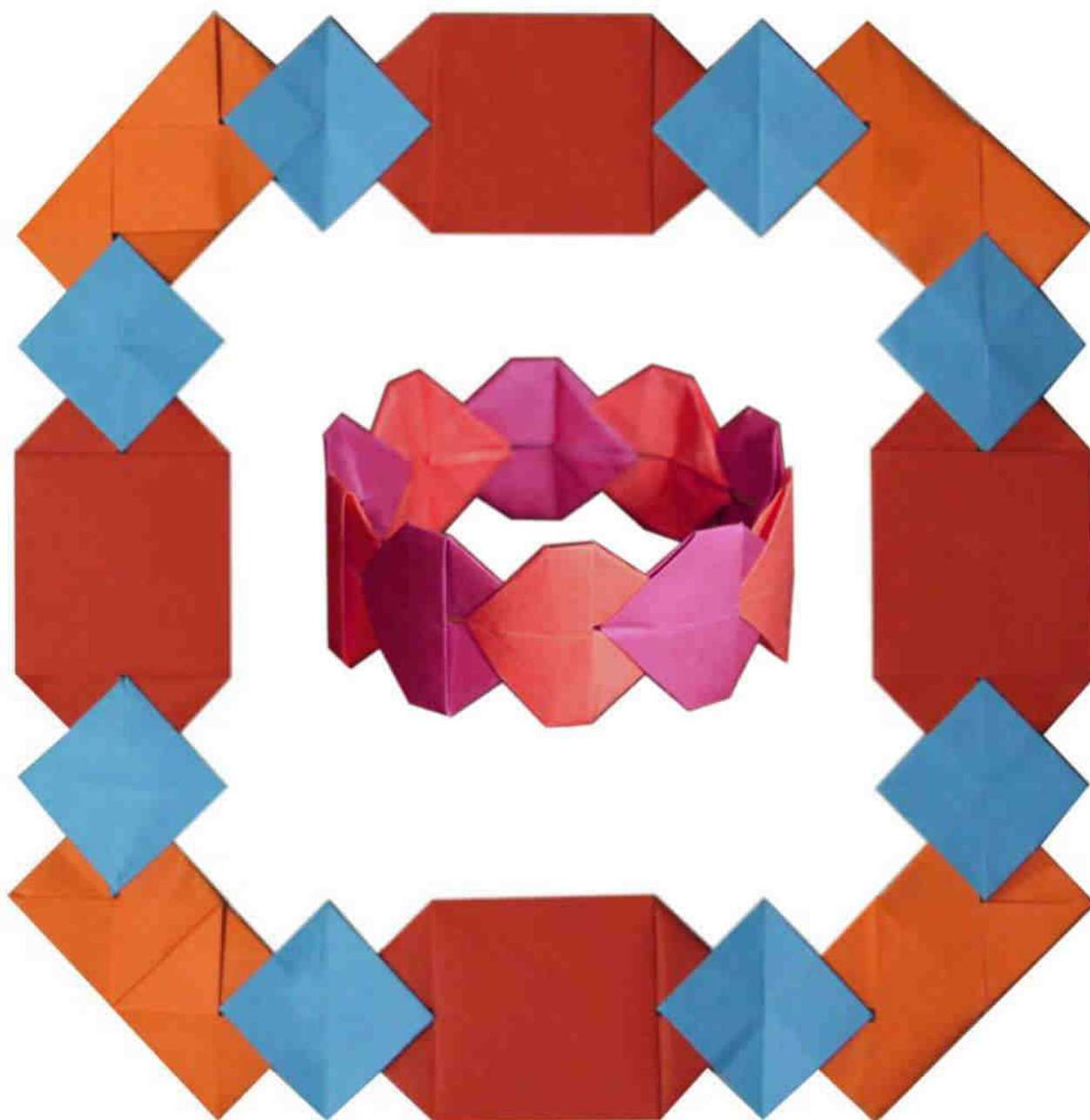

MODULO PER NASTRI ESAGONALE CON 4 TASCHE

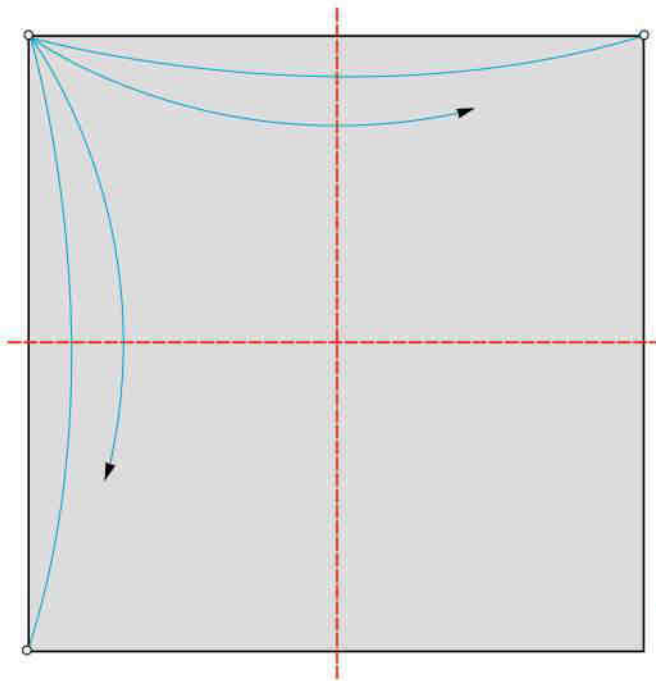

2 pieghe a valle

1

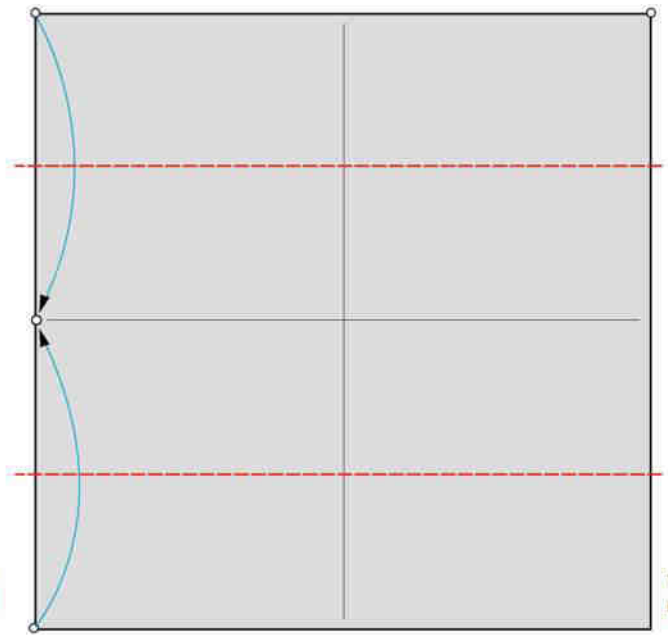

2 pieghe a valle

2

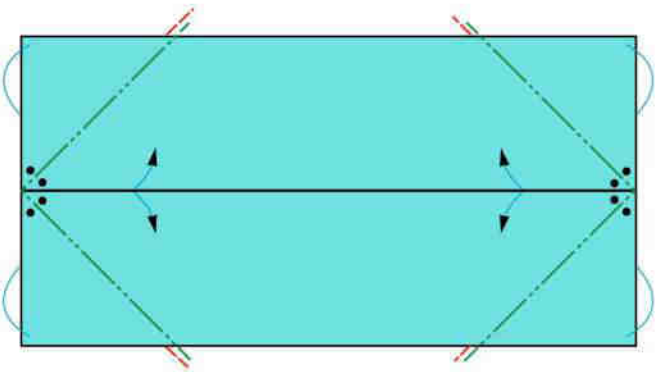

2 pieghe rovesce interne

3

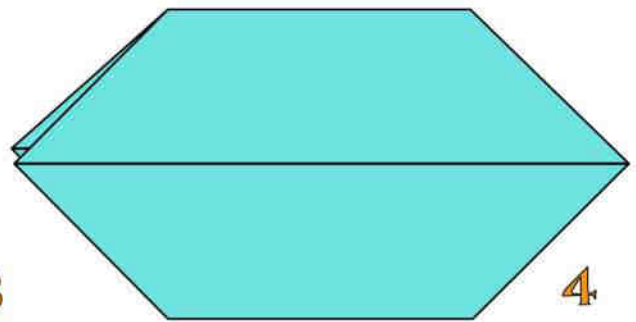

Ribaltate

4

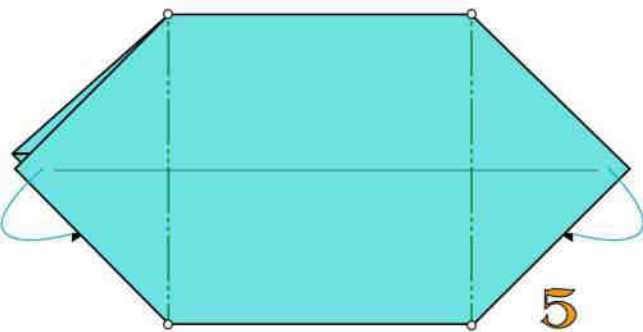

2 pieghe rovesce interne

5

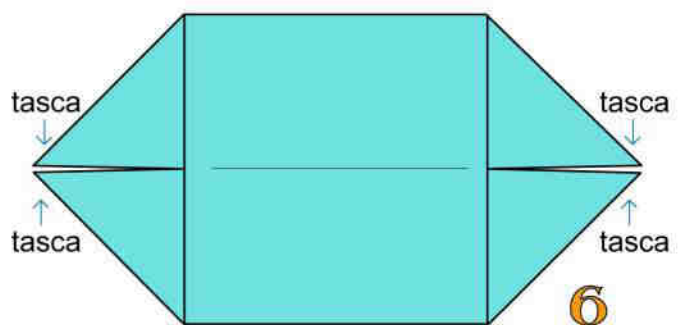

Modulo per nastri esagonale ultimato

6

MODULO PER NASTRI RETTANGONALE CON 4 TASCHE

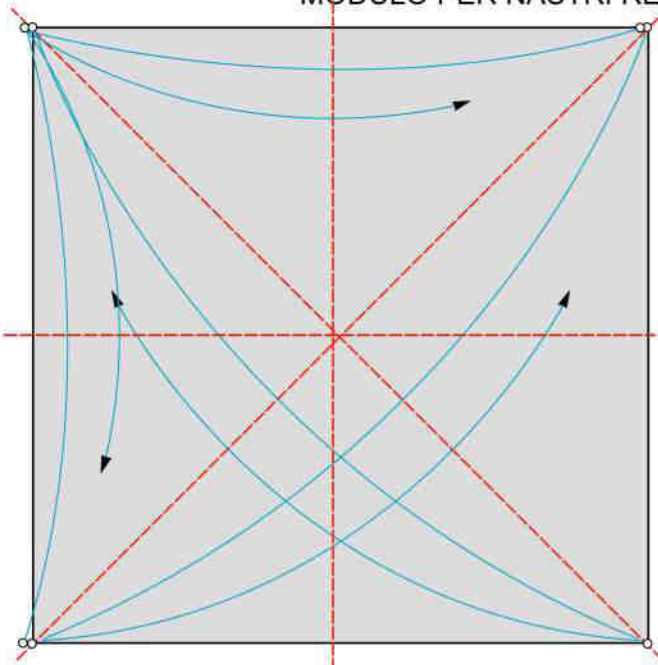

2 pieghe diagonali a valle

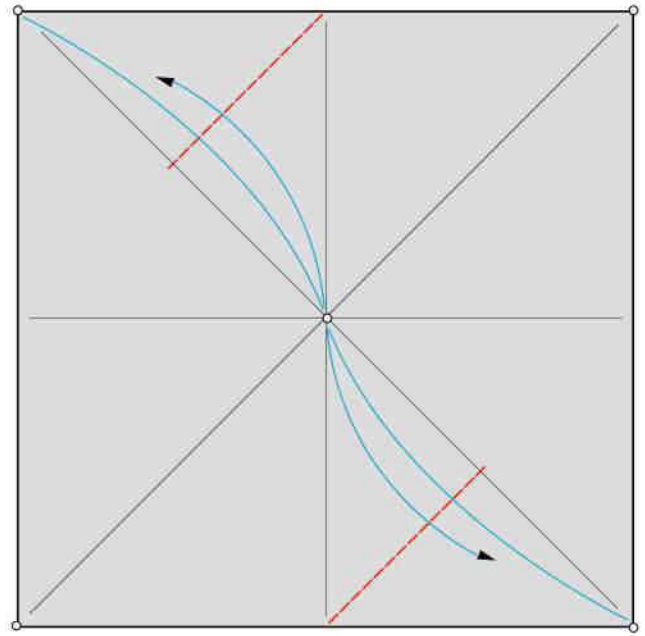

2 pieghe a valle

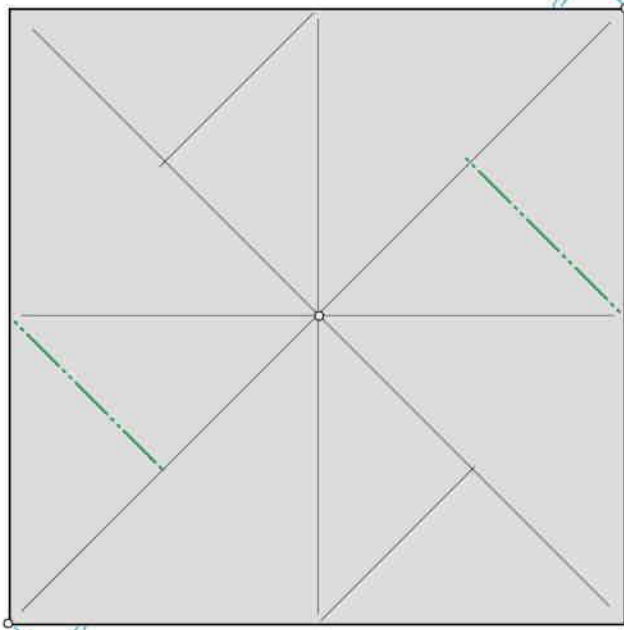

2 pieghe a monte

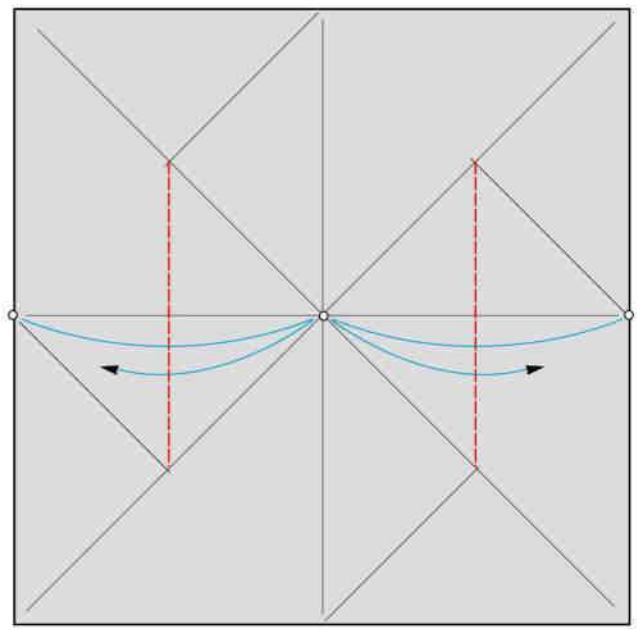

2 pieghe a valle

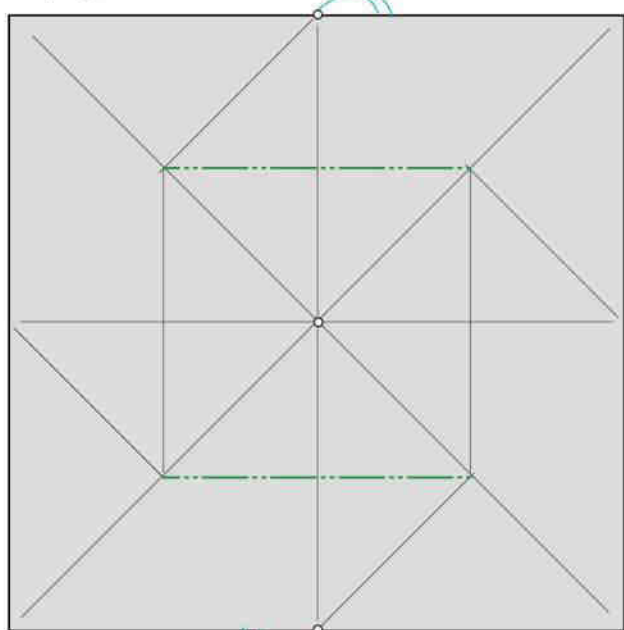

2 pieghe a monte

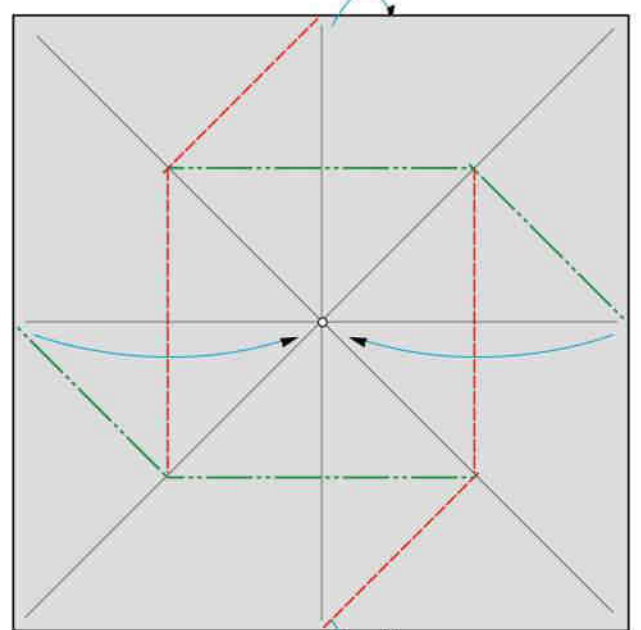

Ripiegare a valle e a monte

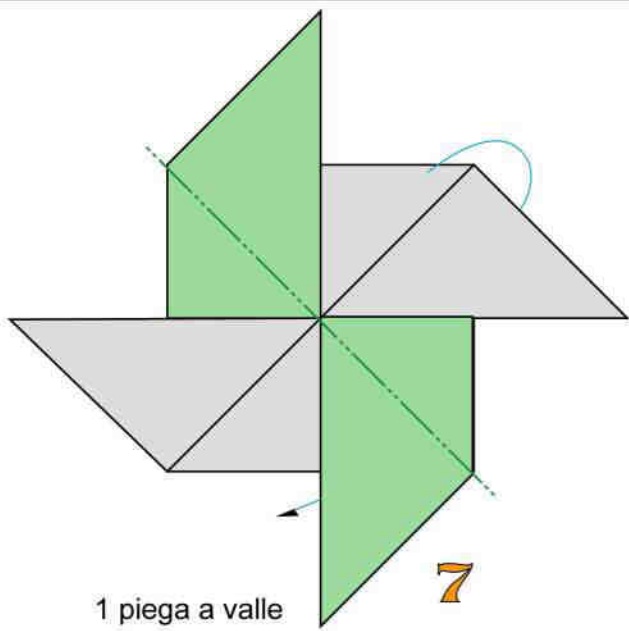

1 piega a valle

7

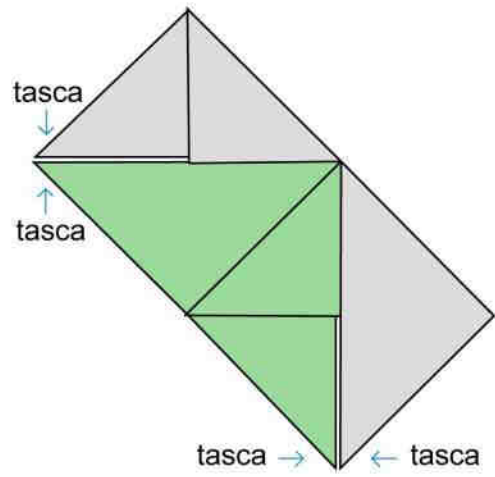

Modulo per nastri ortogonale ultimato

MODULO PER NASTRI QUADRATO CON 4 GANCI

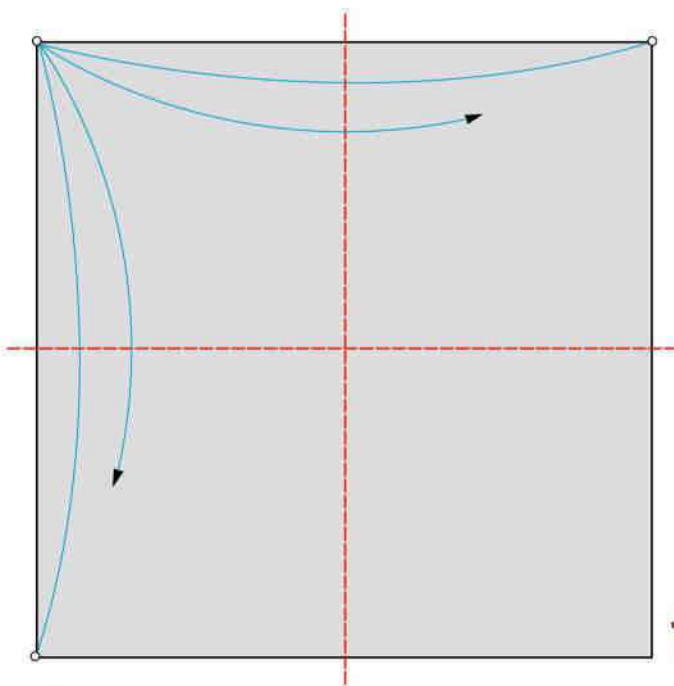

2 pieghe a valle

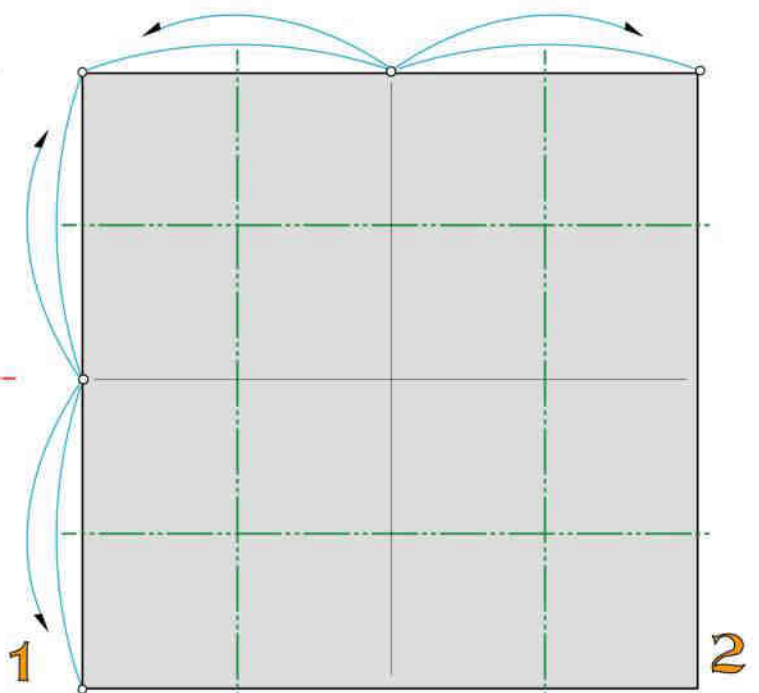

4 pieghe a monte

1

2

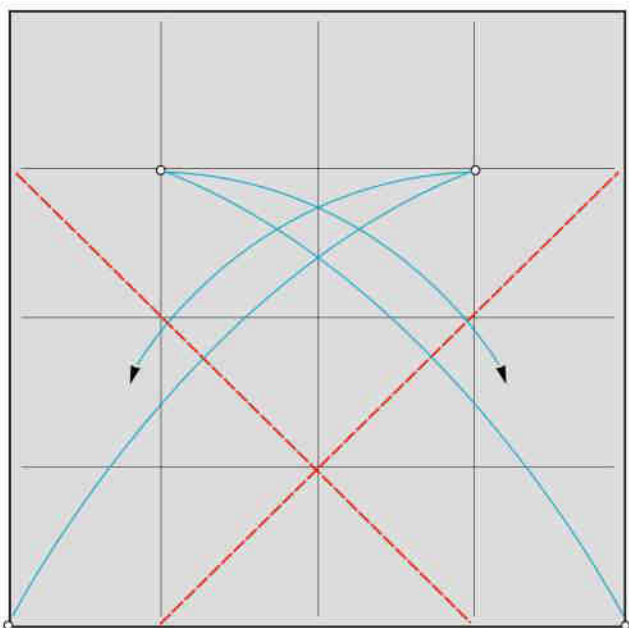

2 pieghe diagonali a valle

3

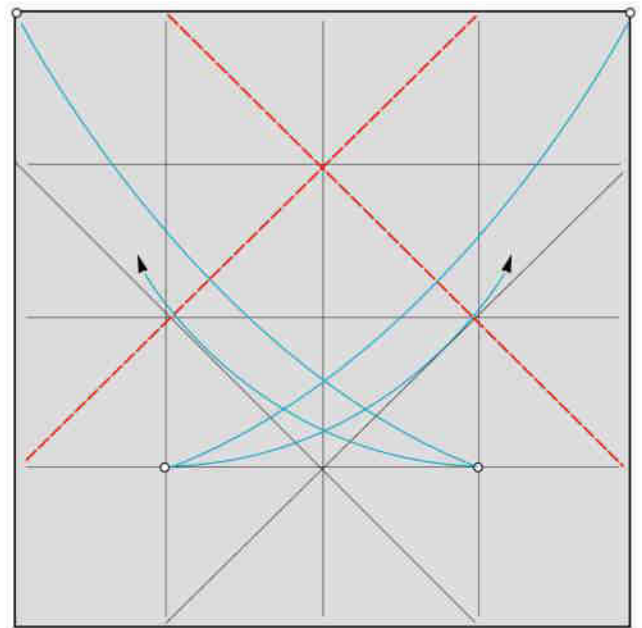

2 pieghe diagonali a valle

4

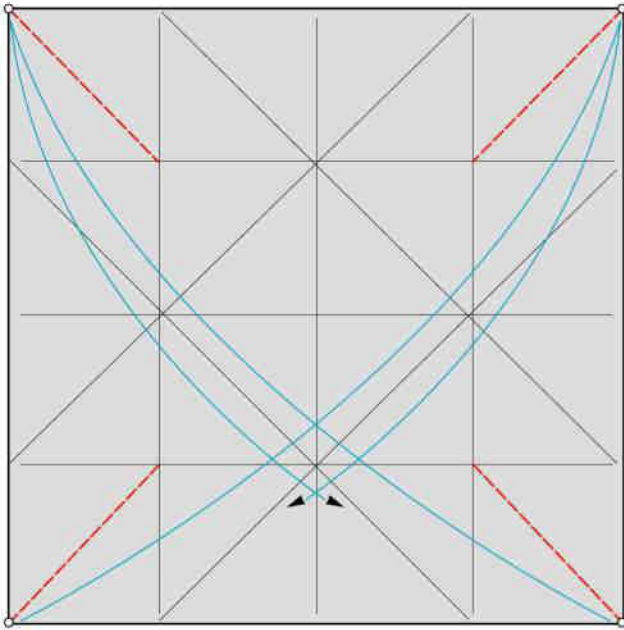

4 pieghe diagonali a valle

5

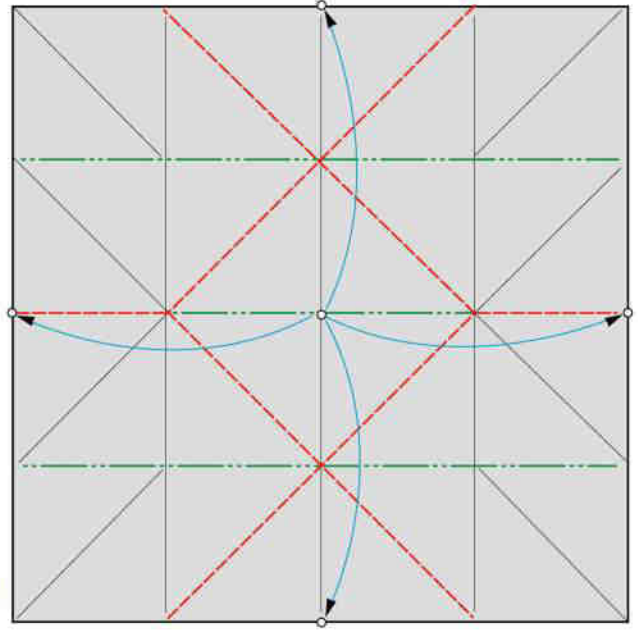

Ripiegate a valle e a monte

6

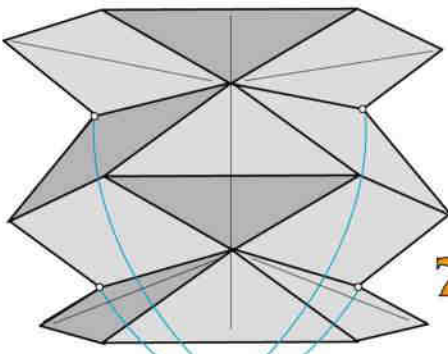

Comprimete

7

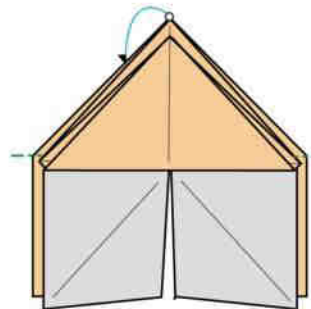

1 piega a monte posteriore

8

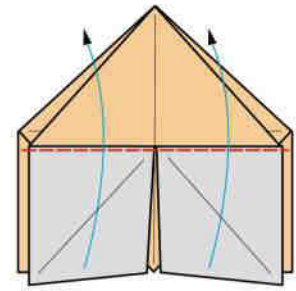

2 pieghe a valle

9

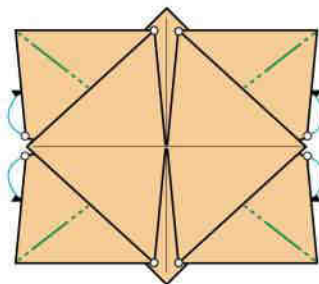

4 pieghe a monte

10

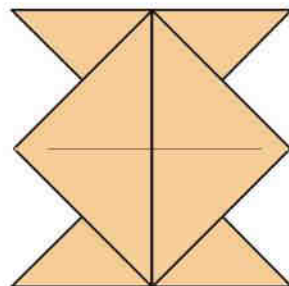

Ribaltate

11

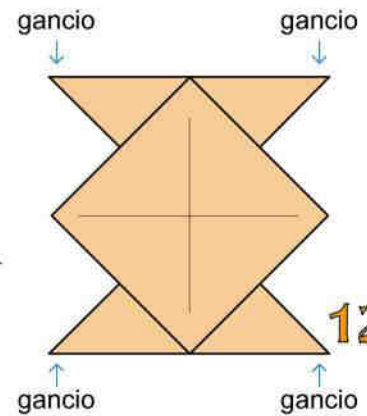

12

MODULO PER NASTRI CUORE CON 2 GANCI E 2 TASCHE

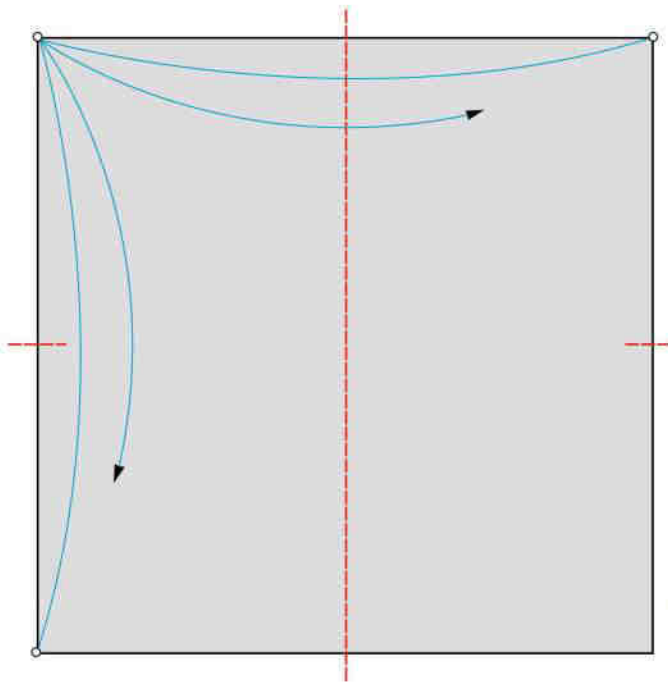

1

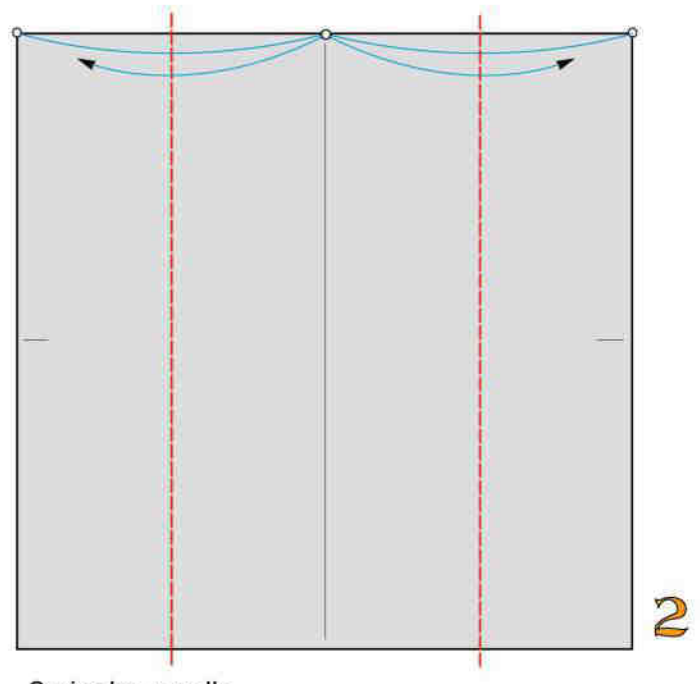

2

3 pieghe a valle, di cui 2 piccole

2 pieghe a valle

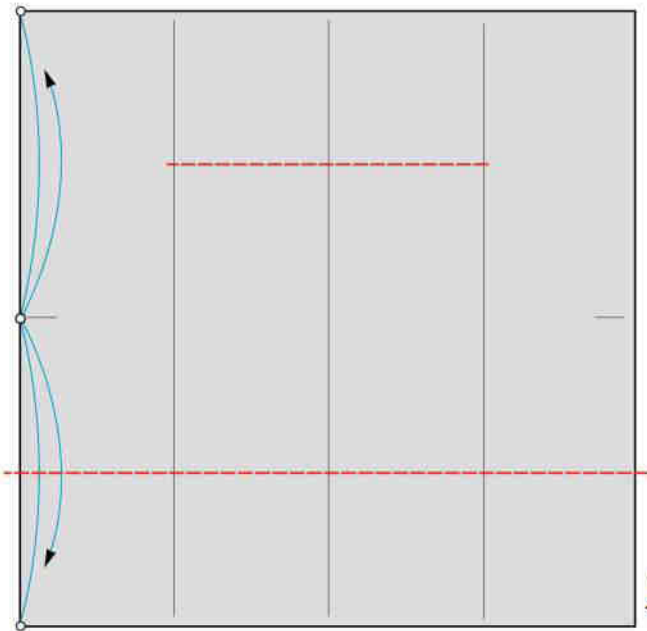

3

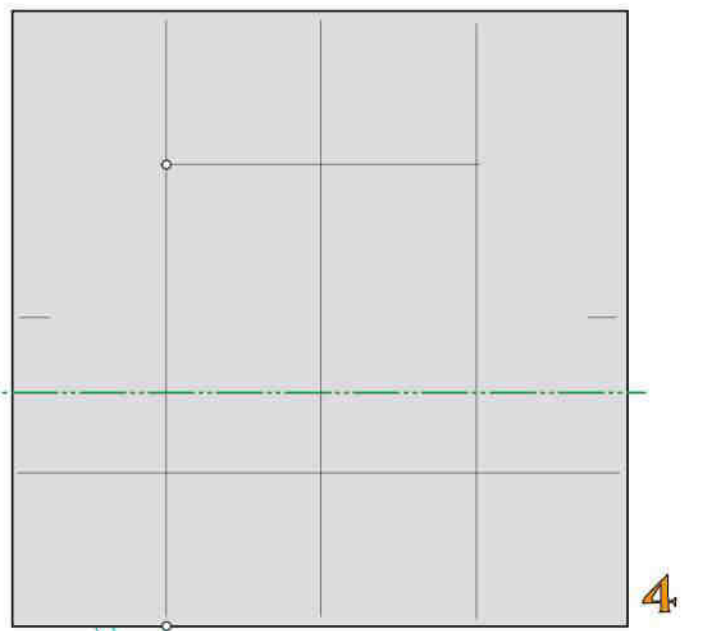

4

2 pieghe a valle

1 piega a monte

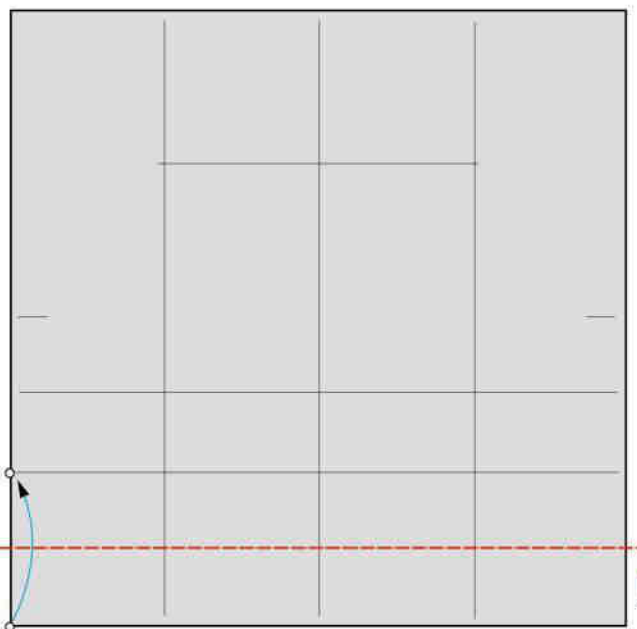

5

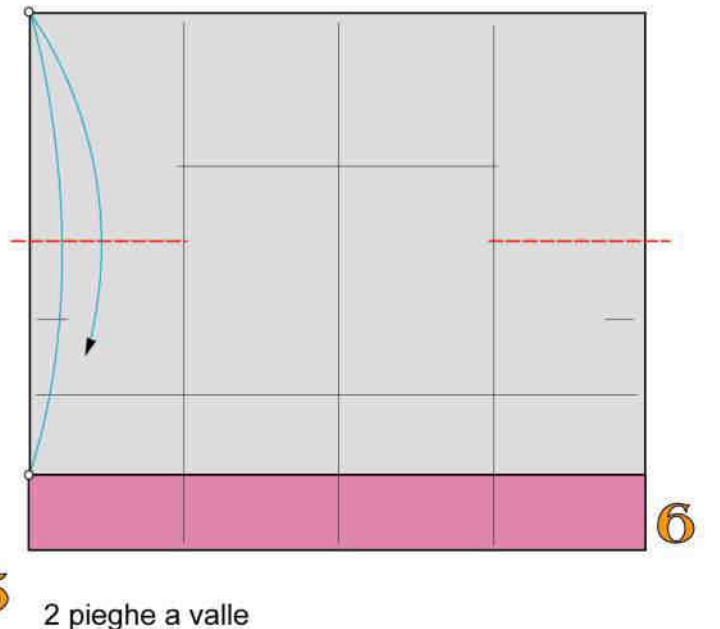

6

2 pieghe a valle

1 piega a valle

31

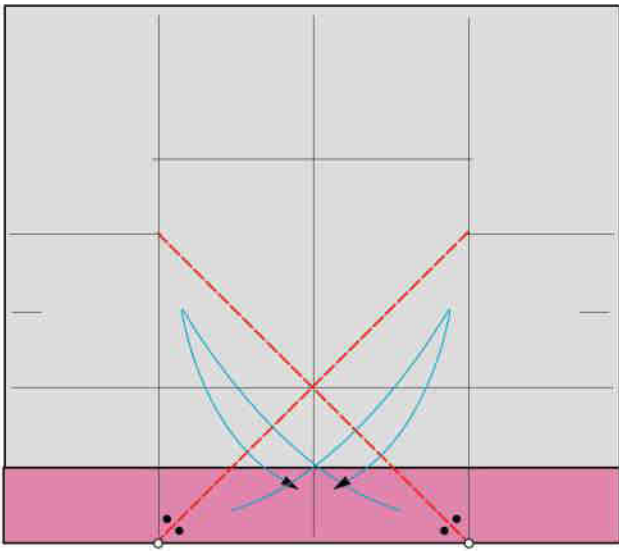

7

2 pieghe bisettrici a valle

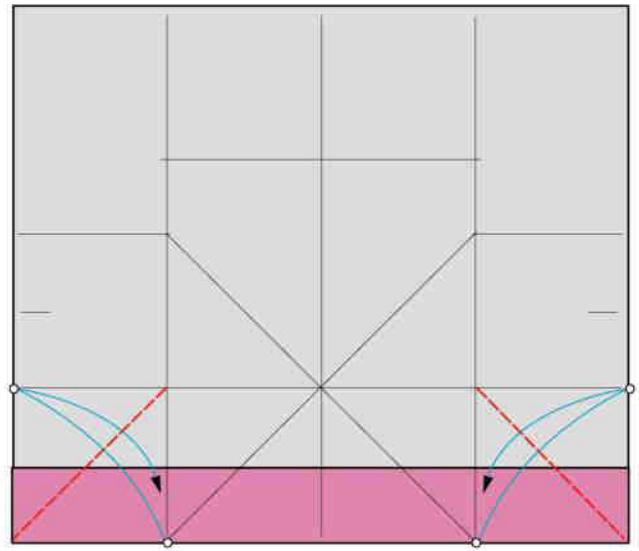

8

2 pieghe diagonali a valle

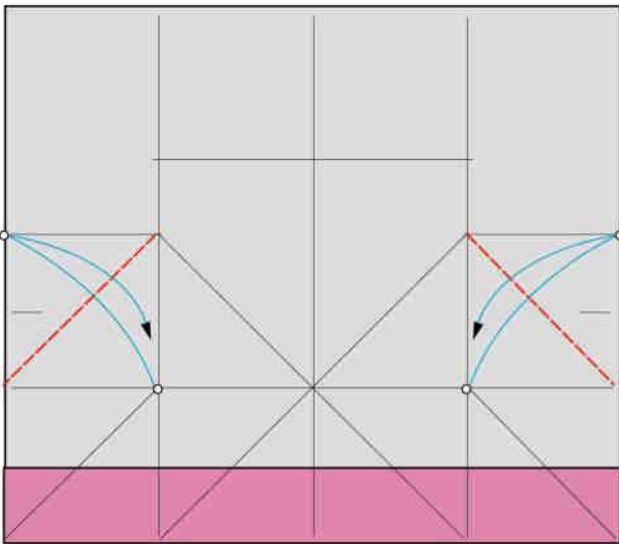

9

2 pieghe diagonali a valle

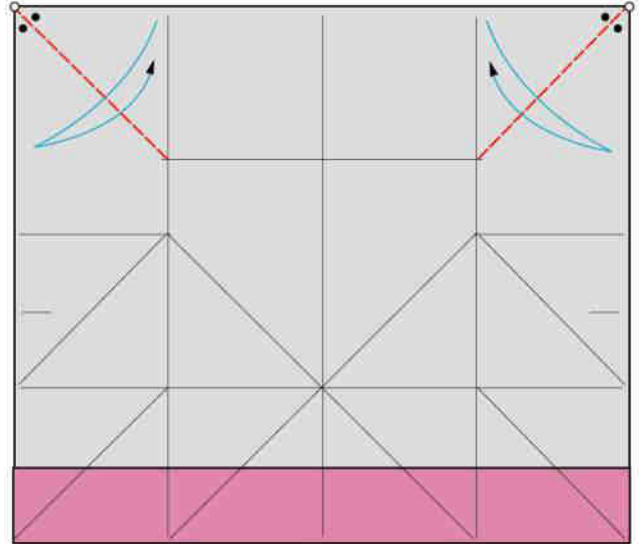

10

2 pieghe bisettrici a valle

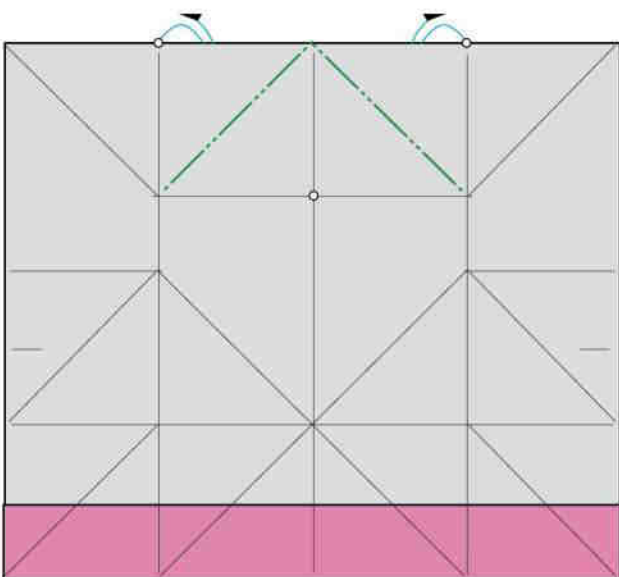

11

2 pieghe diagonali a monte

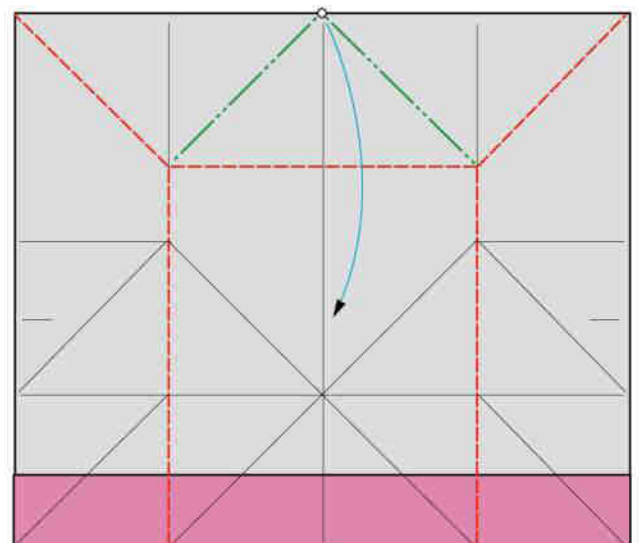

12

Ripiegate a valle e a monte

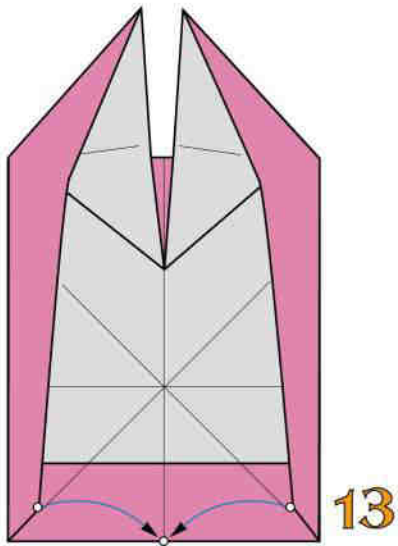

Richiudete

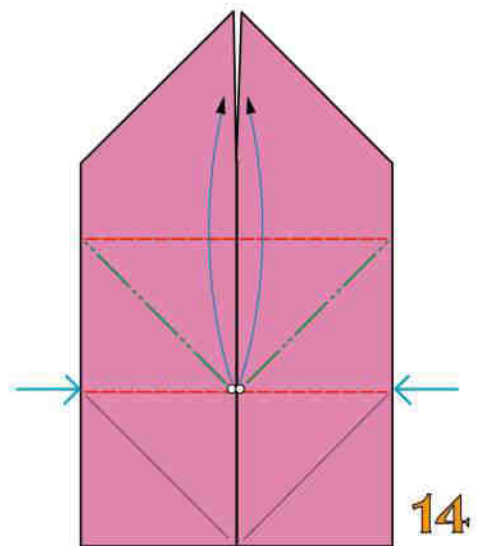

Ripiegate a valle e a monte

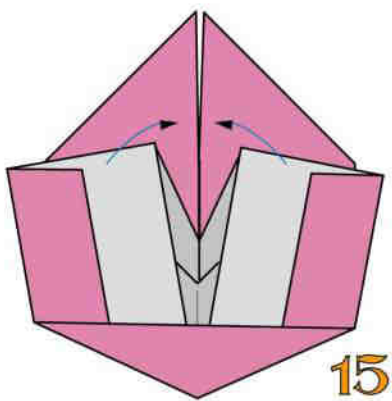

Comprimete

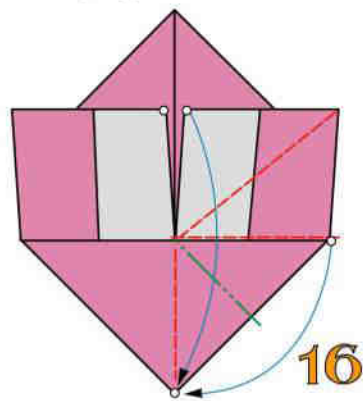

Ripiegate a valle e a monte

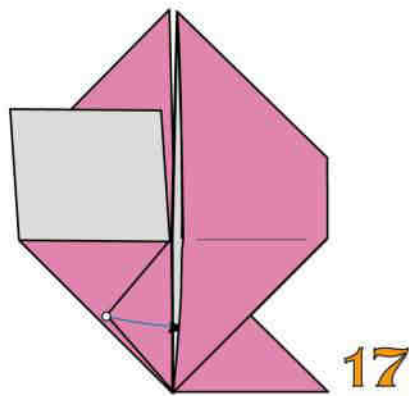

Intascate il vertice

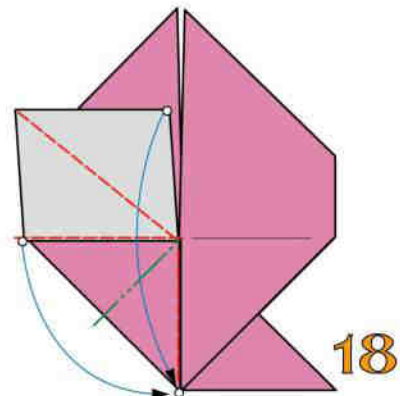

Ripiegate a valle e a monte

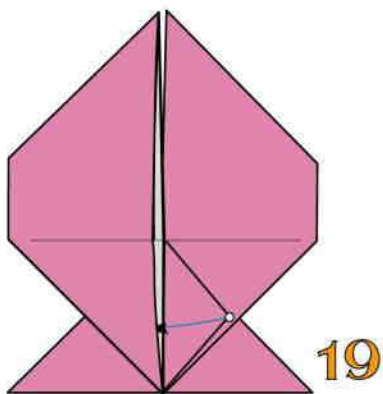

Intascate il vertice

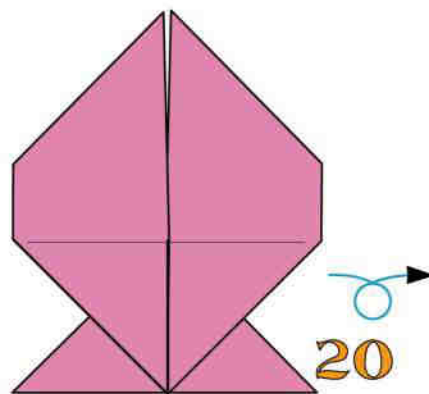

Ribaltate

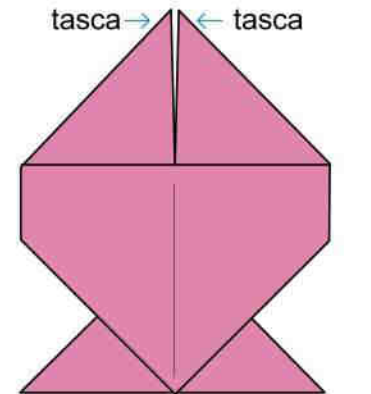

gancio

gancio

UNIONE DI MODULI CUORE

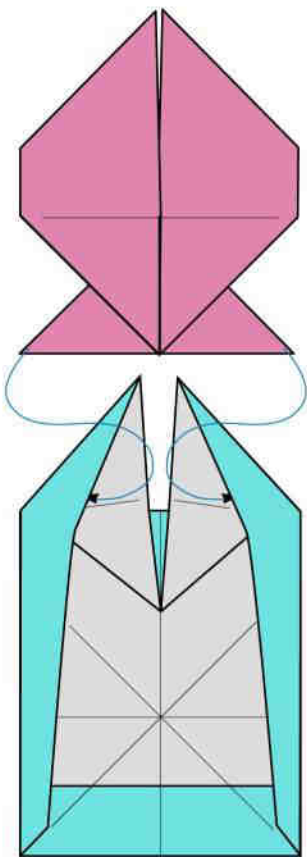

1

Inserite 2 ganci entro 2 tasche

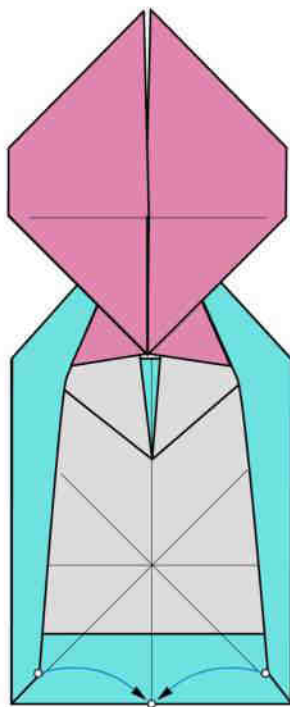

2

Richiudete il modulo ricevente

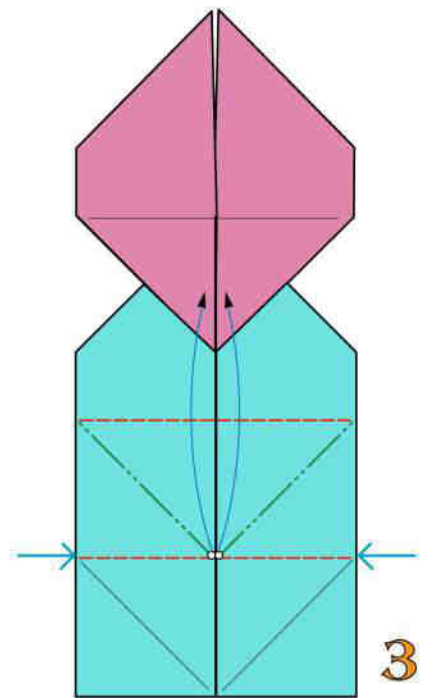

3

Ripiegate a valle e a monte come già visto

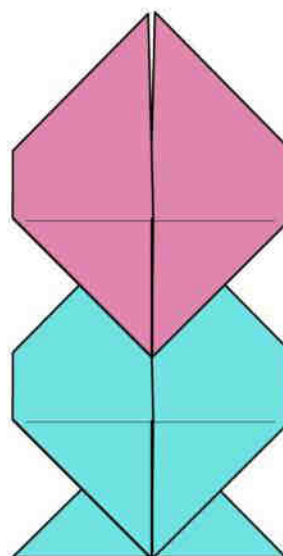

4

Moduli uniti.
Ribaltate

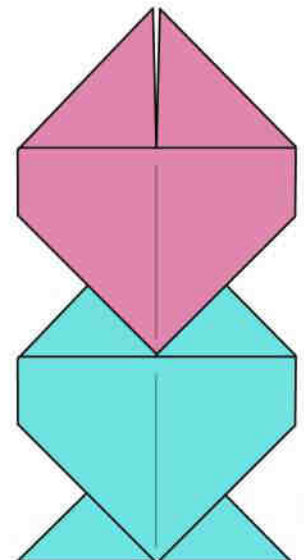

5

UNIONE DI MODULI CORNICE

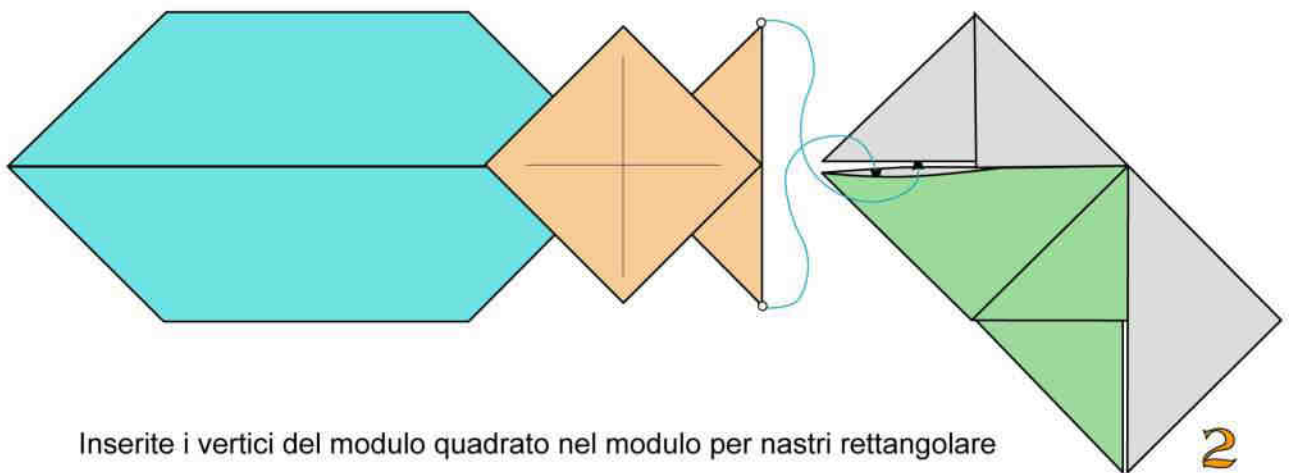
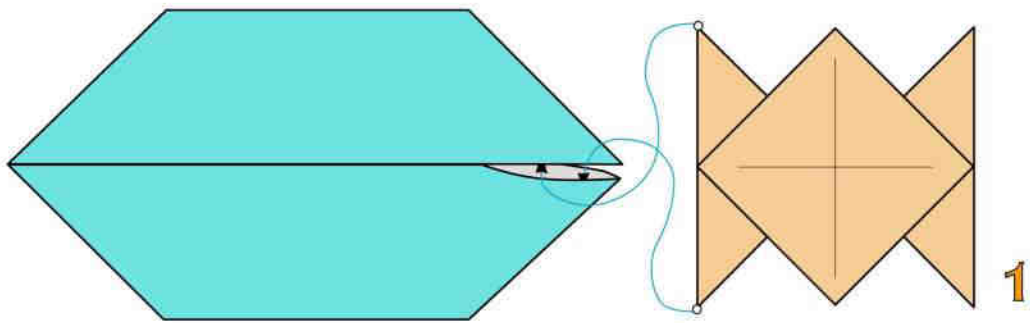

Inserite i vertici del modulo quadrato nel modulo per nastri rettangolare

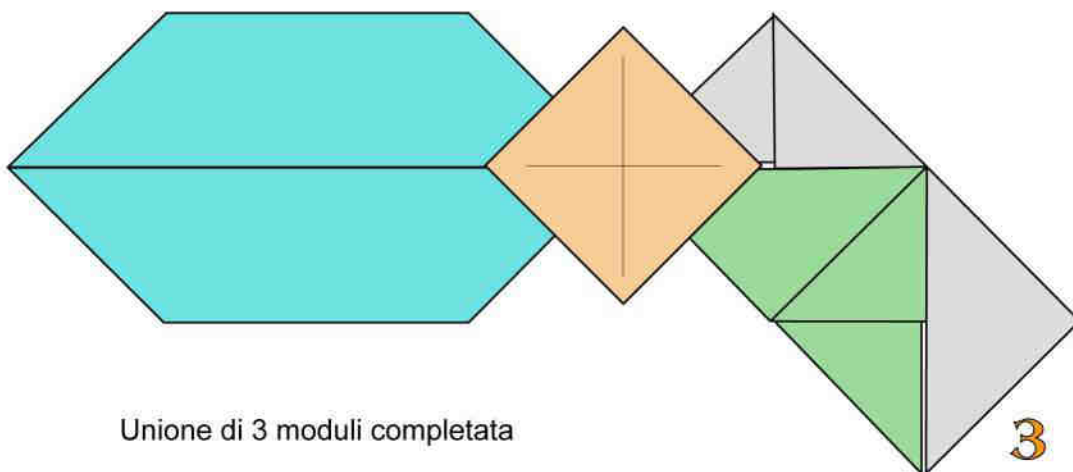

Unione di 3 moduli completata

NASTRO "3D"

Franco Pavarin 24

È formato da prismi retti con base triangolo isoscele (mezzi cubi).
Adoperate fogli monocolori di carta di medio peso delle dimensioni di cm 10x10

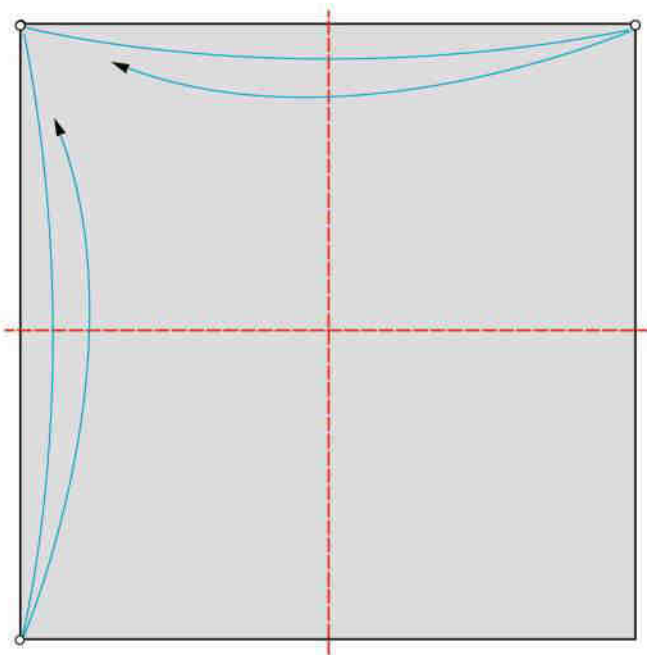

1

2 pieghe a valle

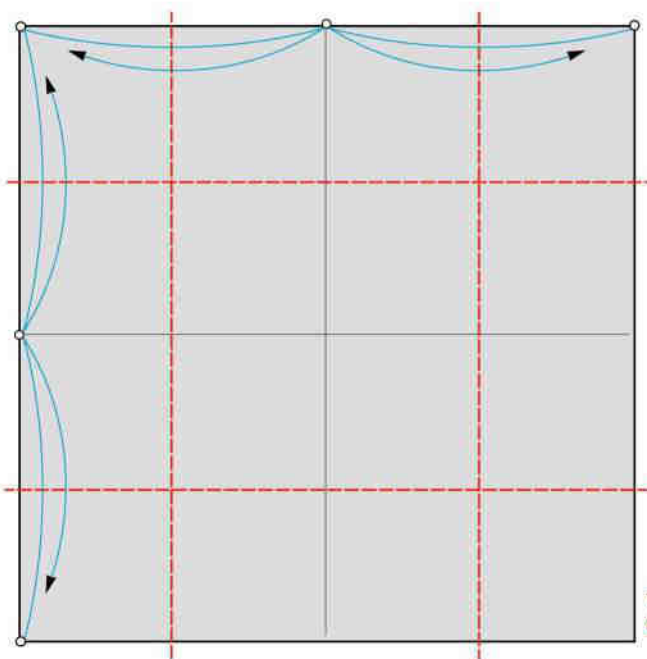

4 pieghe a valle

2

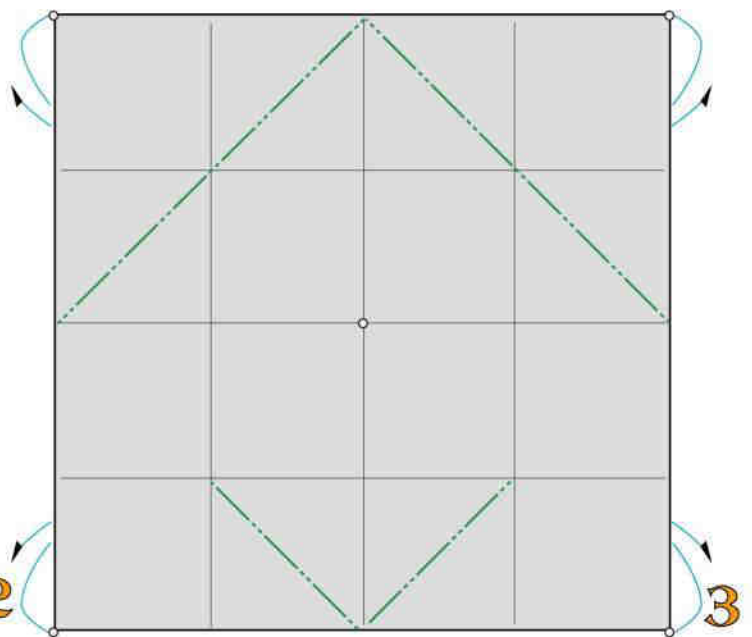

4 pieghe a monte

3

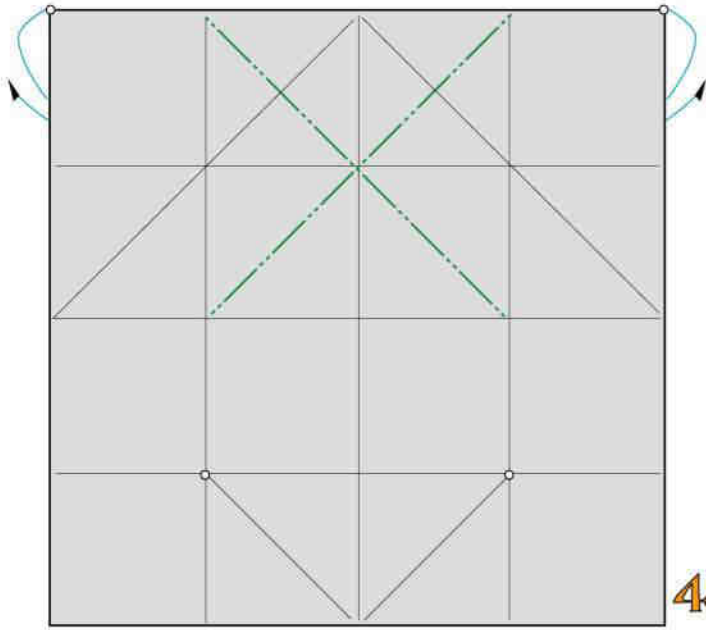

2 pieghe a monte

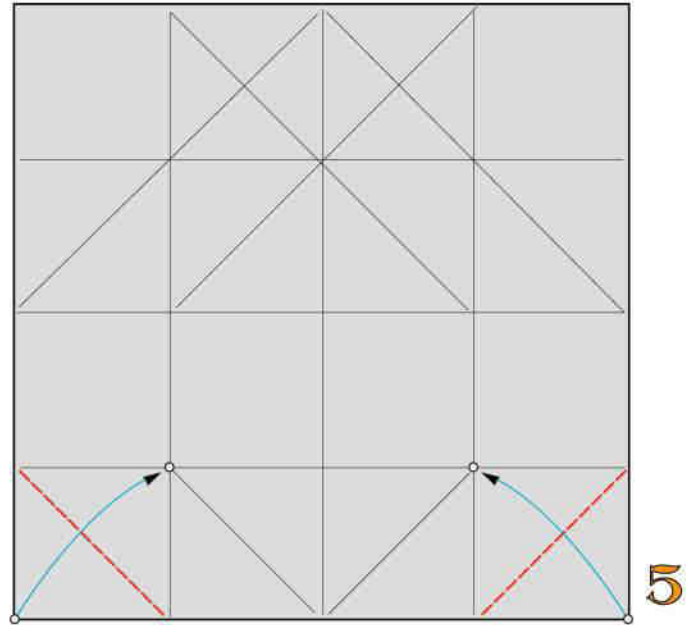

2 pieghe a valle

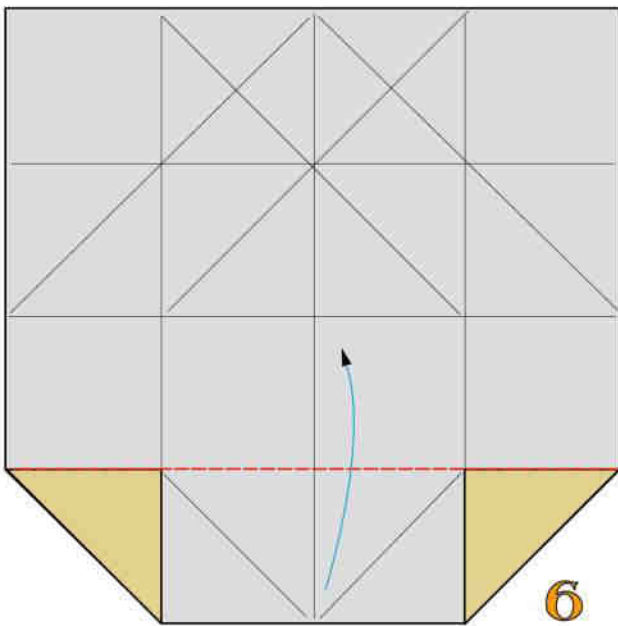

Ripiegate a valle

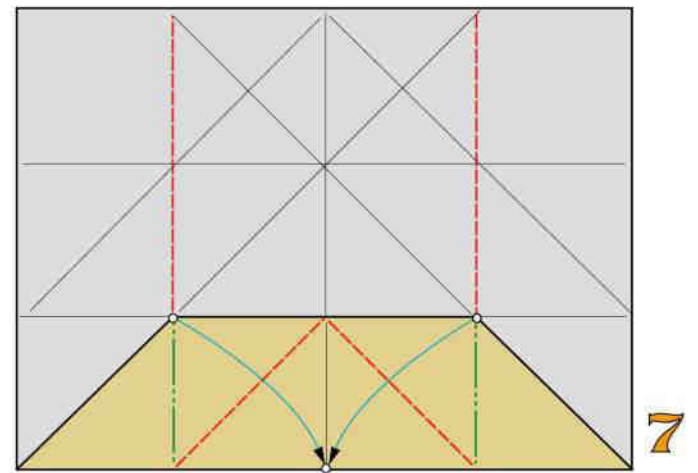

Ripiegate a valle e a monte modellando 3D

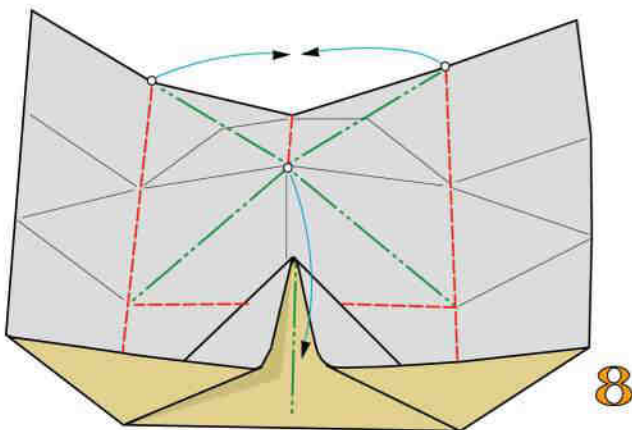

Ripiegate a valle e a monte modellando 3D

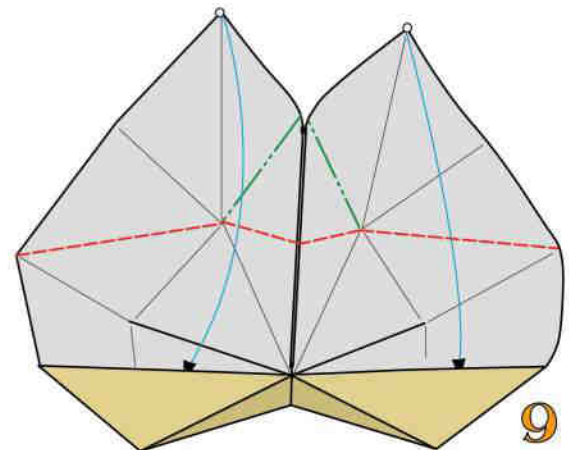

Ripiegate a valle e a monte modellando 3D

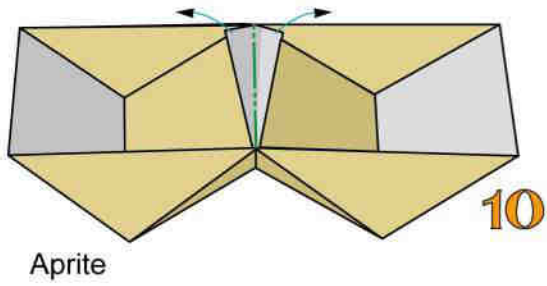

Aprite

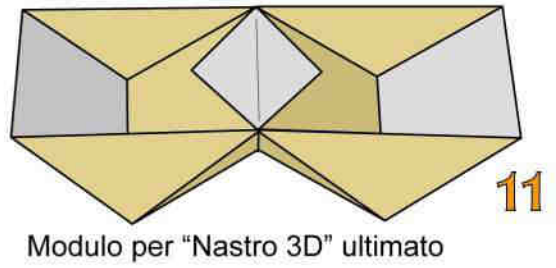

Modulo per "Nastro 3D" ultimato

UNIONE DEI MODULI

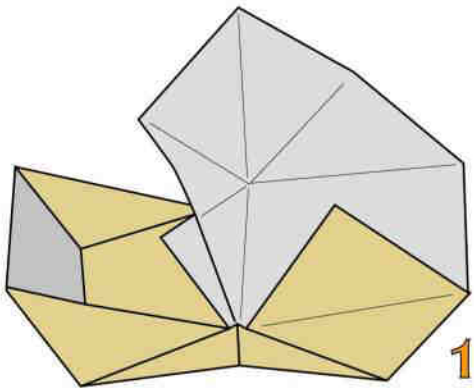

Aprite metà di un modulo

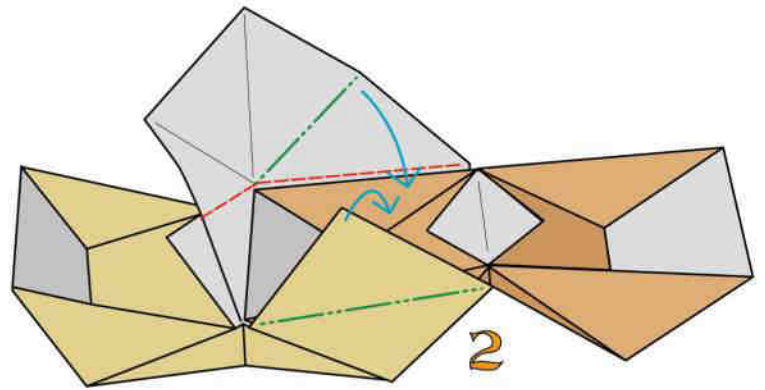

Inserite un secondo modulo e richiudete i bordi del primo

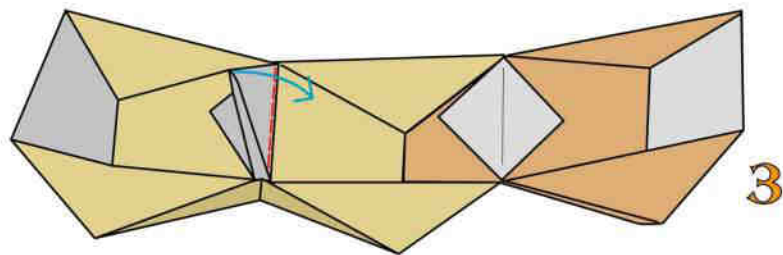

Aprite

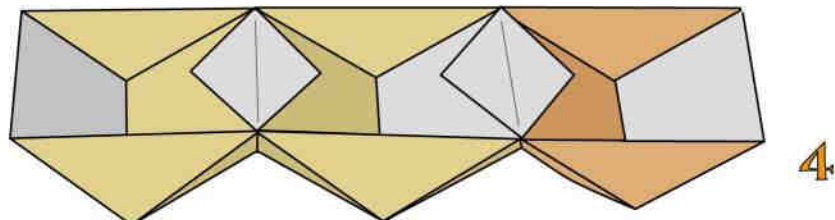

Unione di 2 moduli di "Nastro 3D" ultimata

CATENA

Franco Pavarin 23

Adoperate carta leggera di almeno cm 10x10.
Fate assumere consistenza
tridimensionale agli anelli
solo a catena ultimata

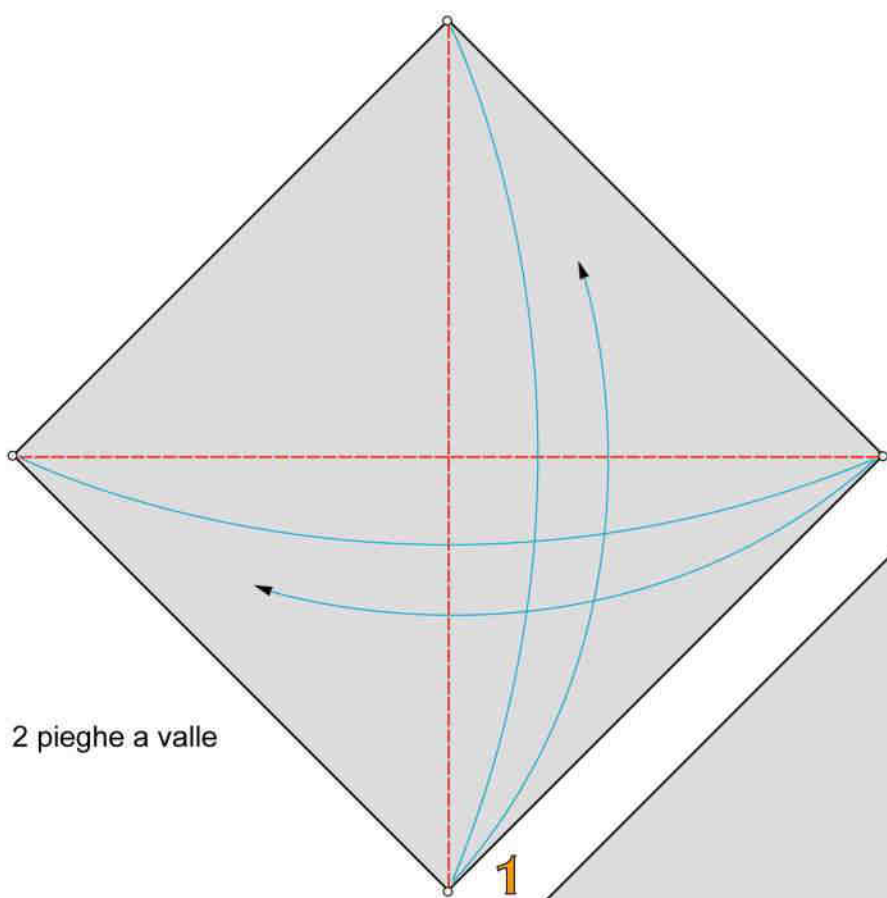

2 pieghe a valle

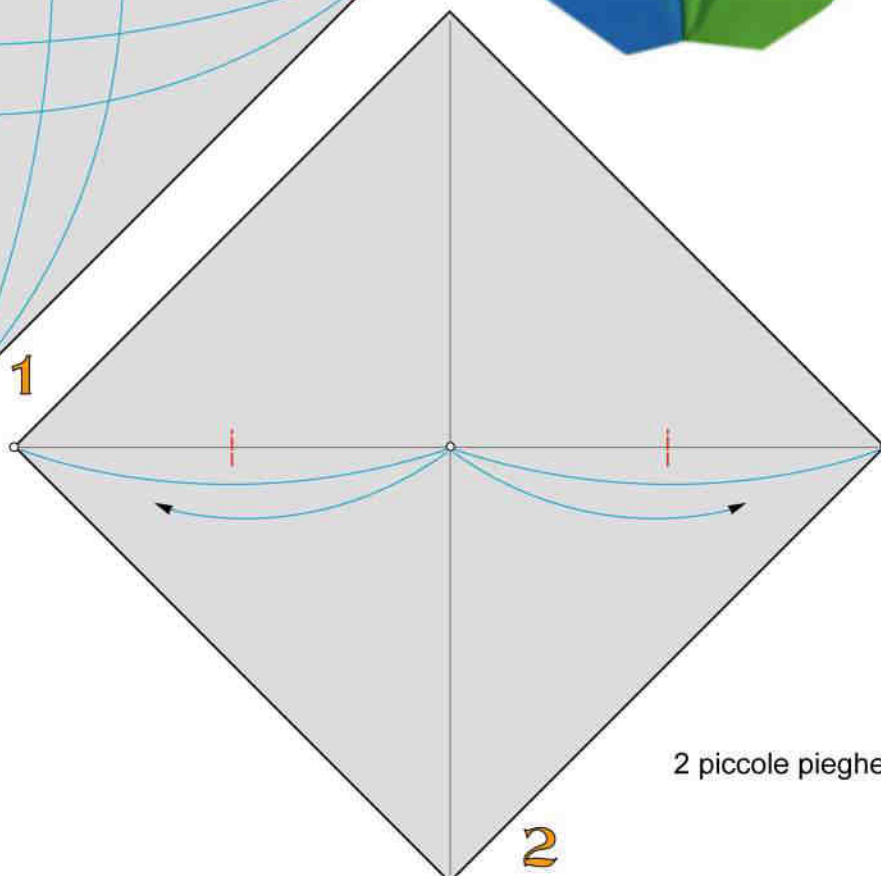

2 piccole pieghe a valle

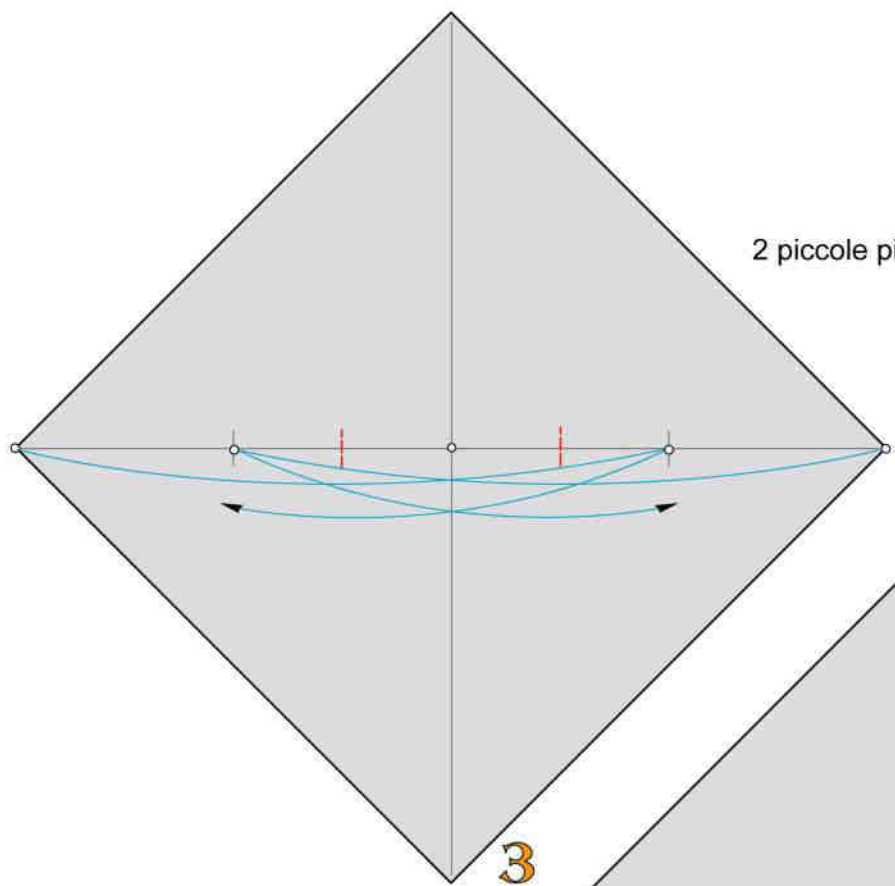

2 piccole pieghe a valle

3

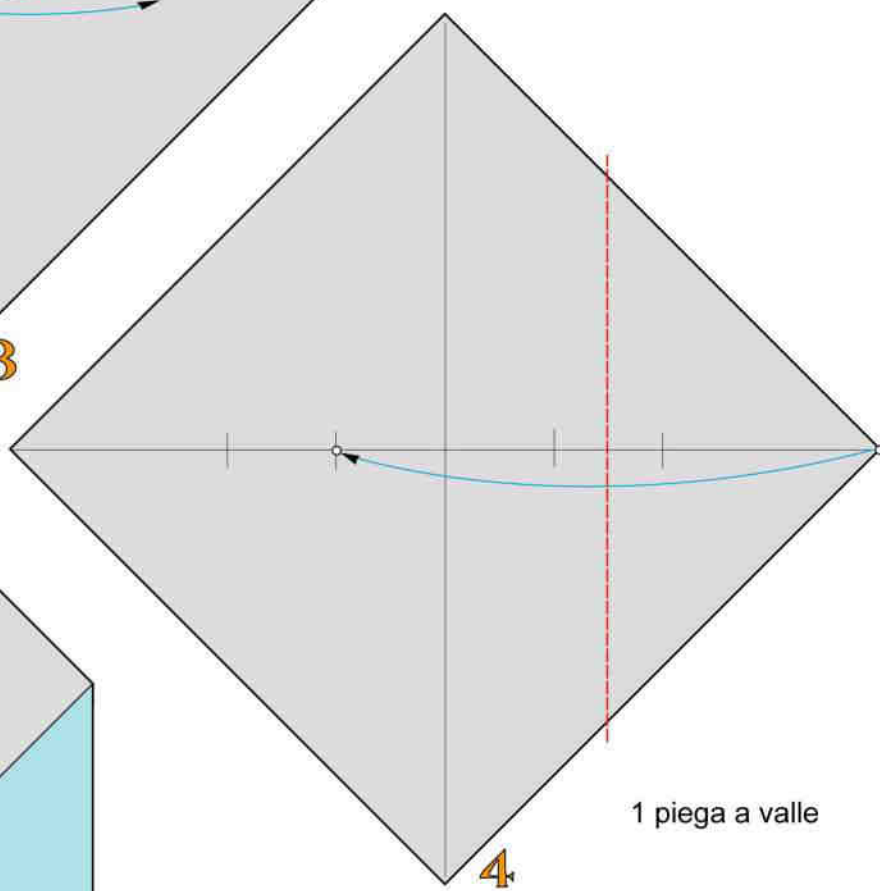

1 piega a valle

4

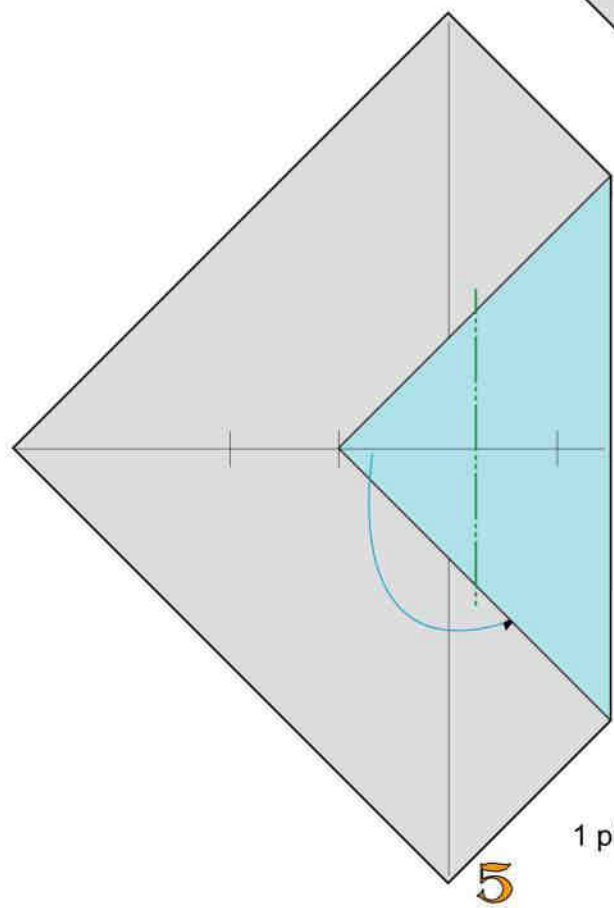

1 piega a monte

5

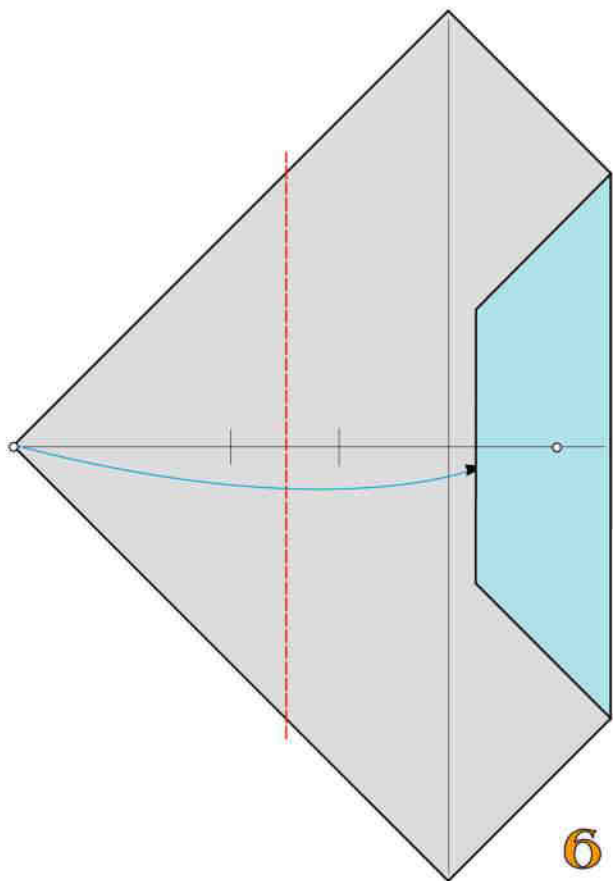

6

1 piega a valle

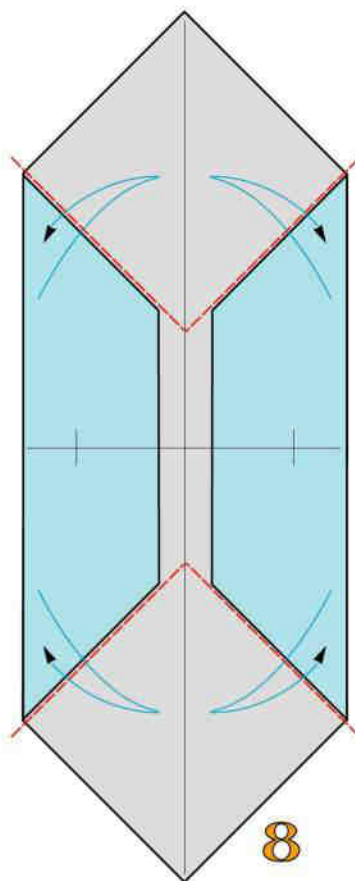

8

4 pieghe a valle

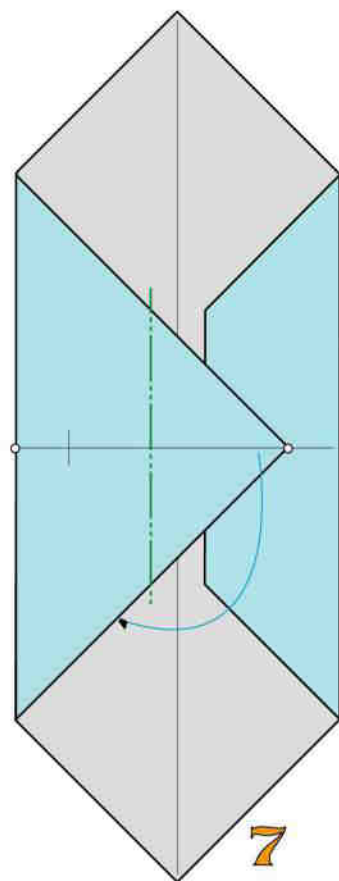

7

1 piega a monte

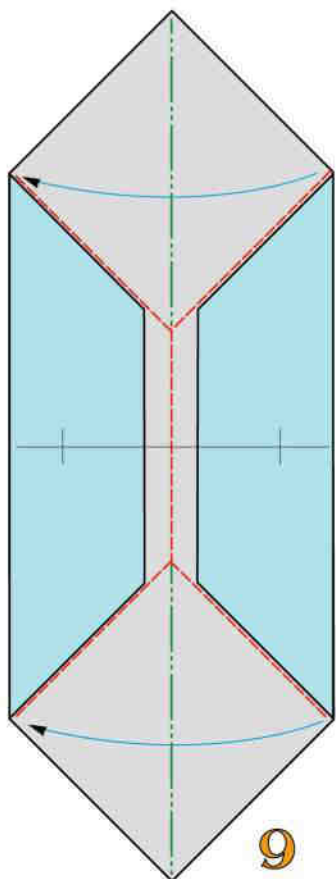

9

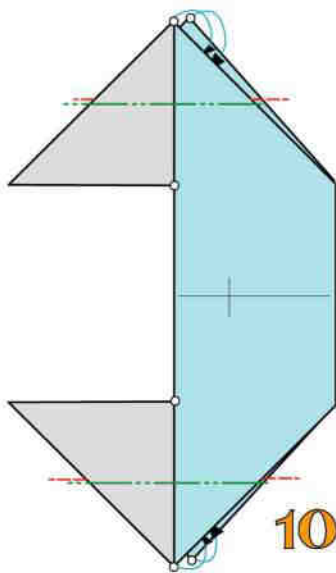

10

2 pieghe a monte per lato

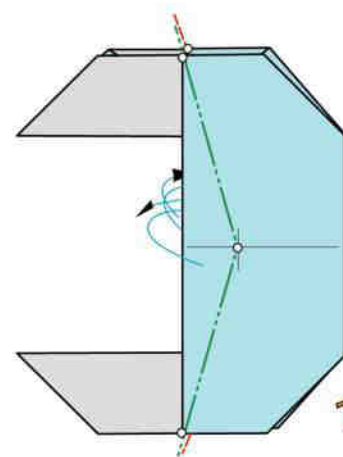

11

2 pieghe a monte per lato

UNIONE DEI MODULI

Ripiegate a valle e a monte

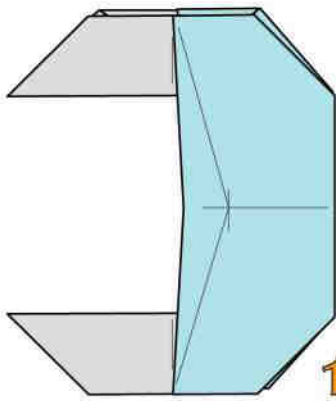

Modulo "Catena" ultimato

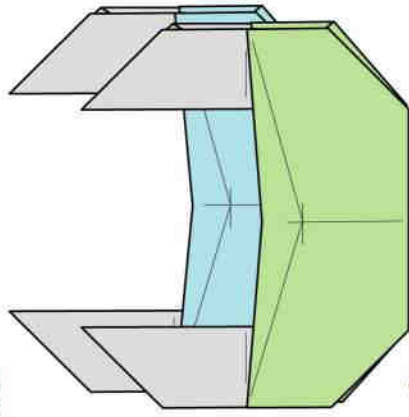

Sovrapponete 2 moduli

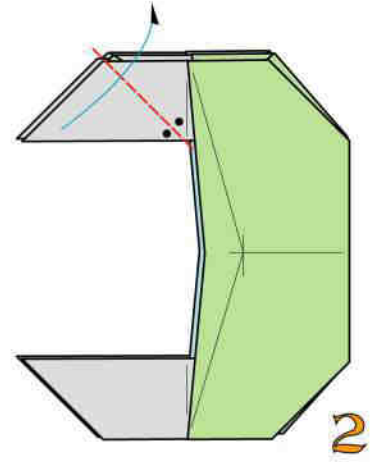

1 piega bisettrice a valle

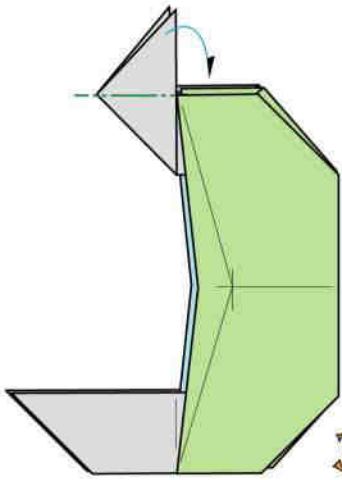

1 piega a monte

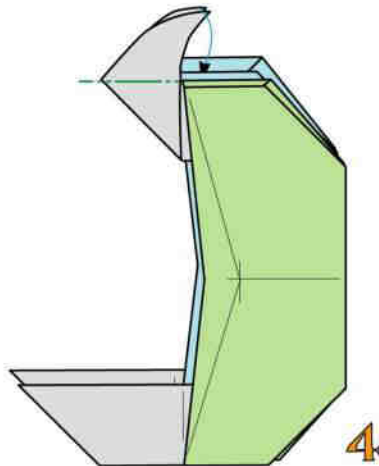

Intascate nella quarta tasca

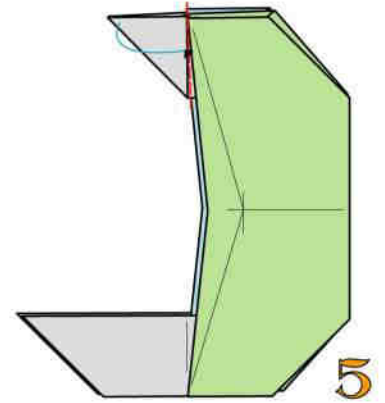

Intascate nella prima tasca

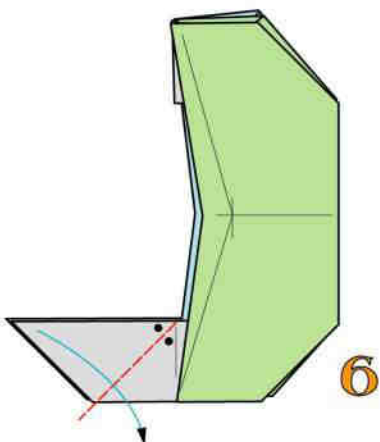

Ripetete le pieghe delle figure 2,3,4,5

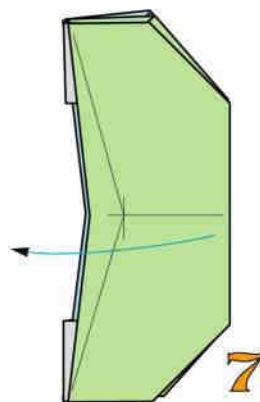

Ruotate

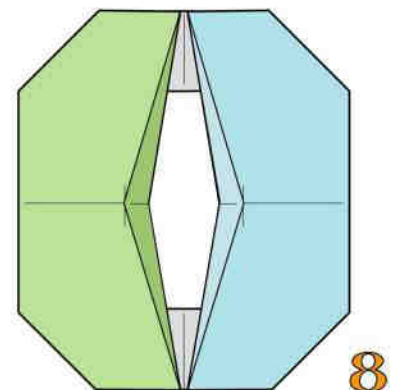

Anello ultimato

CATENA "3D"

Franco Pavarin 24

Ogni anello si ottiene unendo 2 moduli uguali da costruire con fogli monocolori di carta di medio peso delle dimensioni di cm 10x10

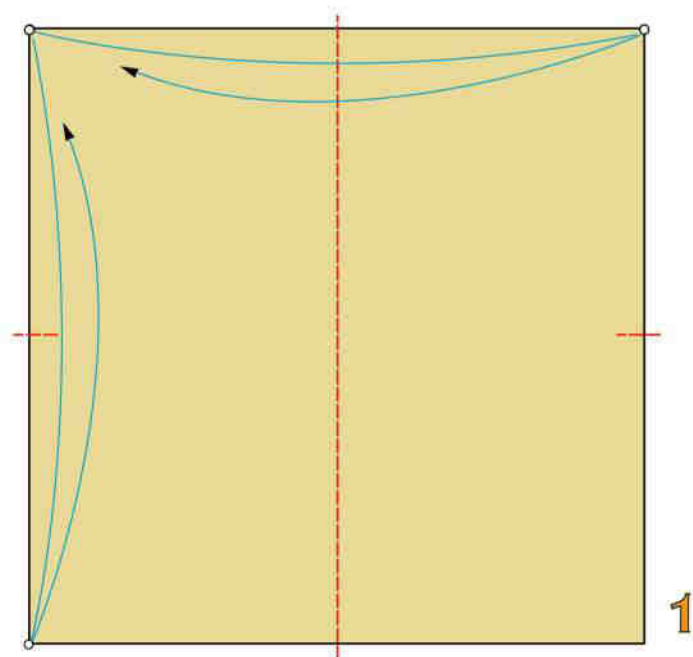

3 pieghe a valle, di cui 2 piccole



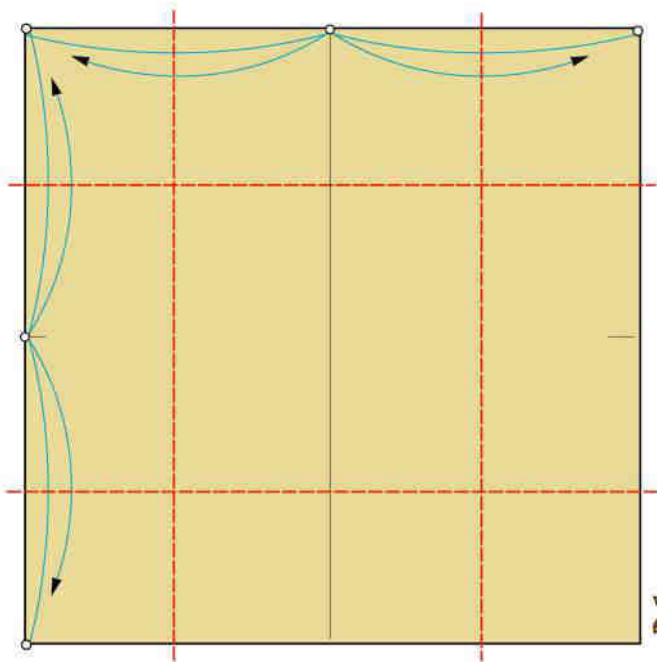

4 pieghe a valle

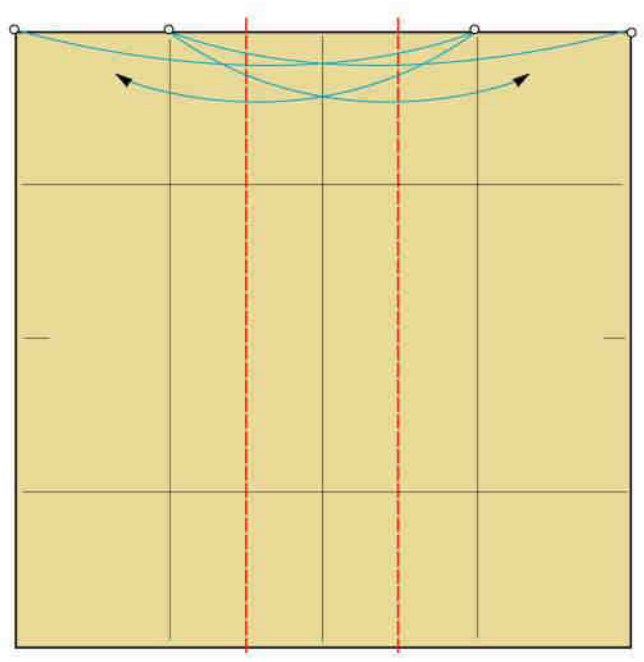

2 pieghe a valle

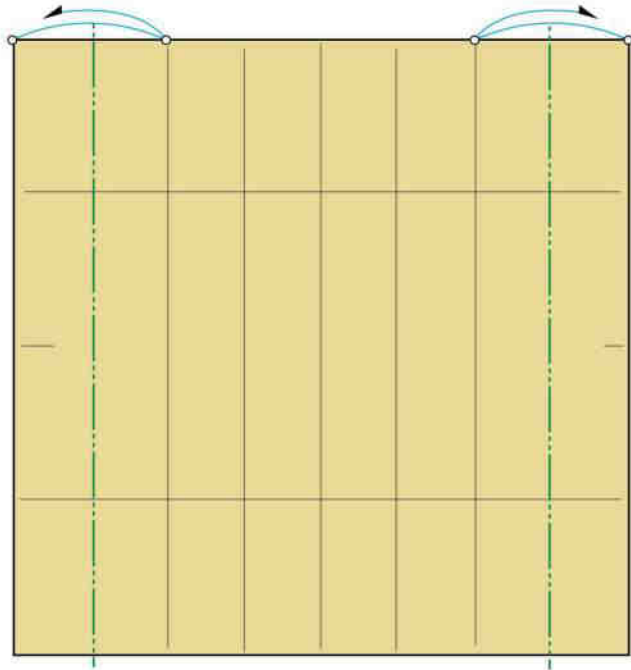

2 pieghe a monte

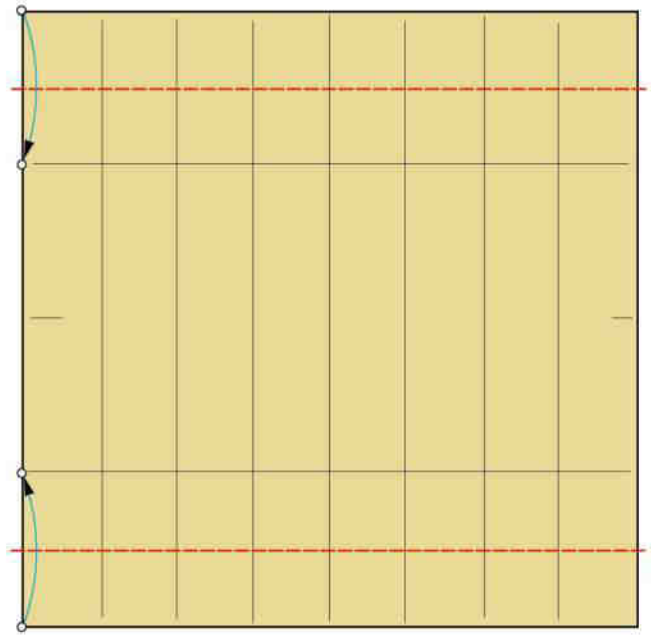

2 pieghe a valle

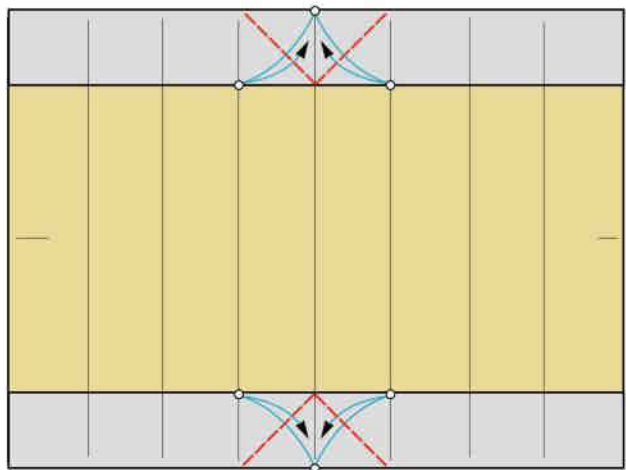

4 pieghe a valle

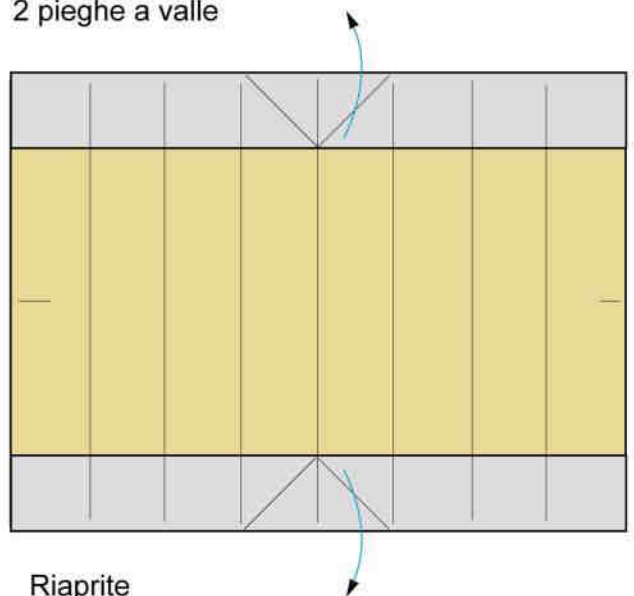

Riaprite

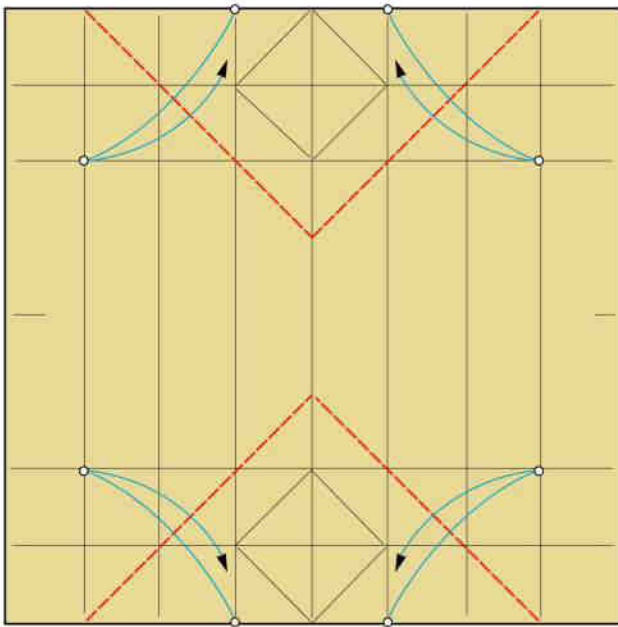

8

4 pieghe a valle

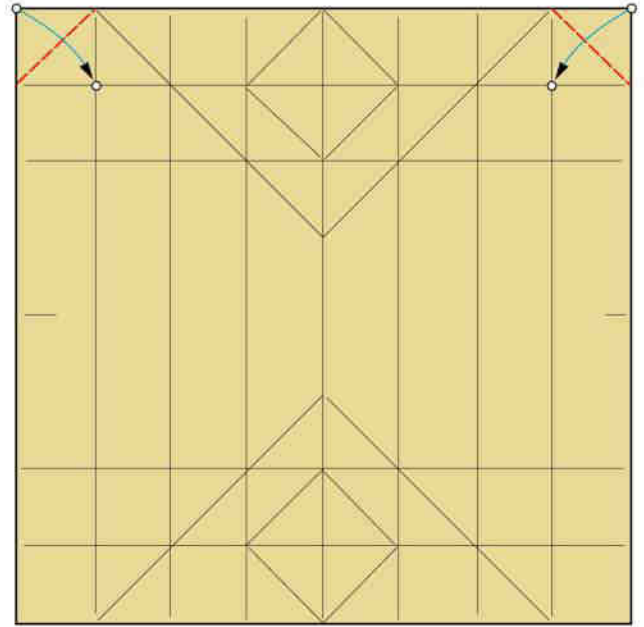

9

2 pieghe a valle

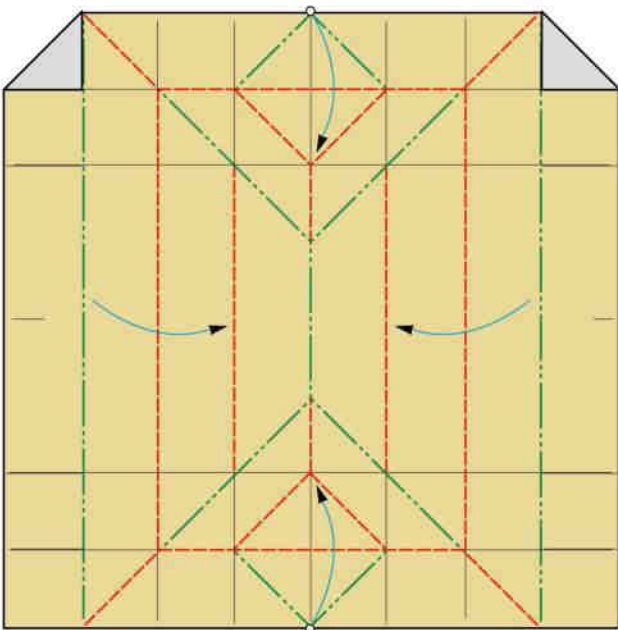

10

Ripiegate a valle e a monte

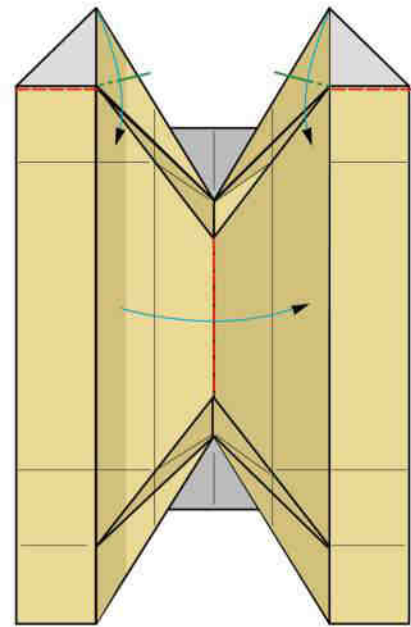

11

Abbassate i vertici chiudendo

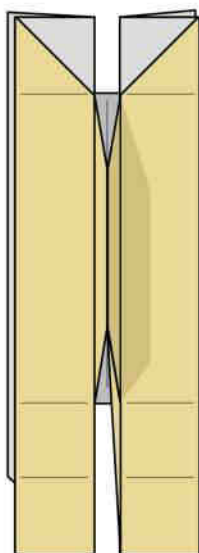

12

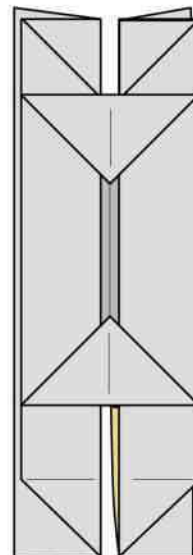

Modulo "Catena 3D" ultimato

UNIONE DEI MODULI

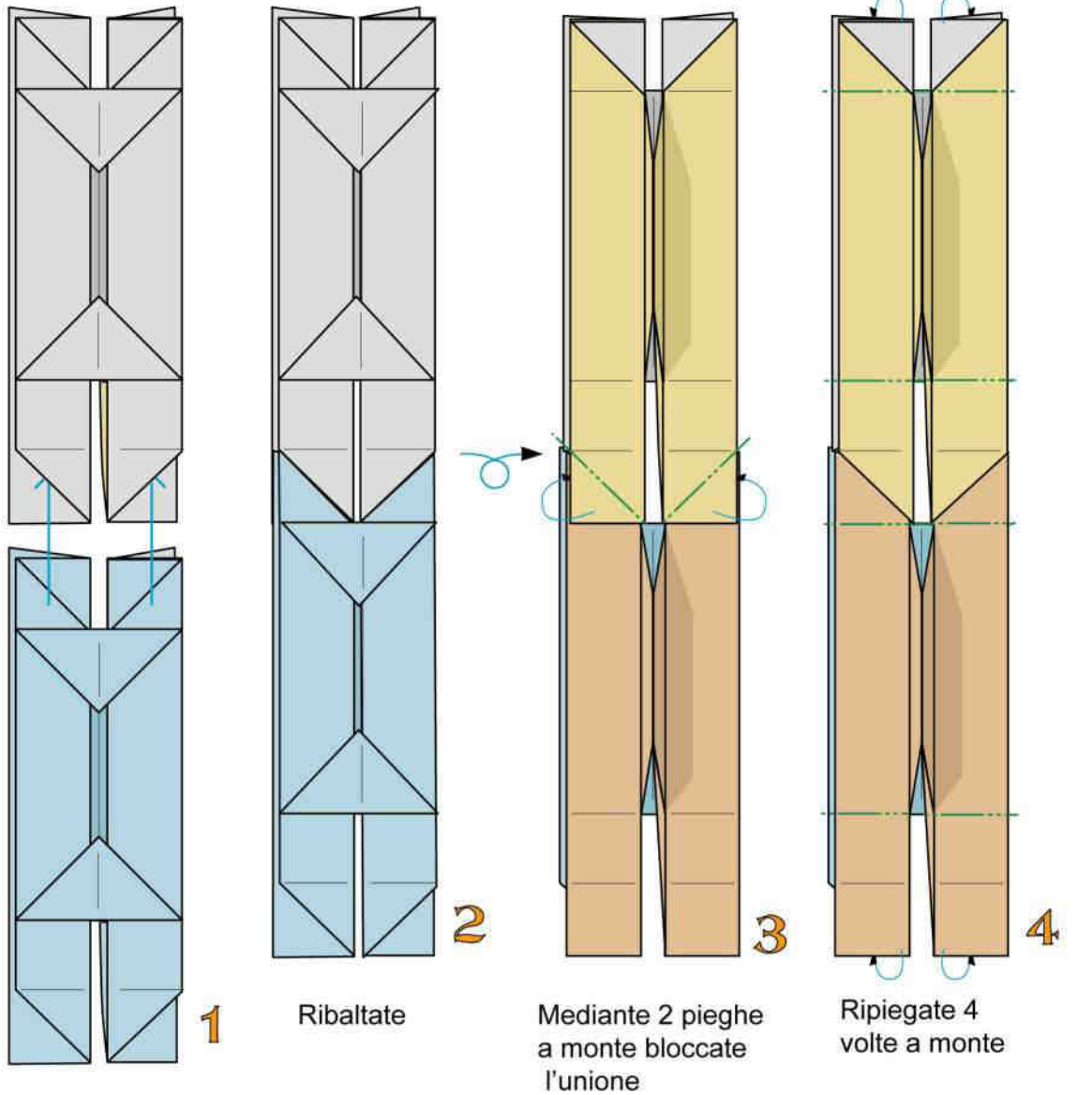

Intascate un modulo nell'altro

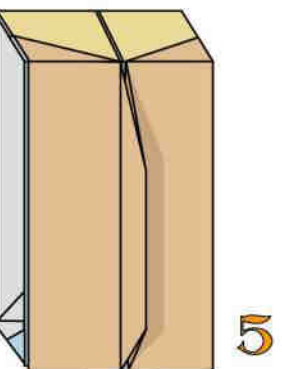

In basso ripetete le pieghe già viste chiudendo un anello della "Catena 3D"

BRACCIALE

Franco Pavarin 23

Di semplice costruzione, servono
8 fogli di carta di medio peso
e delle dimensioni di cm 10x10

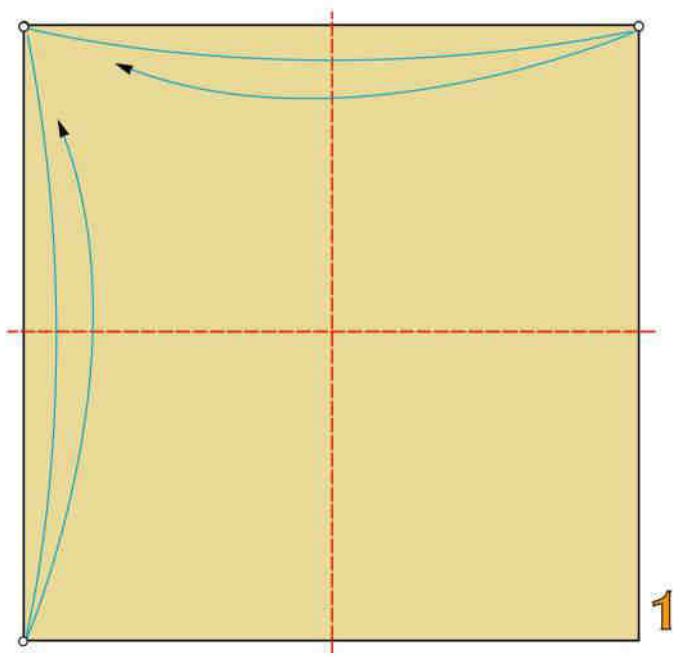
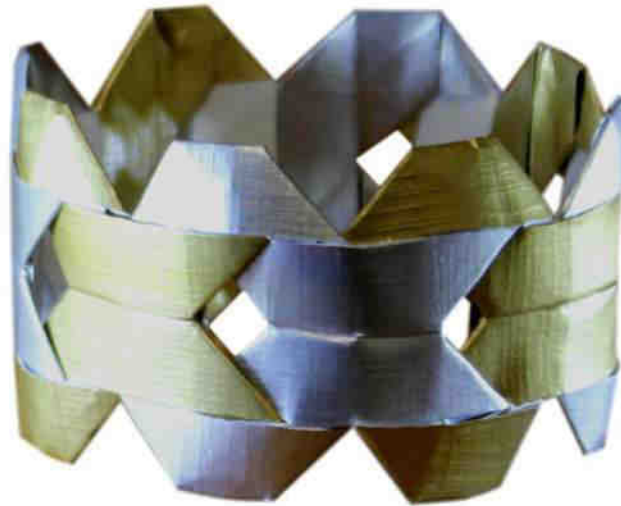

2 pieghe a valle

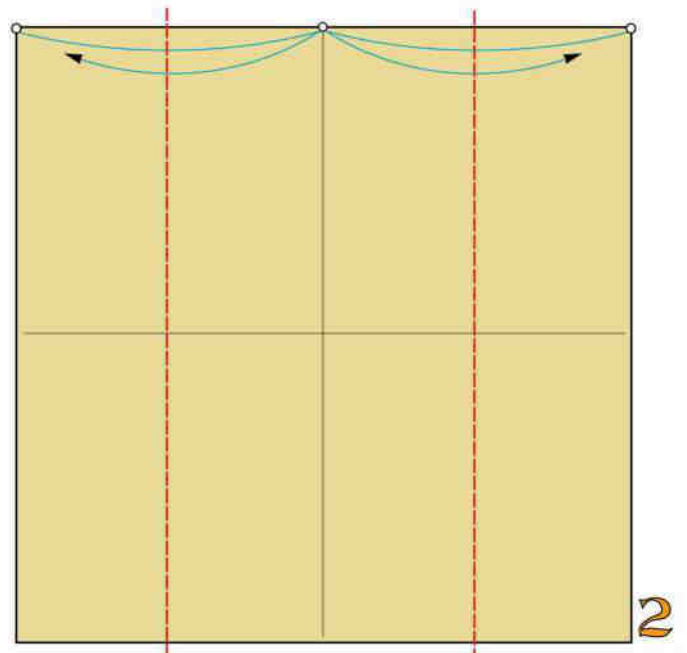

2 pieghe a valle

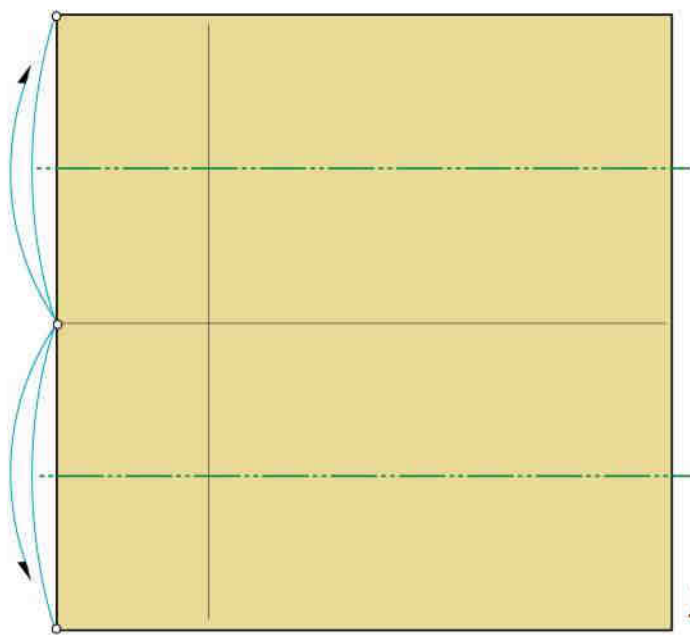

2 pieghe a monte

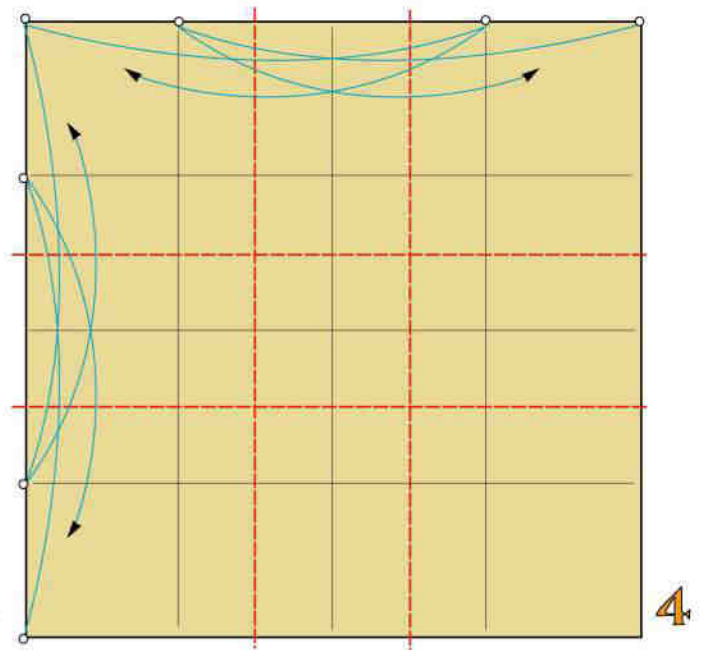

4 pieghe a valle

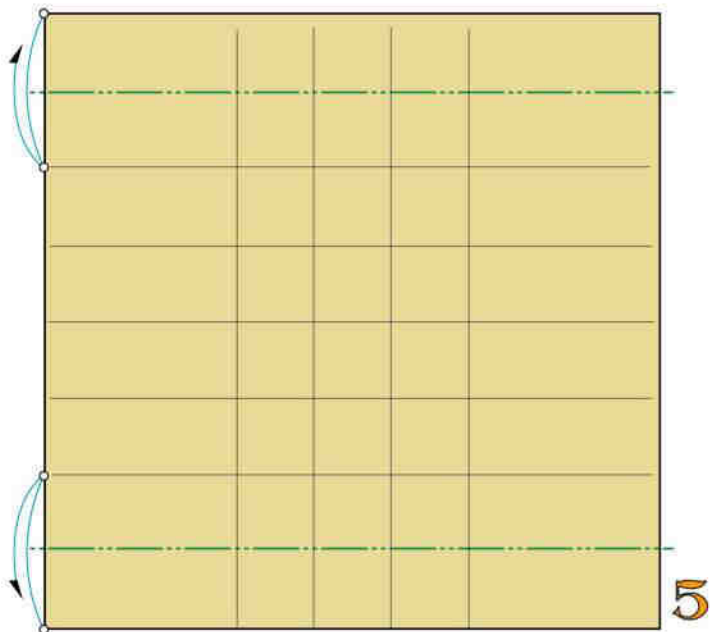

2 pieghe a monte

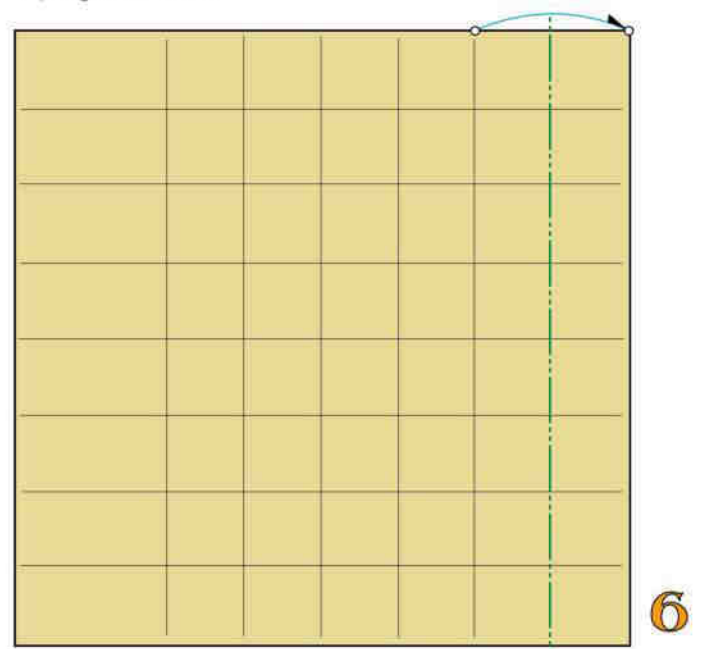

1 piega a monte

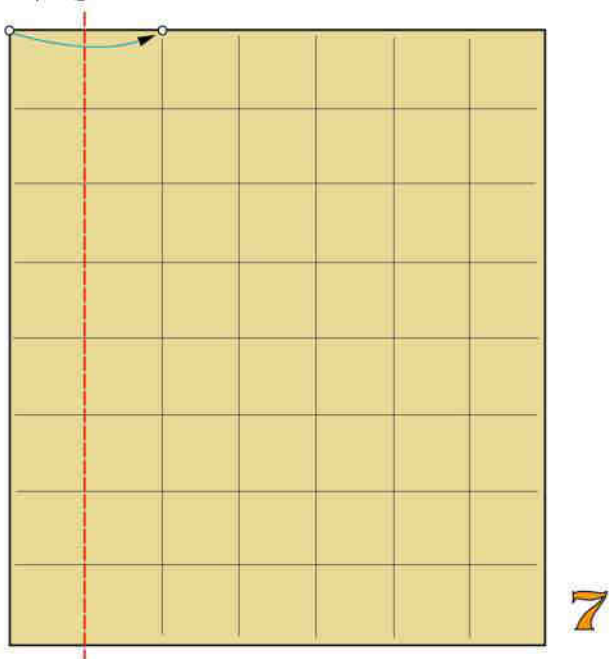

1 piega a valle

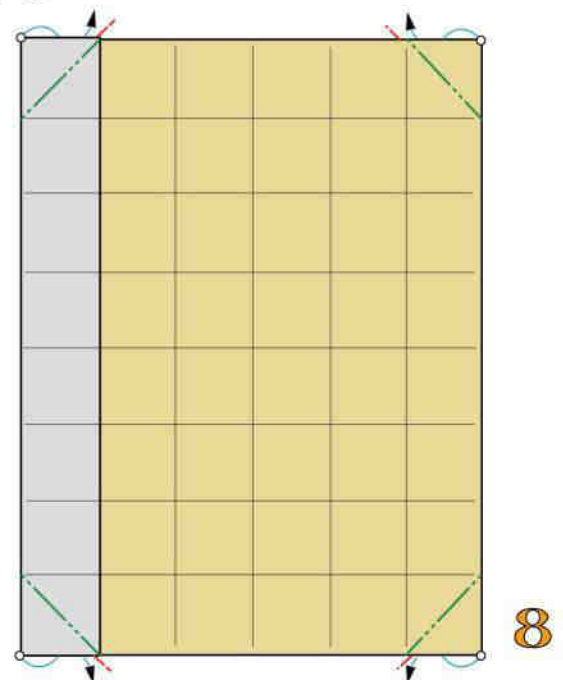

4 pieghe rovesce interne

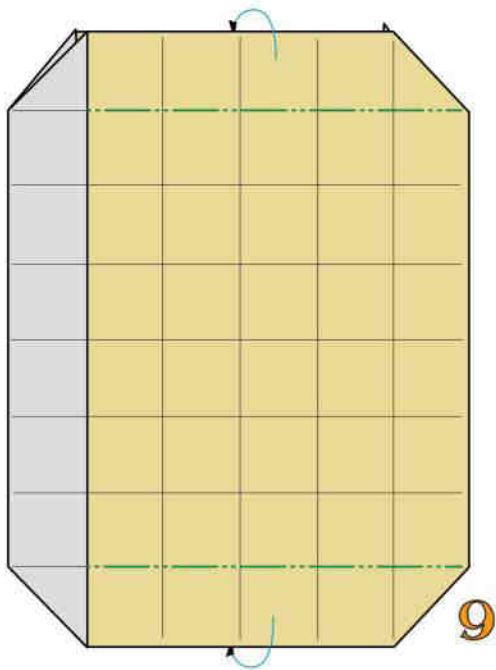

2 pieghe a monte

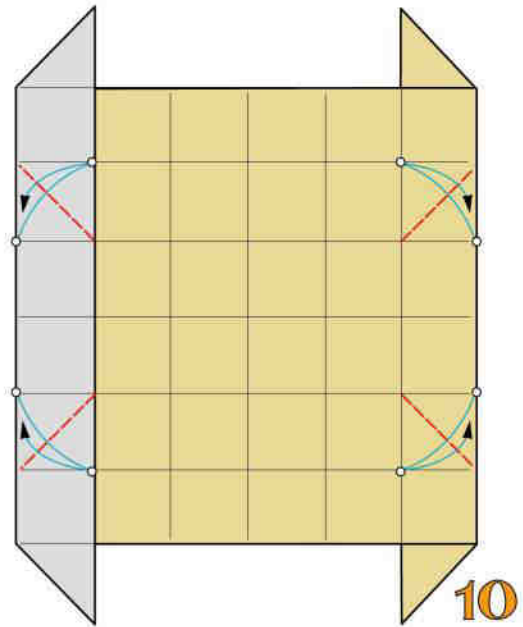

4 pieghe diagonali a valle

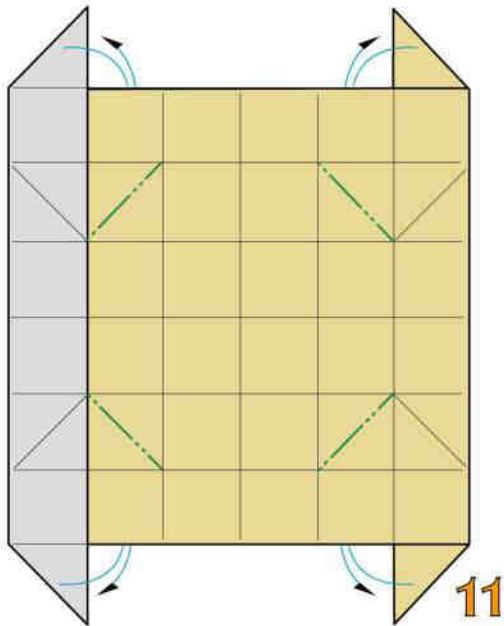

4 pieghe diagonali a monte

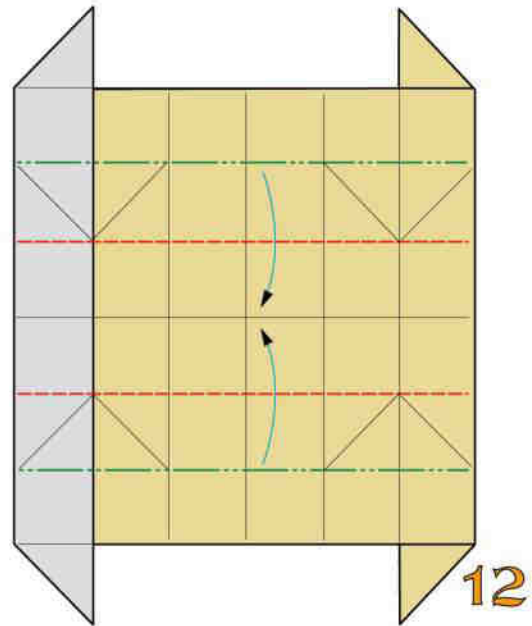

Ripiegate a valle e a monte

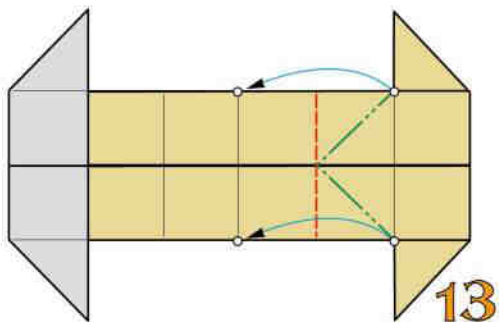

Ripiegate a valle e a monte

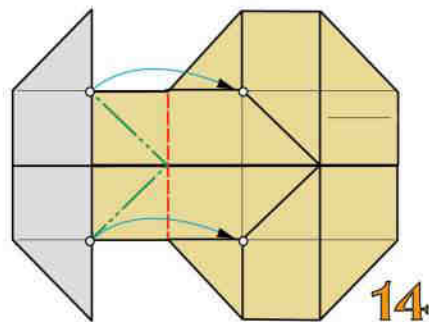

Ripiegate a valle e a monte

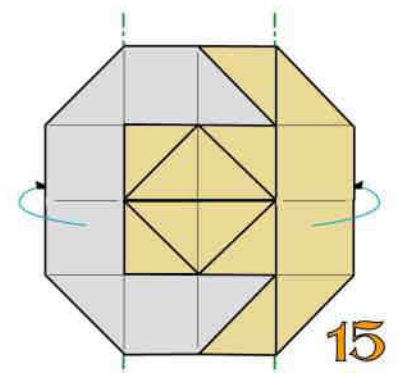

2 pieghe a monte retrostanti



4 pieghe a valle interne

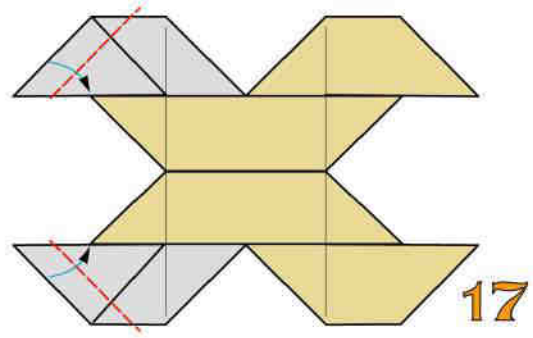

2 pieghe a valle

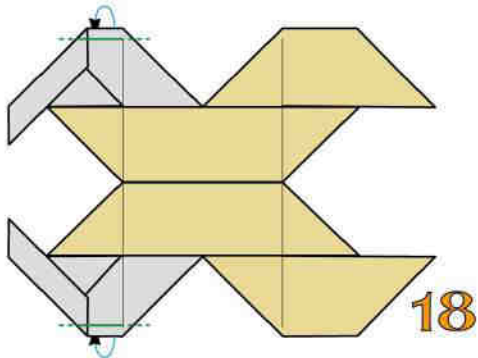

2 pieghe a monte

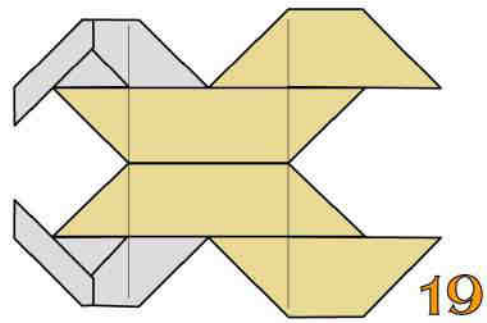

Modulo per bracciale ultimato

UNIONE DEI MODULI

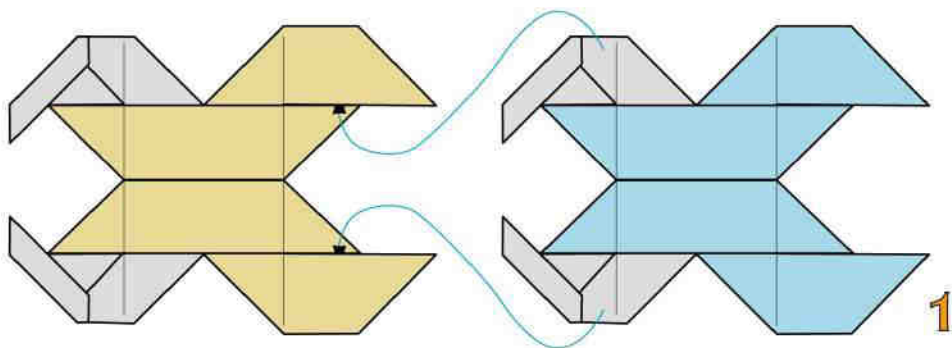

Intascate mezzo modulo nell'altro

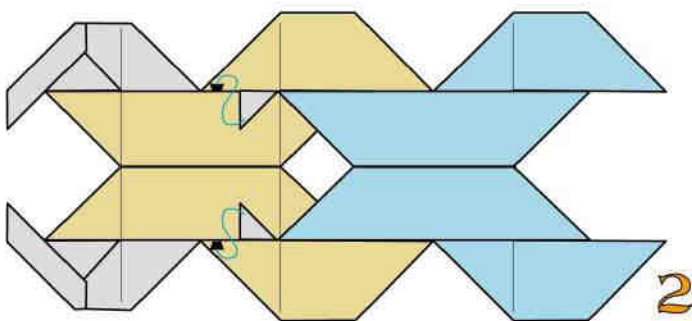

Intascate i 2 vertici indicati

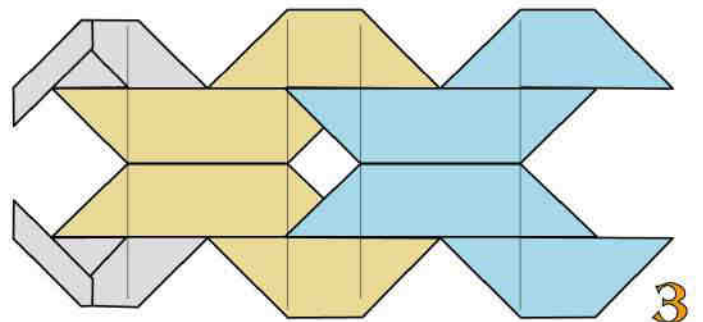

Unione di 2 moduli completata

BRACCIALE "B"

Franco Pavarin 24

Si realizza unendo 8 semipiastre e 16 gomiti Meccanorigami del mio libro: "Composizione modulare origami 1". Per le semipiastre adoperate fogli monocolori di carta di medio peso delle misure di cm 4x4 e per i gomiti cm 2x4.

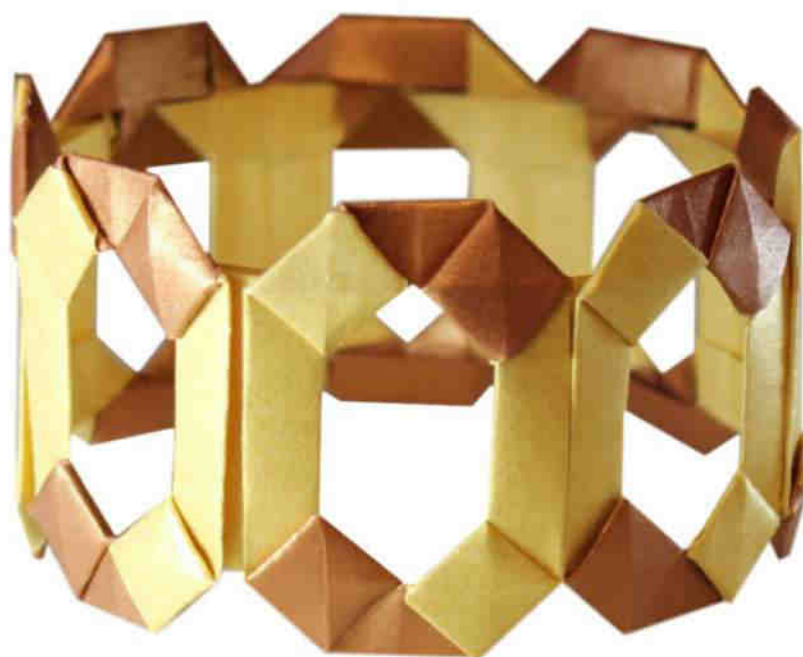

COSTRUZIONE DELLA SEMIPIASTRA

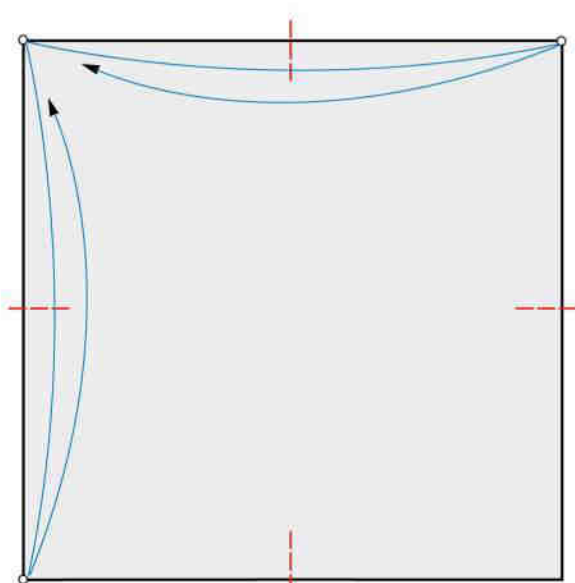

4 piccole pieghe a valle

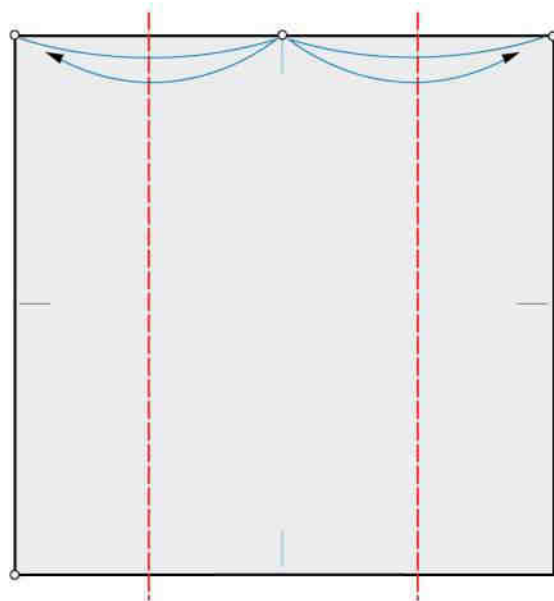

2 pieghe a valle

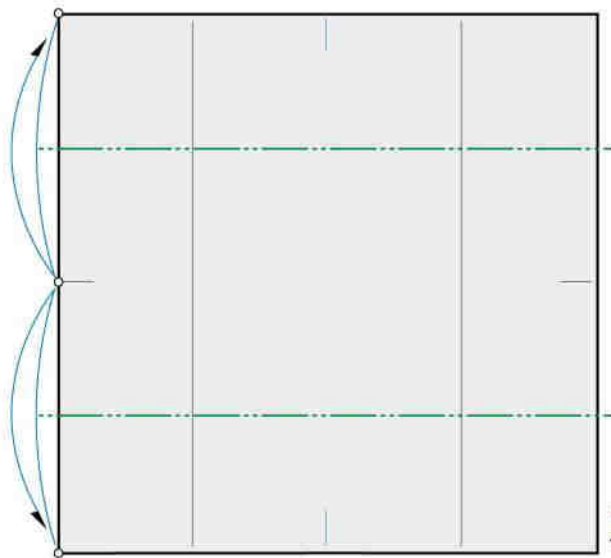

2 pieghe a monte

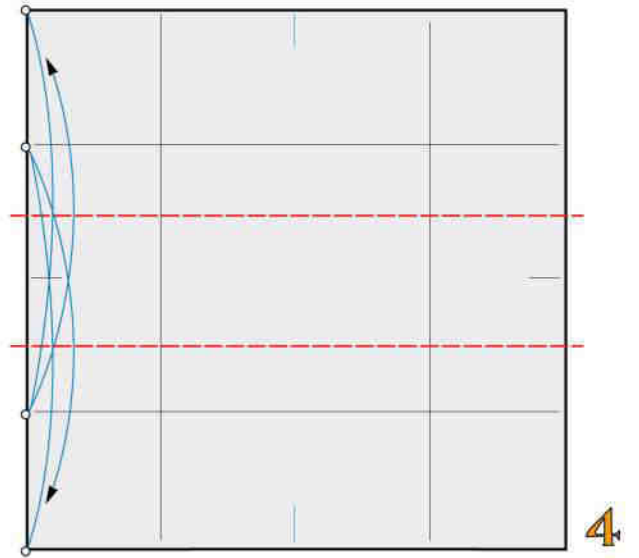

2 pieghe a valle

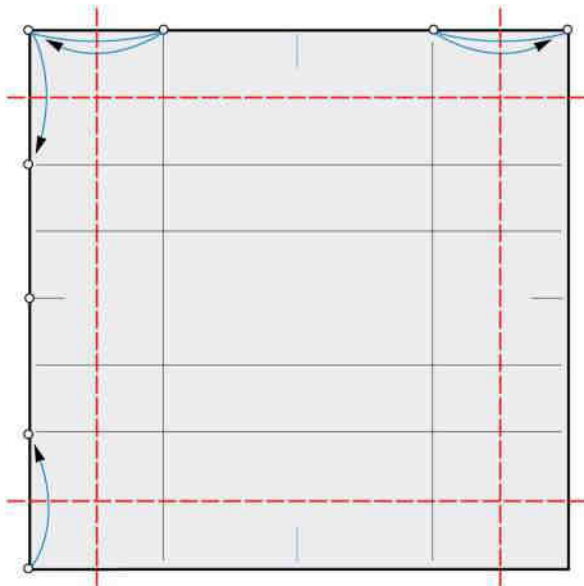

4 pieghe a valle

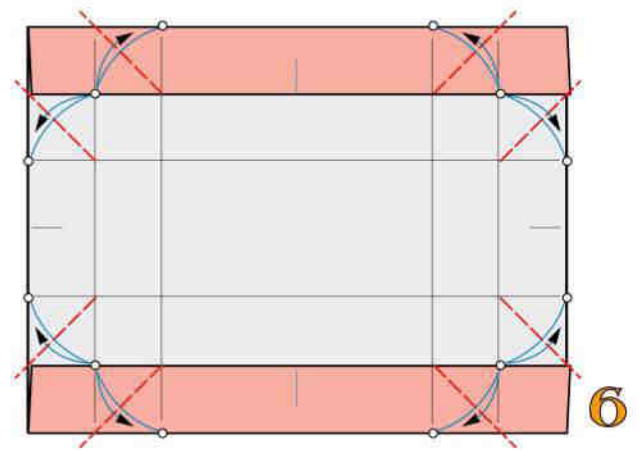

8 pieghe diagonali a valle

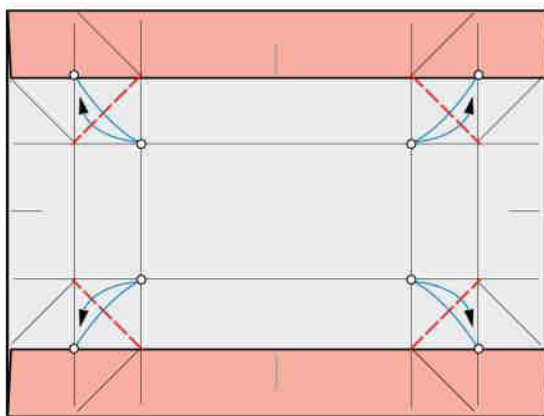

4 pieghe diagonali a valle

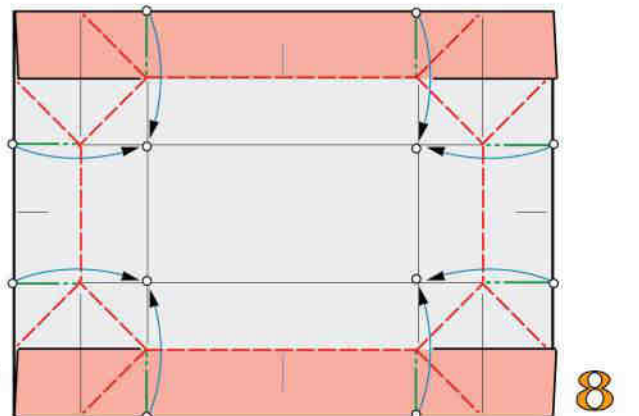

Ripiegate a valle e a monte

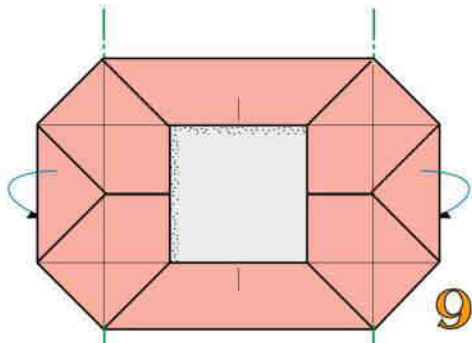

Ripiegate a monte

9

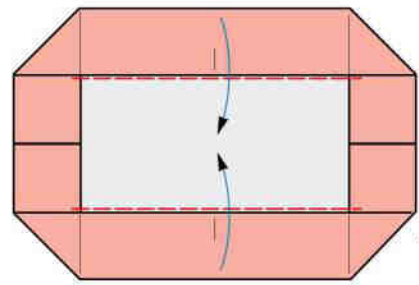

Ripiegate a valle

10

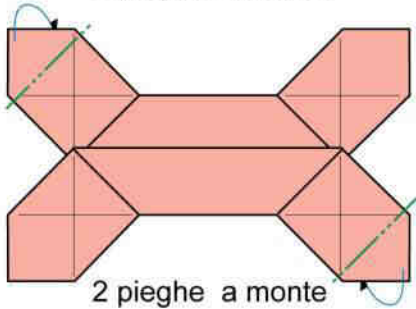

2 pieghe a monte

11

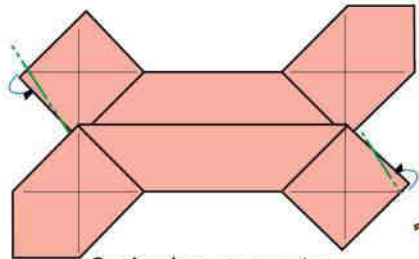

2 pieghe a monte

12

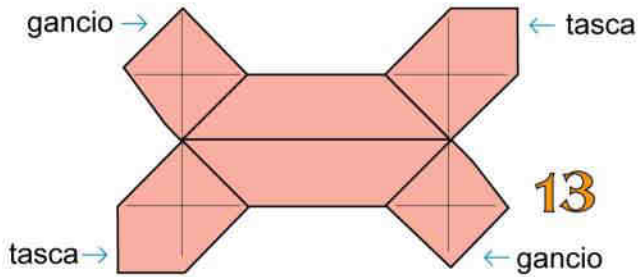

13

Semipiastra ultimata

COSTRUZIONE DEL GOMITO

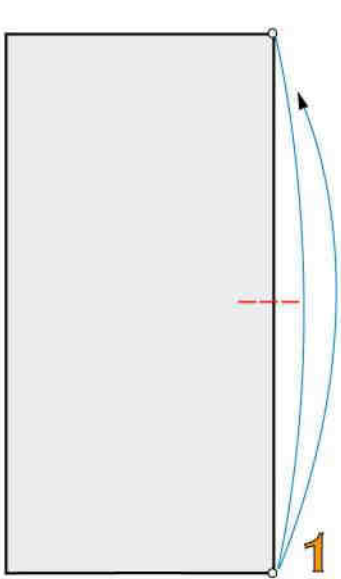

1 piccola piega a valle

1

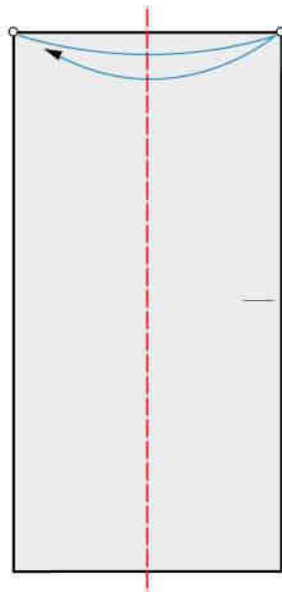

1 piega a valle

2

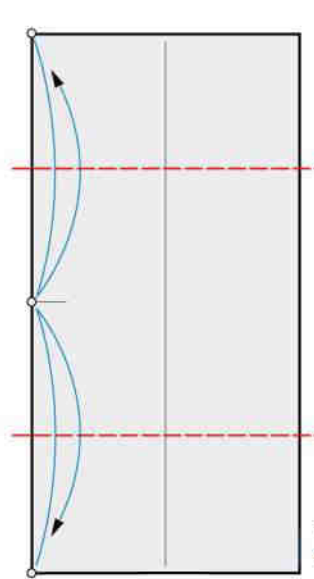

2 pieghe a valle

3

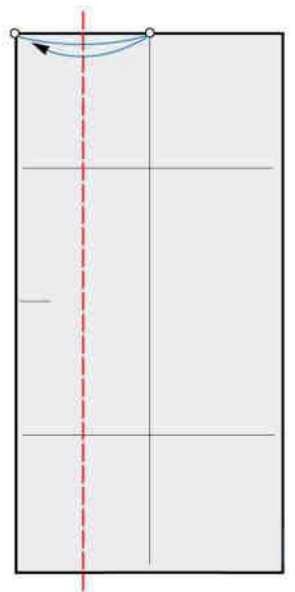

1 piega a valle

4

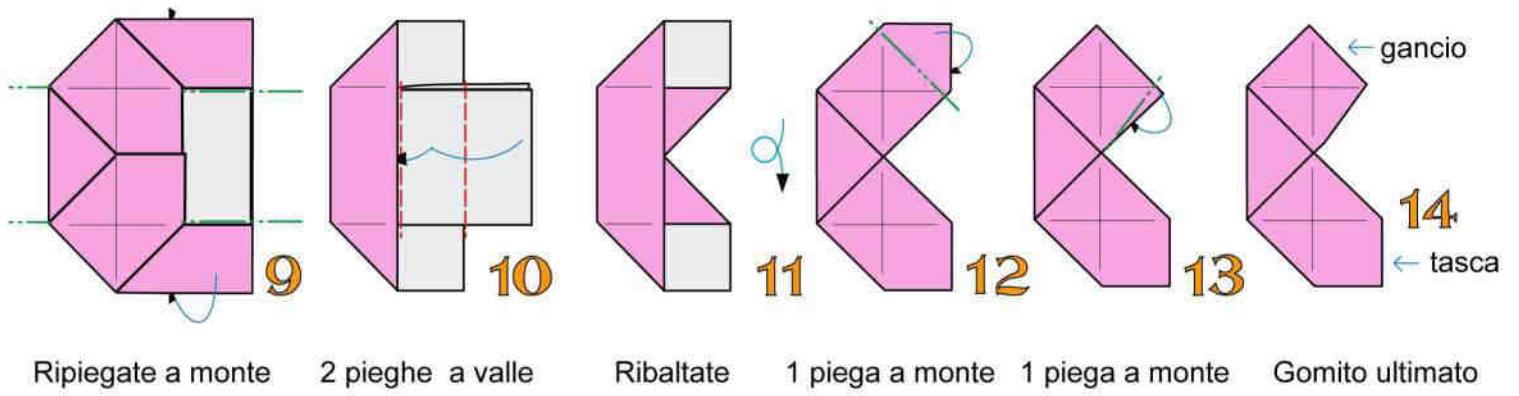
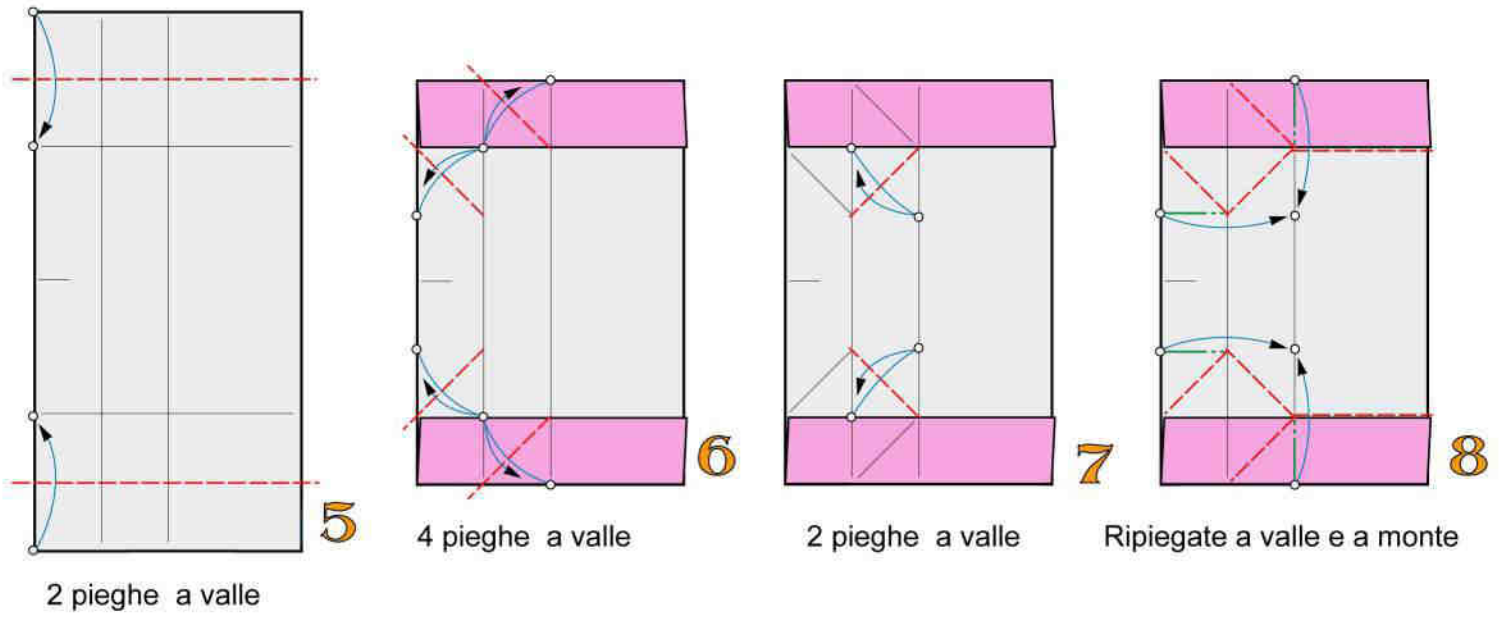

UNIONE DI 4 MODULI

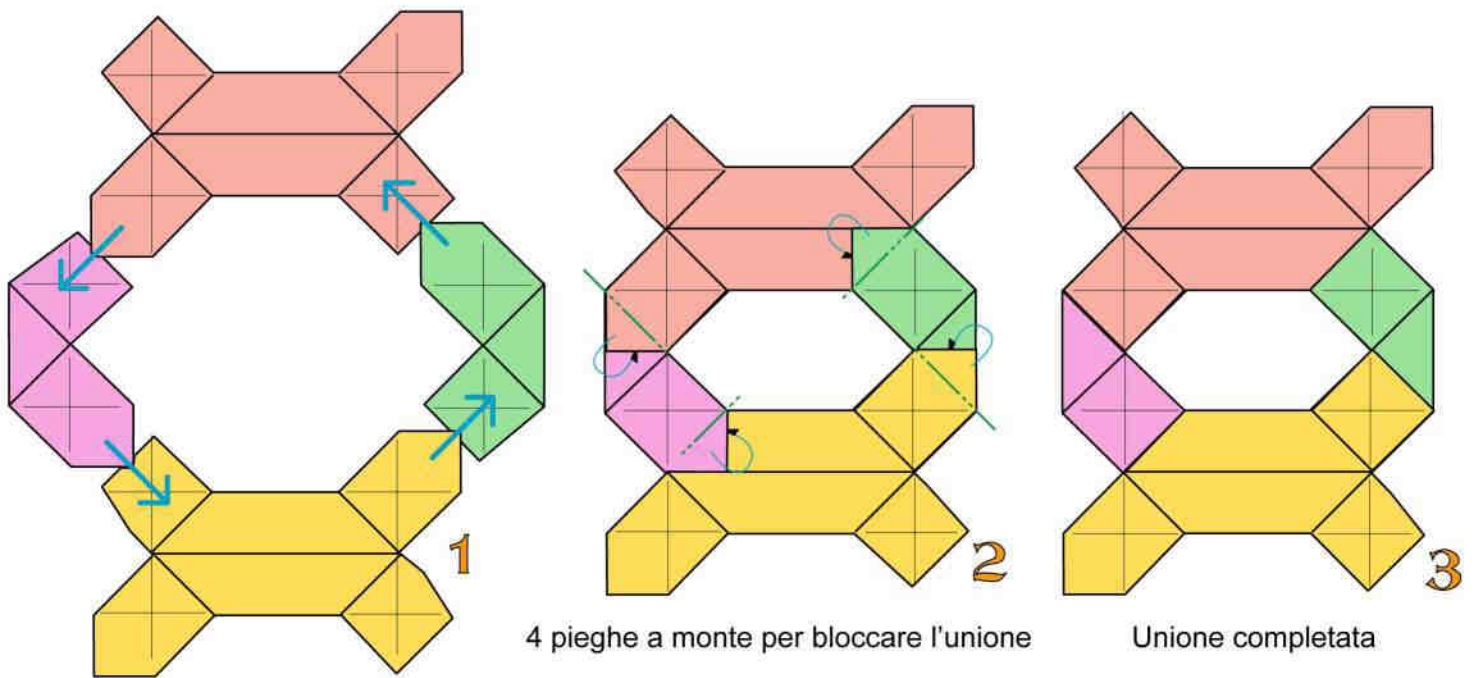

Intascate vicendevolmente un modulo nell'altro

BRACCIALE "C"

Franco Pavarin 24

Il bracciale "C" si costruisce unendo 2 nastri formati con 10 foglietti di carta di medio peso, monocolori o bicolori, delle dimensioni di cm 4x4 mediante 10 moduli di bloccaggio costruiti con foglietti delle medesime dimensioni.

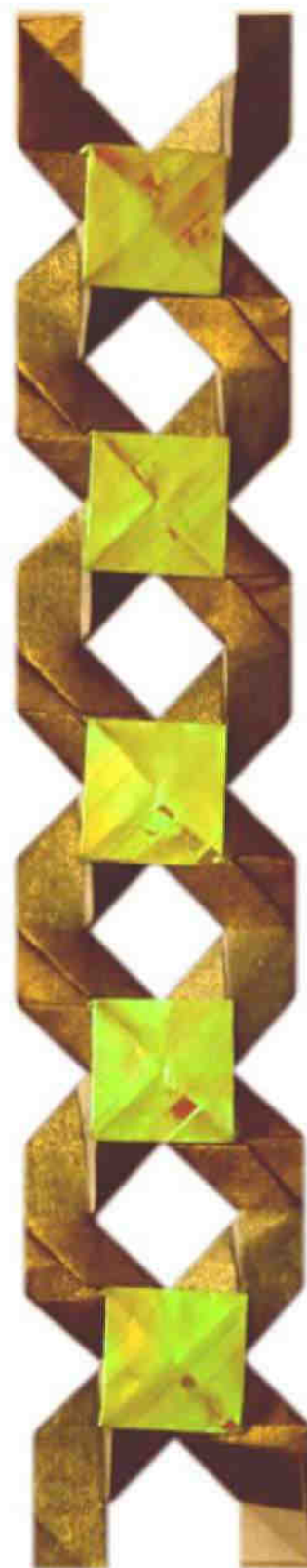
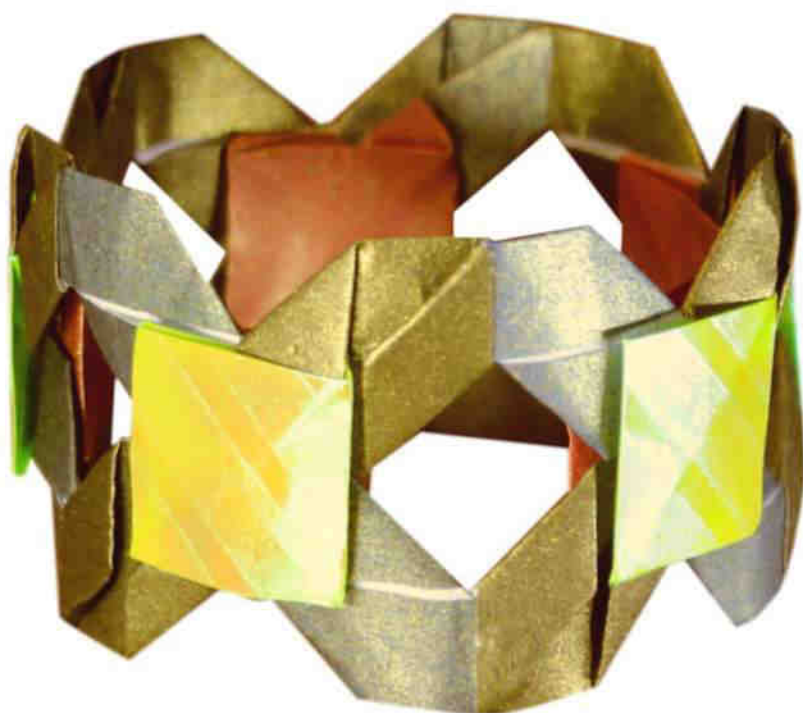

COSTRUZIONE DEL MODULO PER BRACCIALE "C"

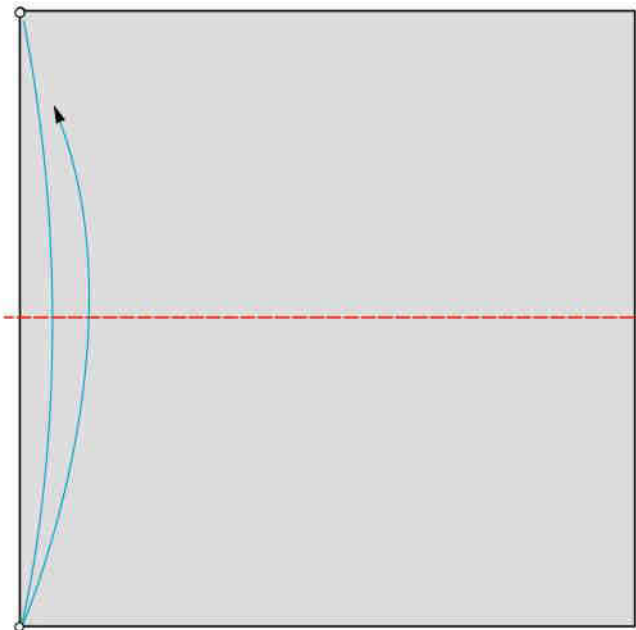

1 piega a valle

1

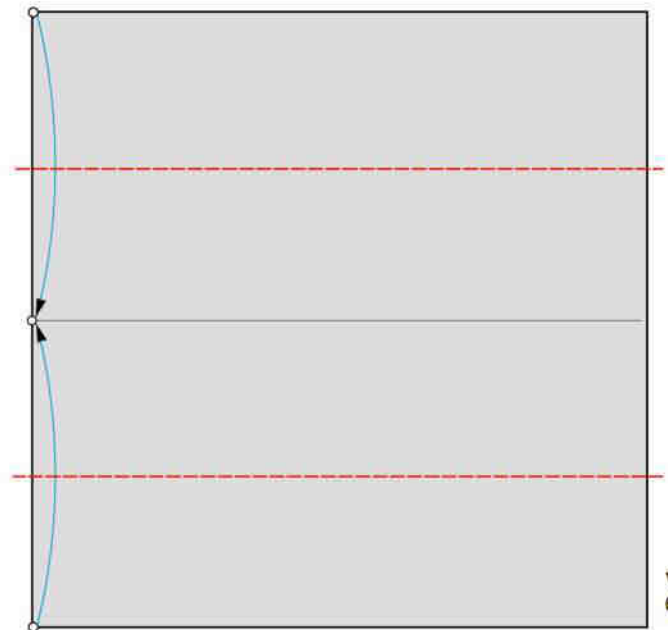

2 pieghe a valle

2

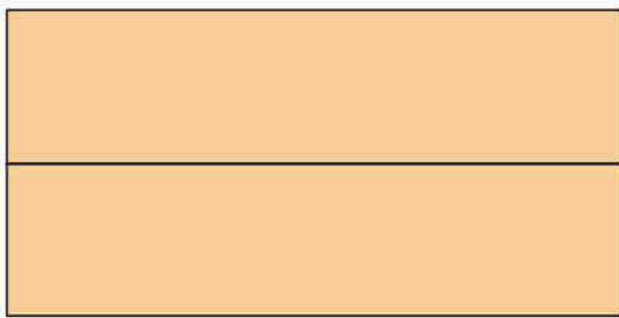

Ribaltate

3

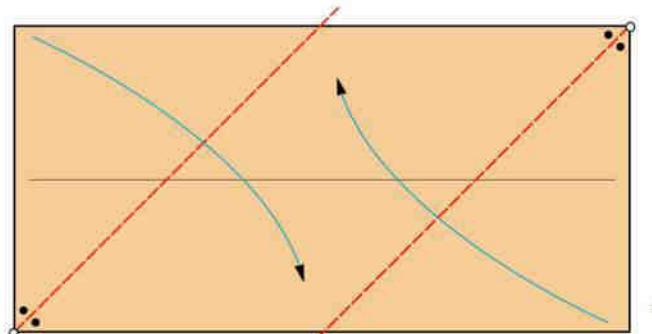

2 pieghe bisettrici a valle

4

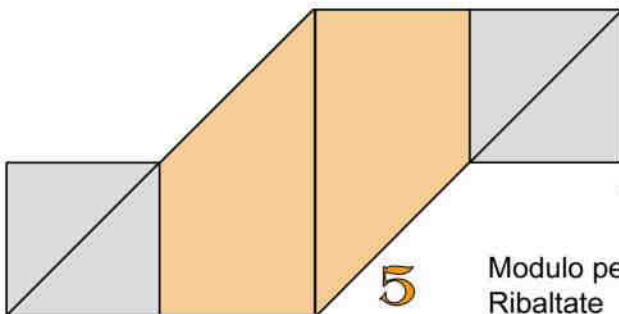

5

Modulo per bracciale "C" ultimato.
Ribaltate



COSTRUZIONE DEL MODULO DI BLOCCAGGIO

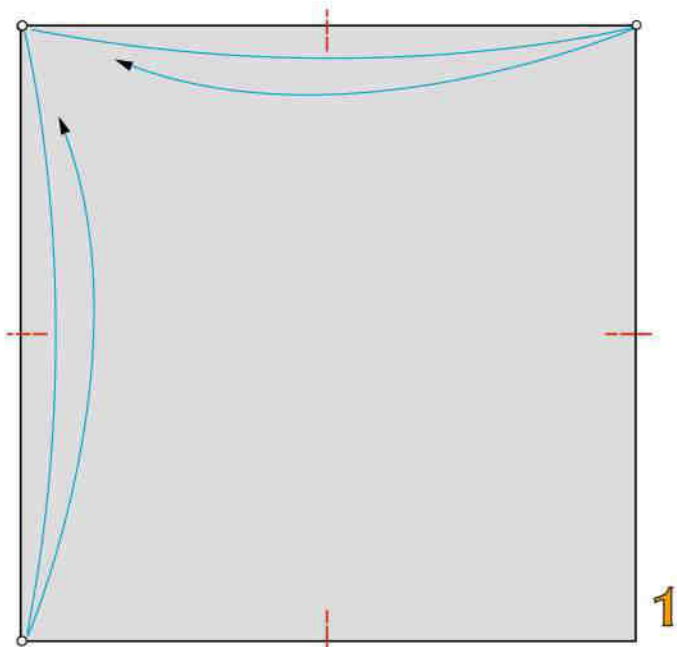

4 piccole pieghe a valle

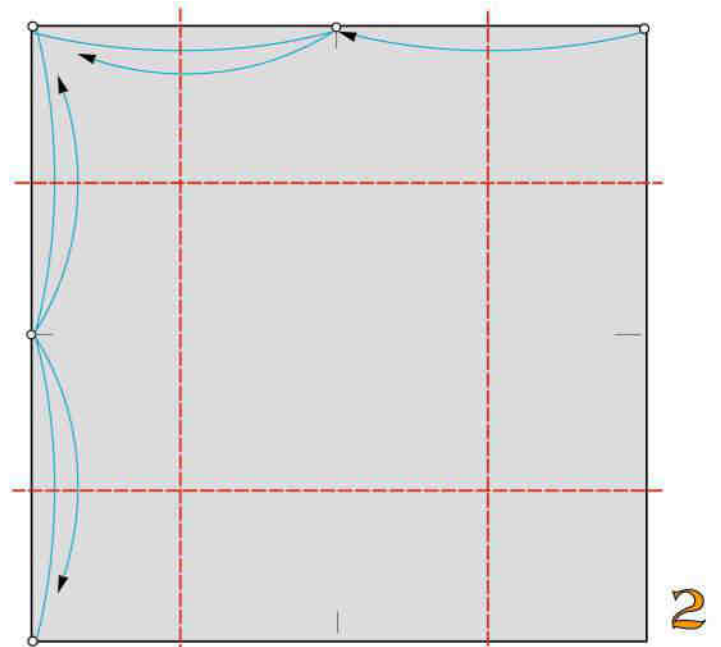

4 pieghe a valle

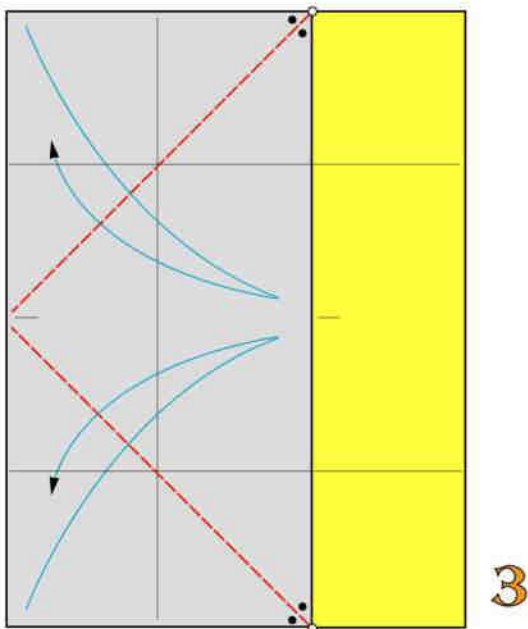

2 pieghe bisettrici a valle

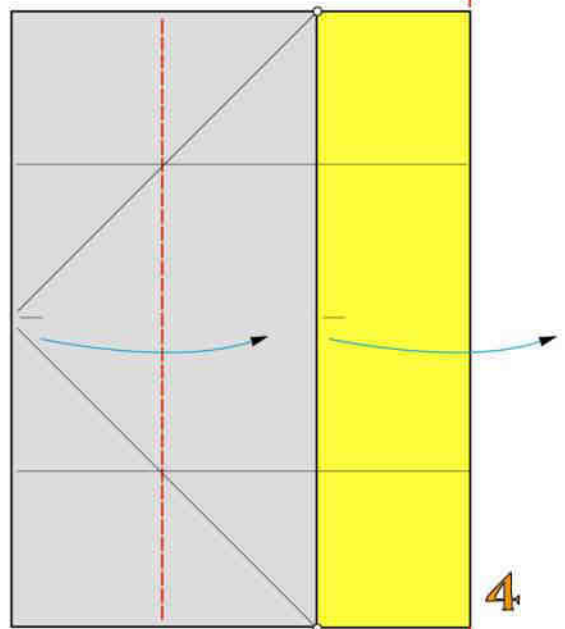

Ripiegate 2 volte a valle

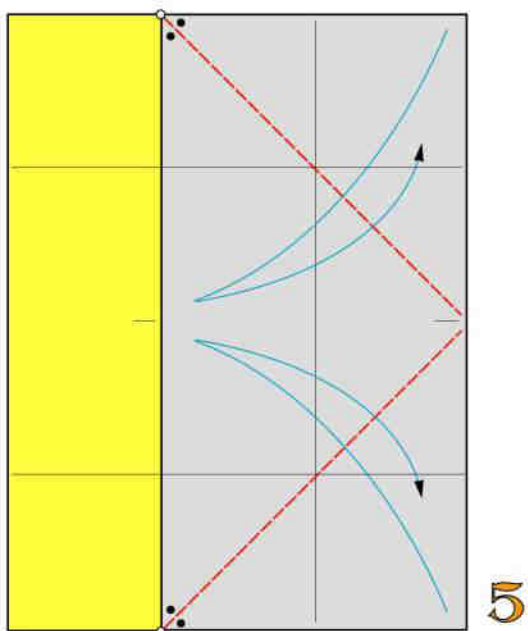

2 pieghe bisettrici a valle

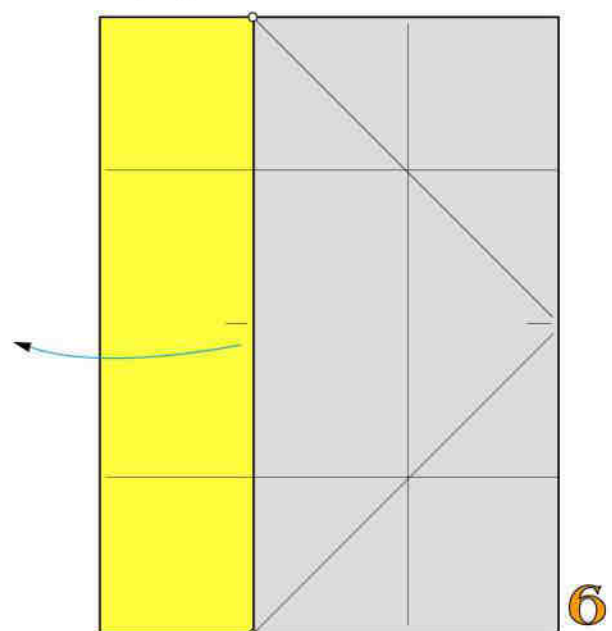

Ripiegate a valle

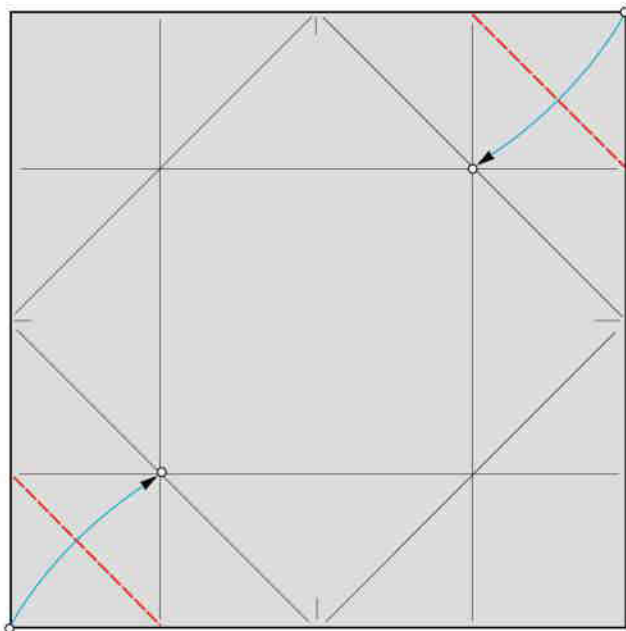

2 pieghe diagonali a valle

7

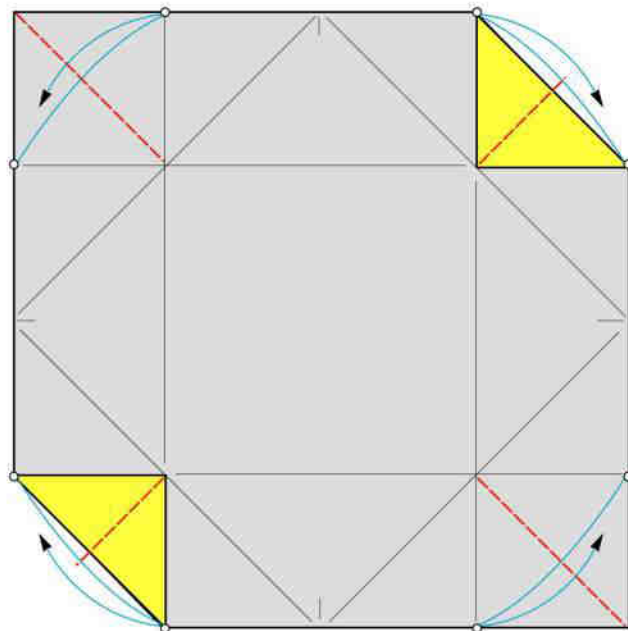

4 pieghe a valle

8

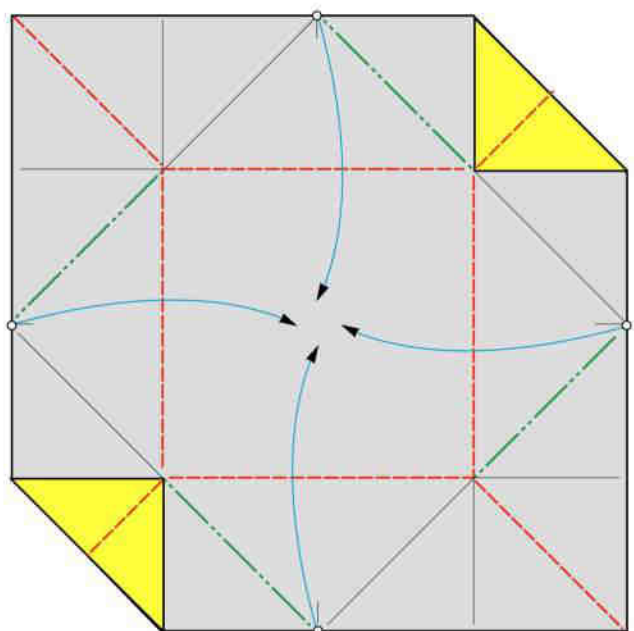

Ripiegate a valle e a monte

9

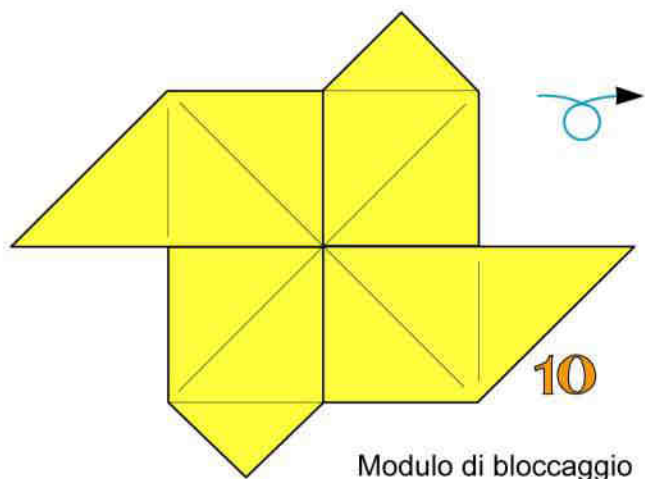

10

Modulo di bloccaggio ultimato. Ribaltate

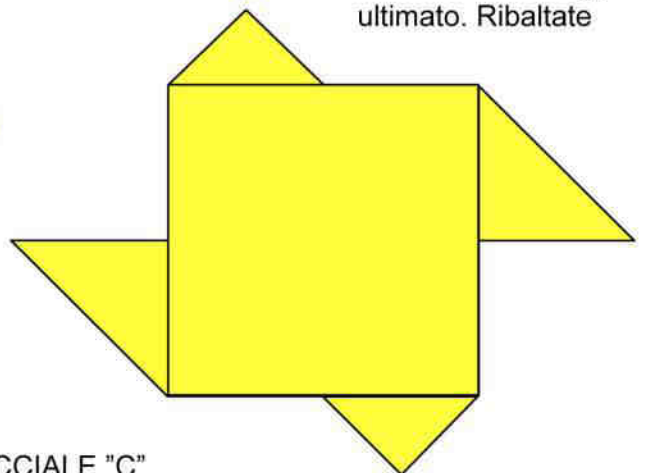

1

UNIONE DI "MODULI PER BRACCIALE "C"

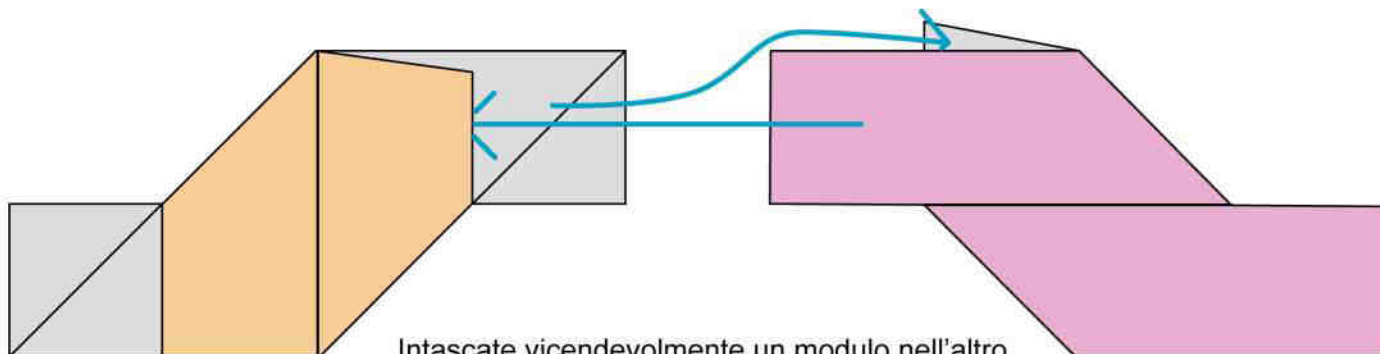

Intascate vicendevolmente un modulo nell'altro

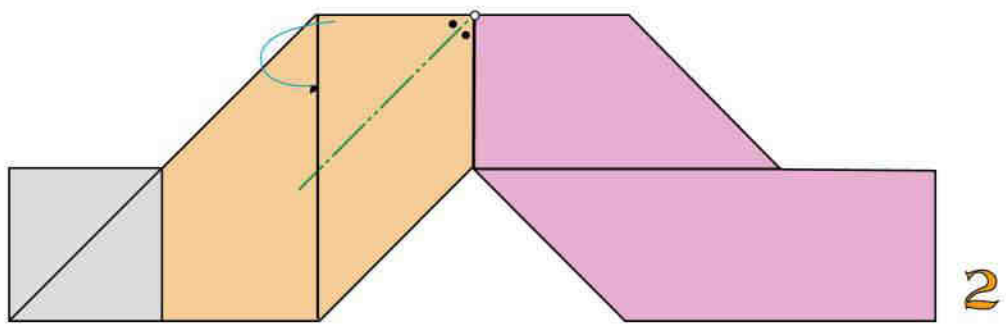

Mediante 1 piega a monte bloccate l'unione

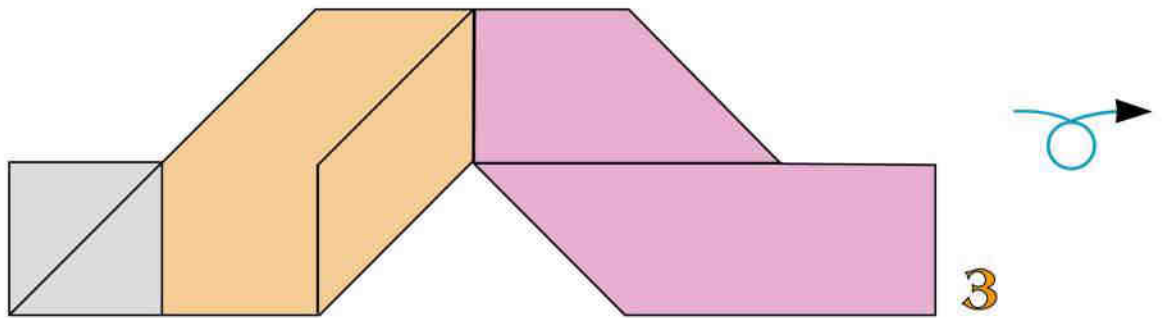

Ribaltate e ripetete il procedimento

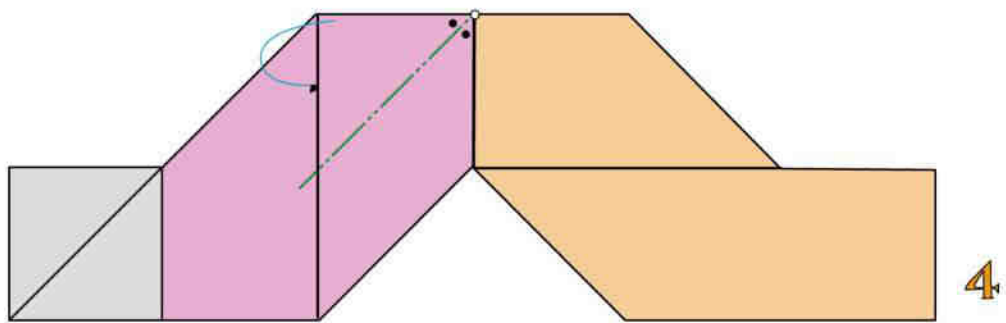

Mediante 1 piega a monte bloccate l'unione

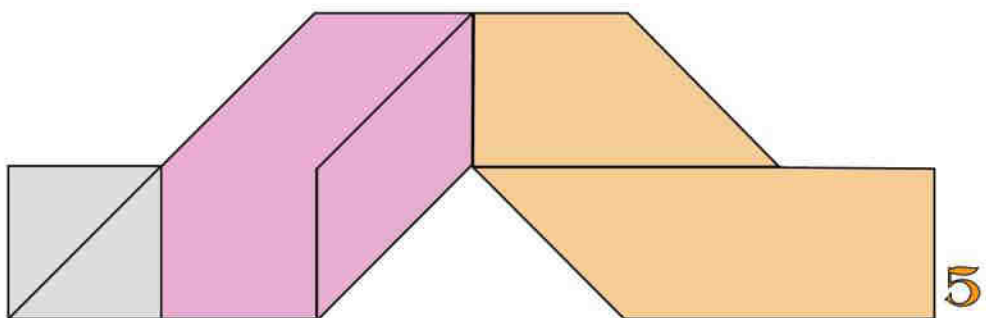

Unione di 2 moduli per bracciale "C" completata

UNIONE DI 2 MODULI PER BRACCIALE "C" CON IL MODULO DI BLOCCAGGIO

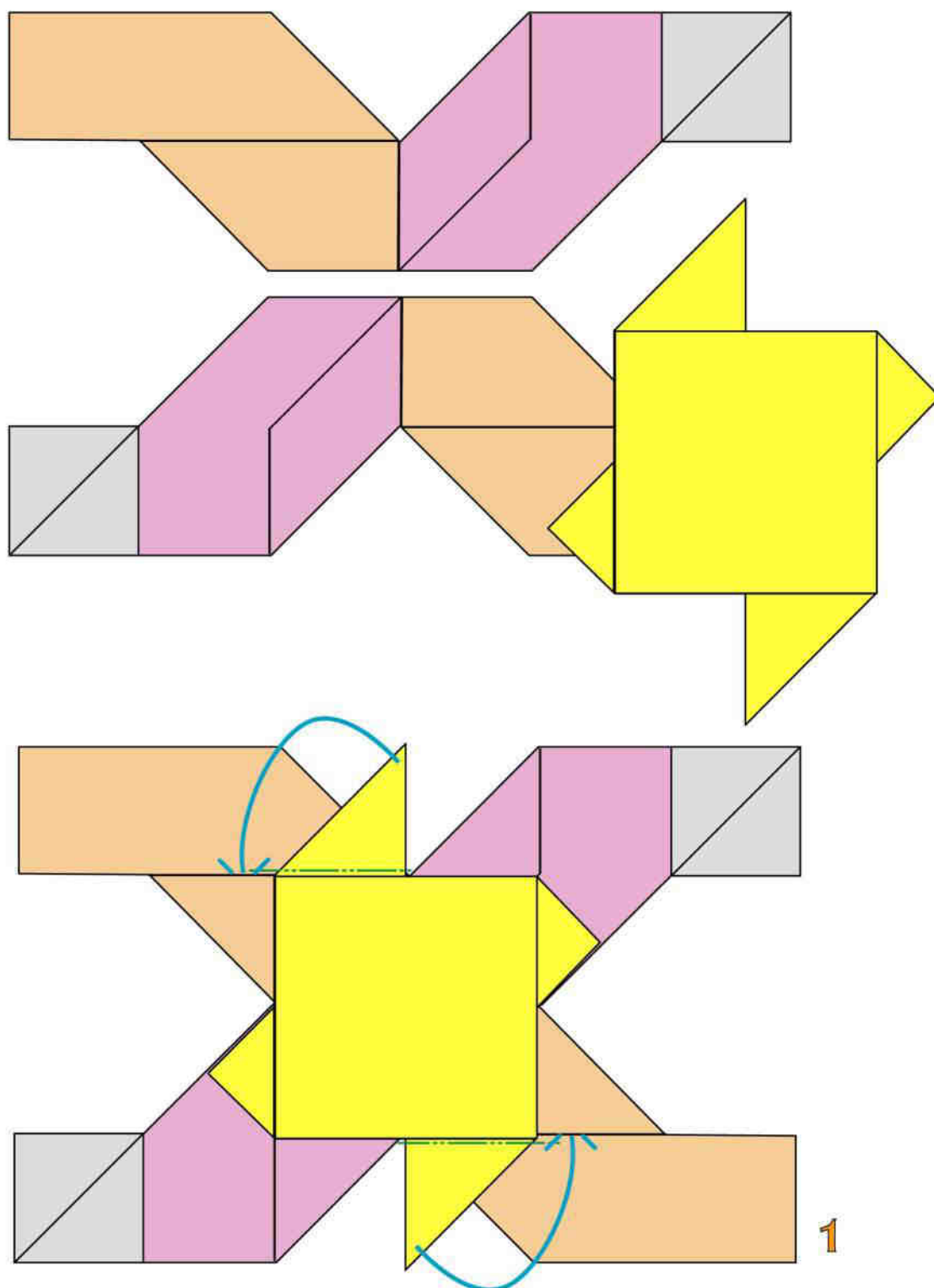

Ripiegando a monte intascate i 2 triangoli indicati

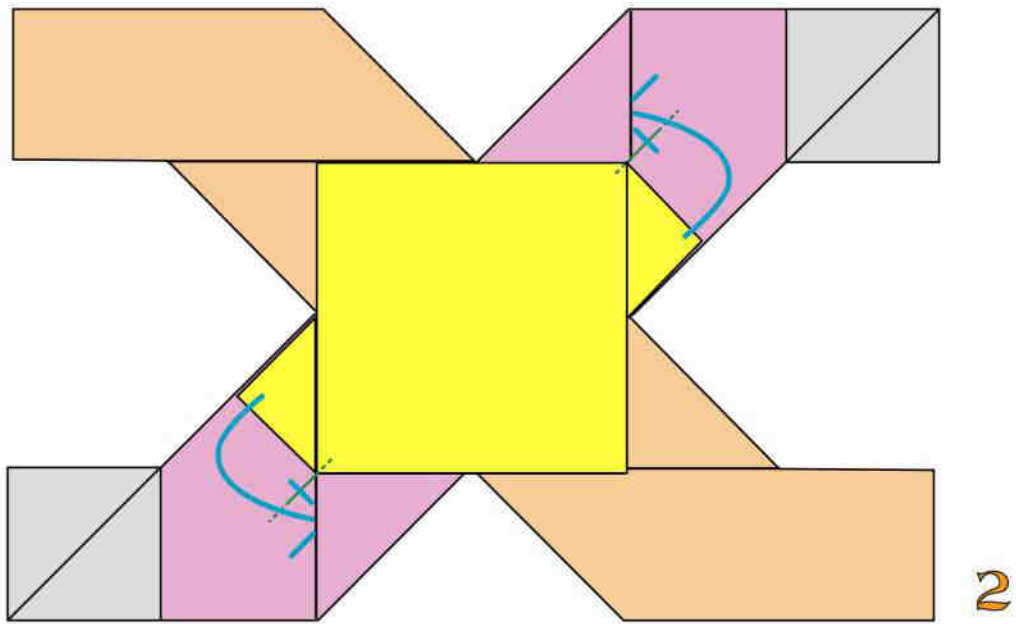

Ripiegando a monte intascate le 2 superfici sottostanti indicate

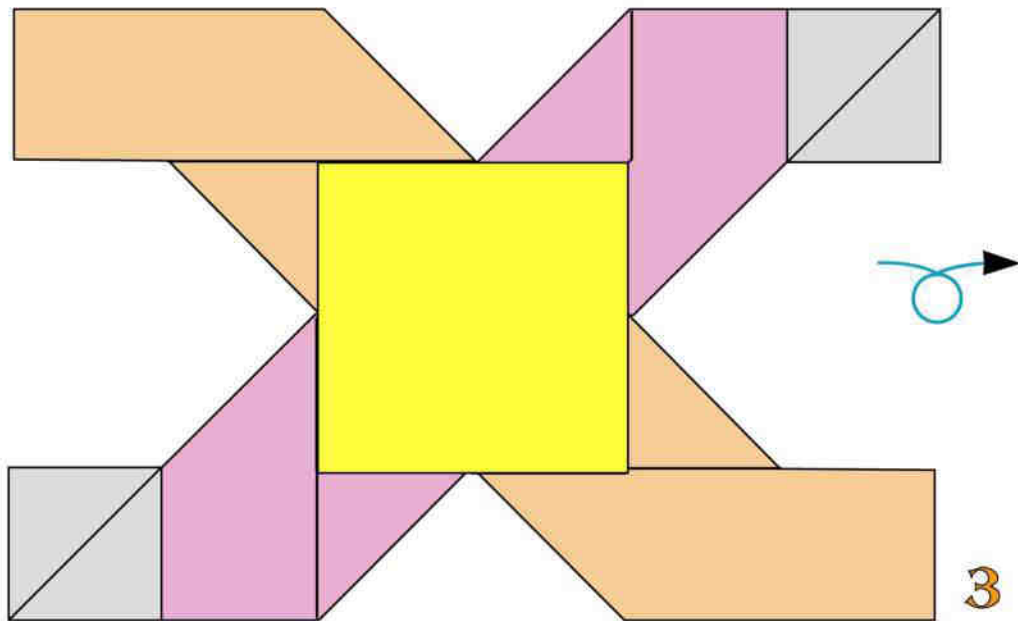

Ribaltate

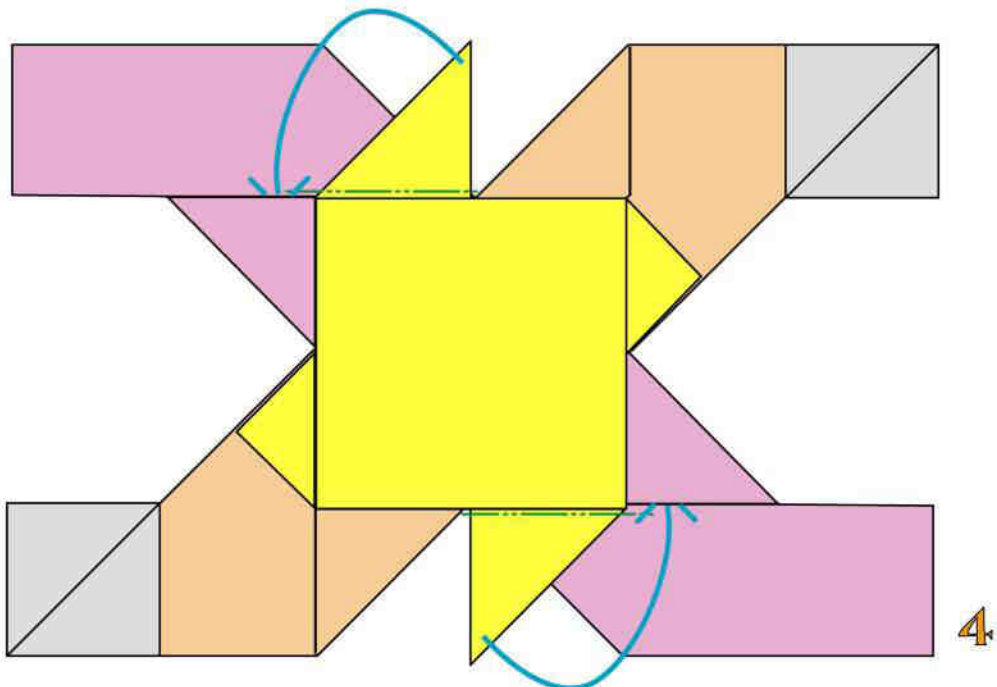

Ripetete il procedimento già visto

FESTONE 3D

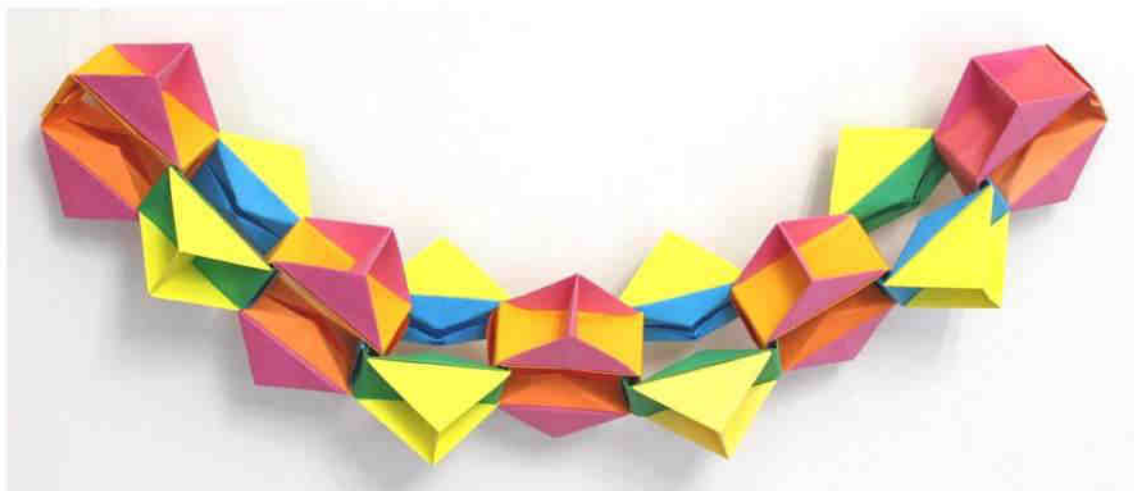

Si costruisce collegando degli anelli come fosse una catena.

Ogni anello è formato da 2 elementi da realizzare con 2 fogli quadrati, sul quale si montano 2 decorazioni prismatiche da costruire con 2 mezzi fogli quadrati, meglio se di colore differente.

COSTRUZIONE DELL'ANELLO

Adoperate quadrati di cm 21x21 ricavati da foglio A4 monocolori.

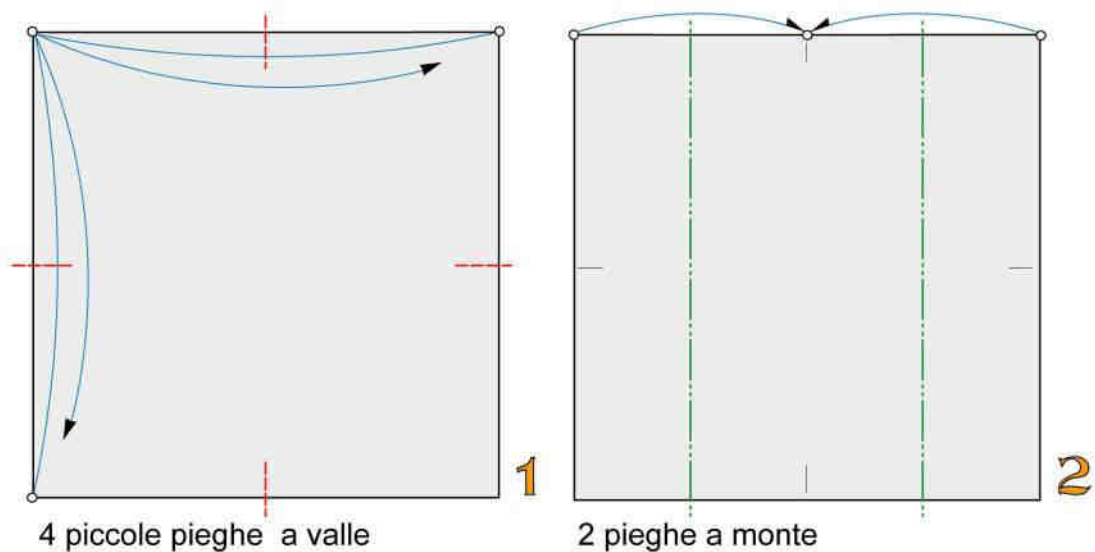

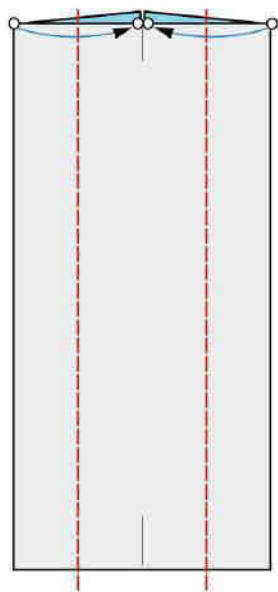

2 pieghe a valle
solo sulla sup. in
vista

3

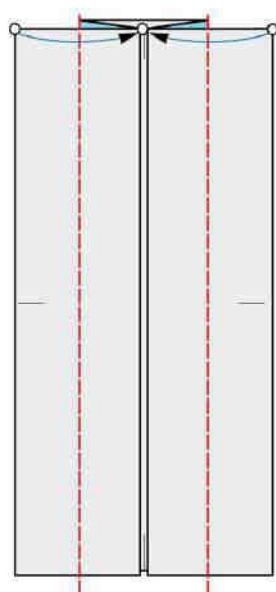

2 pieghe a valle

4

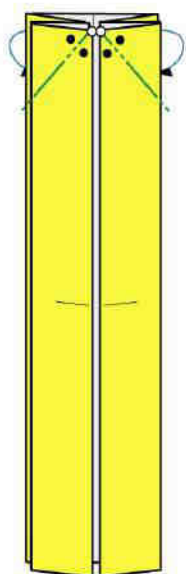

5

2 pieghe bisettrici
a monte

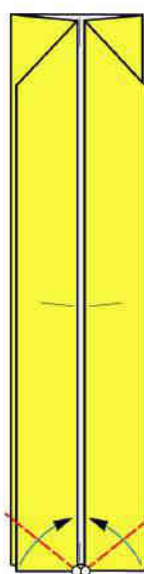

6

2 pieghe che non sono
bisettrici a monte

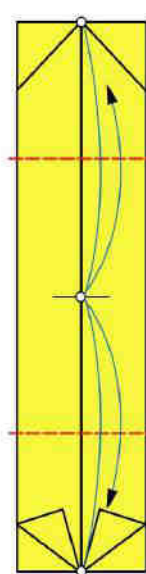

7

2 pieghe a valle

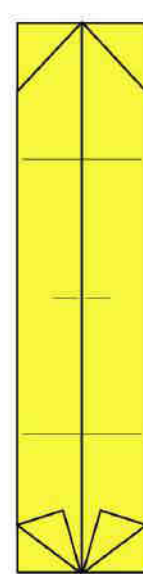

8

Modulo catena
ultimato

COSTRUZIONE DELL' ACCESSORIO

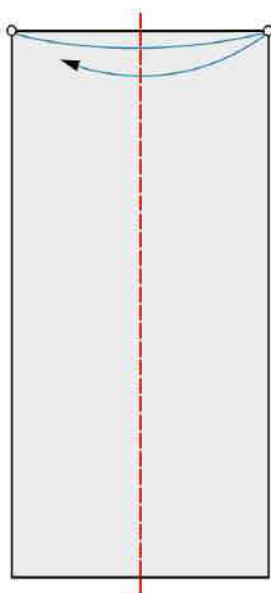

1

1 piega a valle

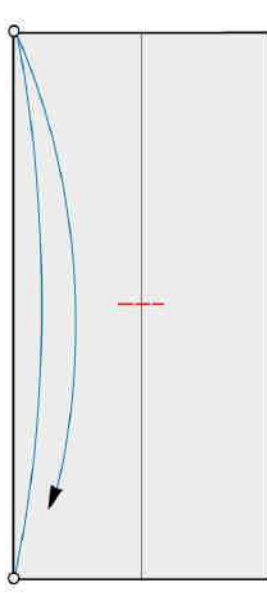

2

1 piccola piega a valle

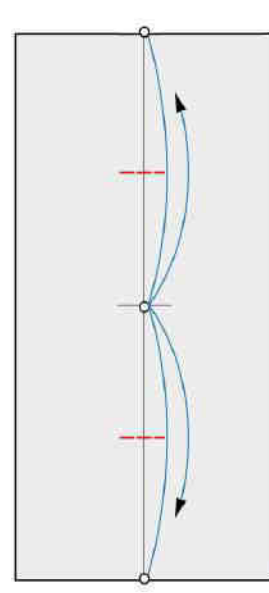

3

2 piccole pieghe a valle

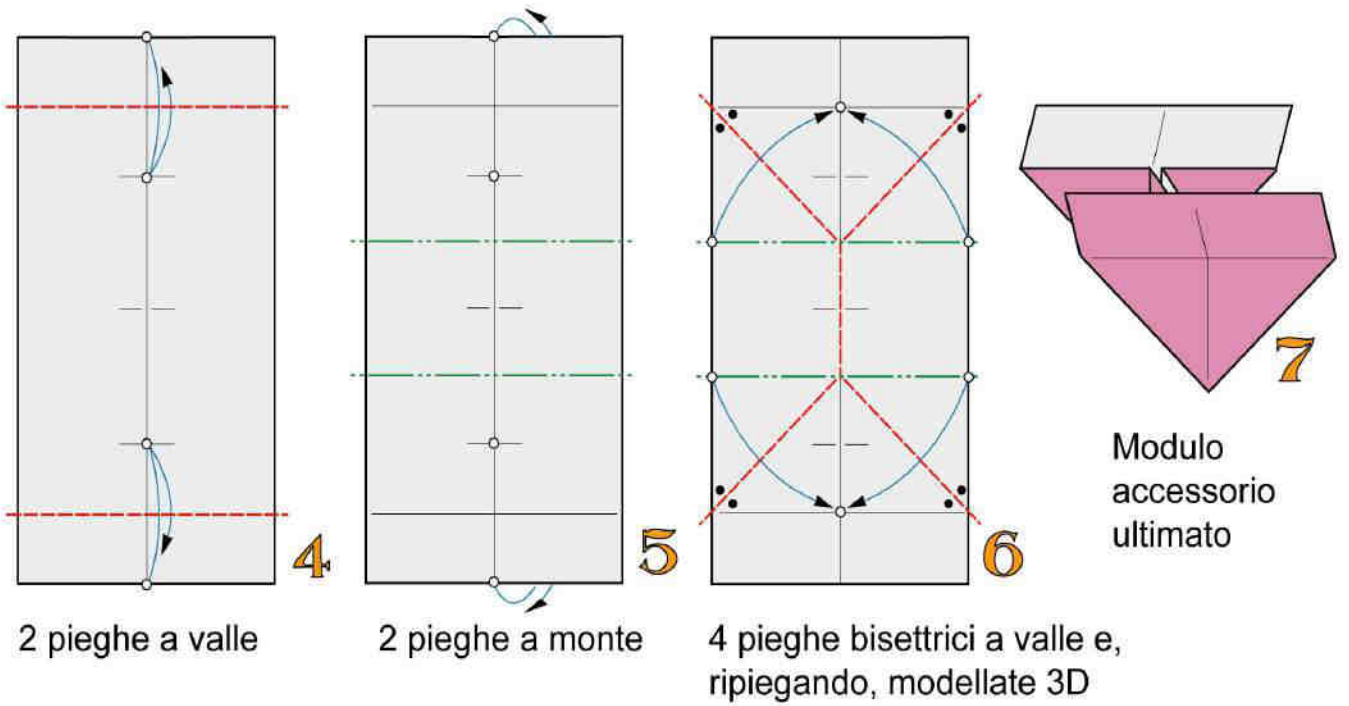

MONTAGGIO DELL' ANELLO

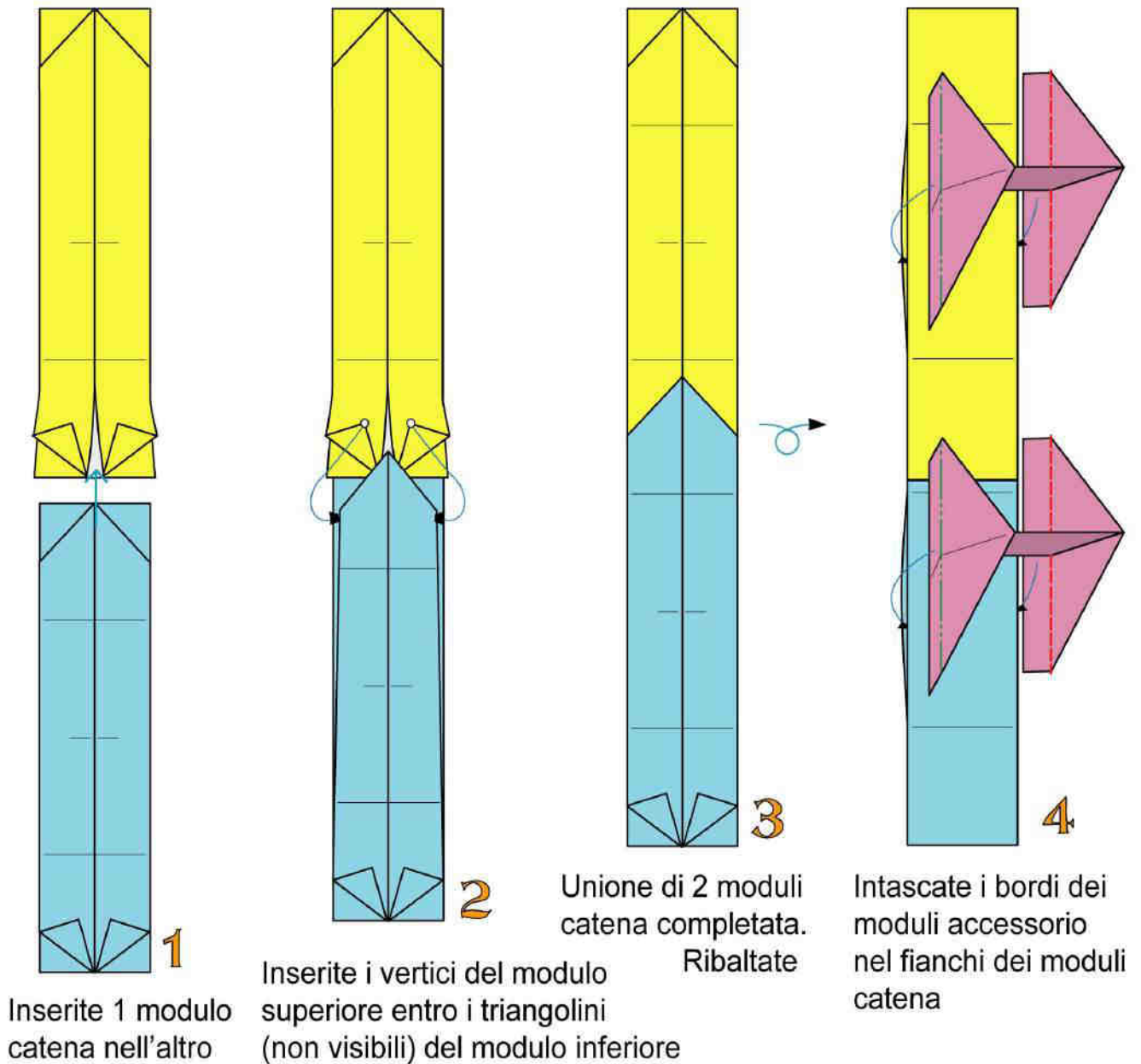

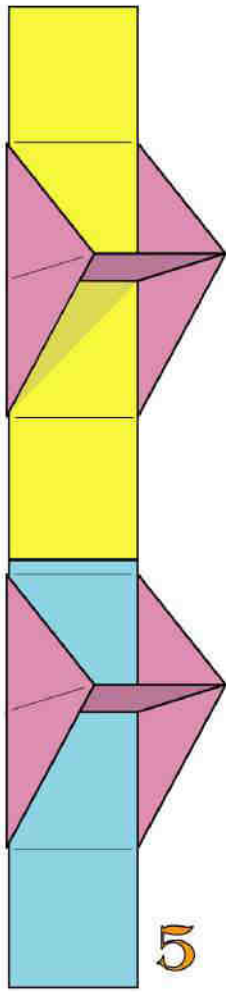

5

Ribaltate

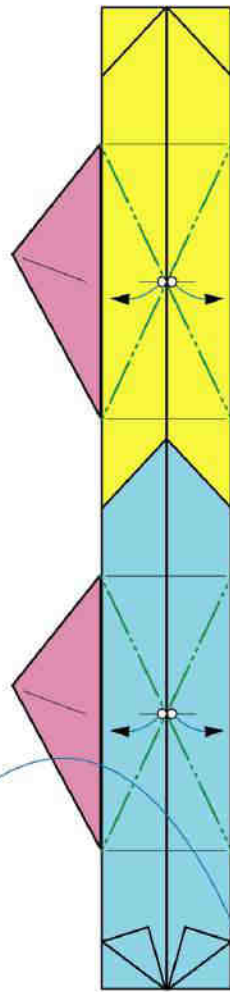

6

Eseguite le pieghe a monte
necessarie per bloccare
l'unione aprendo 3D

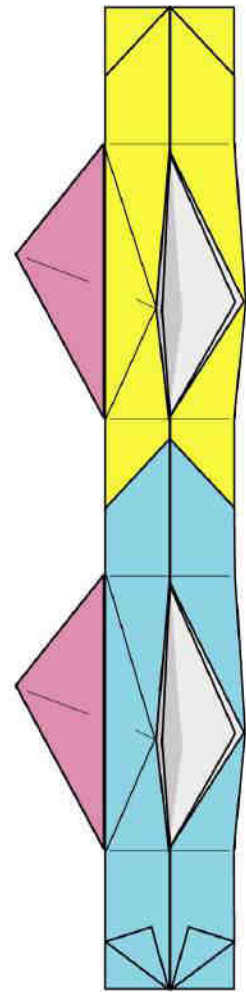

7

Anello catena
aperto ultimato

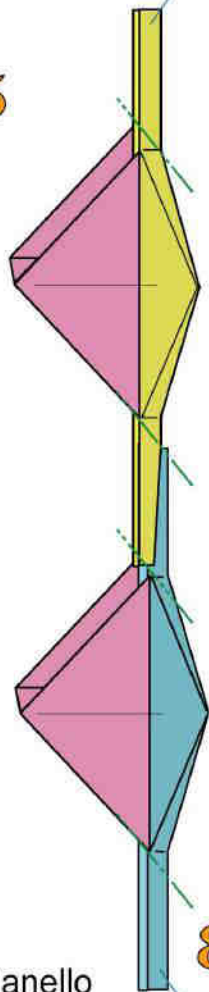

8

Fianco: chiudete l'anello
catena come già visto
nella pagina precedente

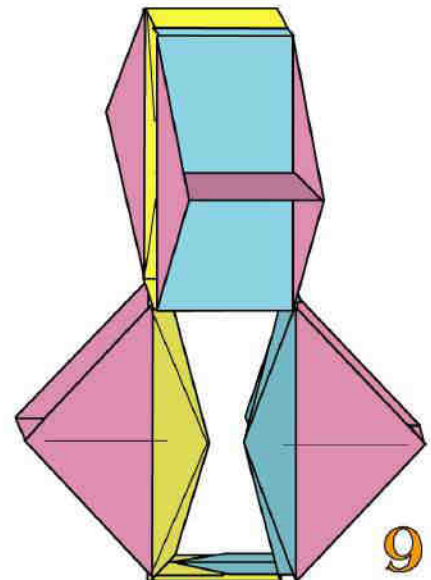

9

2 anelli collegati

ORECCHINI PENDENTI!

DANGLE EARRINGS - PENDIENTES COLGANTES

Franco Pavarin 2020

Adoperate 3 fogli di carta metallizzata delle dimensioni di cm 4x2.

Completata l'unione dei moduli immergete in un liquido indurente come "Crystal resin" o smalto per unghie.

Ricordo che Vanda Battaglia è uno dei maggiori esperti del settore.

Questo modulo e le sue varianti possono essere utilizzati per la costruzione di molti poliedri traforati

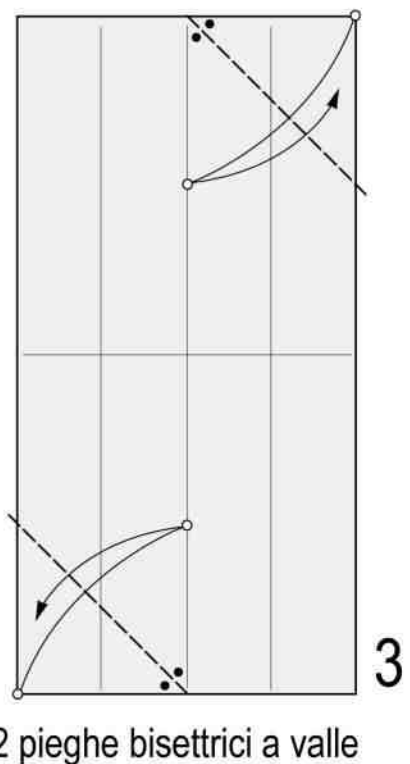
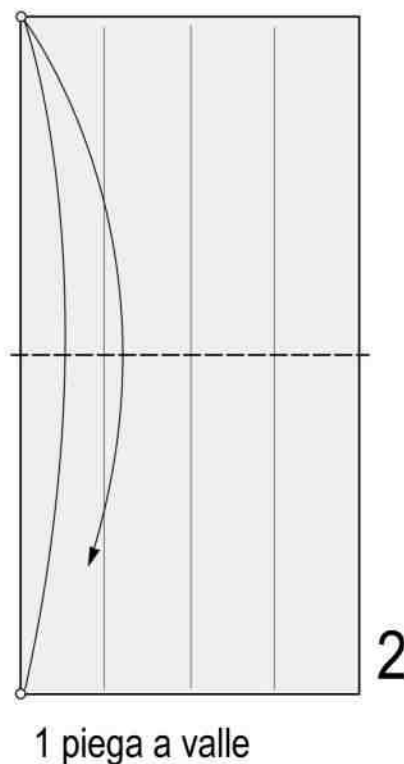
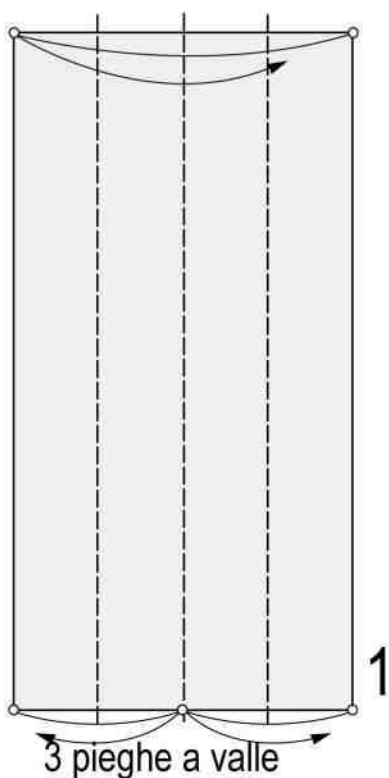
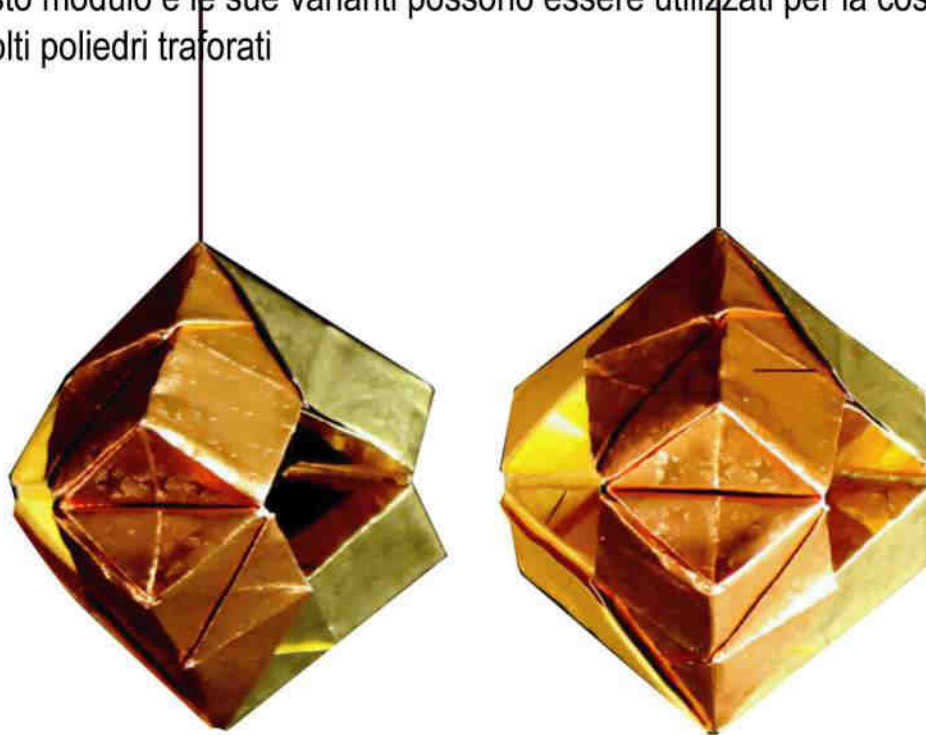

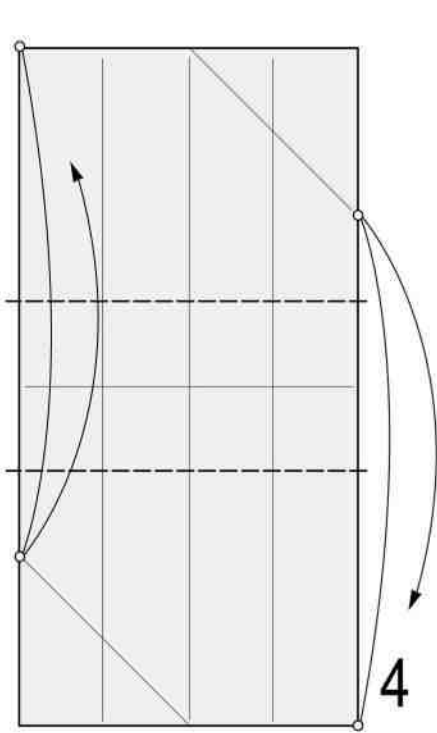

2 pieghe a valle

4

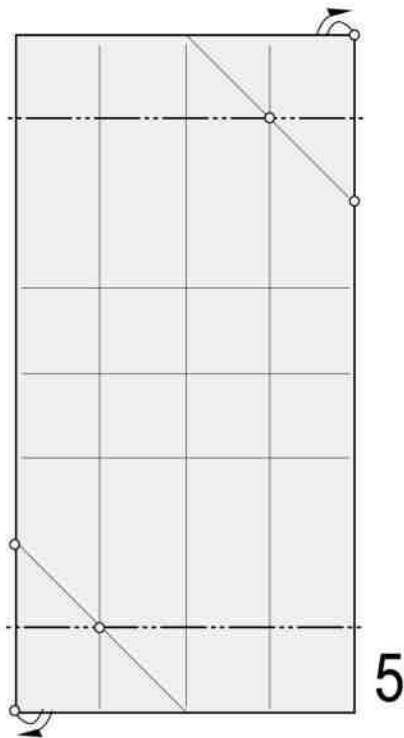

2 pieghe a monte

5

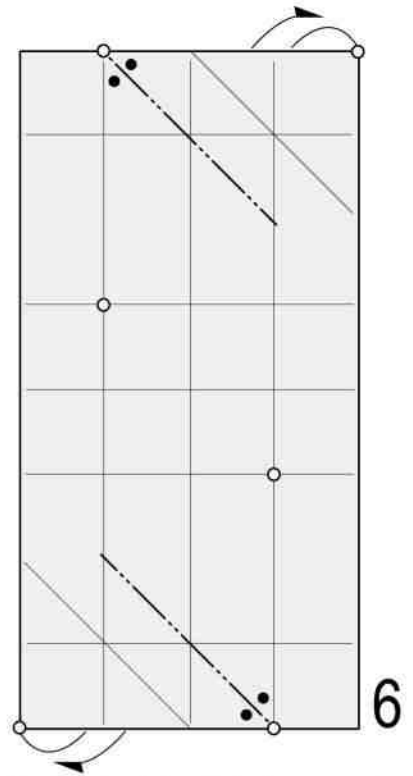

2 pieghe bisettrici a monte

6

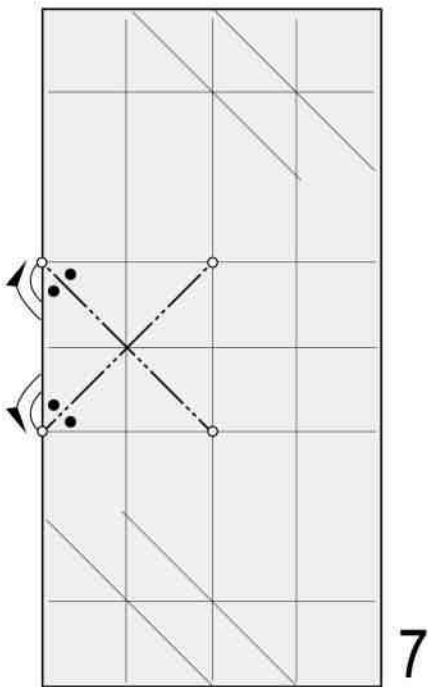

2 pieghe bisettrici a monte

7

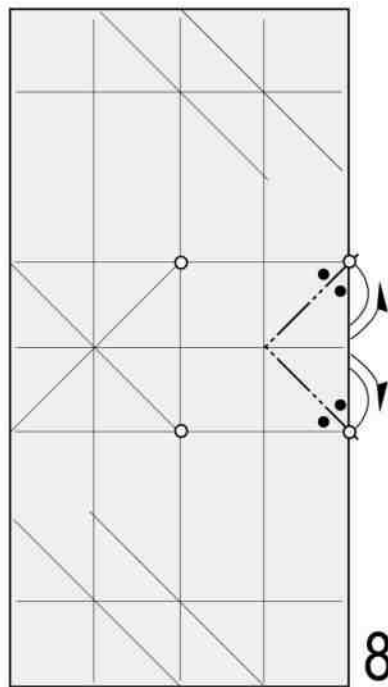

2 pieghe bisettrici a monte

8

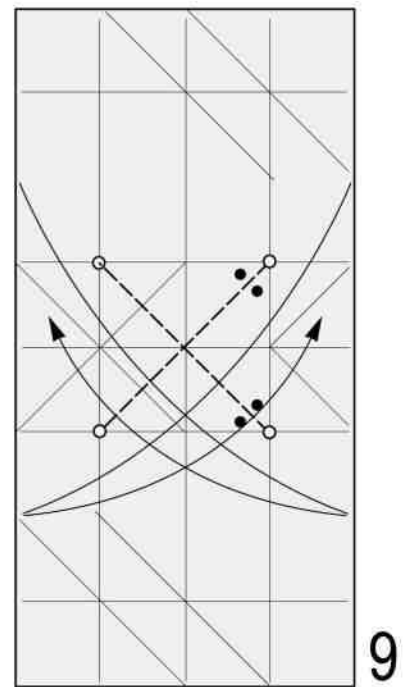

2 pieghe bisettrici a valle

9

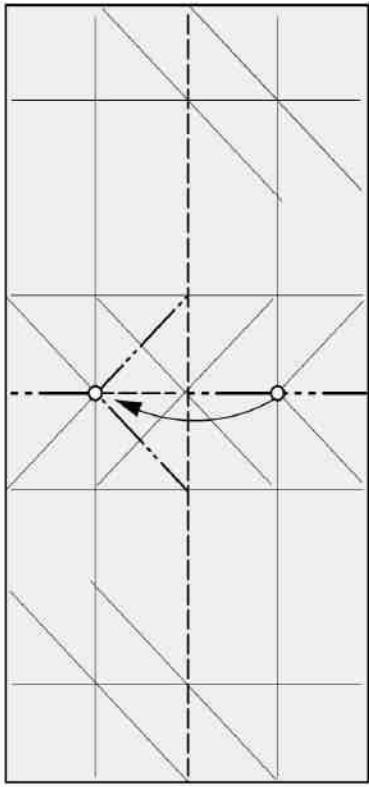

10

Ripiegando a valle ed a monte ruotate 3D

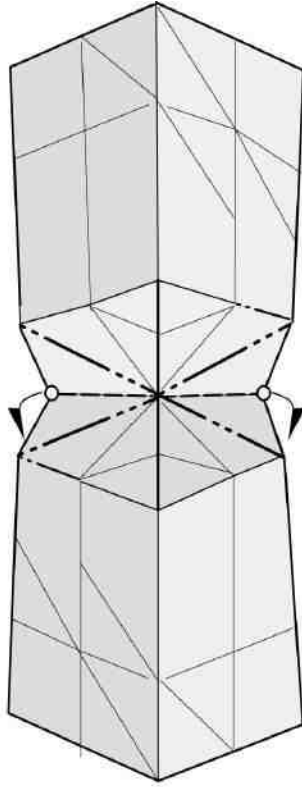

11

2 pieghe rovesce interne per abbassare i vertici

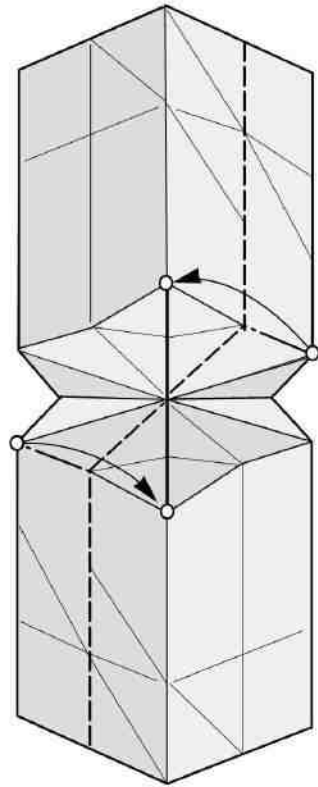

12

Piegate a valle il bordo superiore destro e quello inferiore sinistro

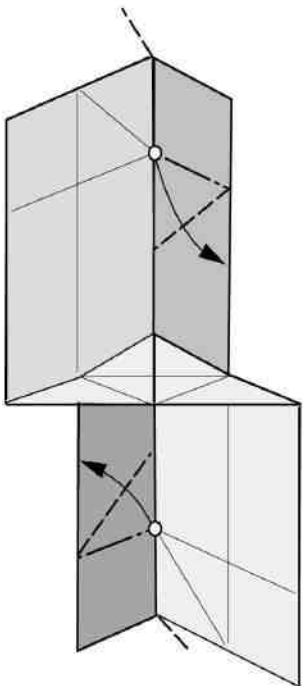

13

Ruotate ripiegando a monte ed a valle

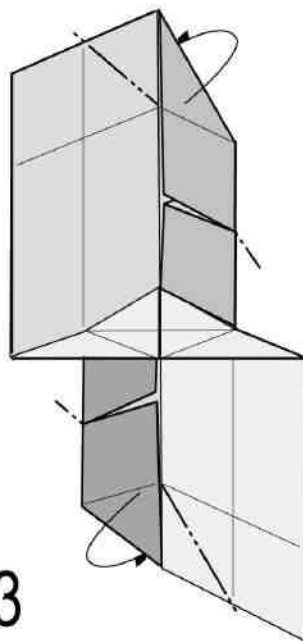

14

2 pieghe a monte

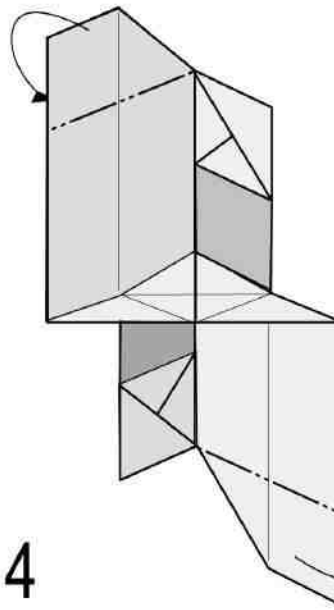

15

2 pieghe a monte

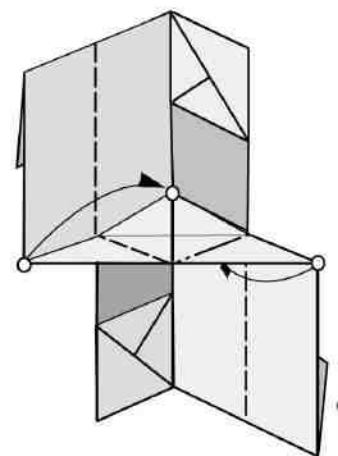

16

Piegate a valle il bordo superiore sinistro e quello inferiore destro

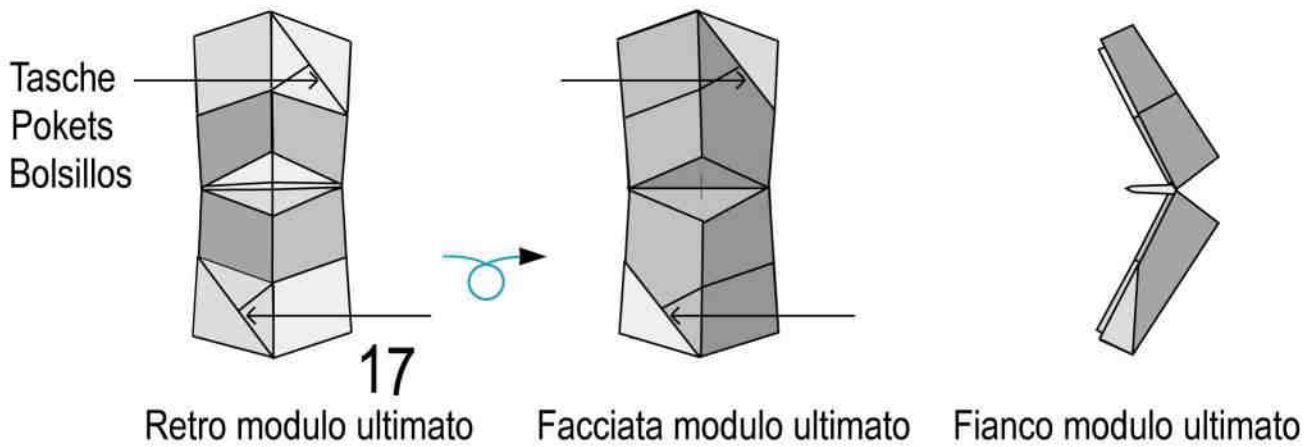

UNIONE DEI MODULI

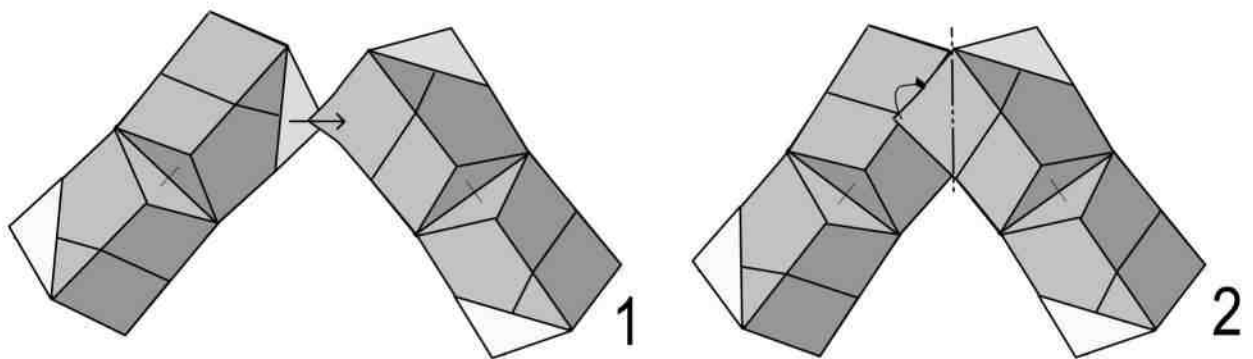

Inserite un vertice di un modulo
nella tasca dell'altro

Mediante una piega a monte
intascate bloccando liunione

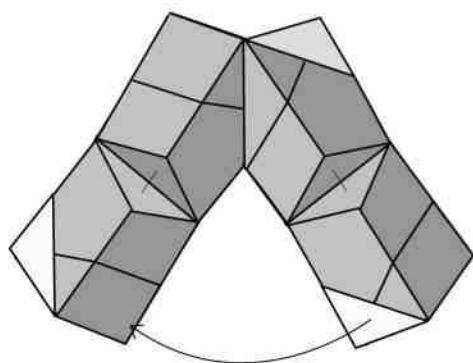

Nello stesso modo intascate
inferiormente

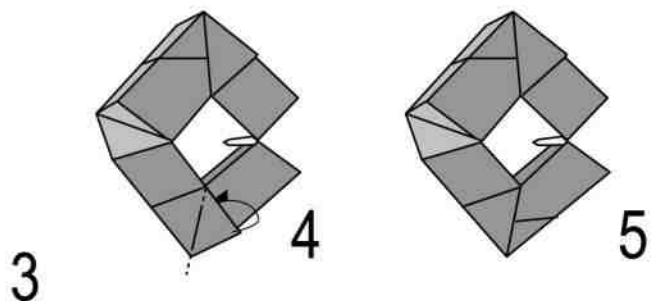

Mediante una piega
a monte intascate
bloccando liunione

2 moduli uniti.
Nello stesso modo
aggiungete e
bloccate il terzo
modulo

ORECCHINI 2 TRAFORATI

Si realizzano con 6 moduli per "Orecchini 2", costruiti con fogli monocolori di medio peso delle dimensioni di cm 5x5 e 12 moduli di bloccaggio specifici delle dimensioni di cm 2,5 x2,5

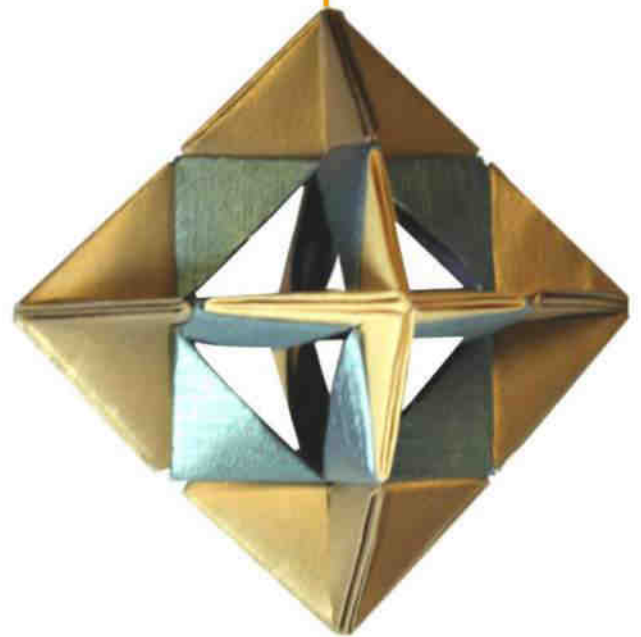
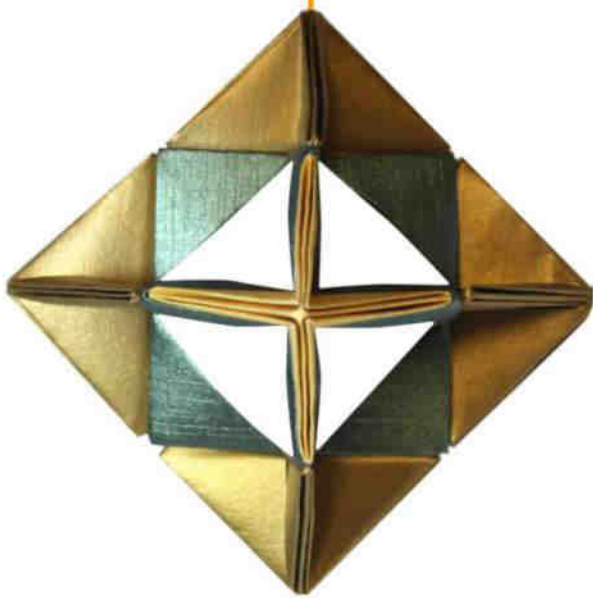

COSTRUZIONE MODULO ORECCHINO "2"

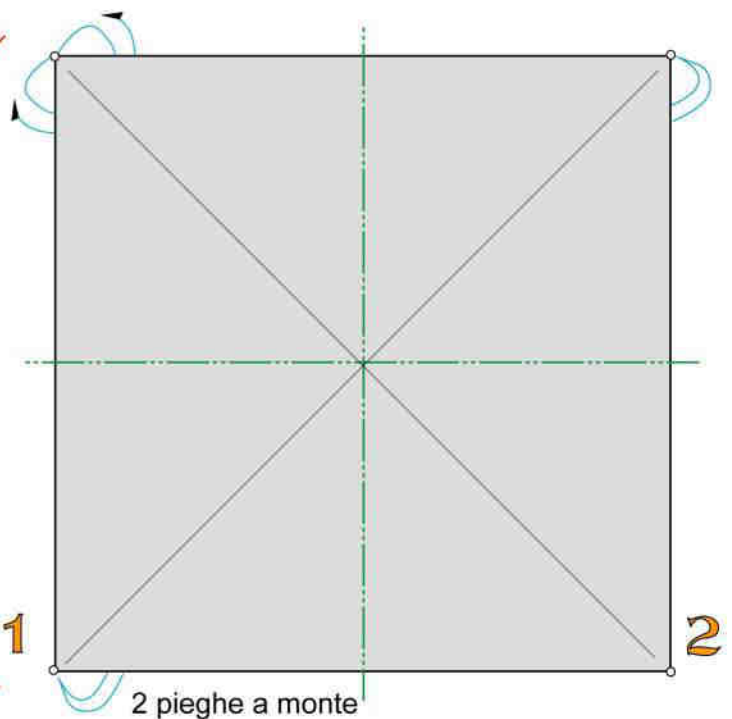
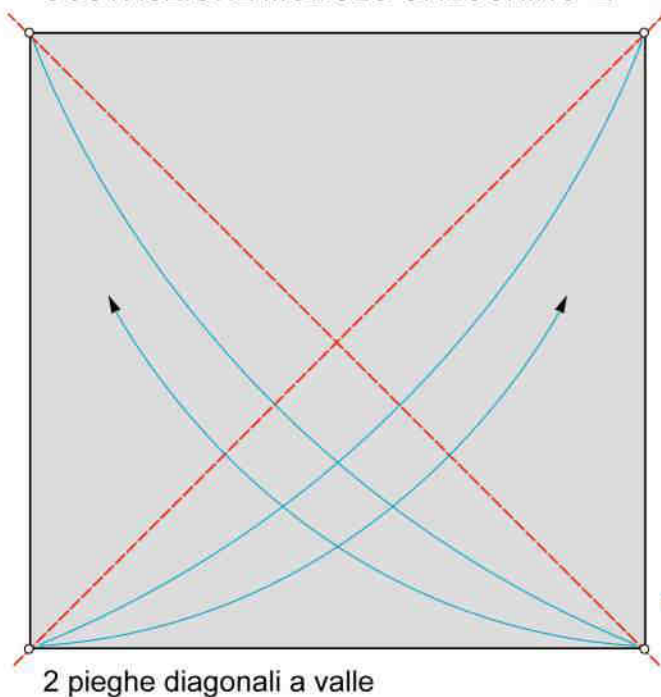

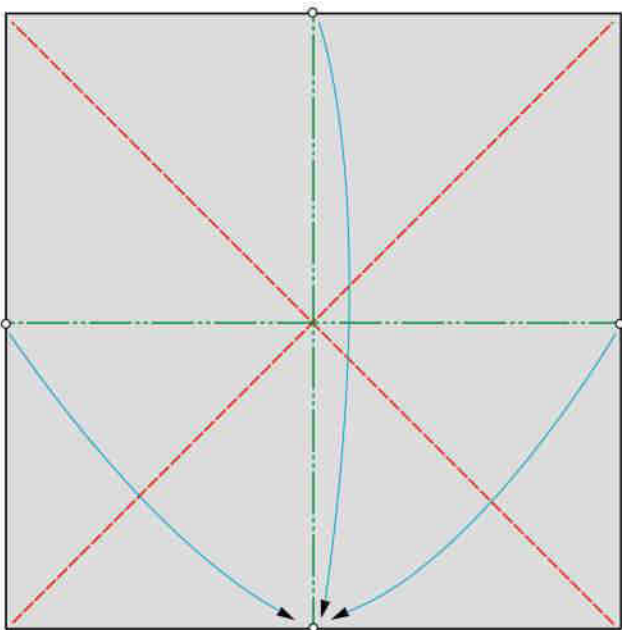

3

Ripiegate a valle e a monte

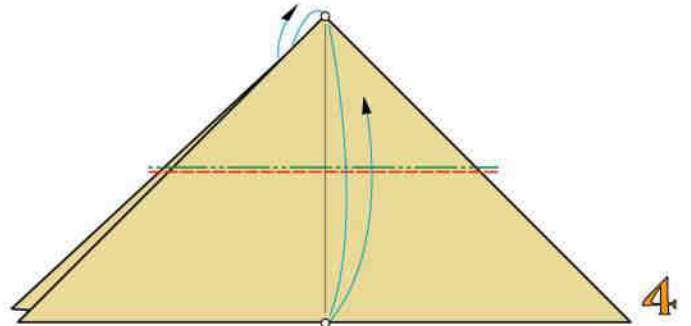

4

1 piega a valle e 1 a monte coincidenti

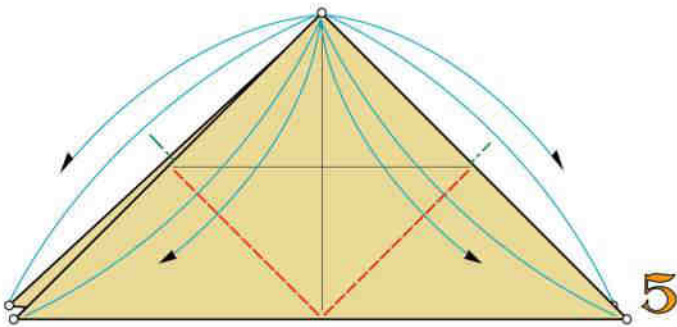

5

4 pieghe a valle, 2 per lato

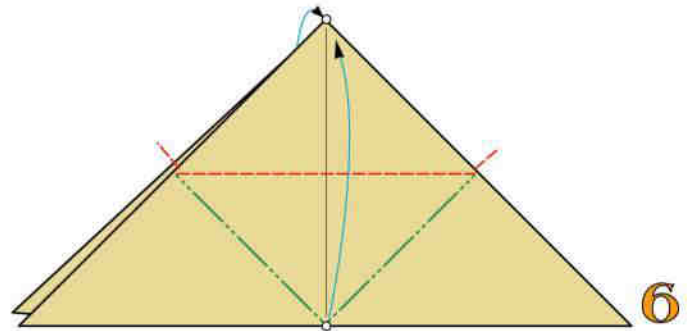

6

Ripiegate a valle e a monte sui 2 lati

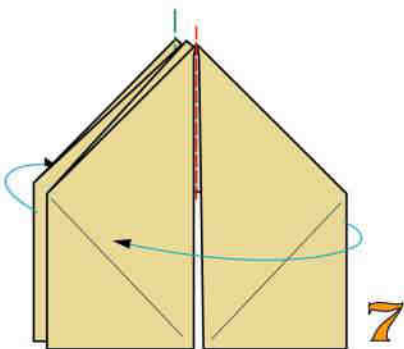

7

Ruotate davanti e dietro

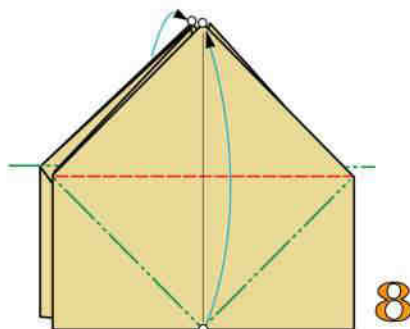

8

Ripiegate a valle e a monte

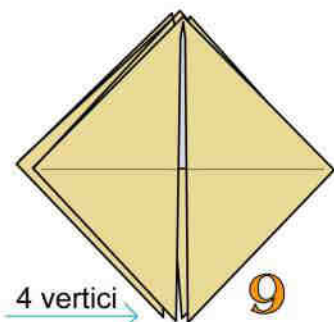

9

4 vertici

Modulo "Orecchino 2" ultimato

COSTRUZIONE MODULO DI BLOCCAGGIO PER "ORECCHINO 2"

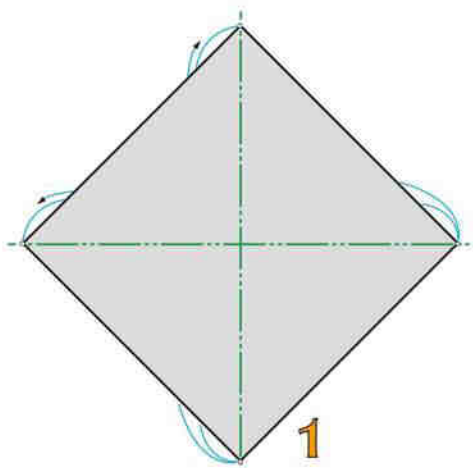

2 pieghe diagonali a monte

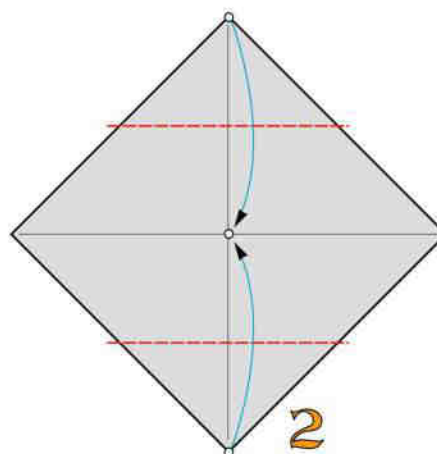

2 pieghe a valle

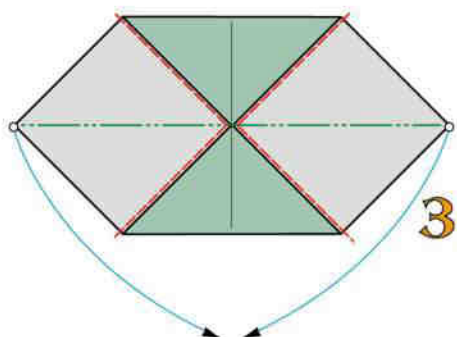

Ripiegate a valle e a monte

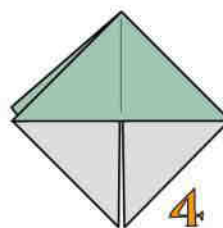

Modulo di bloccaggio per orecchino 2 ultimato

UNIONE DEI MODULI

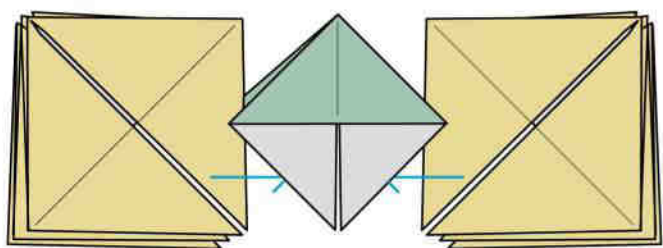

Intascate 2 vertici di 2 moduli per "Orecchino 2" entro 1 modulo di bloccaggio

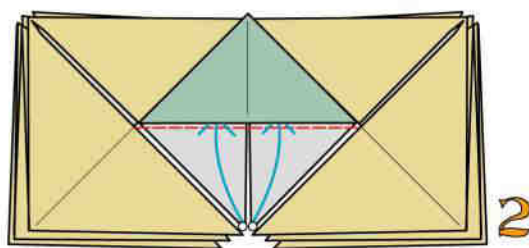

Intascando 2 vertici di 2 moduli per "orecchino 2" entro 1 modulo di bloccaggio, bloccate l'unione

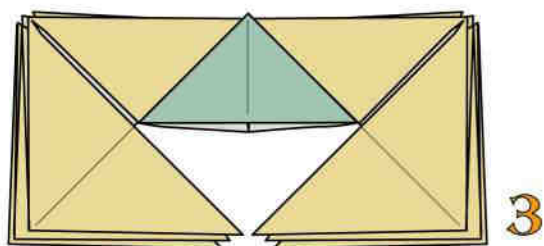

3 moduli uniti

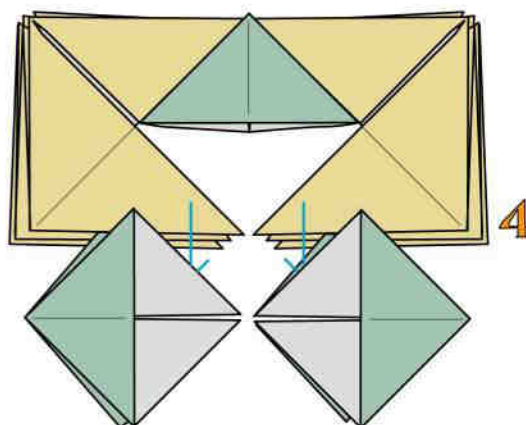

Continuate nello stesso modo

ORECCHINI 3

Franco Pavarin 24

Per ogni orecchino doperate 2 fogli di carta metallizzati delle dimensioni di cm 5x5.
Eseguito il modello, irridite la carta con smalto per unghie o vernice cristallizante.



COSTRUZIONE DEL MODULO SUPERIORE

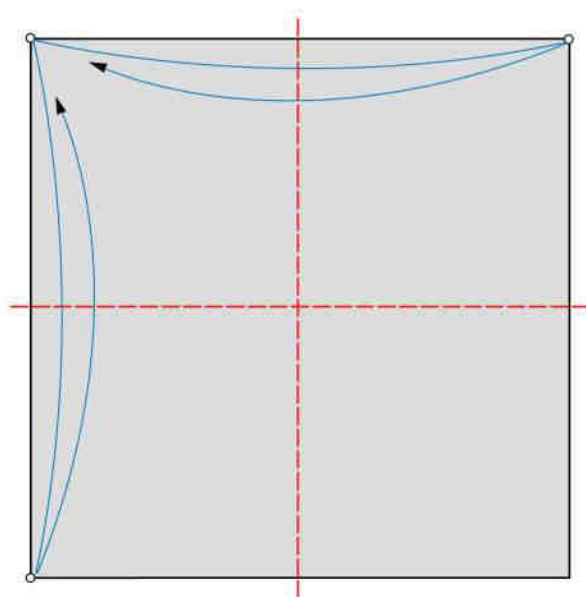

4 pieghe a valle

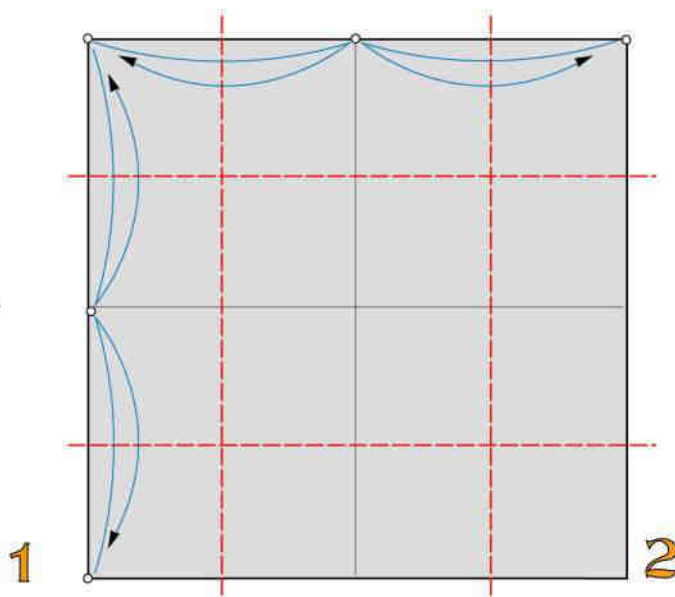

4 pieghe a valle

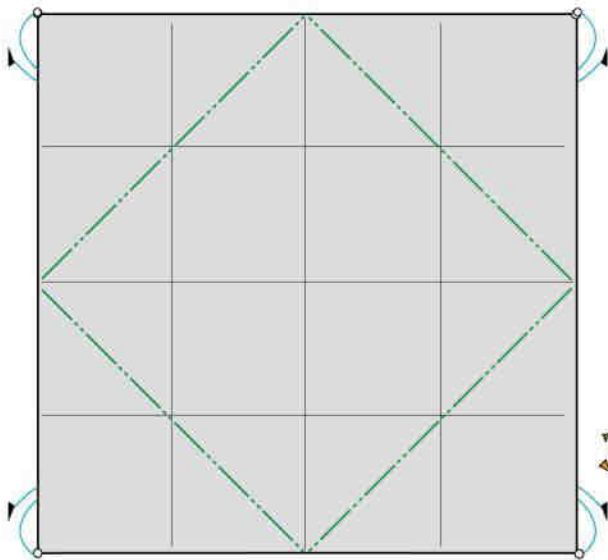

4 pieghe diagonali a valle

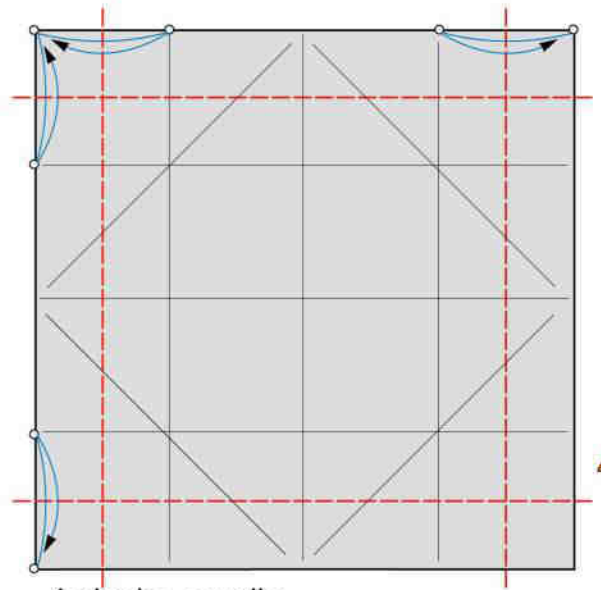

4 pieghe a valle

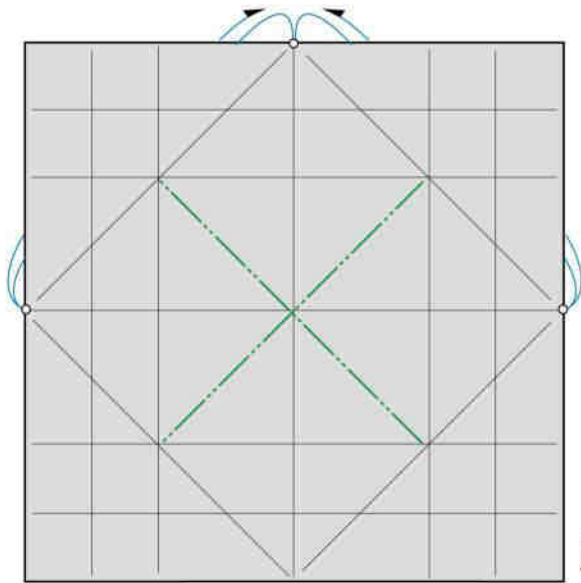

4 pieghe a monte

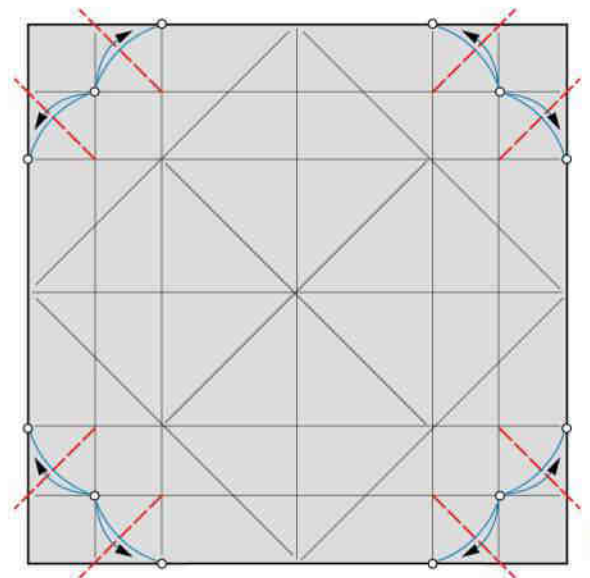

8 pieghe a valle

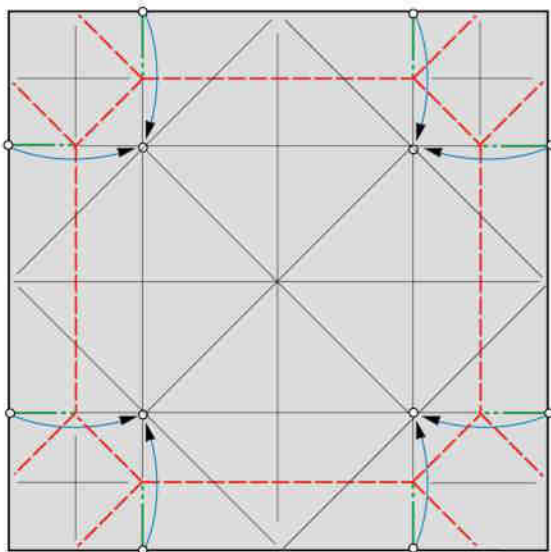

Ripiegate a valle e a monte

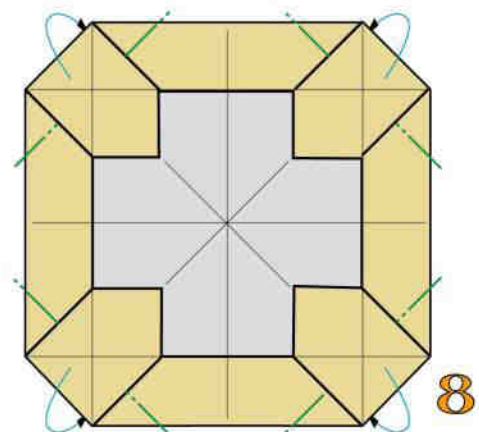

4 pieghe a monte

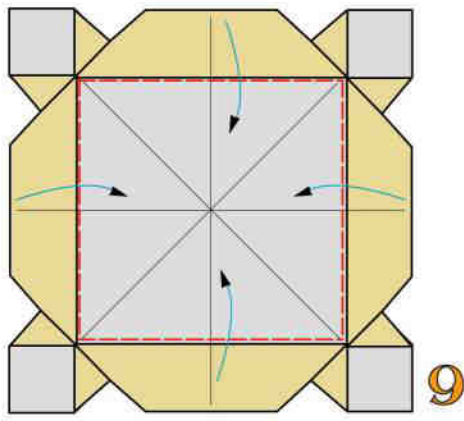

Ripiegate a valle

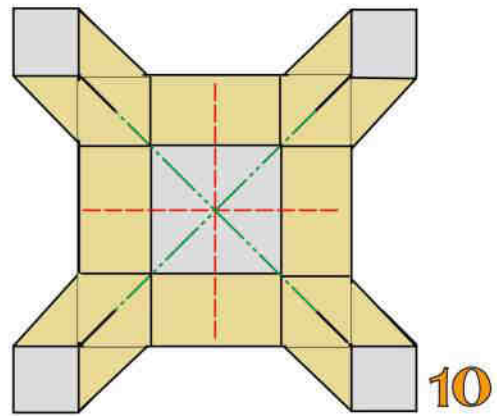

Ripiegate a valle e a monte.
Modulo superiore ultimato

COSTRUZIONE DEL MODULO INFERIORE

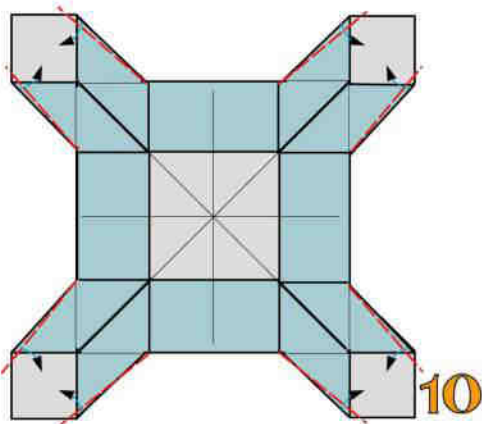

Partite dalla figura n. 10
del modulo superiore.
8 piccole pieghe a valle

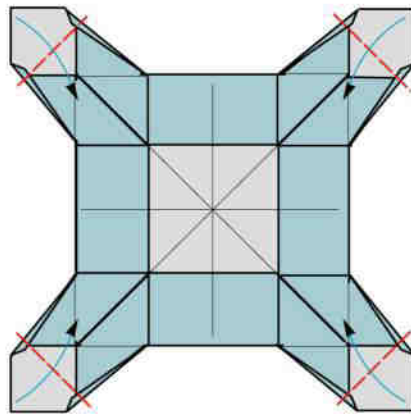

4 pieghe a valle

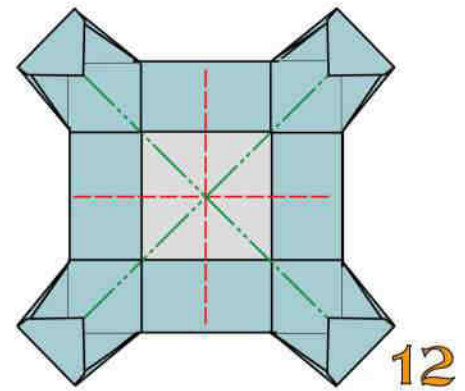

Ripiegate a valle e a monte.
Modulo inferiore ultimato

UNIONE DEI MODULI

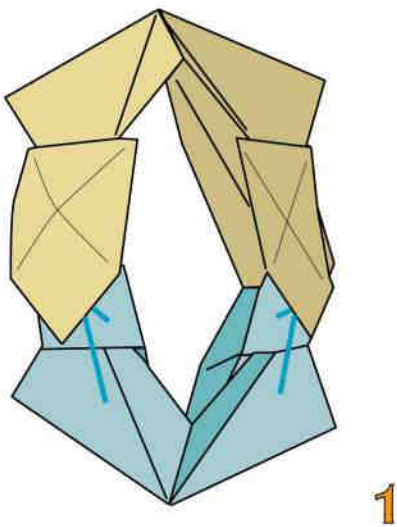

Inserite le estremità del modulo
inferiore entro le estremità del
modulo superiore

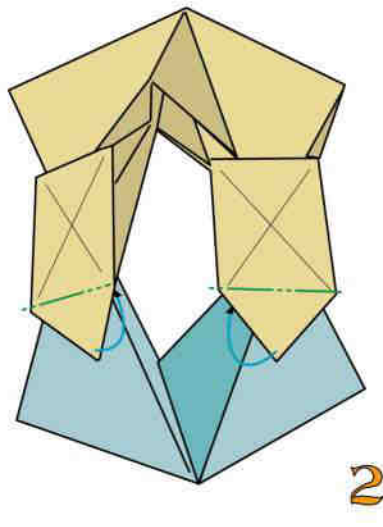

mediante 4 pieghe a
monte bloccate l'unione

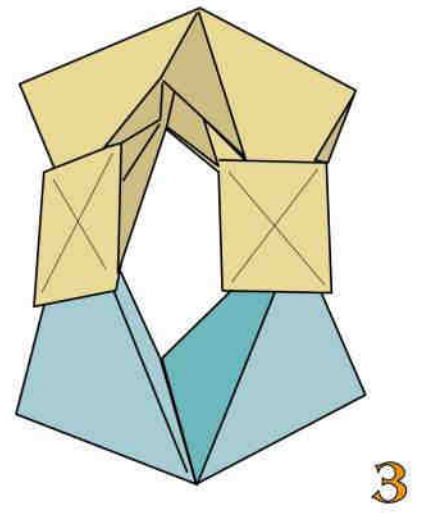

Orecchino ultimato

GHIRLANDA

Franco Pavarin 24

Per costruire questa semplice ghirlanda sono necessari 4 fogli monocolori di carta di medio peso e di dimensioni 10x5 cm

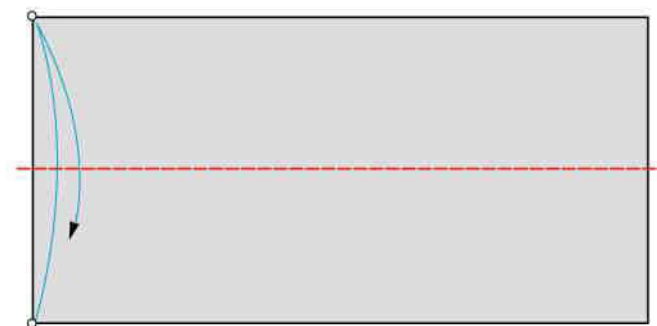
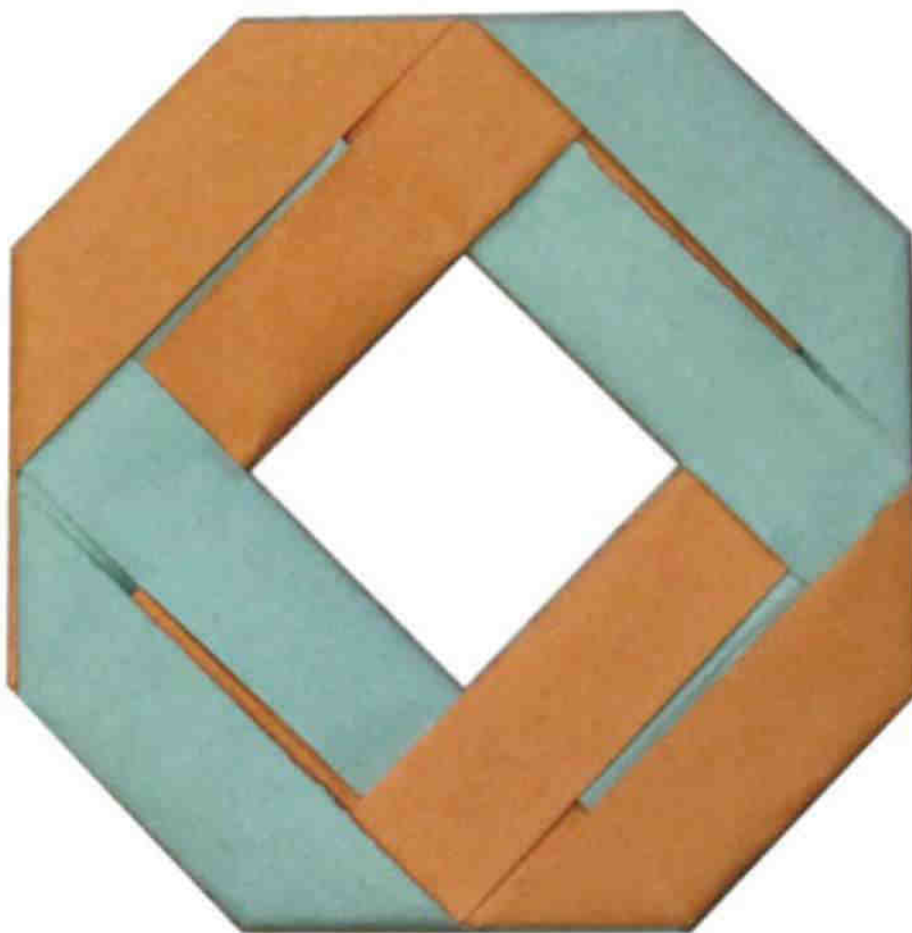

1 piega a valle



2 pieghe a valle

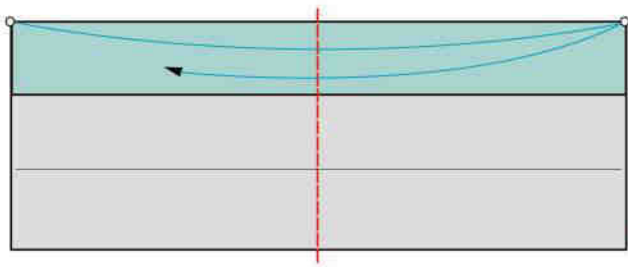

1 piega a valle

3

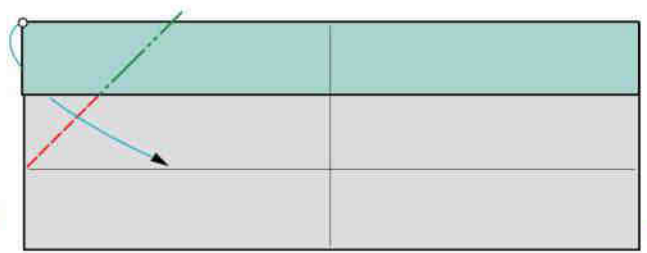

1 piega rovescia interna

4

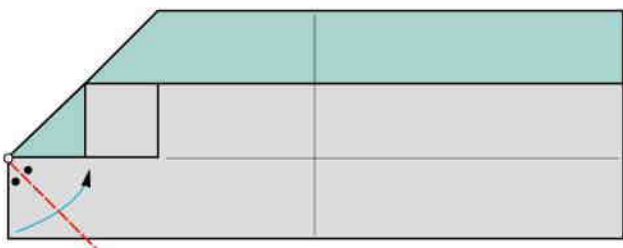

1 piega bisettrice a valle

5



1 piega a monte

6

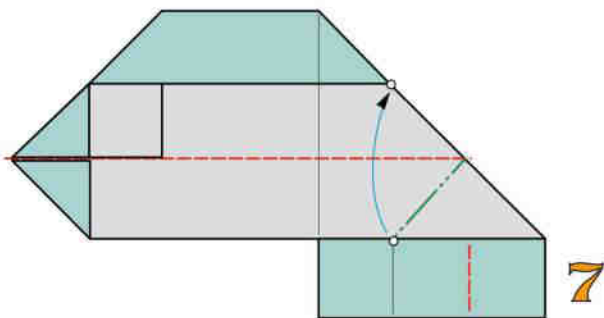

1 piega a monte e ripiegate a valle

7

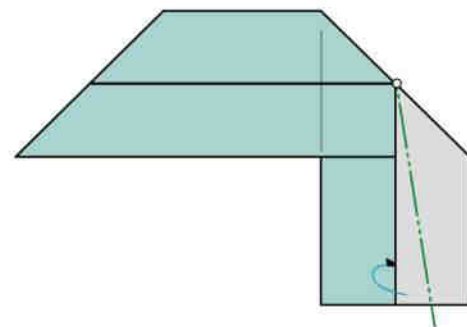

1 piega a monte

8

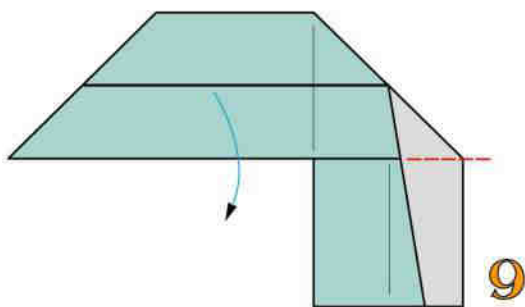

Riaprite

9

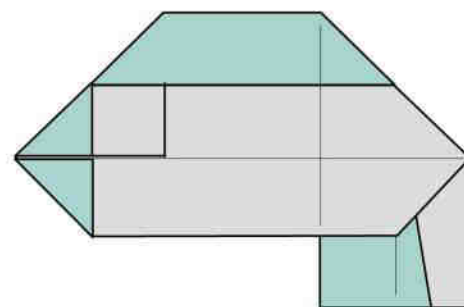

Modulo ghirlanda ultimato

10

UNIONE DEI MODULI

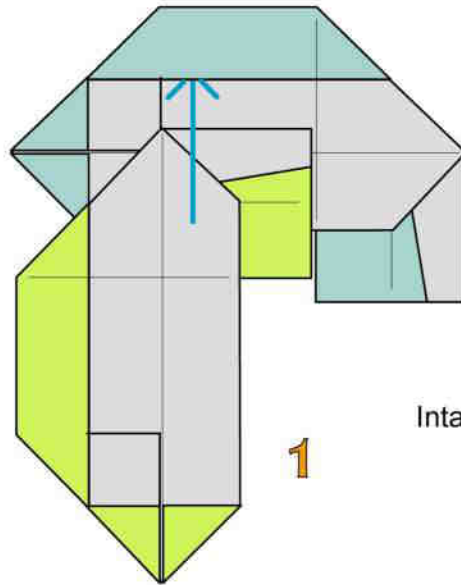

Intascate 1 modulo nell'altro

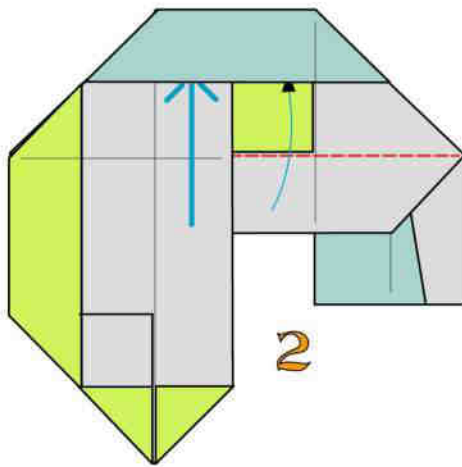

Ripiegando a valle bloccate l'unione

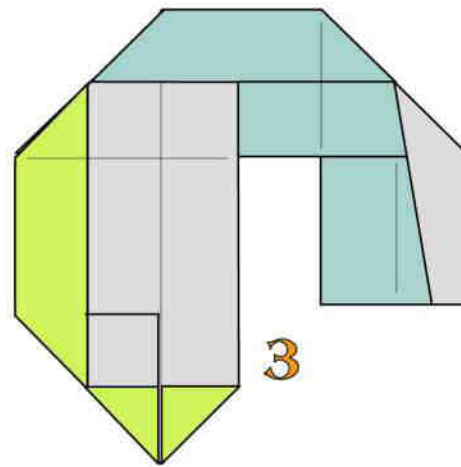

Unione di 2 moduli ghirlanda completata

DECORAZIONE ESAGONALE "A"

Franco Pavarin 24

La decorazione è costituita da 6 moduli composti formati da 1 modulo vertice e 1 modulo di bloccaggio.

Per la costruzione dei moduli adoperate carta monocoloro di medio peso.

Il formato per tutti i moduli è di 10x10 cm.

Costruzione per origamisti esperti.

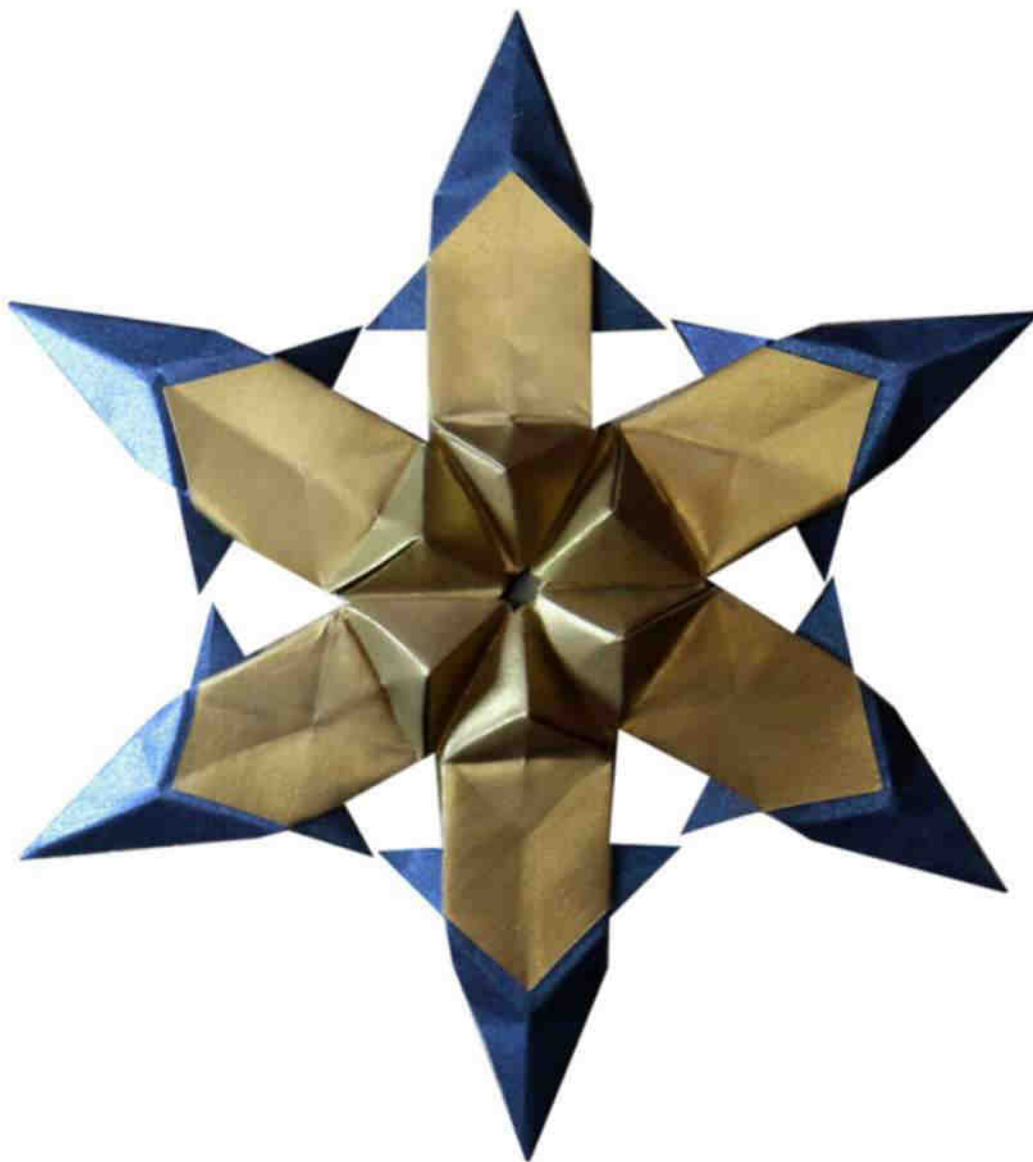

MODULO VERTICE "A"

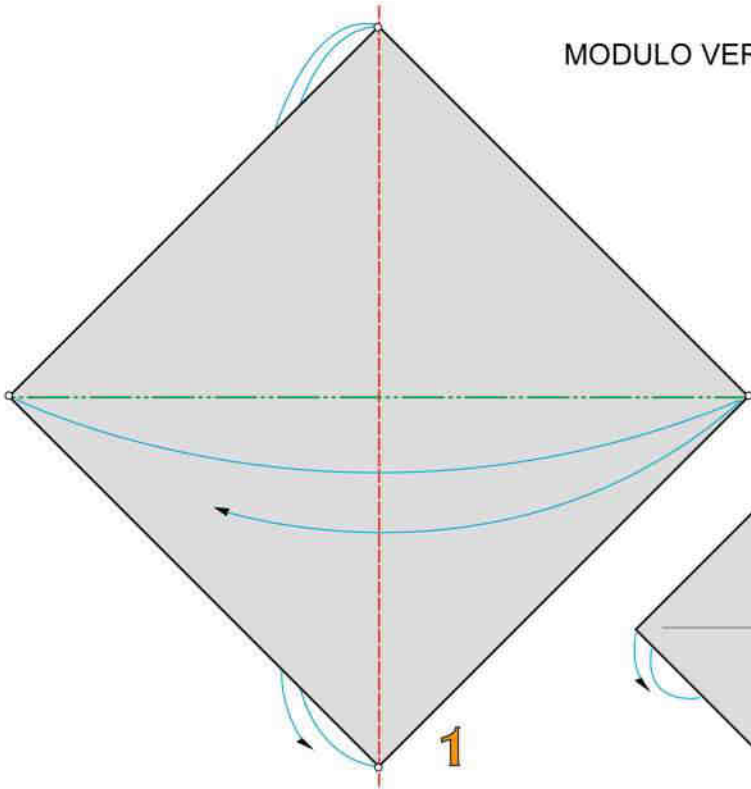

1

1 piega diagonale a valle e 1 a monte

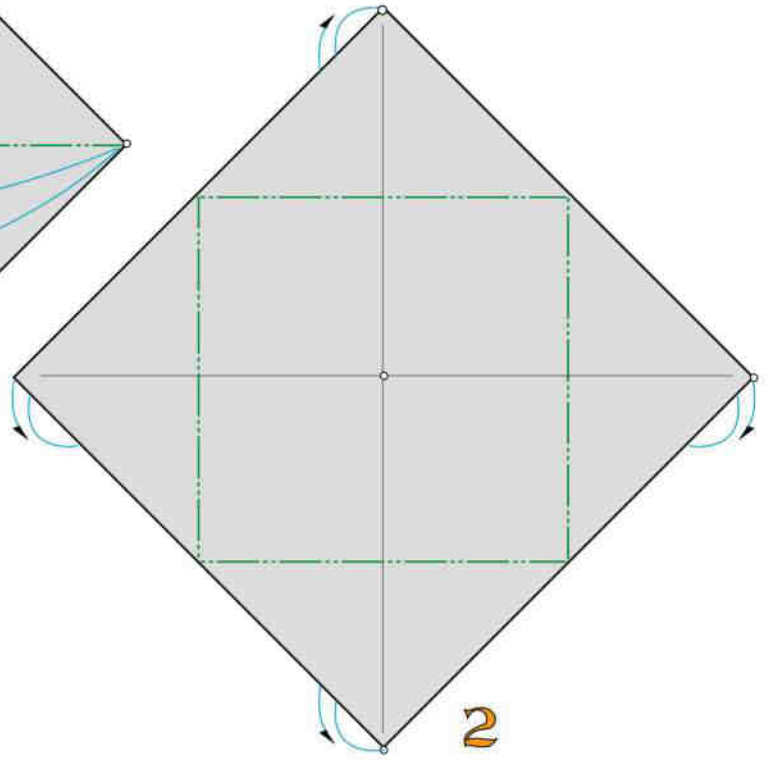

2

4 pieghe a monte

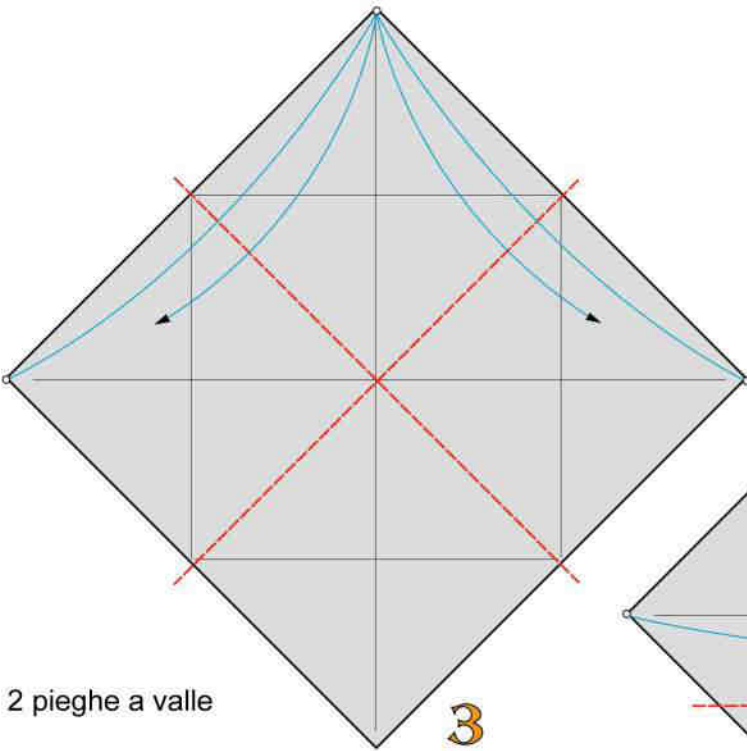

3

2 pieghe a valle

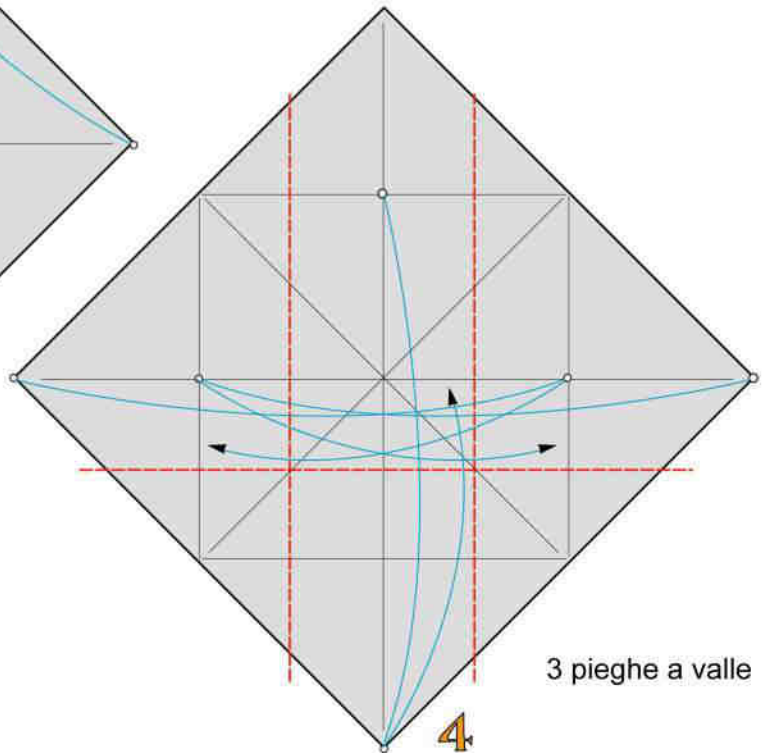

4

3 pieghe a valle

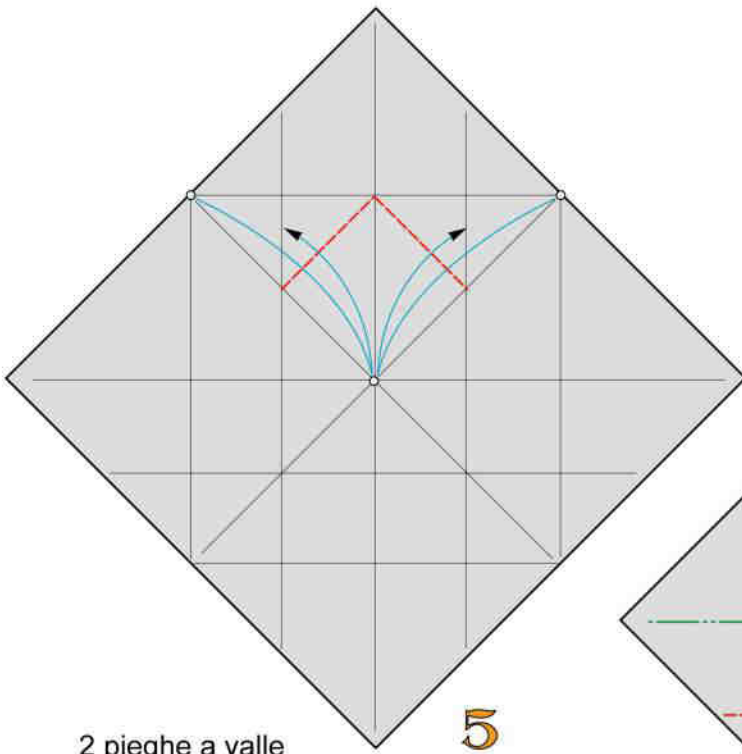

2 pieghe a valle

5

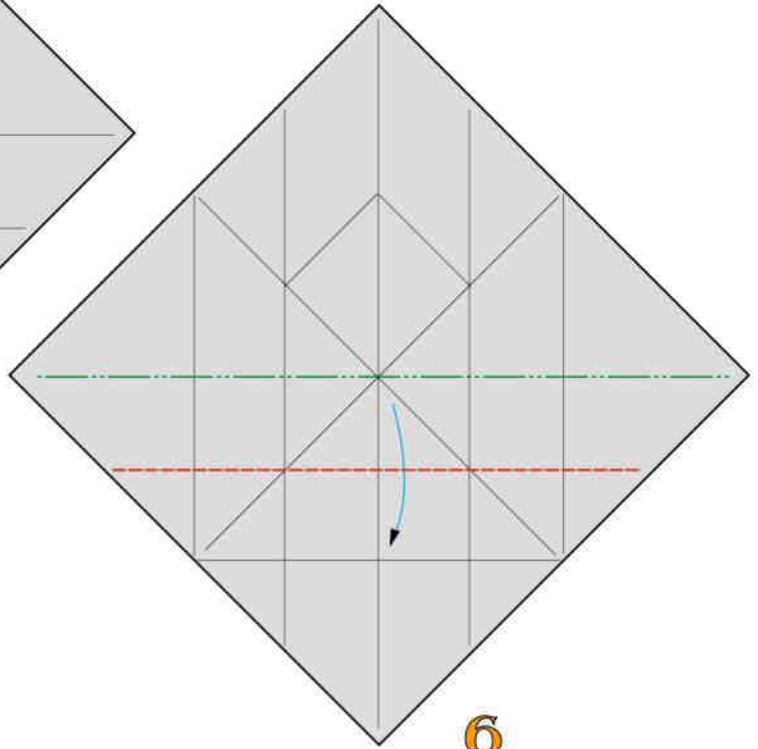

6

Ripiegate a valle e a monte

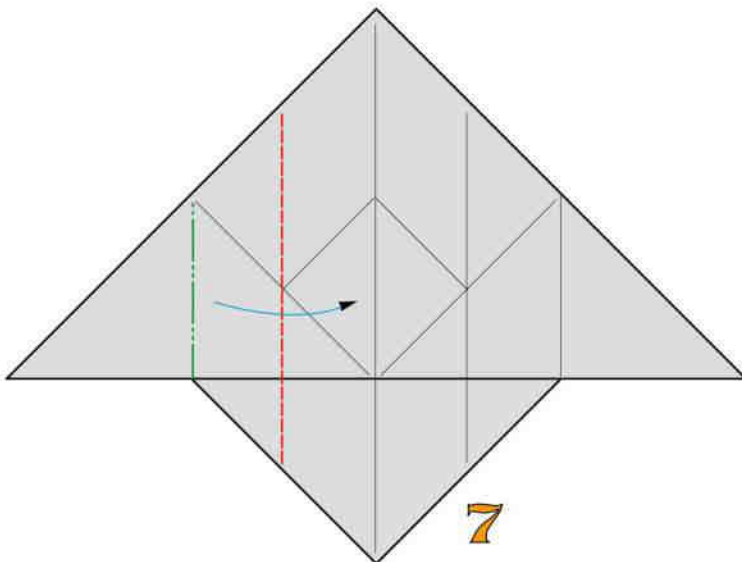

7

Ripiegate a valle e a monte

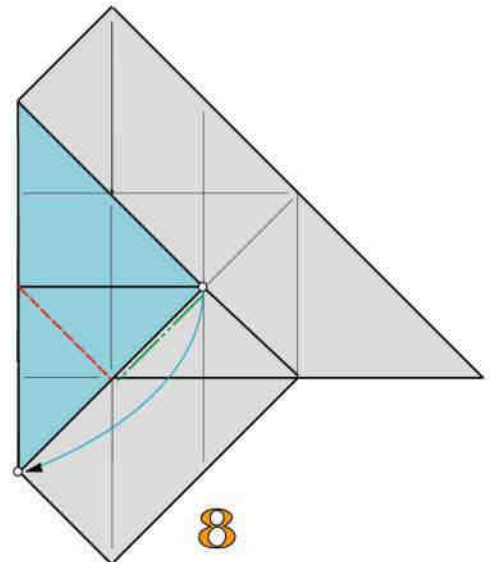

8

1 piega a valle e ripiegate a monte

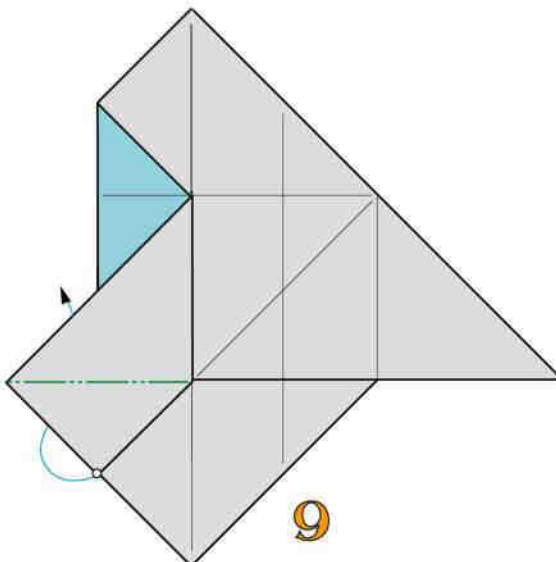

9

1 piega rovescia interna

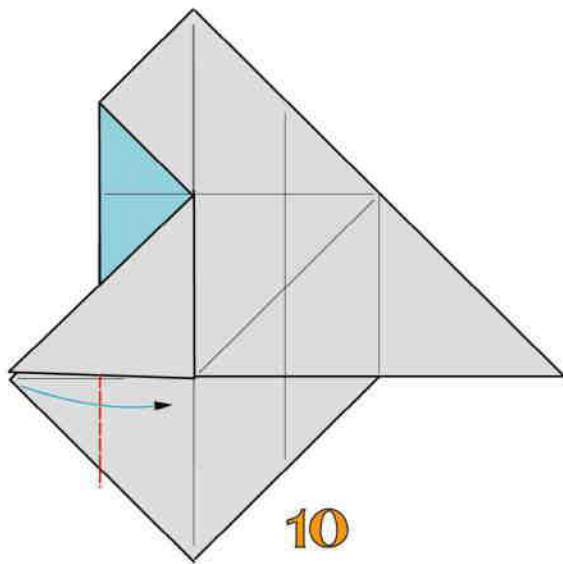

10

1 piega a valle

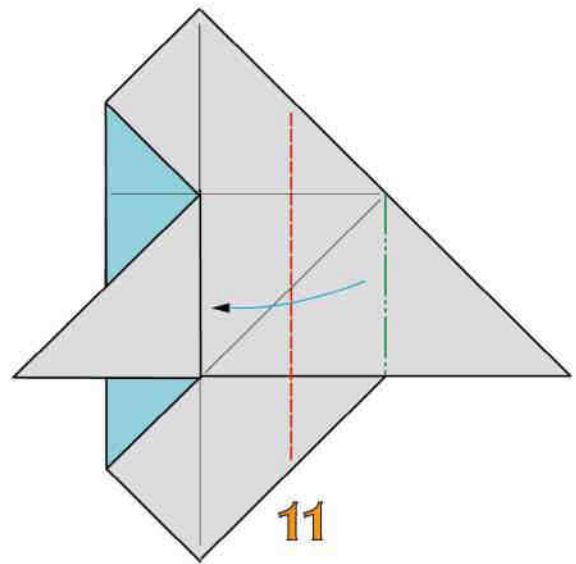

11

Ripiegate a valle e a monte

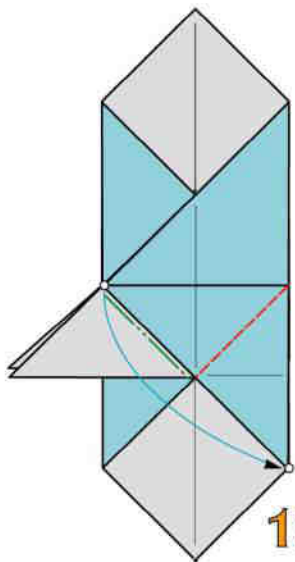

12

1 piega a valle e ripiegate a monte

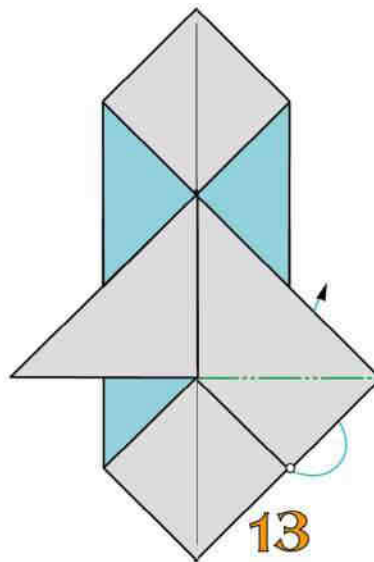

13

1 piega rovescia interna

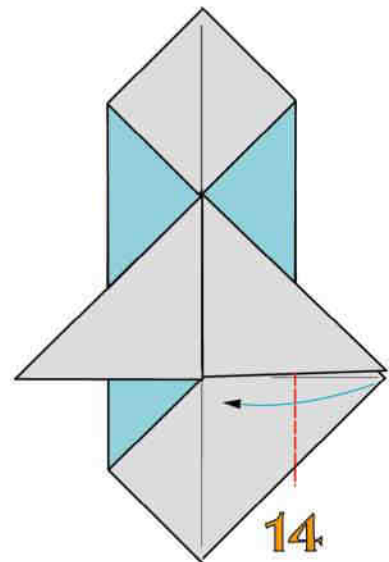

14

1 piega a valle

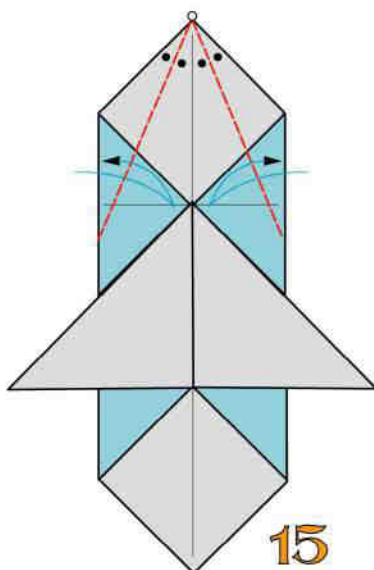

15

2 pieghe bisettrici a valle

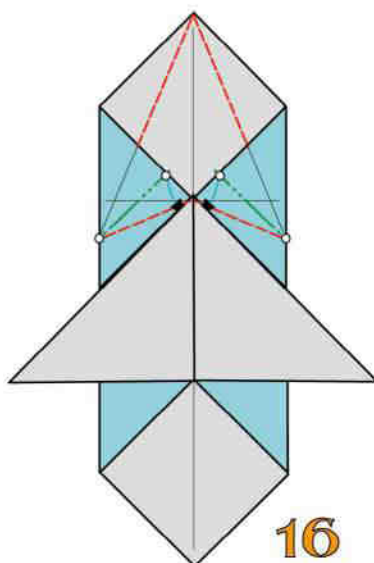

16

2 pieghe a monte e ripiegate a valle

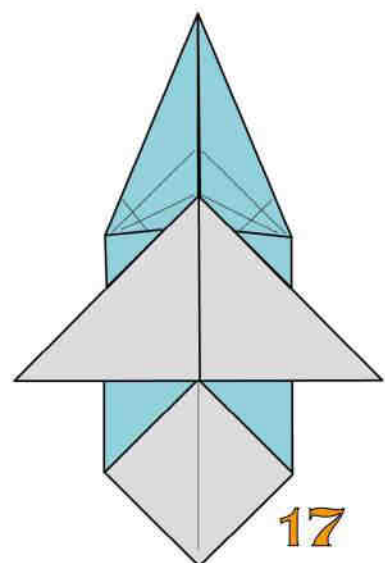

17

Modulo vertice "A" ultimato

MODULO DI BLOCCAGGIO "A"

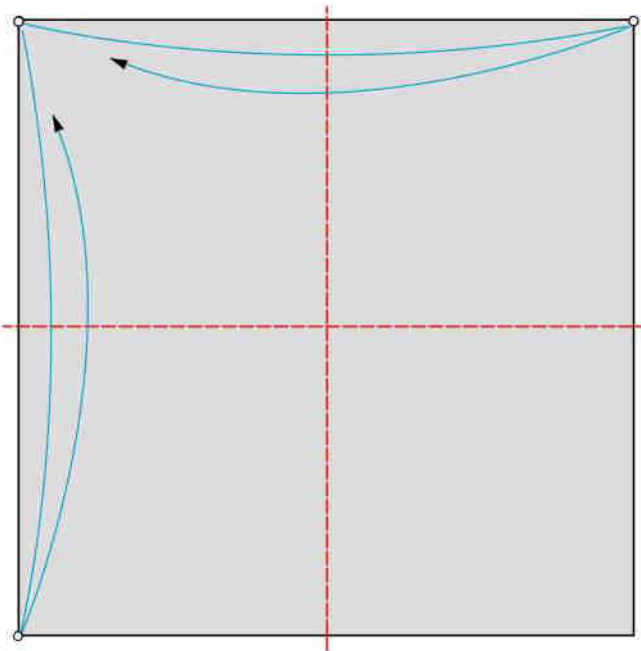

2 pieghe a valle

1

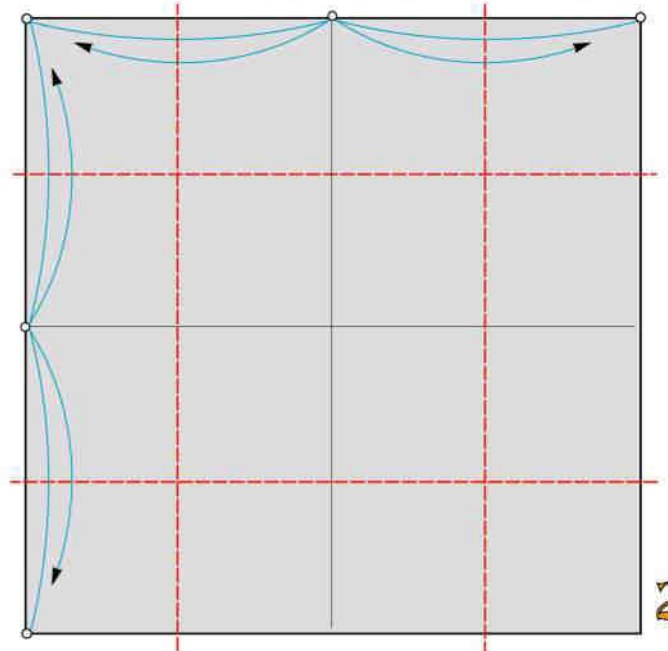

4 pieghe a valle

2

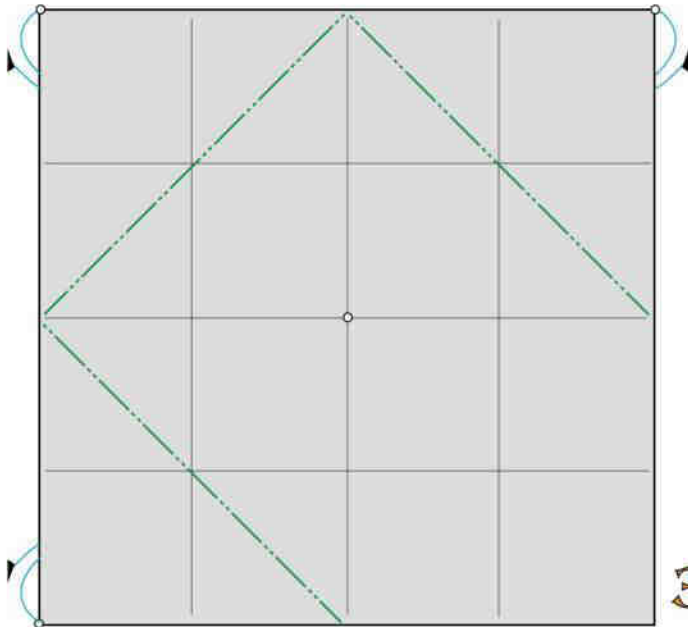

3 pieghe diagonali a monte

3

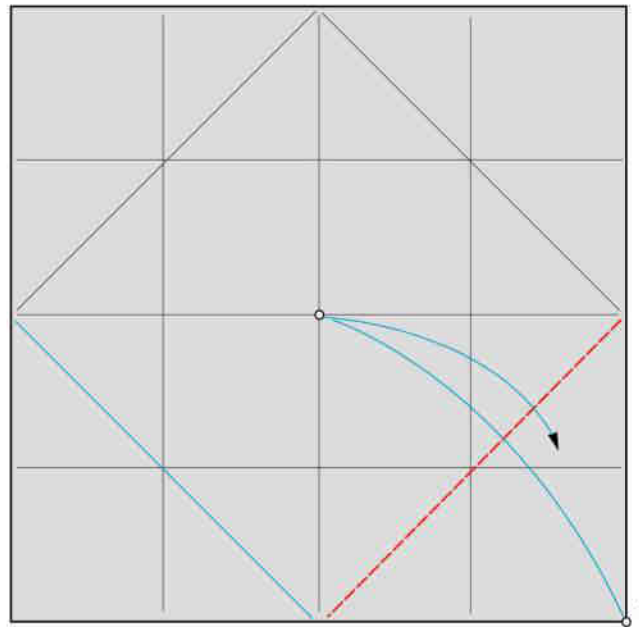

1 piega diagonale a valle

4

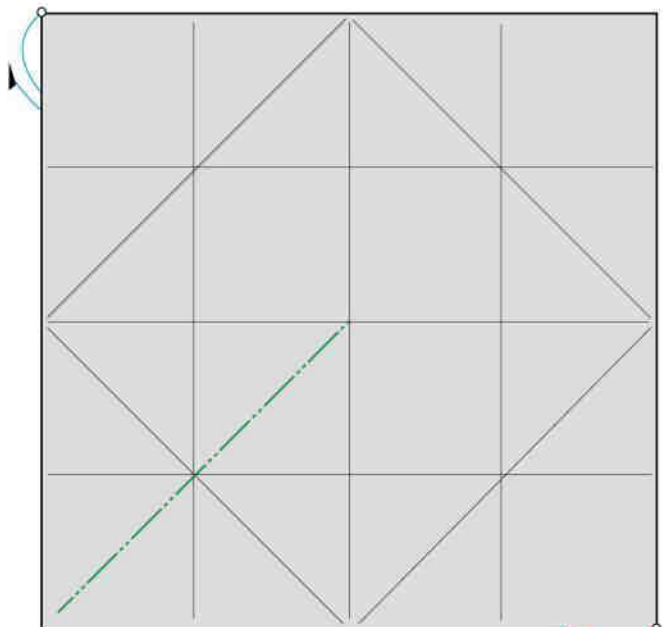

1 piega diagonale a monte

5

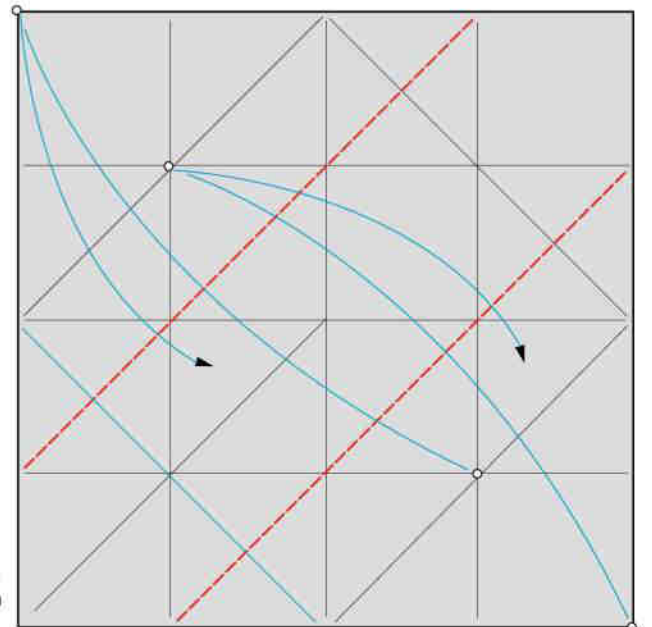

2 pieghe a valle

6

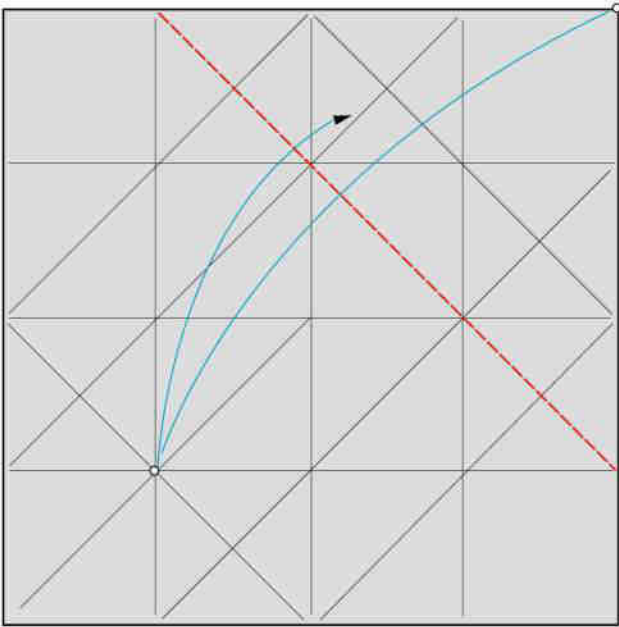

7

1 piega a valle

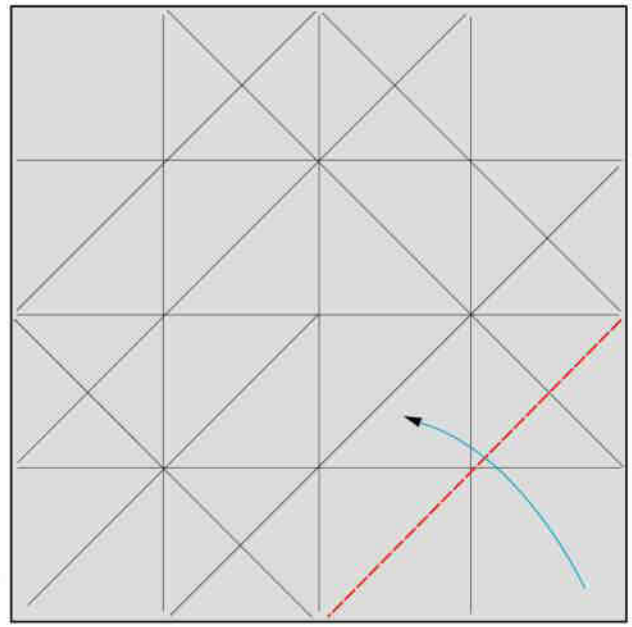

8

Ripiegate a valle

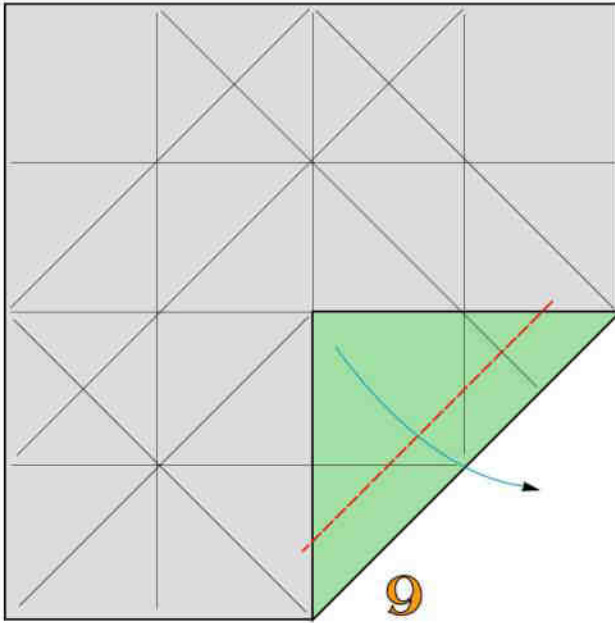

9

1 piega a valle

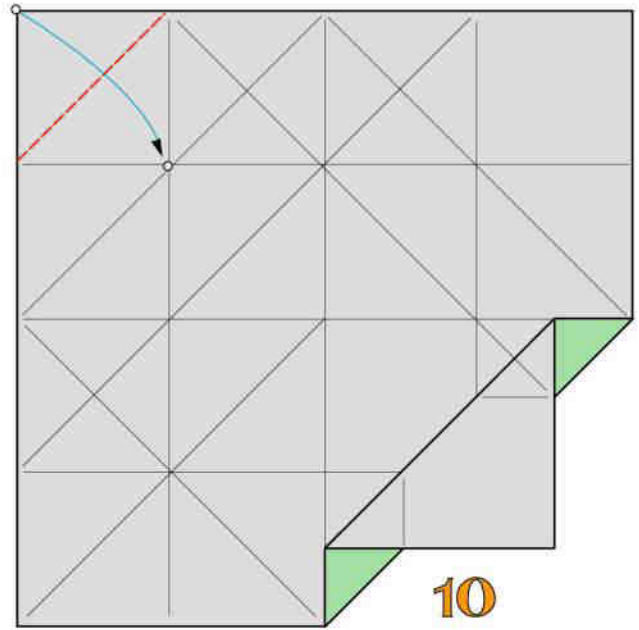

10

1 piega a valle

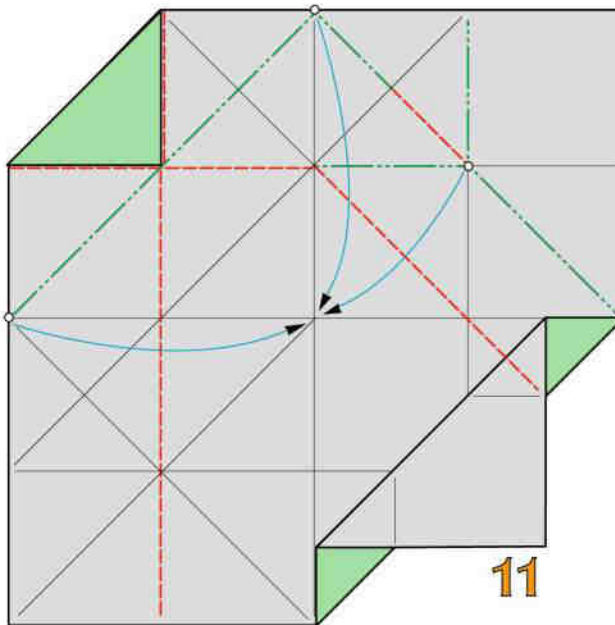

11

Ripiegate a valle e a monte

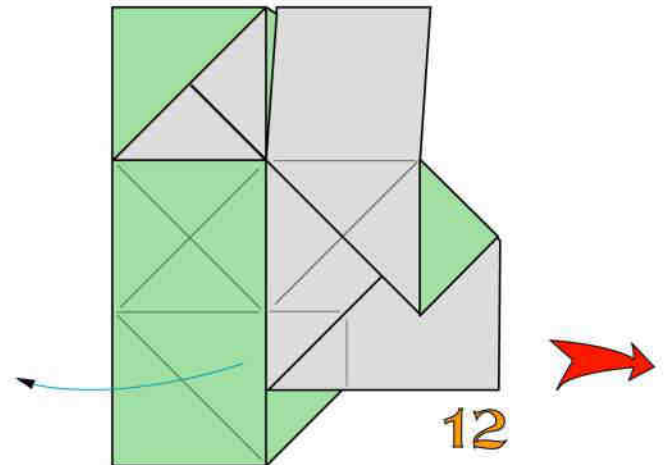

12

Aprite

FORMAZIONE DEI MODULI COMPOSTI

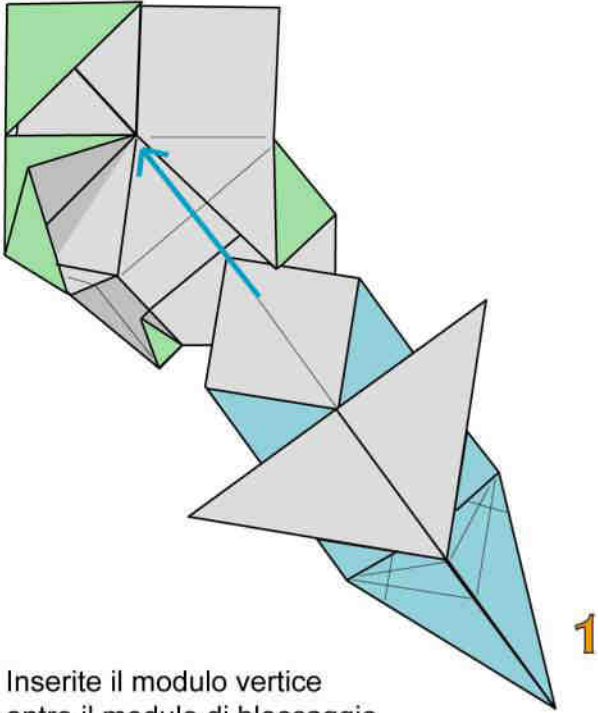

Inserite il modulo vertice
entro il modulo di bloccaggio

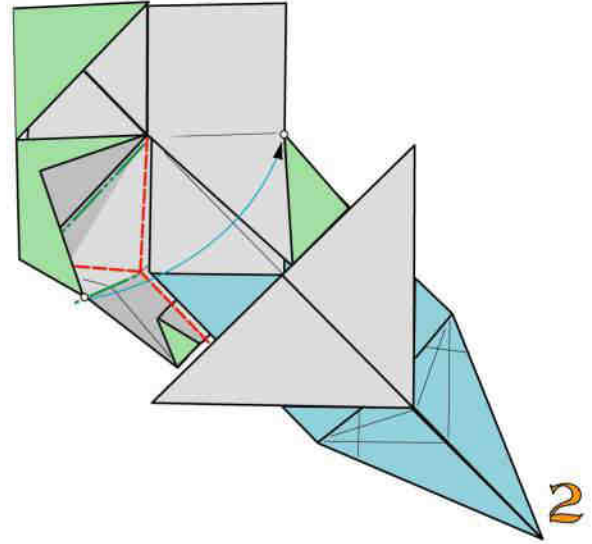

Chiudete ripiegando a valle e a monte

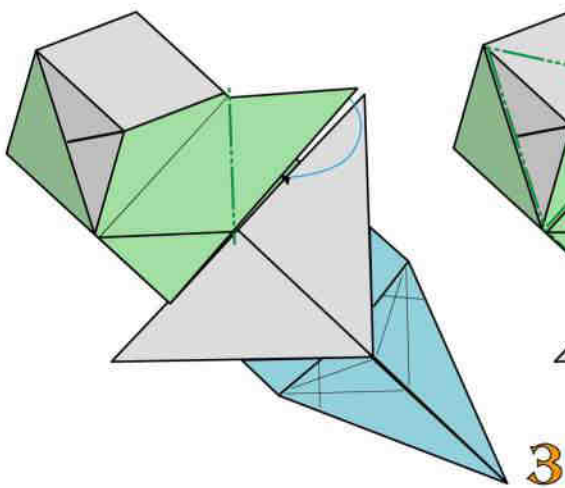

Con 1 piega a monte
intascando bloccate l'unione

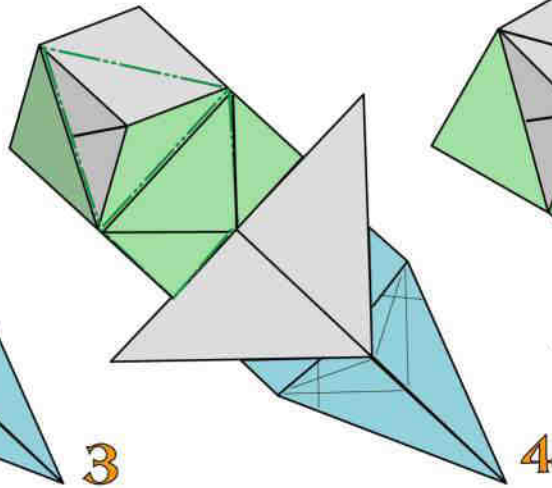

Ripiegate 3 volte a monte

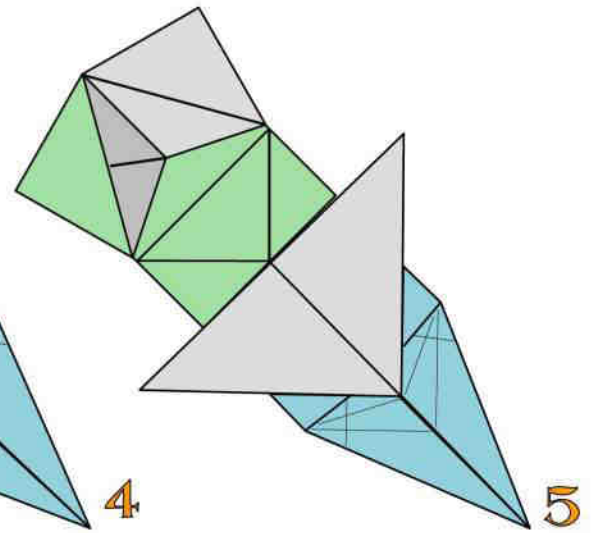

Modulo composto ultimato

UNIONE DEI MODULI COMPOSTI

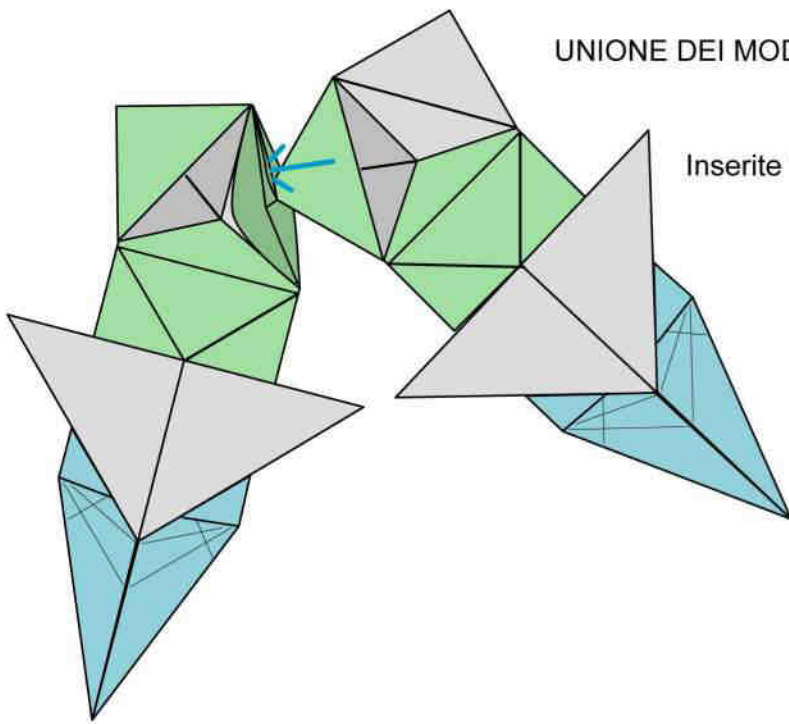

Inserite 1 vertice di un modulo nell'altro

Ripiegando a monte intascate e bloccate l'unione

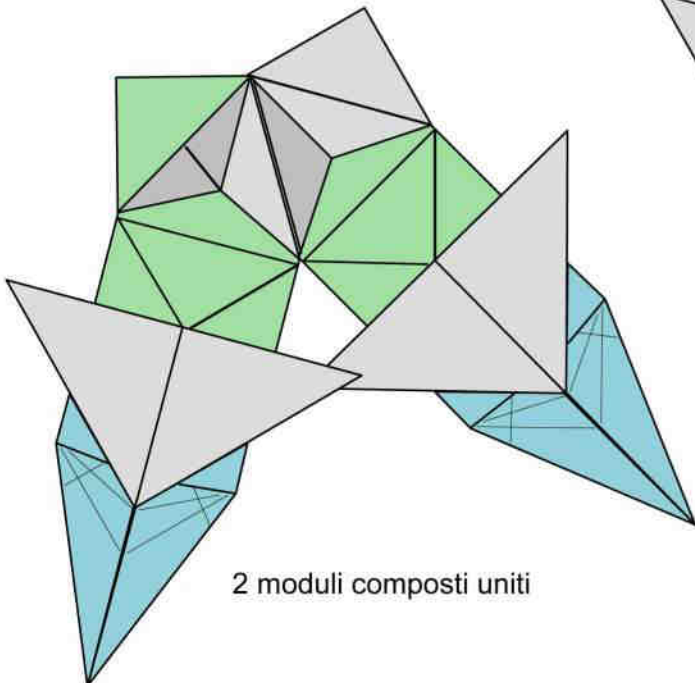
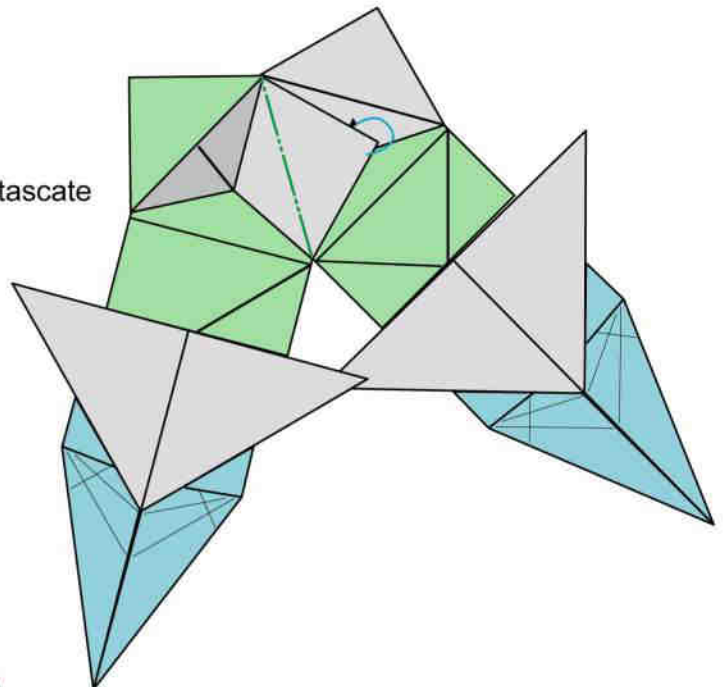

2 moduli composti uniti

DECORAZIONE ESAGONALE "B"

Franco Pavarin 24

La decorazione è costituita da 6 moduli composti formati da 1 modulo vertice e 1 modulo di bloccaggio.

Per la costruzione del modulo vertice adoperate carta monocolore di medio peso mentre per quello di bloccaggio carta bicolore o monocolore.

Il formato per tutti i moduli è di 10x10 cm.

Per piegatori esperti.

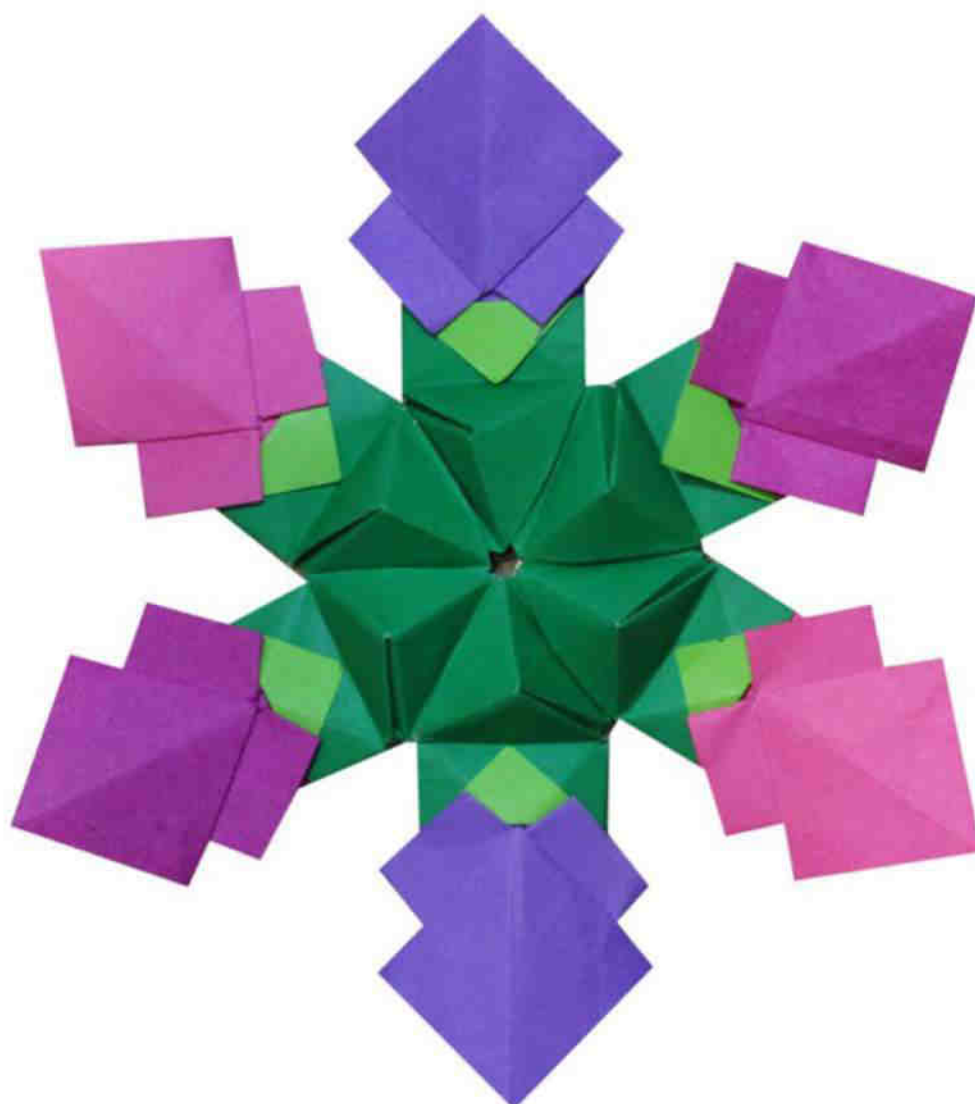

MODULO VERTICE

1 piega diagonale a valle e 1 a monte

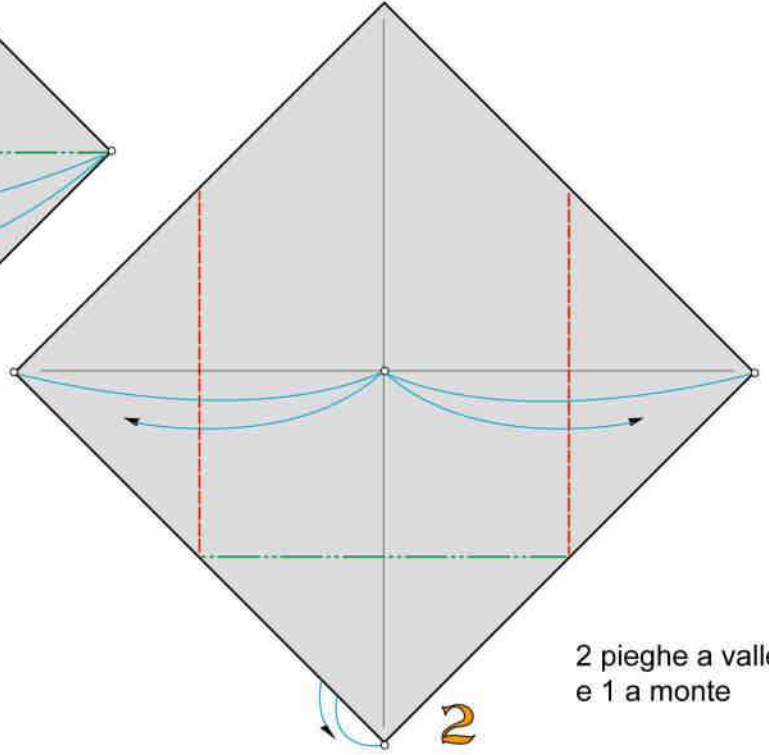
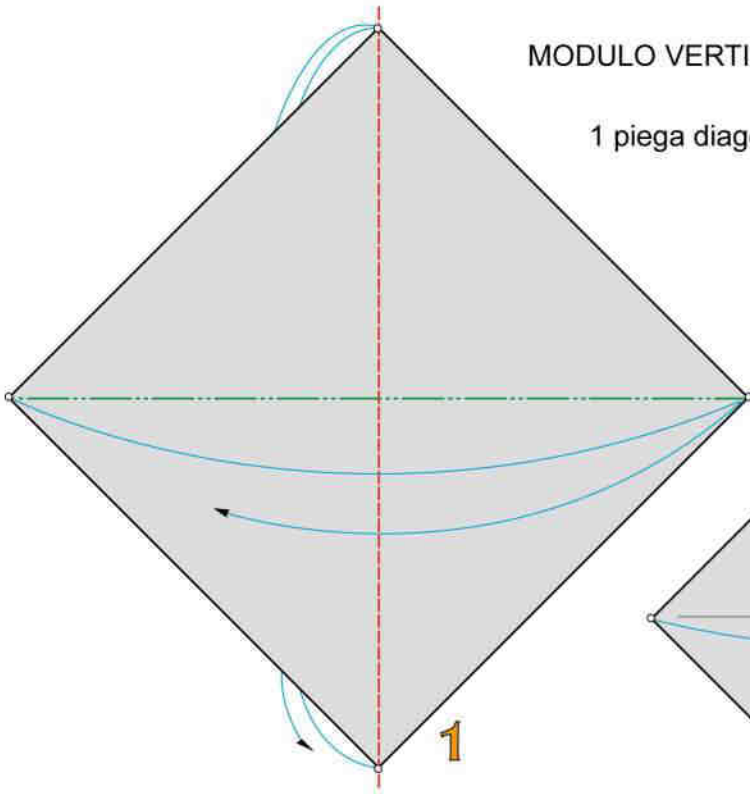

2 pieghe a valle e 1 a monte

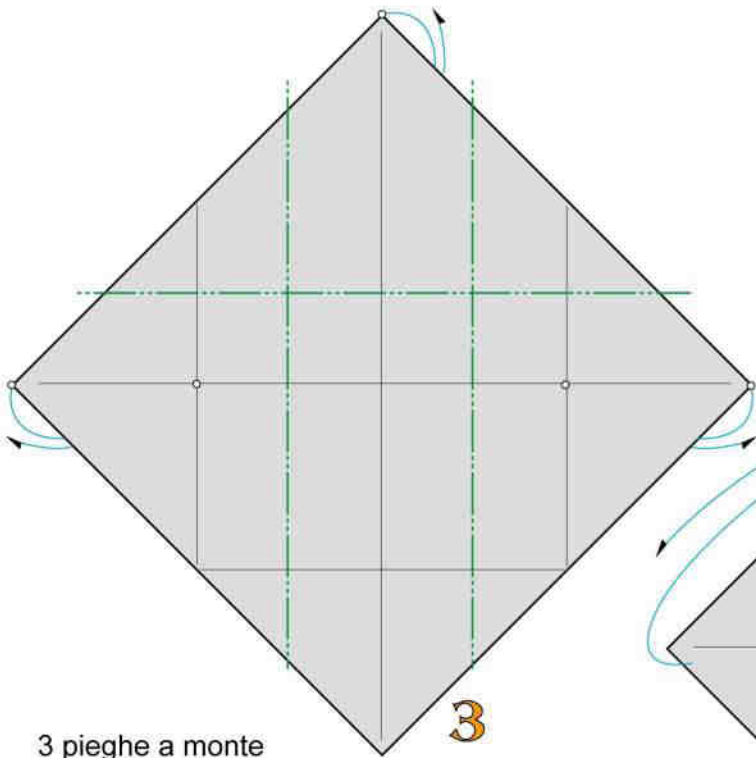

3 pieghe a monte

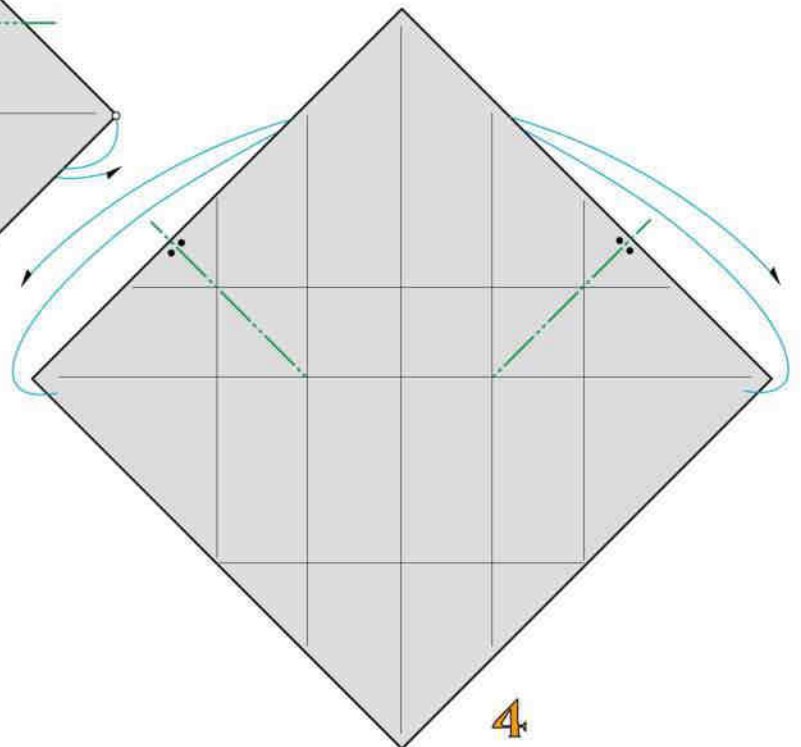

2 pieghe bisettrici a monte

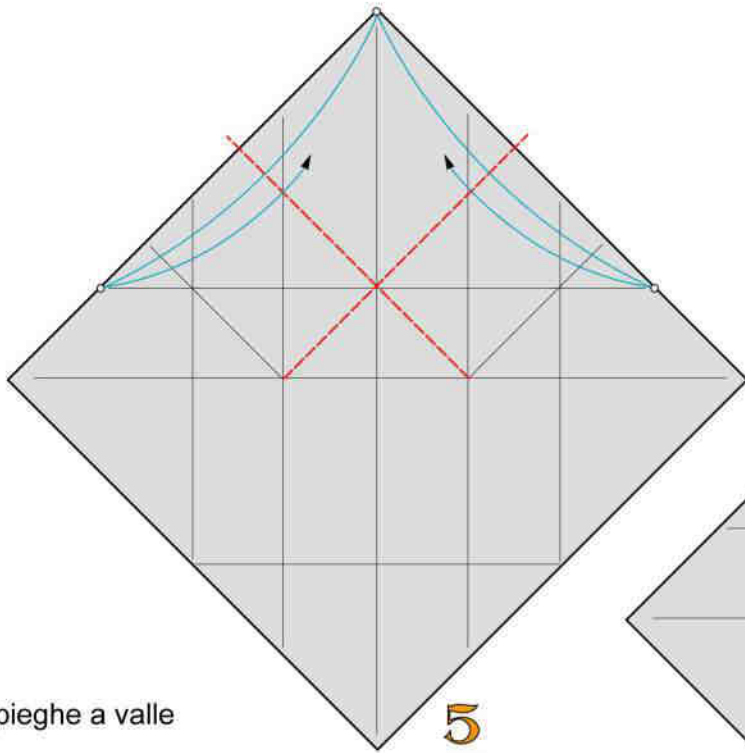

2 pieghe a valle

5

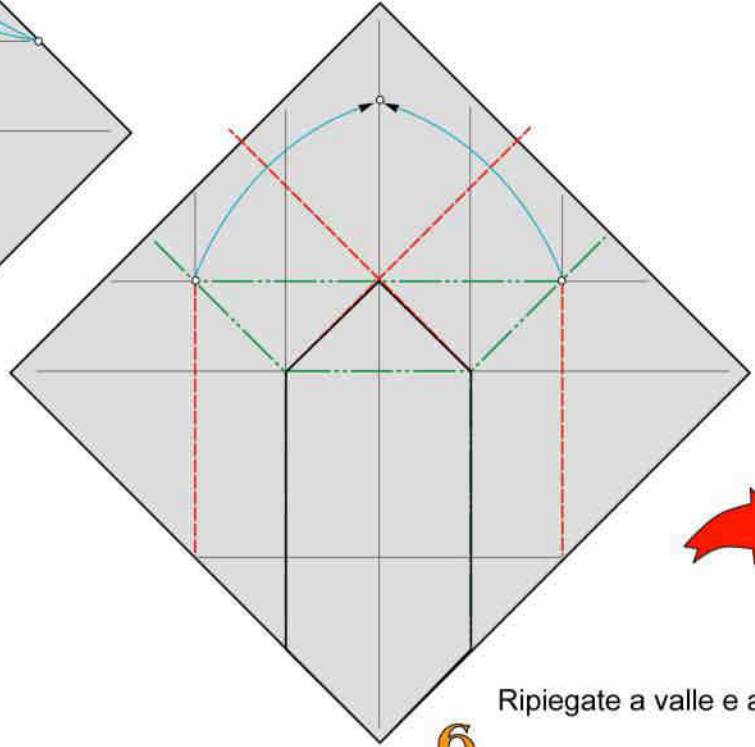

Ripiegate a valle e a monte

6

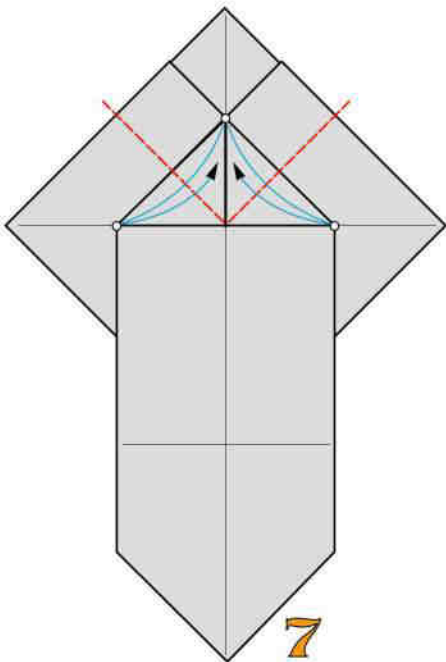

2 pieghe a valle

7

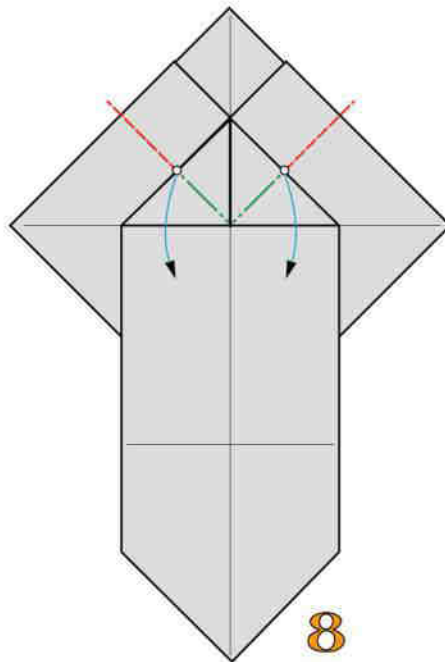

Ripiegate a valle e a monte

8

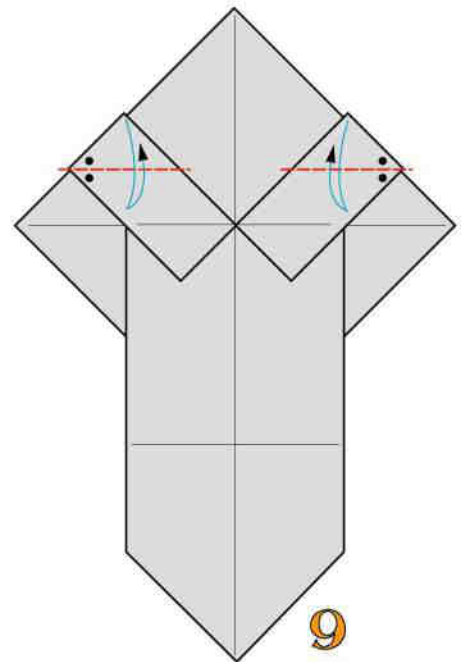

2 pieghe bisettrici a valle

9

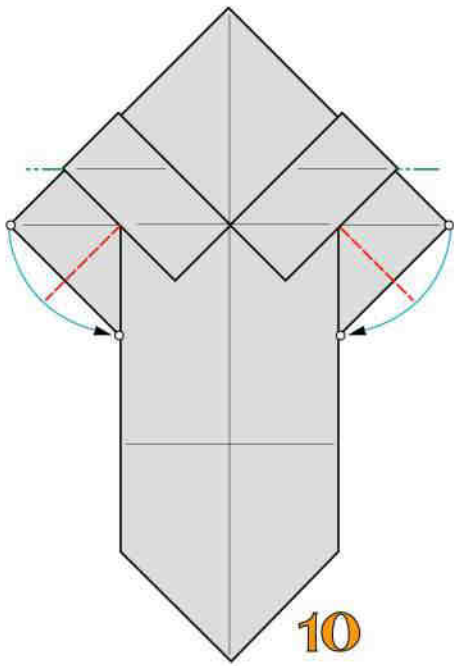

10

2 pieghe a valle

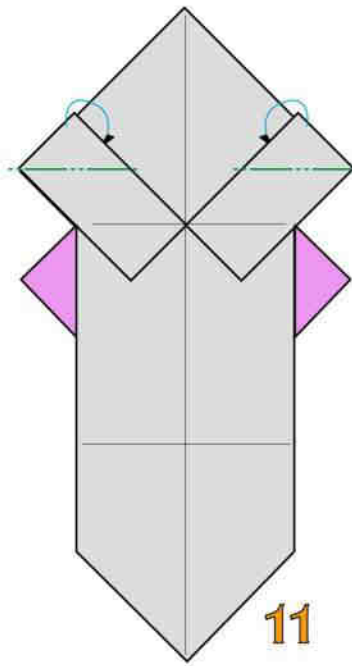

11

2 pieghe a monte

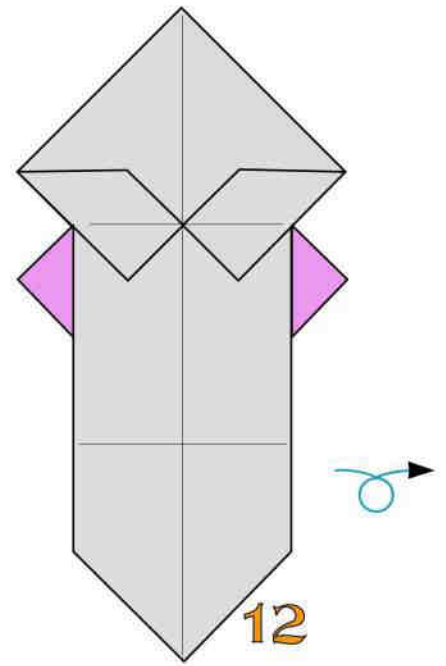

12

Ribaltate

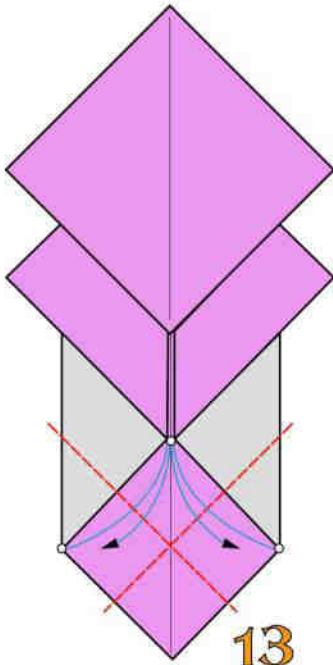

13

2 pieghe a valle

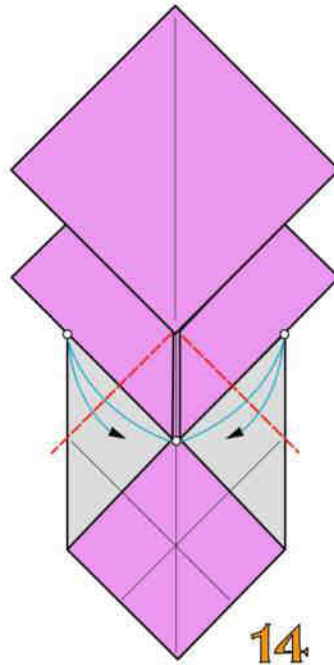

14

2 pieghe a valle

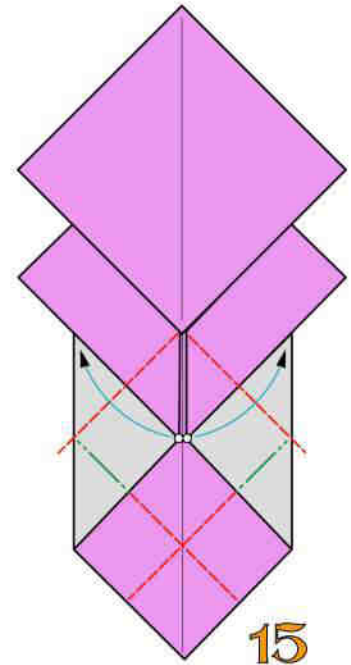

15

Ripiegate a valle e a monte

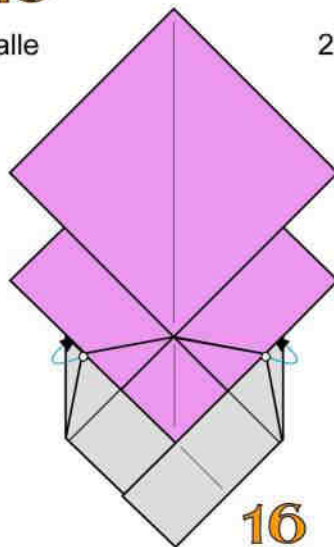

16

Inserite inferiormente i 2 vertici

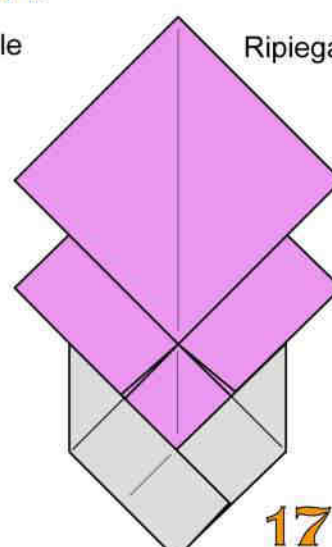

17

Modulo di verice ultimato

MODULO DI BLOCCAGGIO

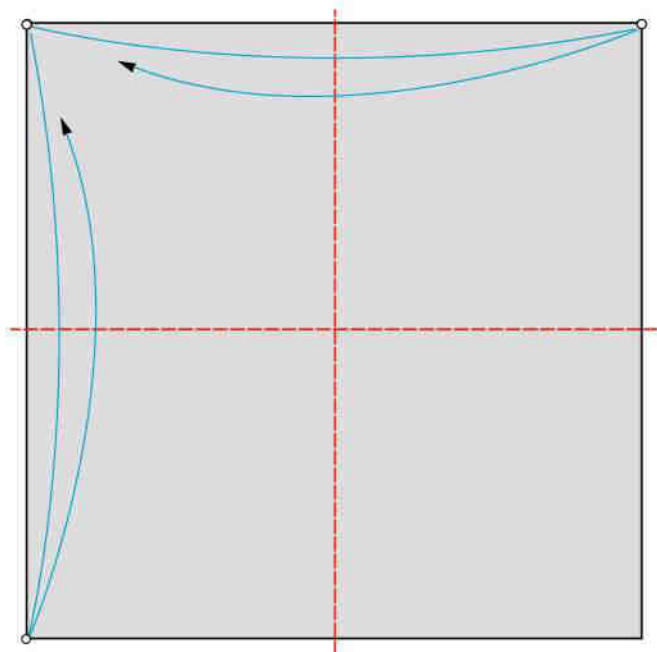

1

2 pieghe a valle

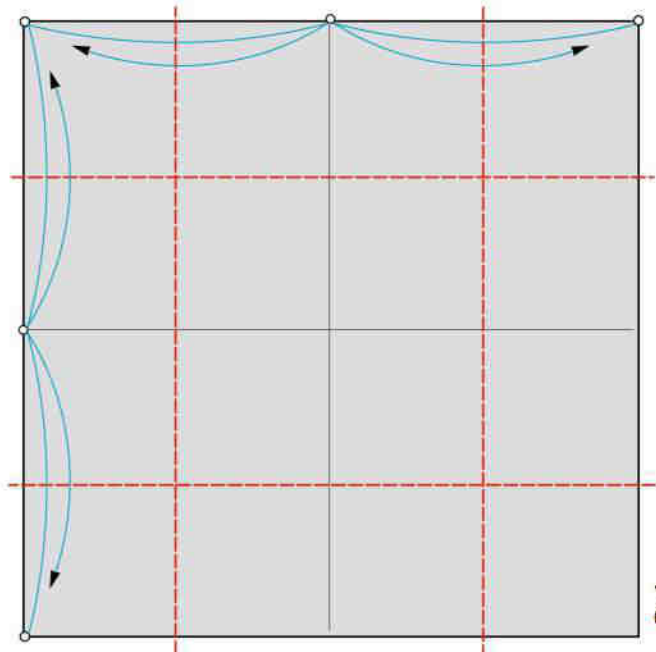

2

4 pieghe a valle

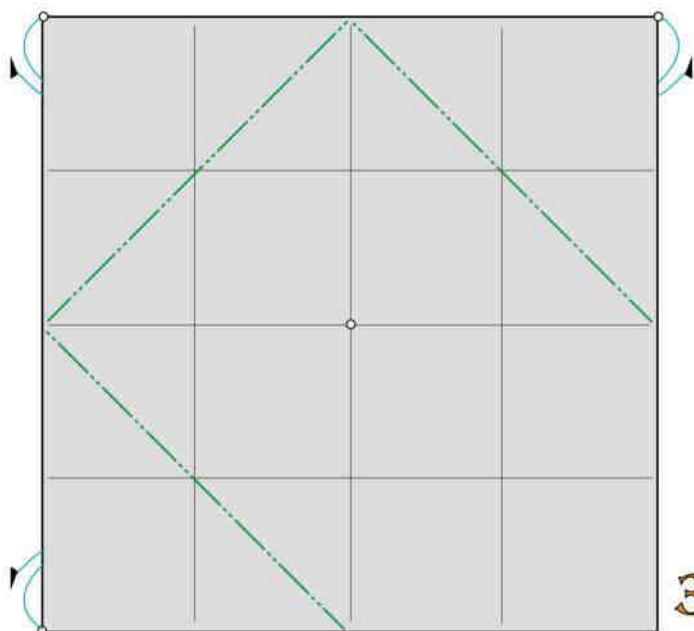

3

3 pieghe diagonali a monte

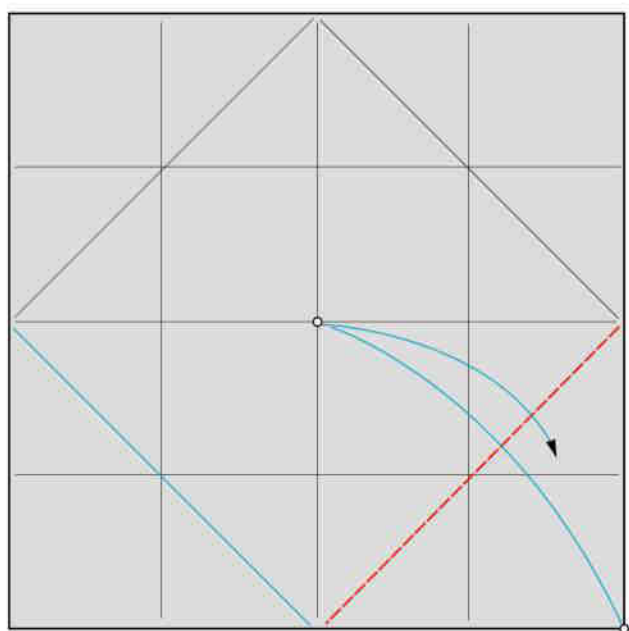

4

1 piega diagonale a valle

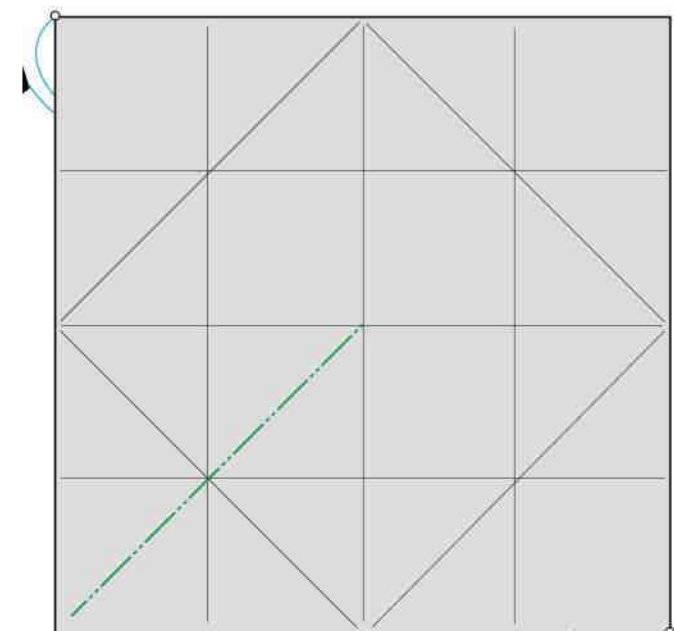

5

1 piega diagonale a monte

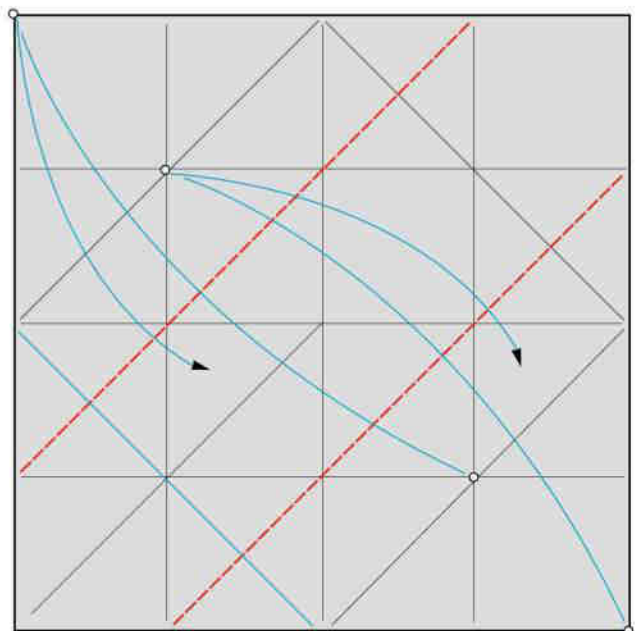

6

2 pieghe a valle

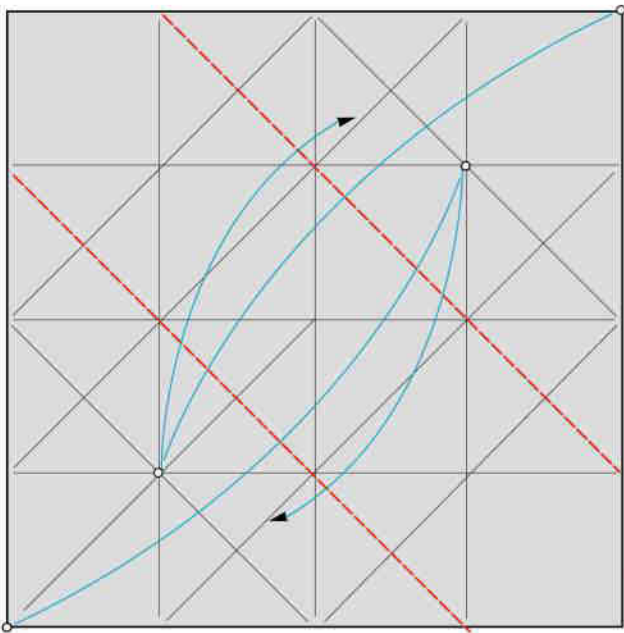

7

2 pieghe a valle

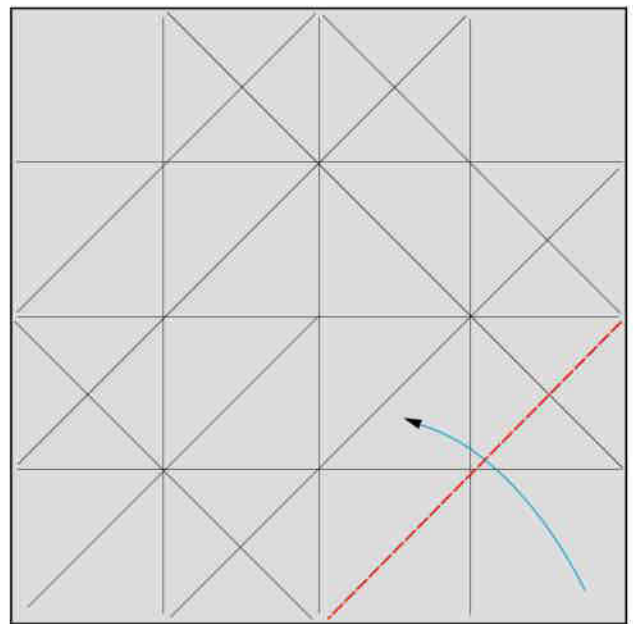

8

Ripiegate a valle

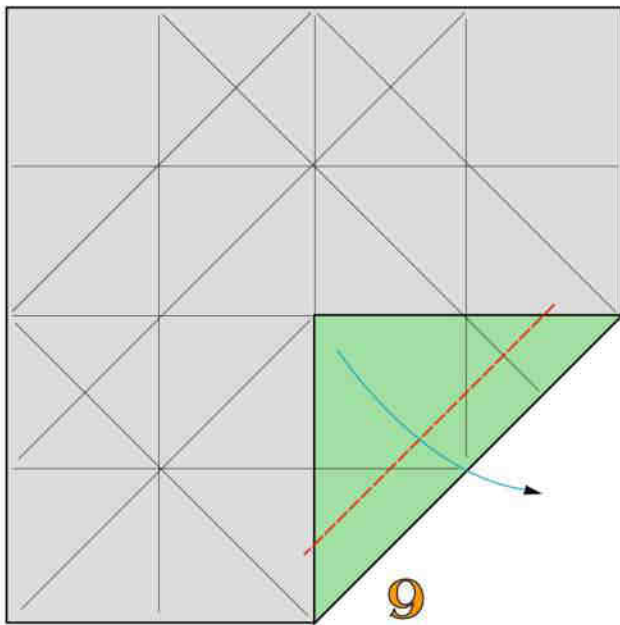

9

1 piega a valle

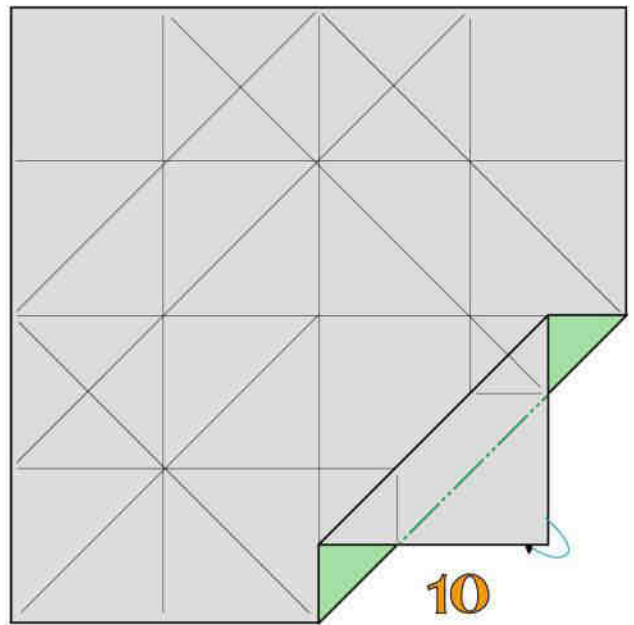

10

1 piega a monte

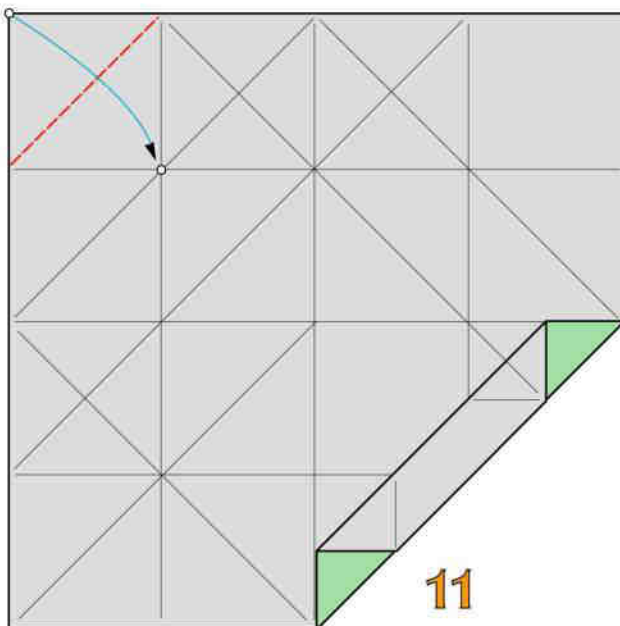

11

1 piega a valle

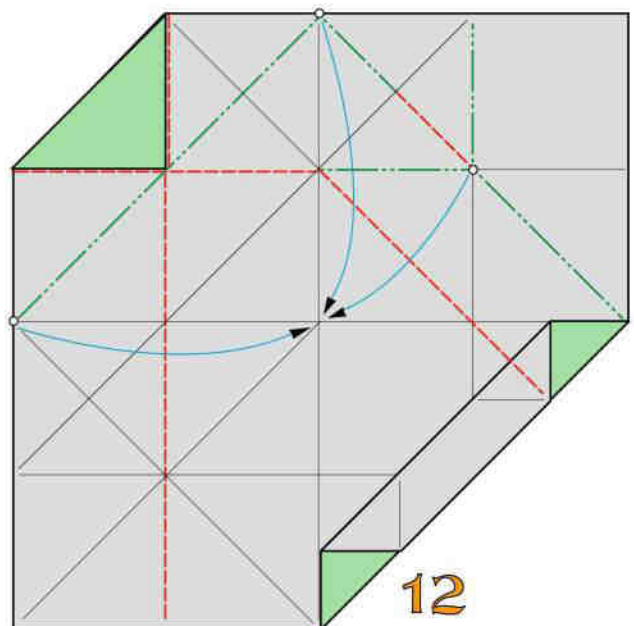

12

Ripiegate a valle e a monte

FORMAZIONE DEI MODULI COMPOSTI

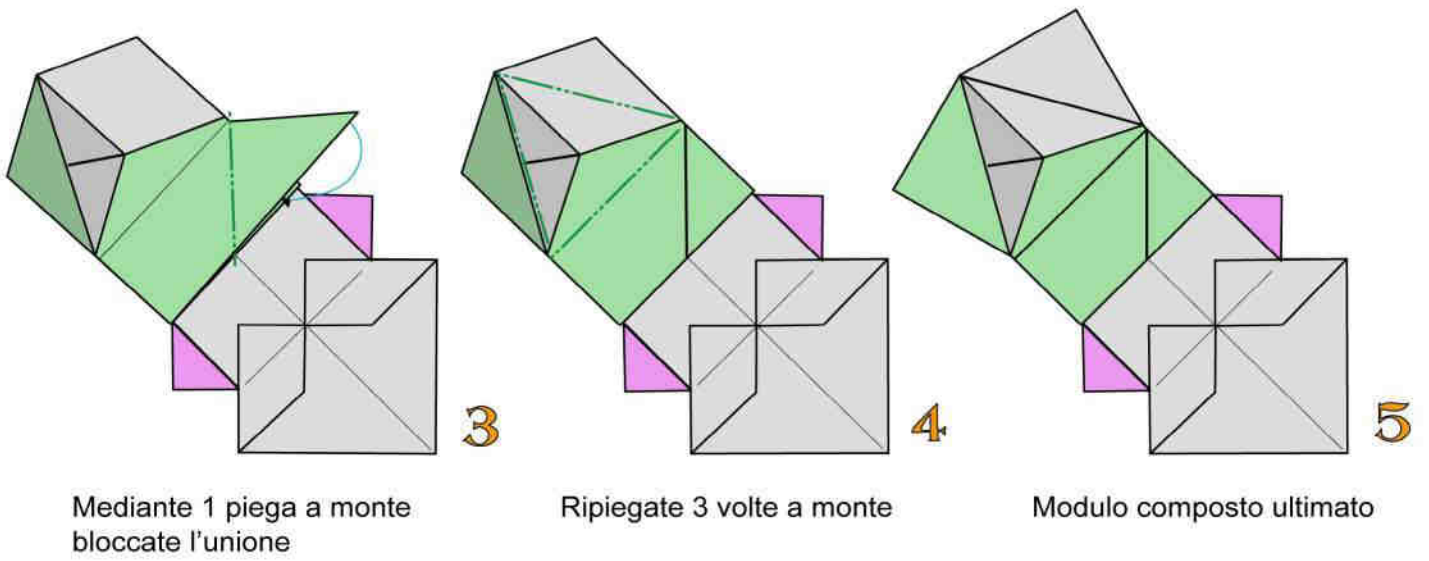
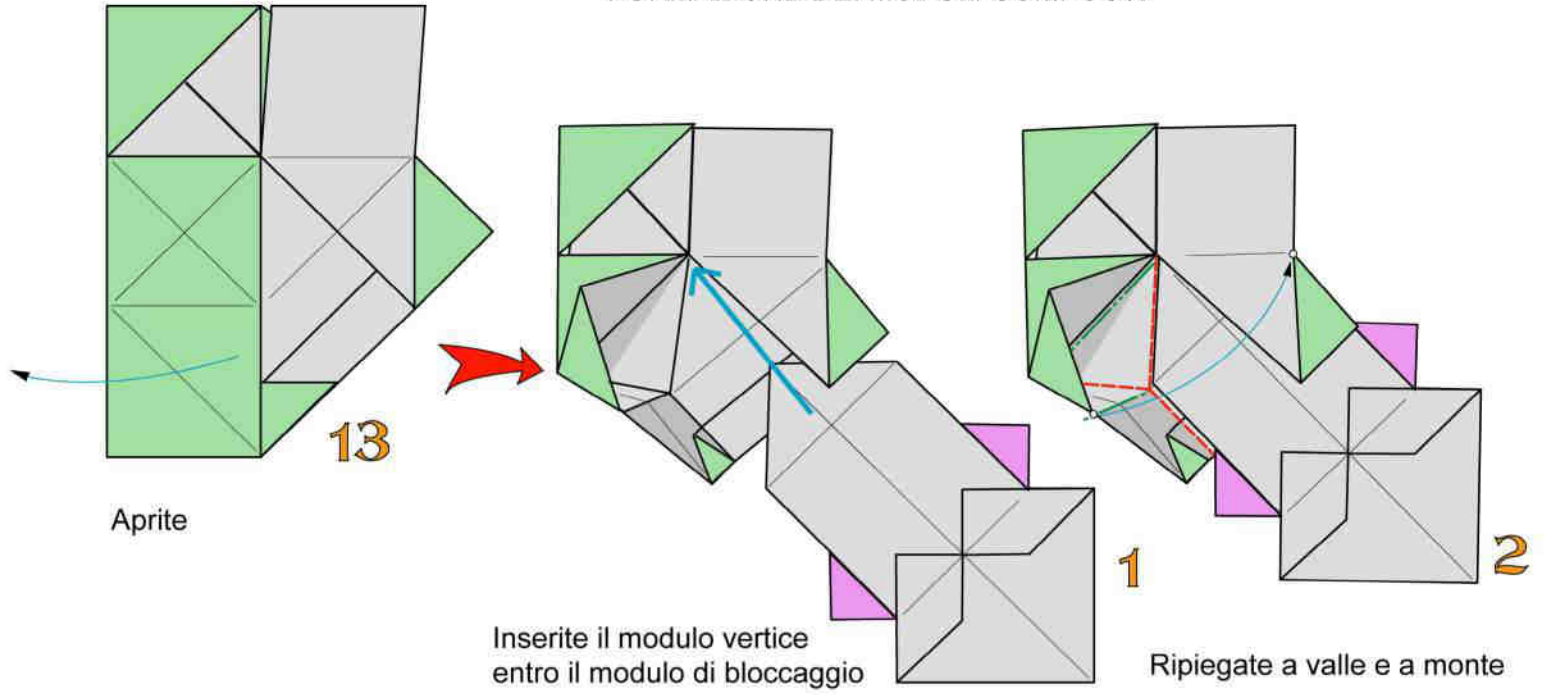

UNIONE DEI MODULI COMPOSTI

Inserite 1 vertice di un modulo nell'altro

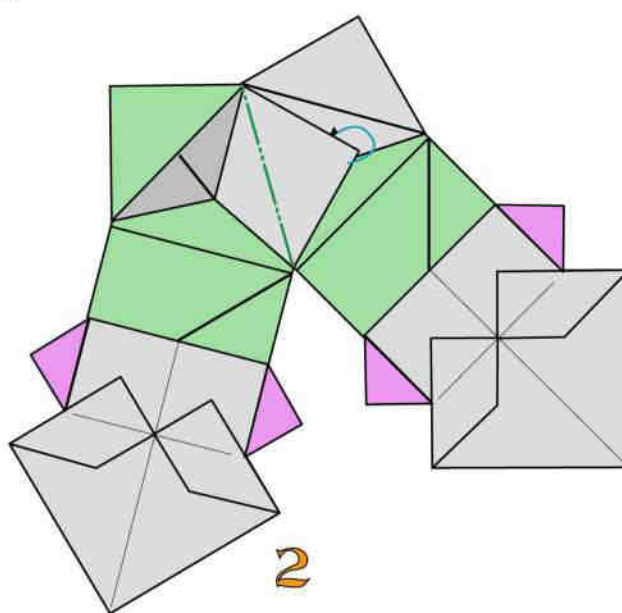
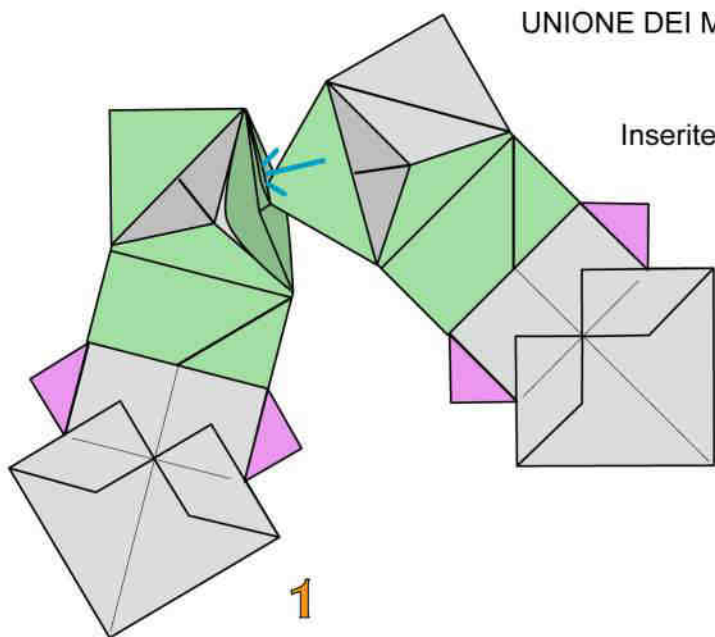

Ripiegando a monte intascate bloccando l'unione

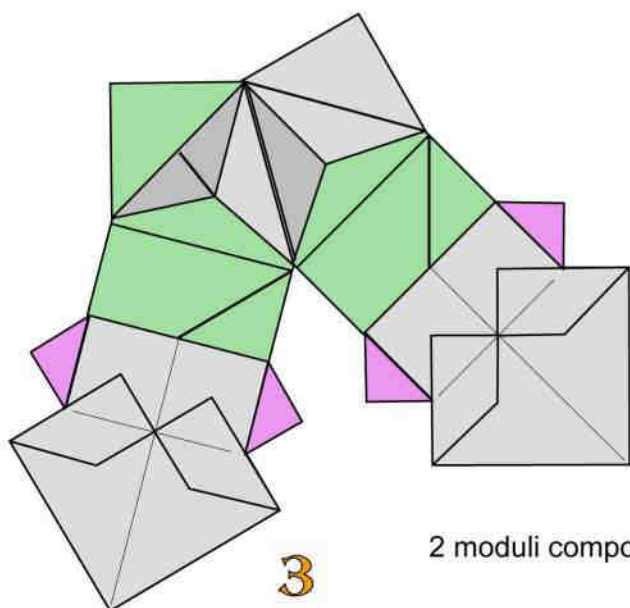

2 moduli composti uniti

DECORAZIONE ESAGONALE "C"

Franco Pavarin 24

La decorazione è costituita da 6 moduli composti formati da 1 modulo vertice "C" e 1 modulo di bloccaggio "A".

Per la costruzione dei moduli adoperate carta monocoloro di medio peso.

Il formato per tutti i moduli è di 10x10 cm.

Costruzione per origamisti esperti.

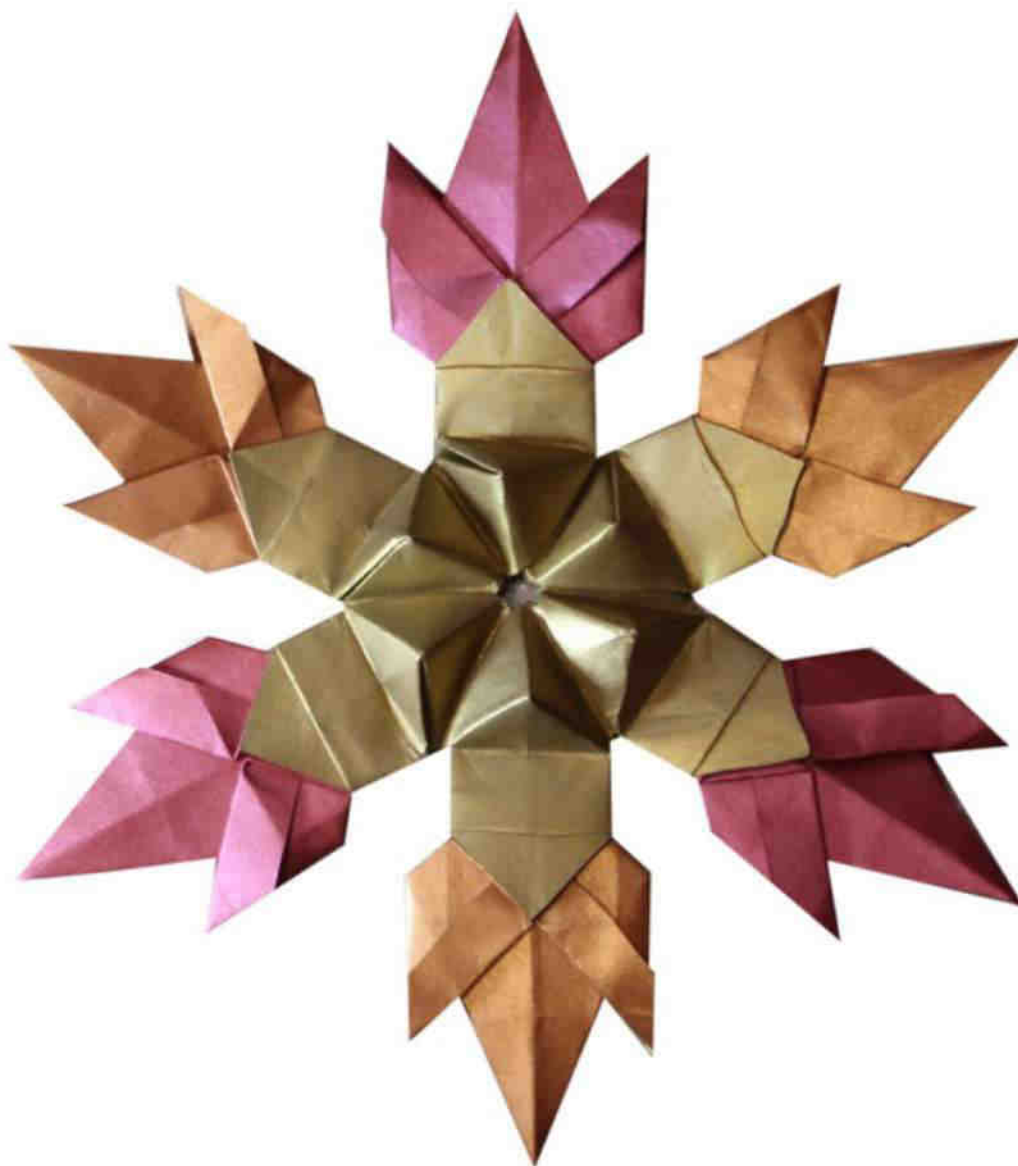

MODULO VERTICE "C"

1 piega diagonale a valle e 1 a monte

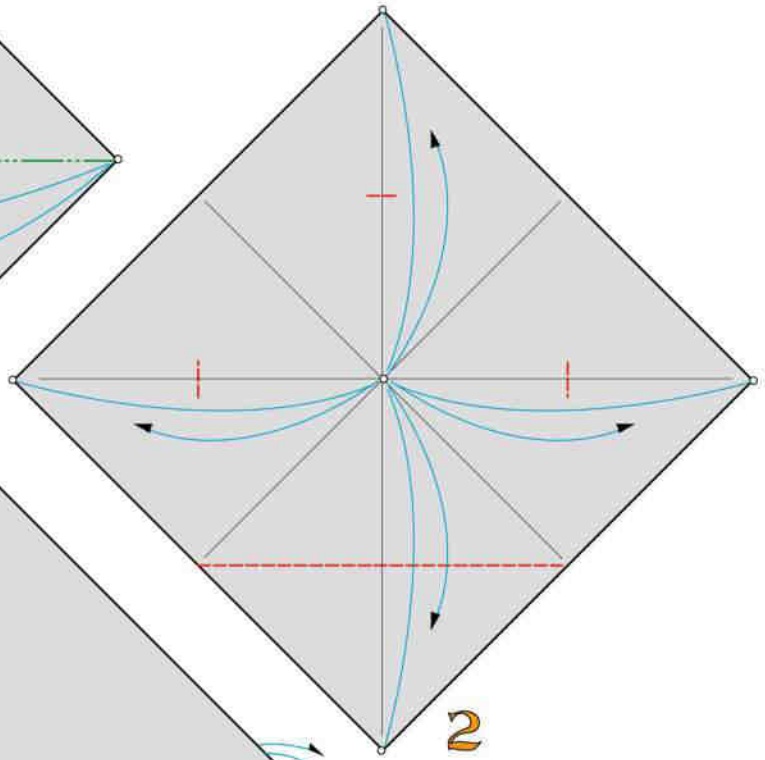
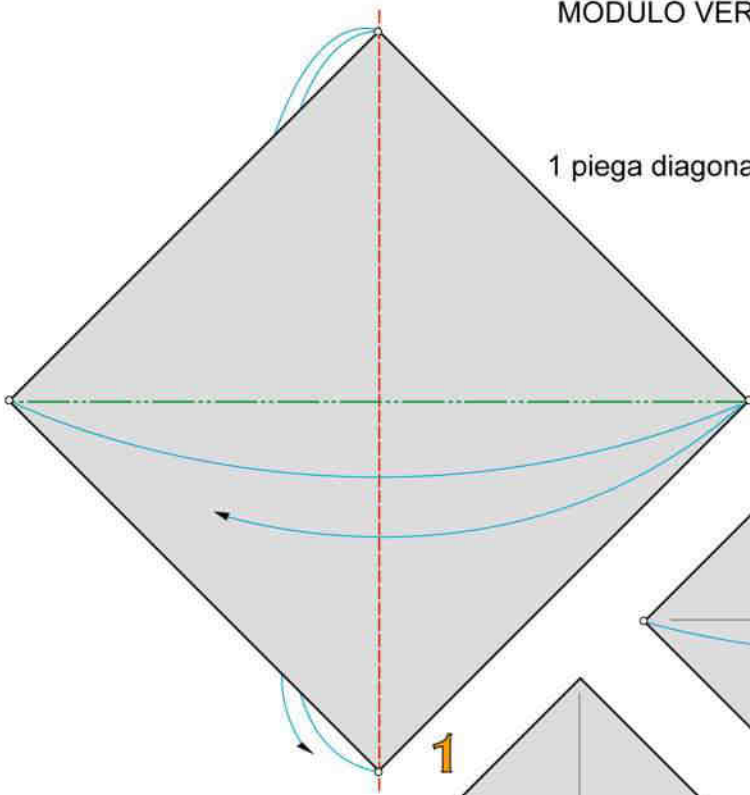

4 pieghe a valle, di cui 3 piccole

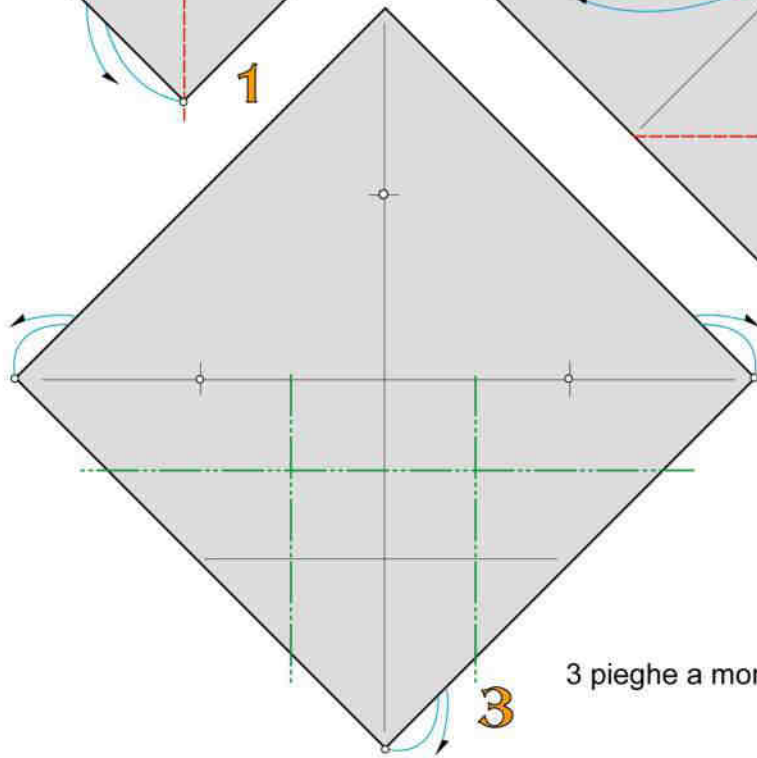

3 pieghe a monte

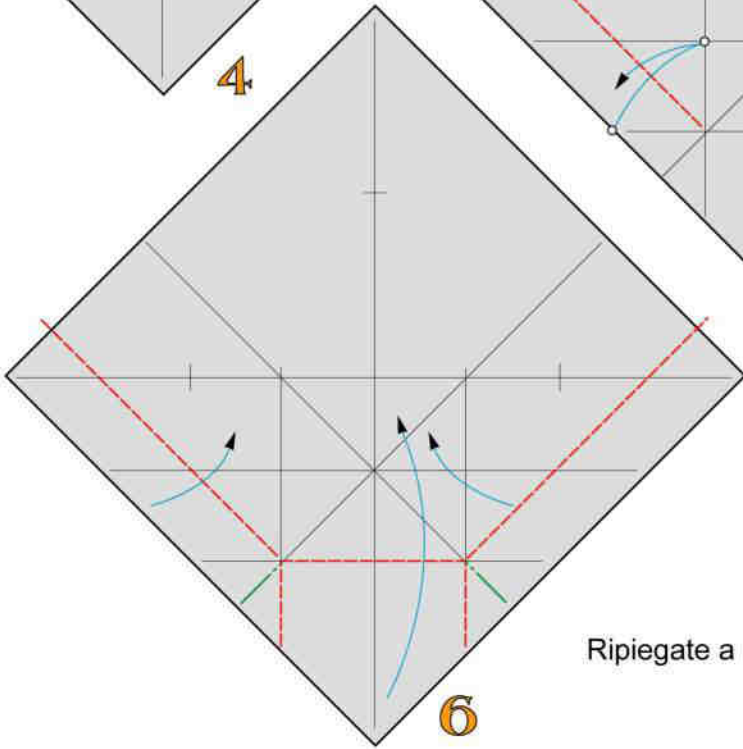
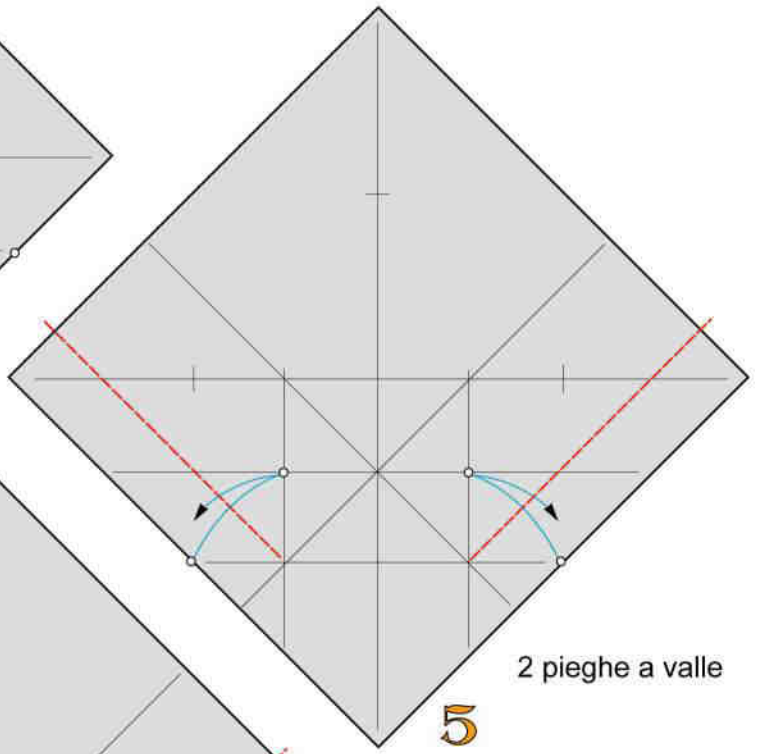
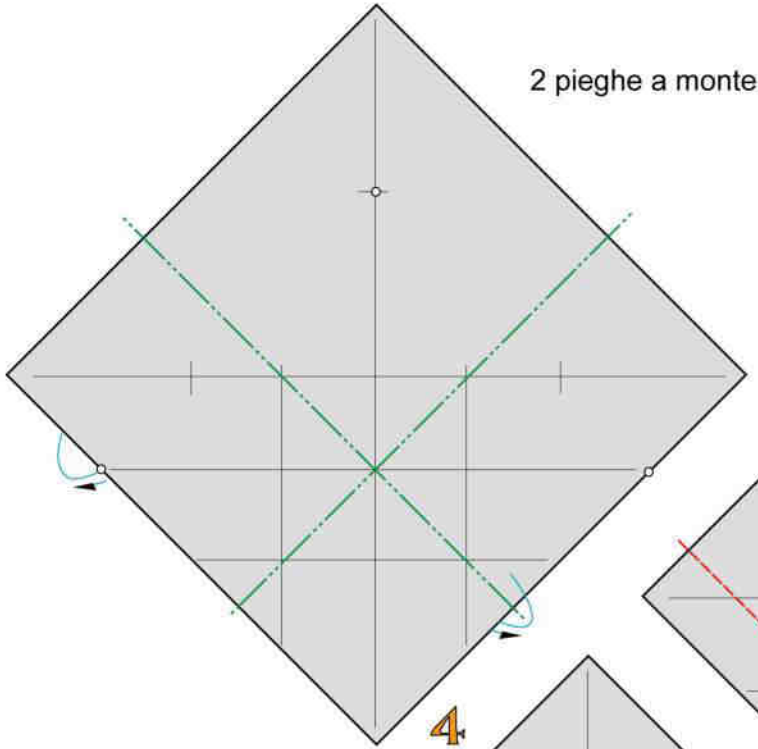

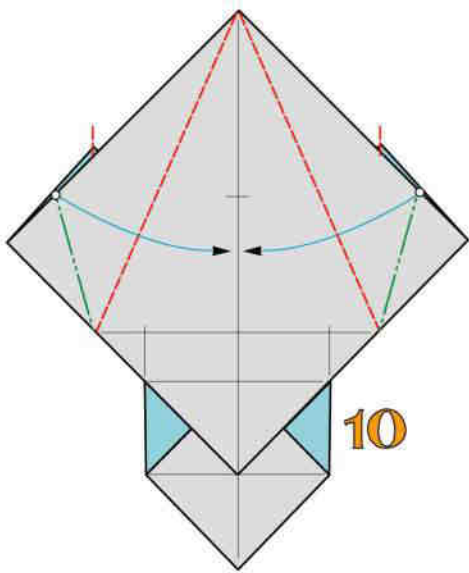
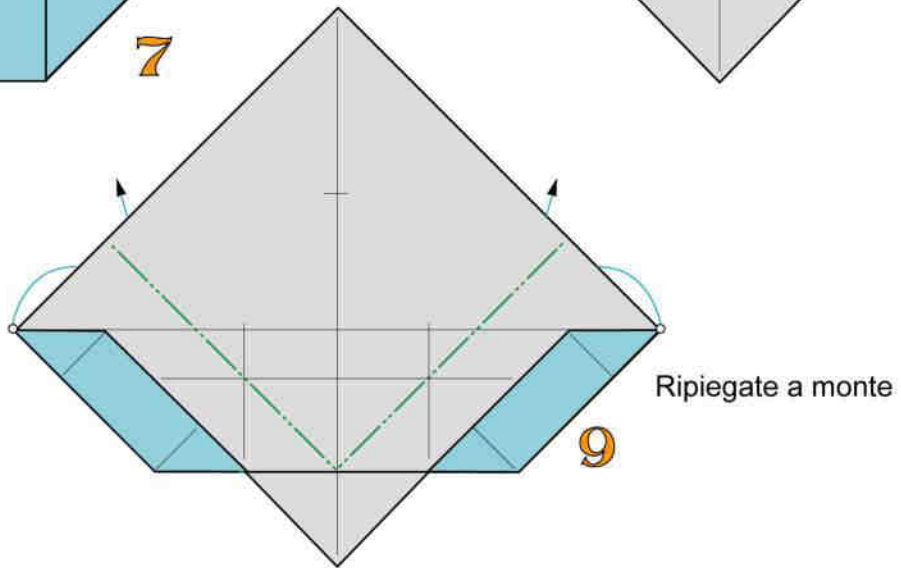
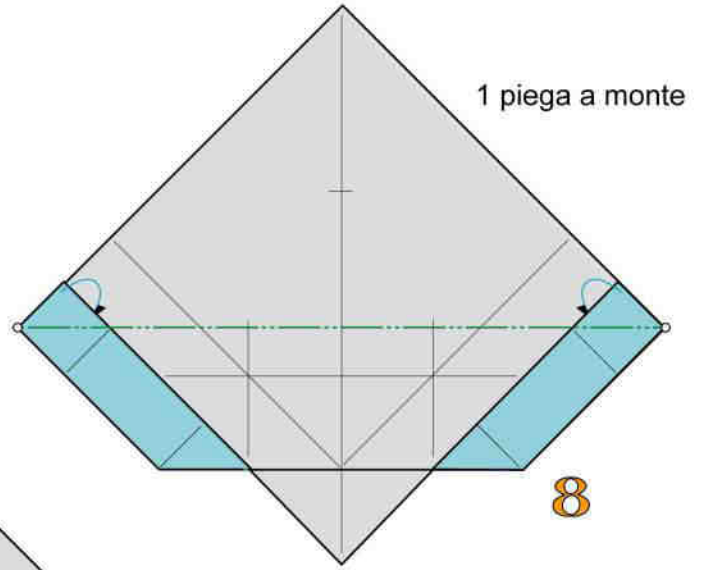
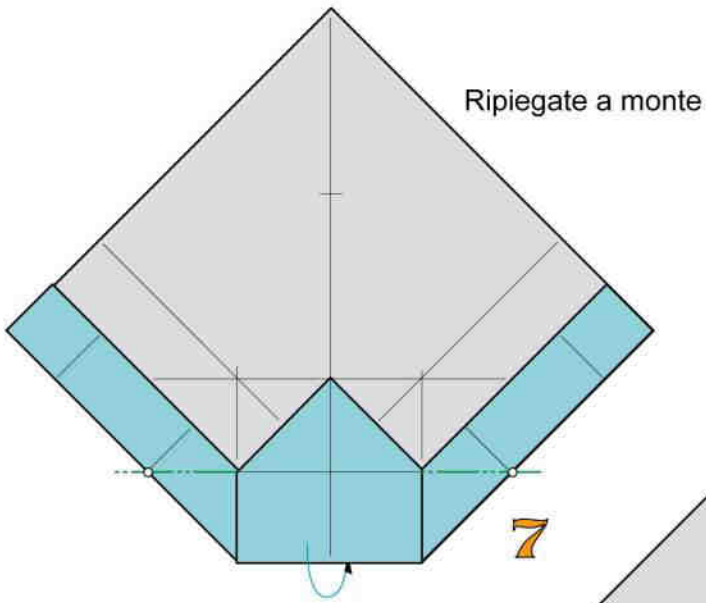

4 pieghe a valle e 2 a monte

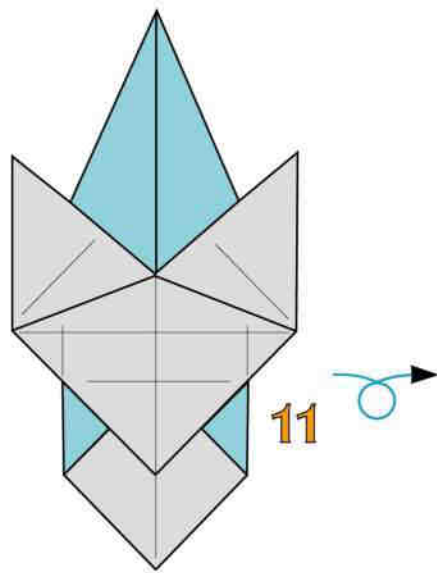

Modulo vertice "C" ultimato. Ribaltate

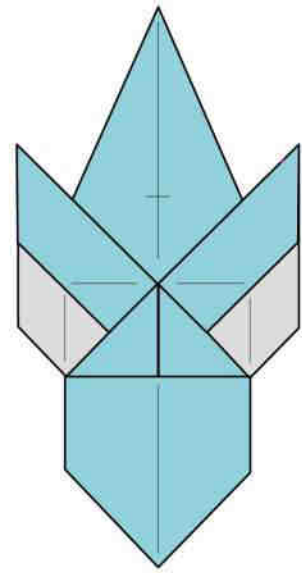

FORMAZIONE DEI MODULI COMPOSTI

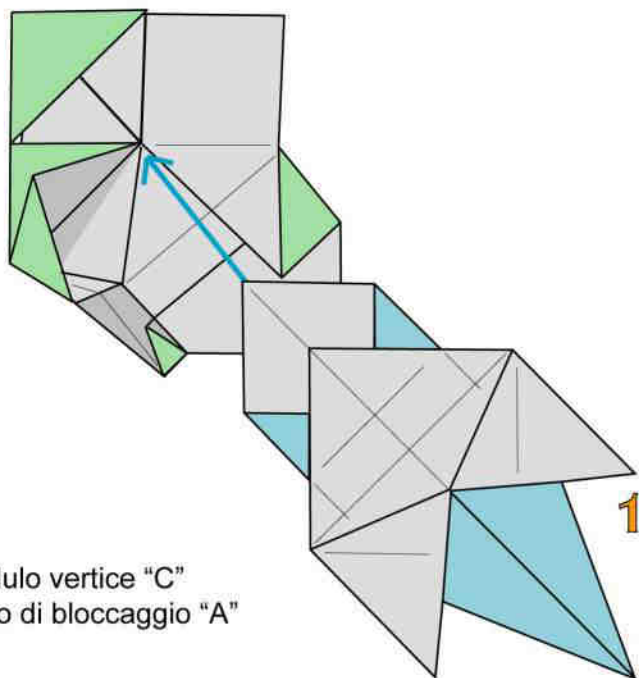

Inserite il modulo vertice "C"
entro il modulo di bloccaggio "A"

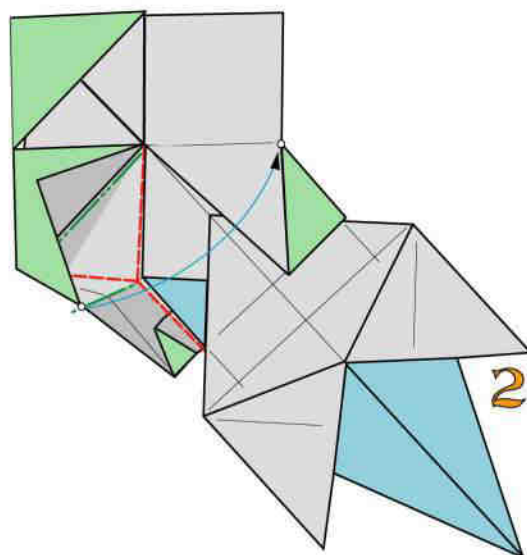

Ripiegate a valle e a monte

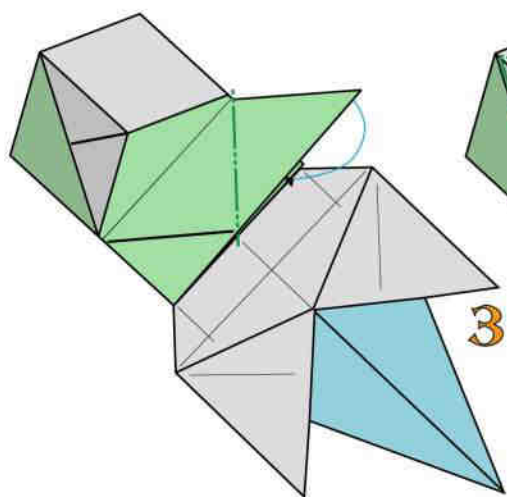

Intascate 1 piega a monte
bloccando l'unione

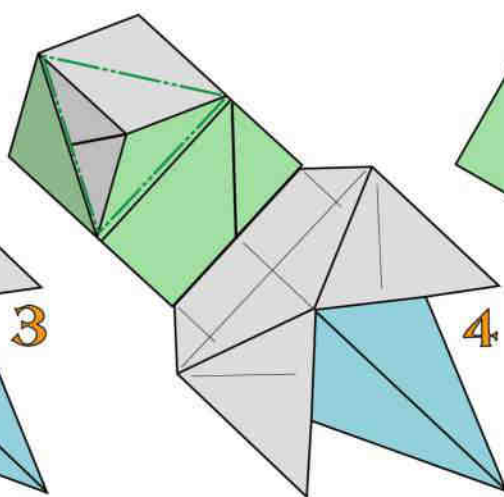

Ripiegate 3 volte a monte

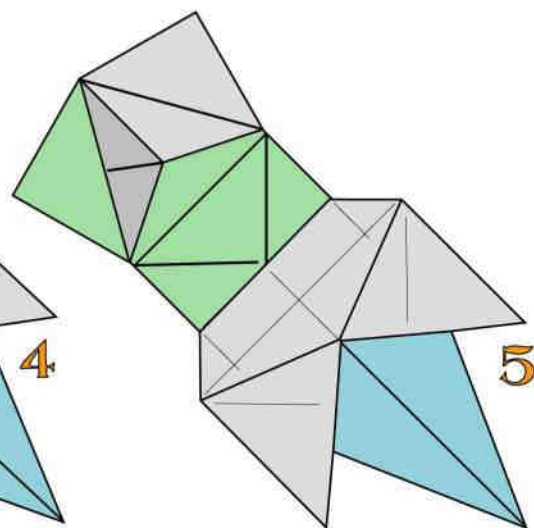

Modulo composto ultimato

UNIONE DEI MODULI COMPOSTI

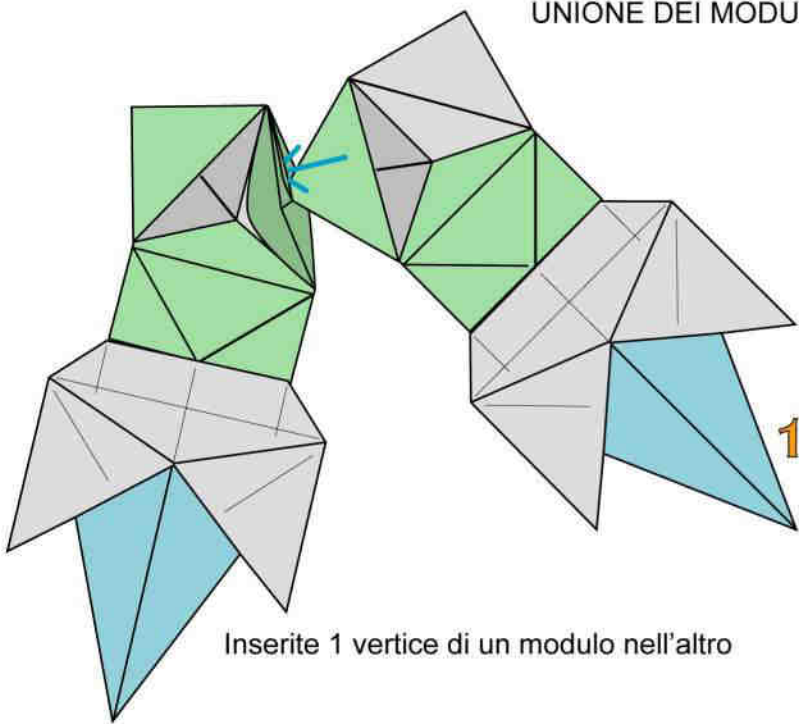

Inserite 1 vertice di un modulo nell'altro

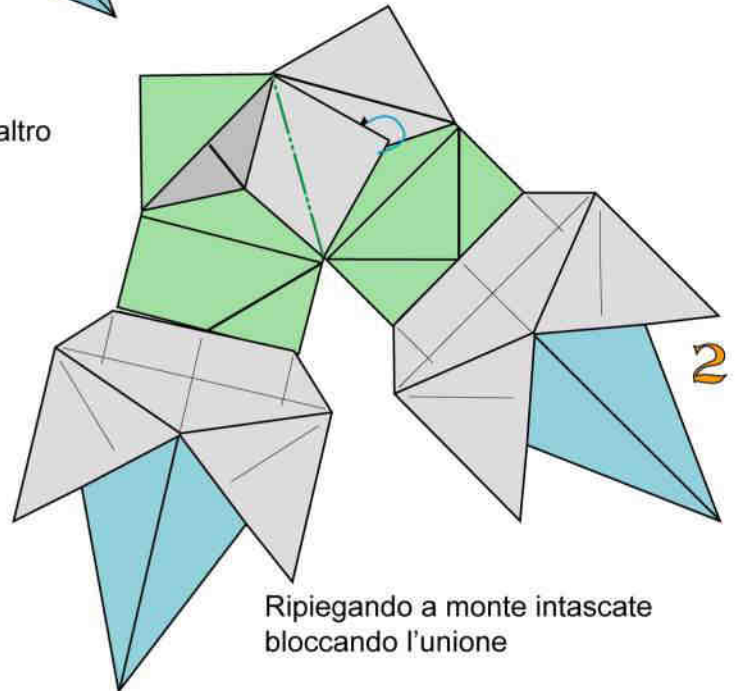

Ripiegando a monte intascate bloccando l'unione

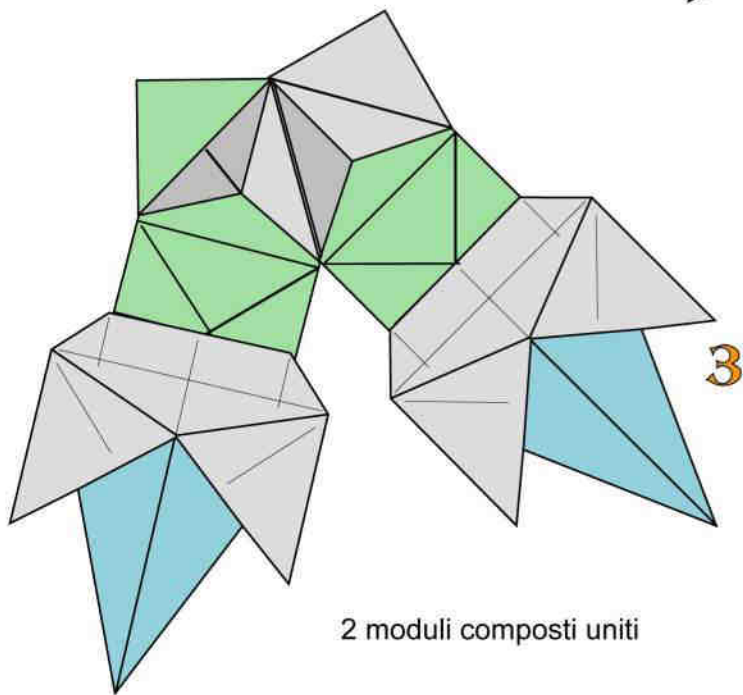

2 moduli composti uniti

STELLA A 5 PUNTE

Franco Pavarin 24

Di costruzione molto semplice, questa stella ha bisogno di fogli di almeno 10 cm di lato.
Con fogli più piccoli, risulterebbe complicato eseguire l'ultimo bloccaggio.
Adoperate carta monocolora o bicolore di medio peso.

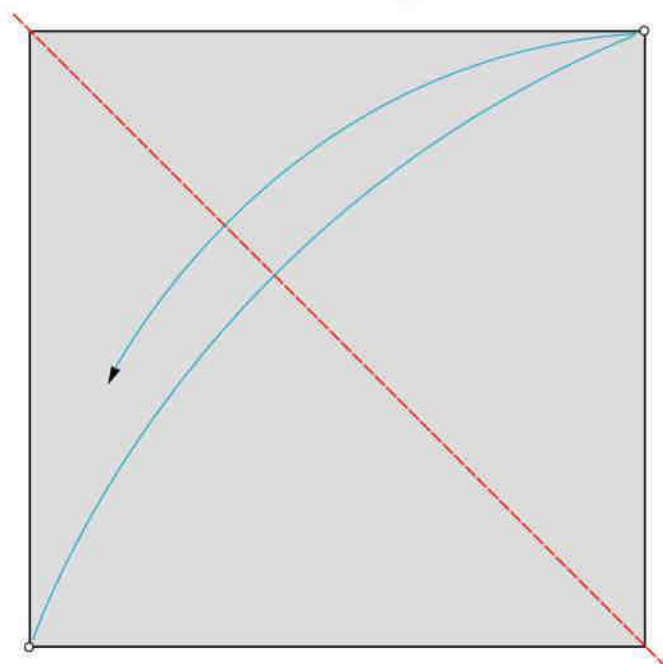
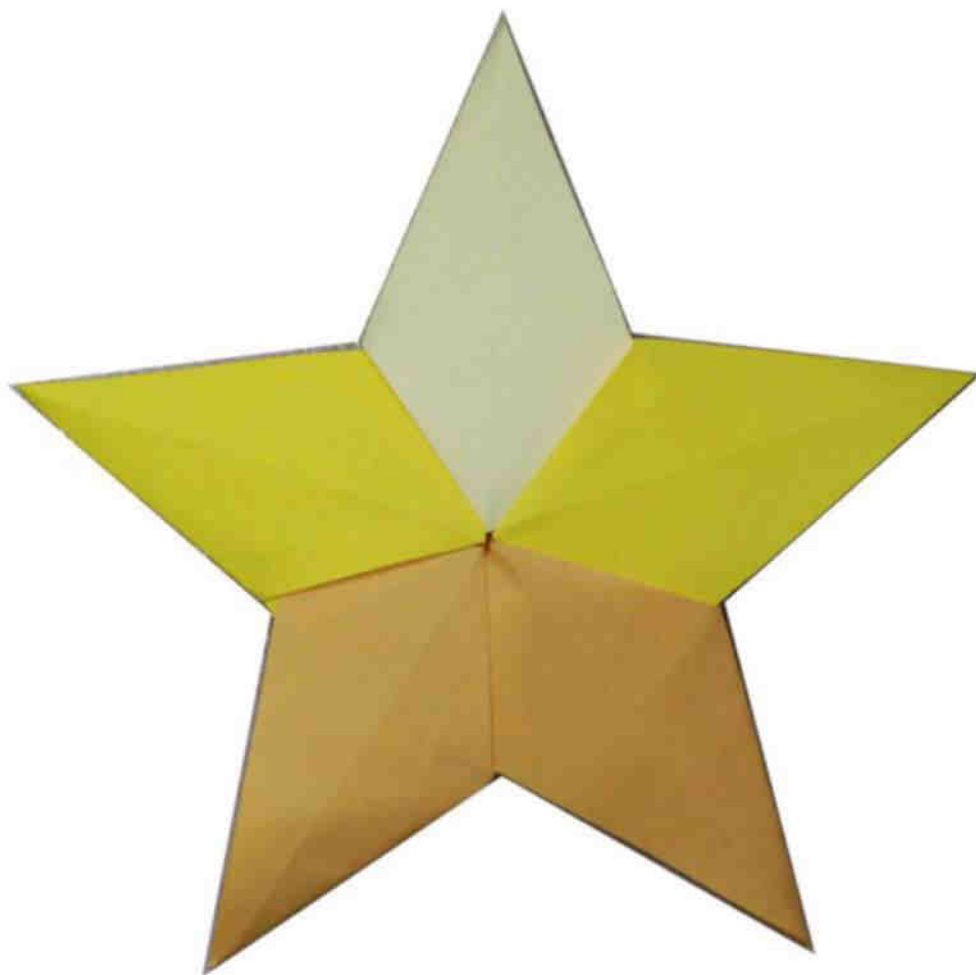

1 piega diagonale a valle

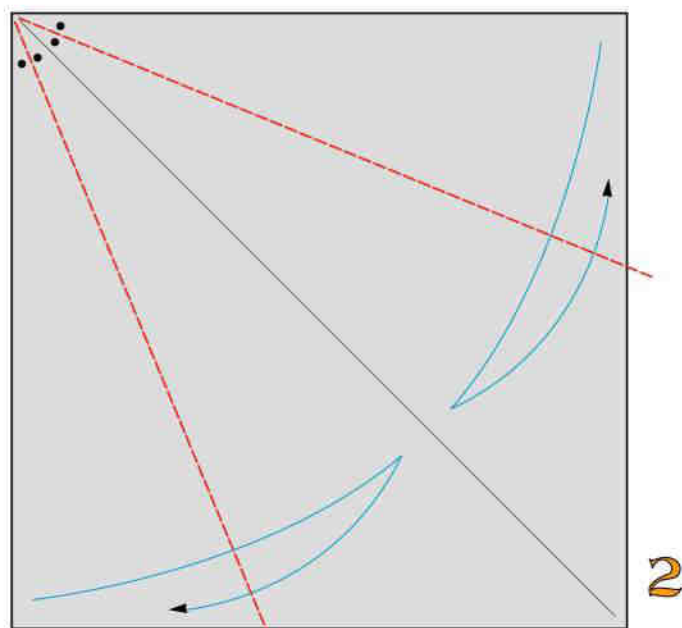

2 pieghe bisettrici a valle

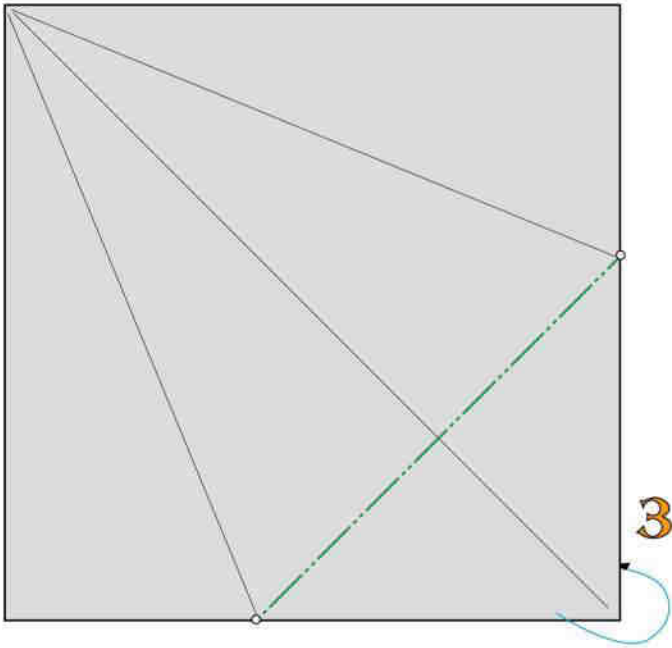

1 piega a monte

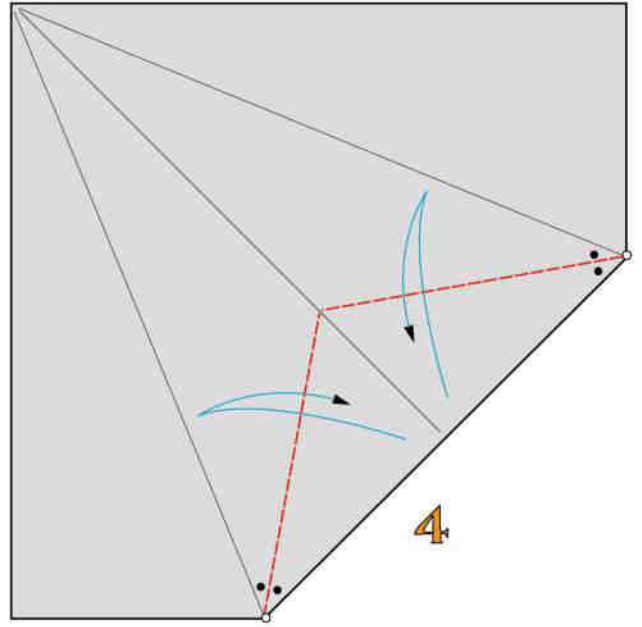

2 pieghe bisettrici a valle

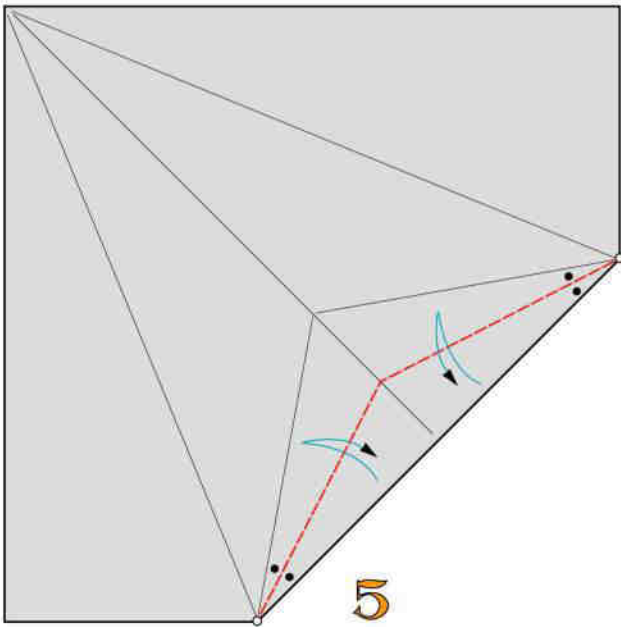

2 pieghe bisettrici a valle

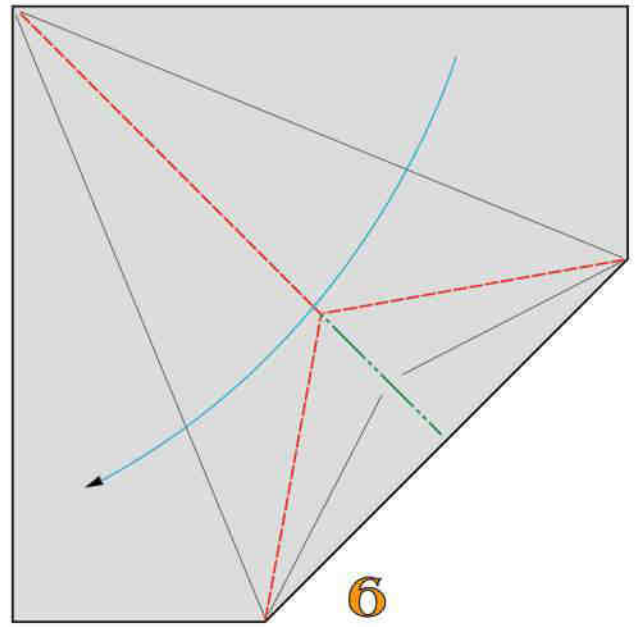

Ripiegate a valle e a monte

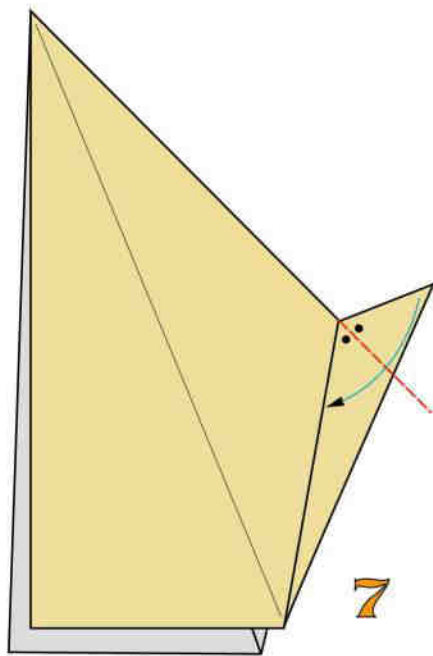

1 piega bisettrice a valle

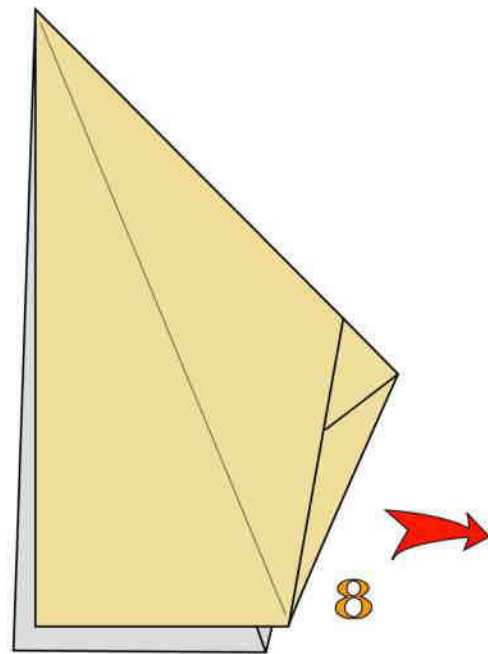

Modulo stella a 5 punte ultimato.

UNIONE DEI MODULI

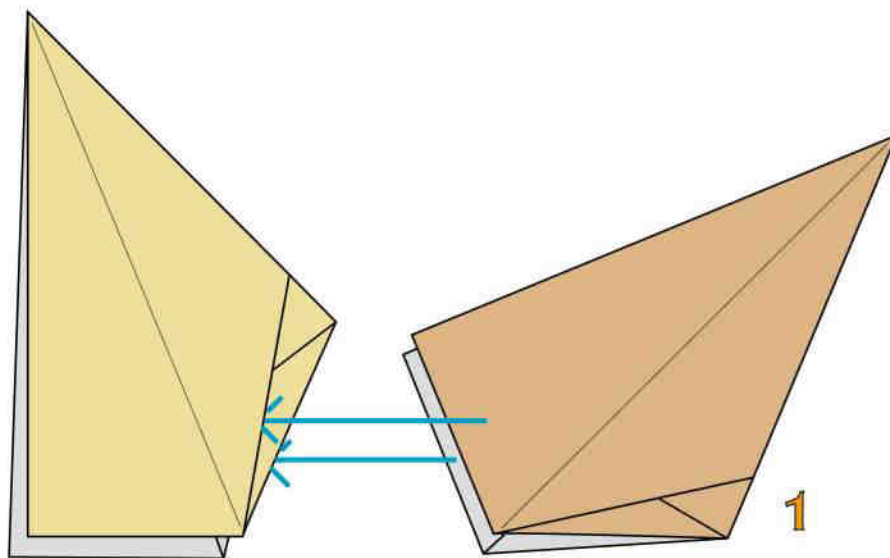

Inserite le 2 appendici nelle 2 tasche

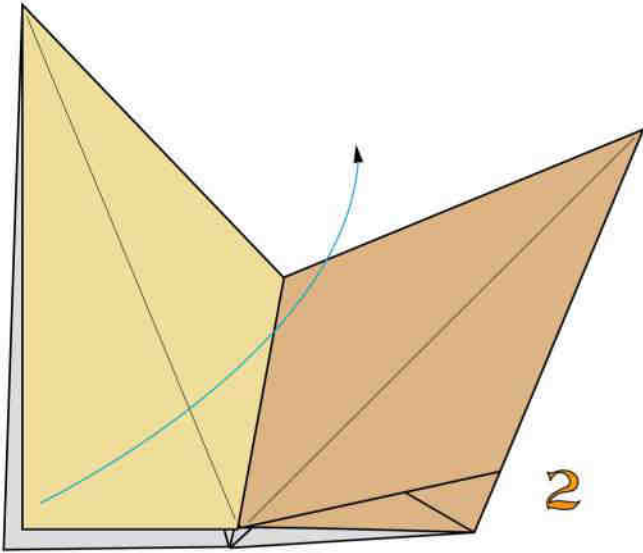

Aprite

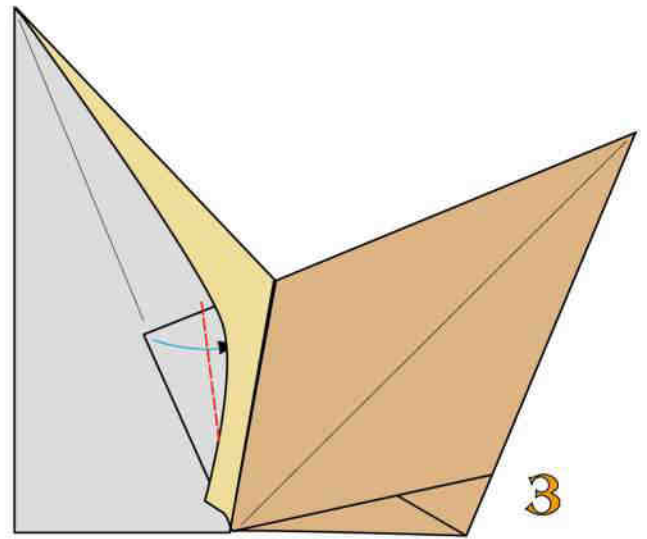

1 piega bisettrice a valle

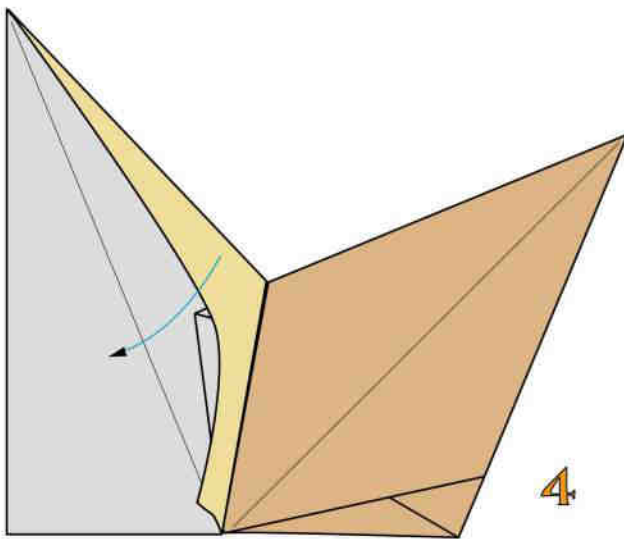

Richiudete

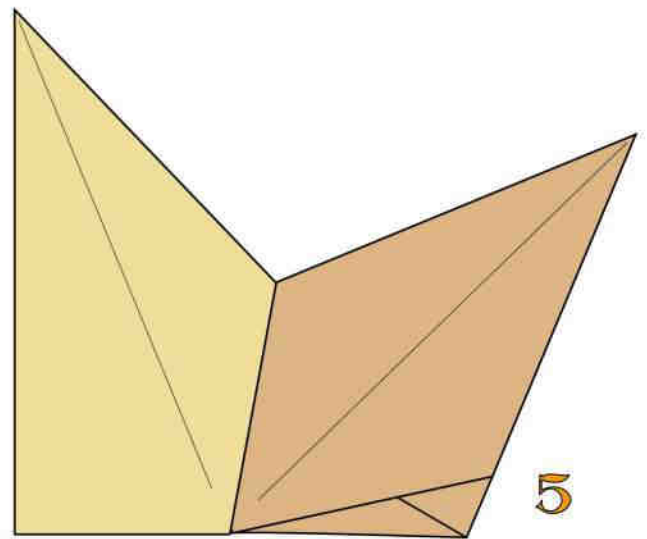

Unione di 2 moduli di stella a 5 punte ultimata

COMPOSIZIONE MODULARE CIRCOLARE CON 7 BRACCI

Franco Pavarin 24

Si ottiene unendo 7 moduli costruiti con carta monocolore da 120 gr di peso e di 8x8 cm di dimensione.

Costruzione per piegatori esperti



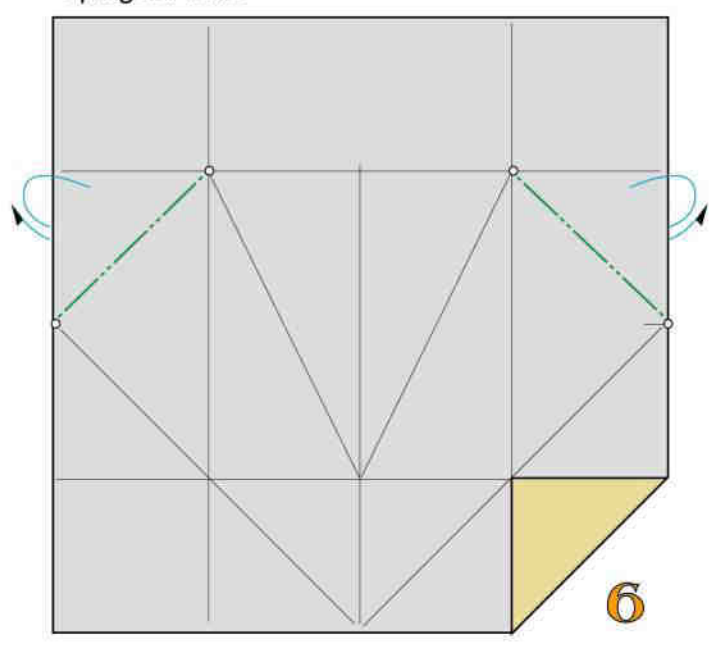
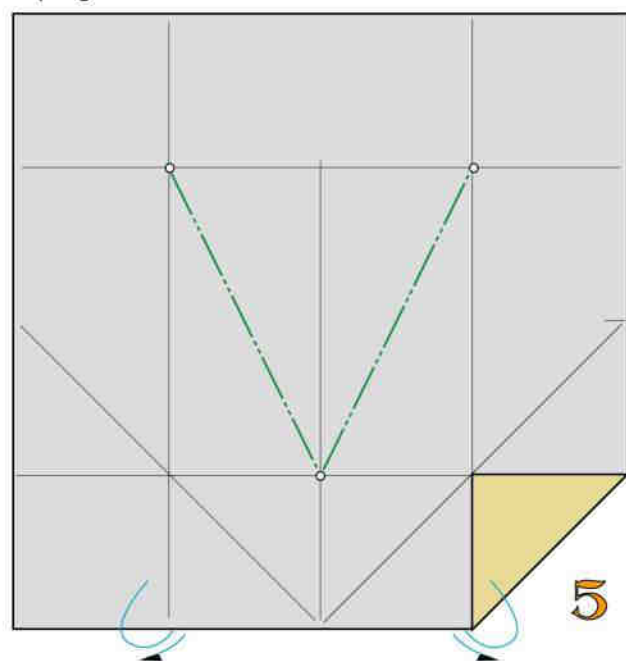
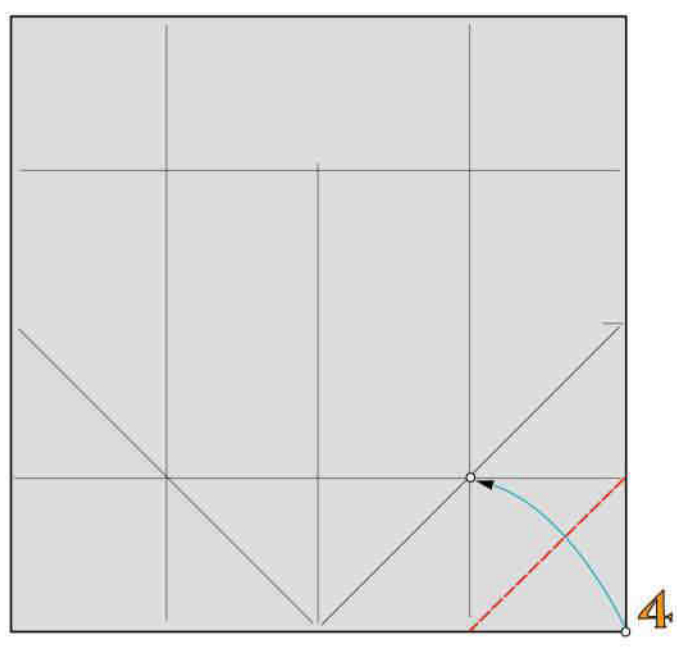
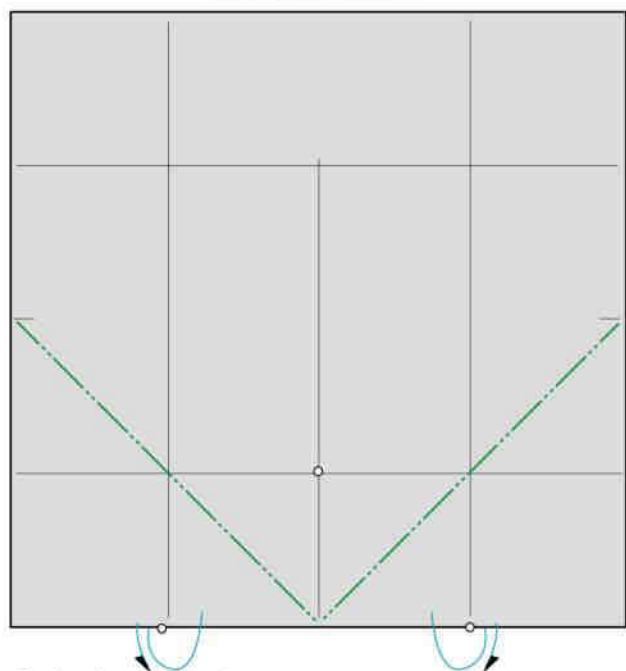
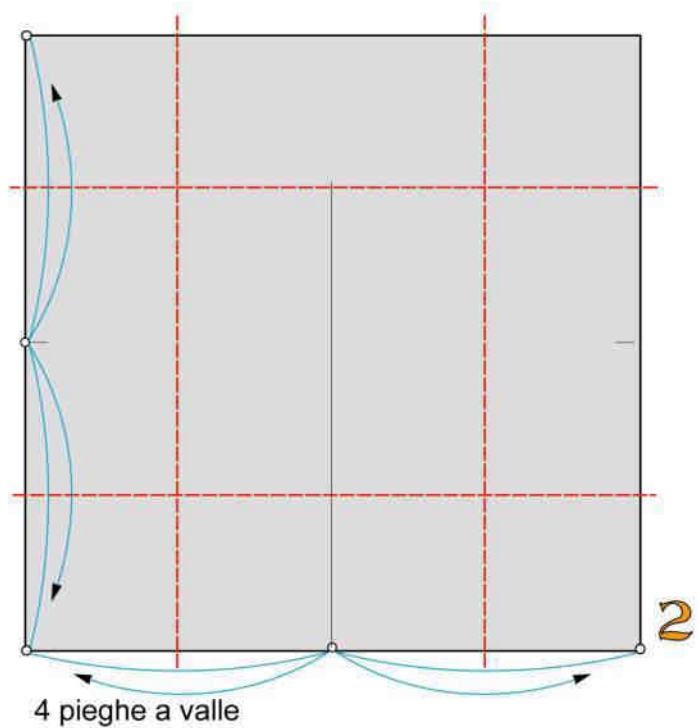
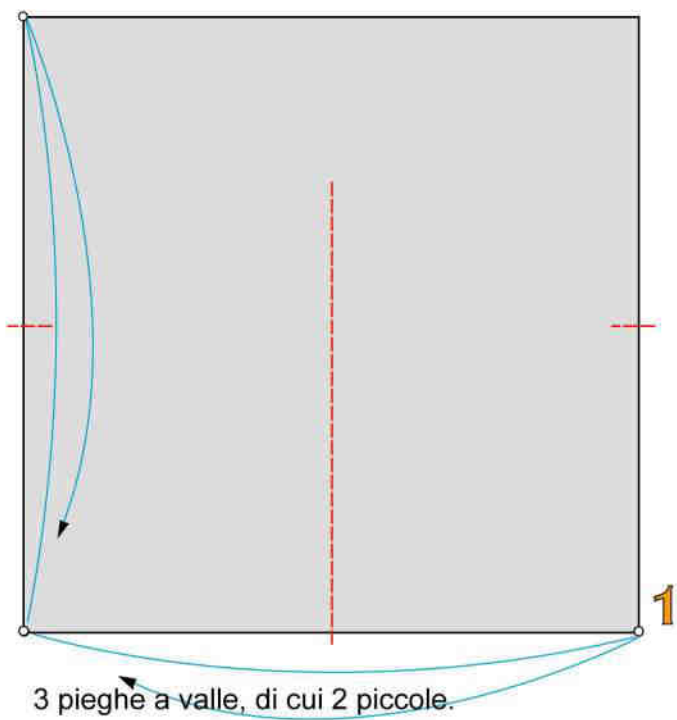

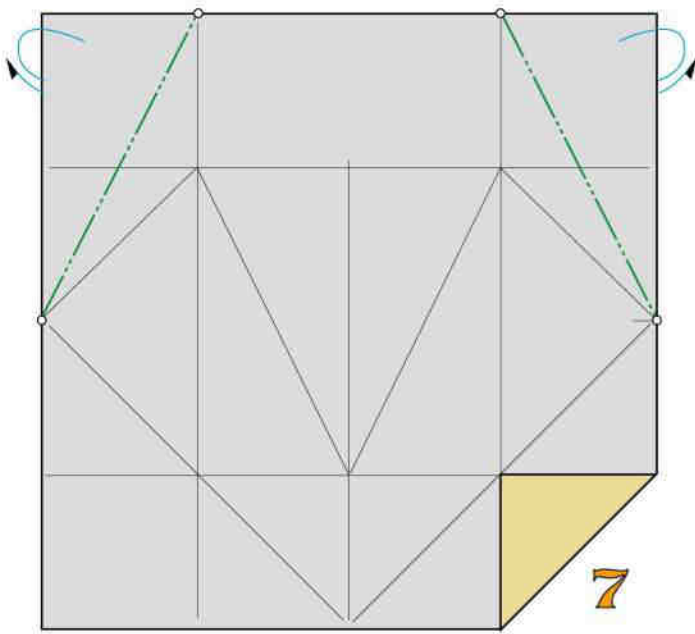

7

2 pieghe a monte

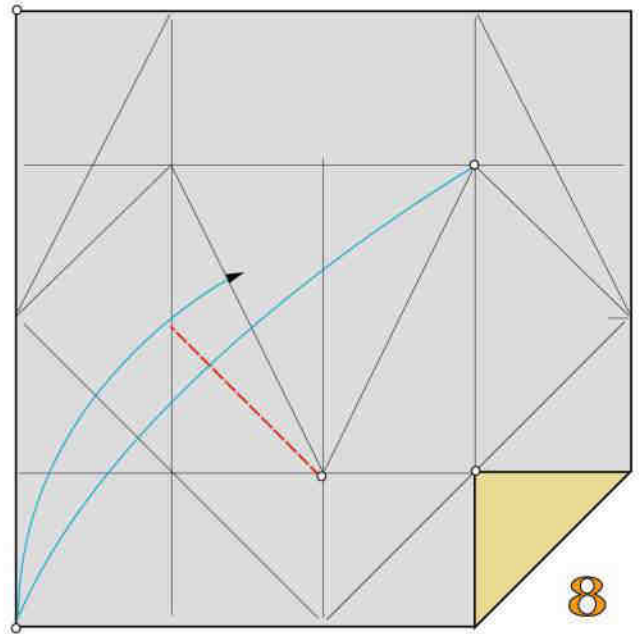

8

1 piega a valle

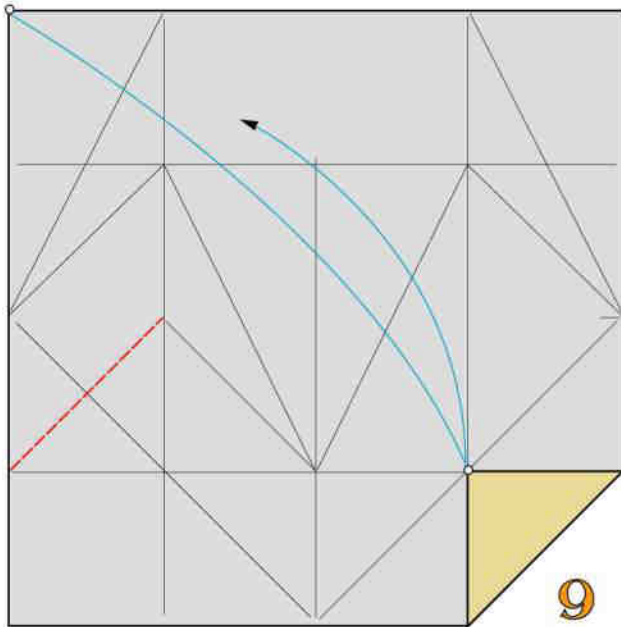

9

1 piega a valle

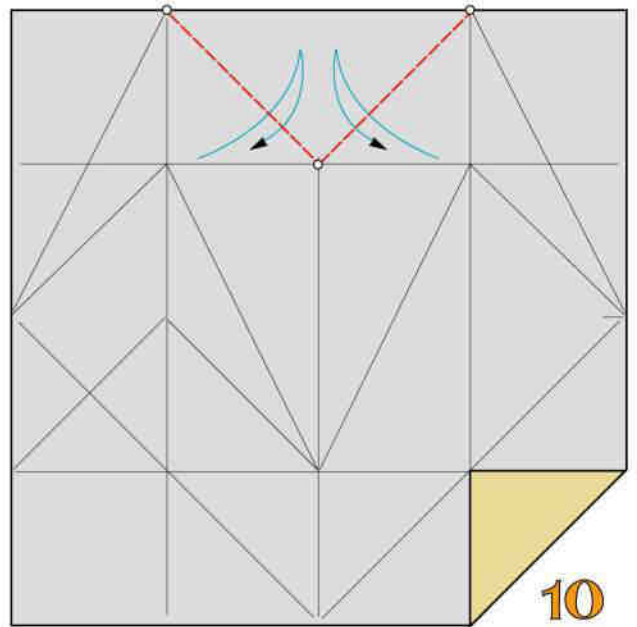

10

2 pieghe a valle

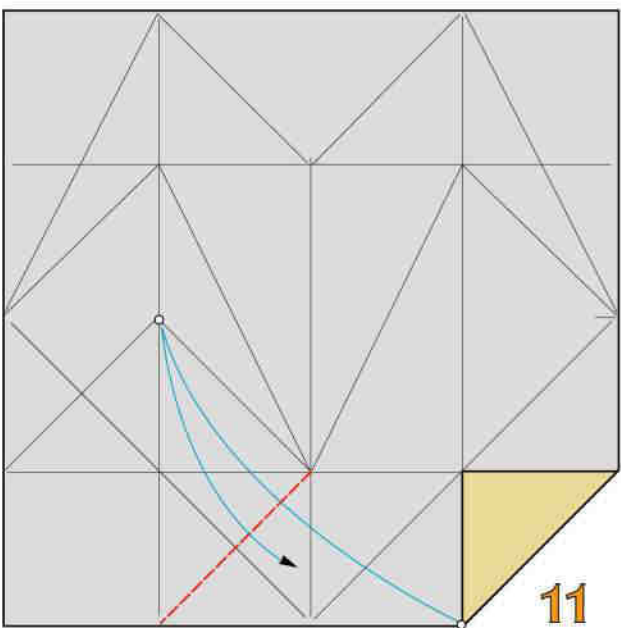

11

1 piega a valle

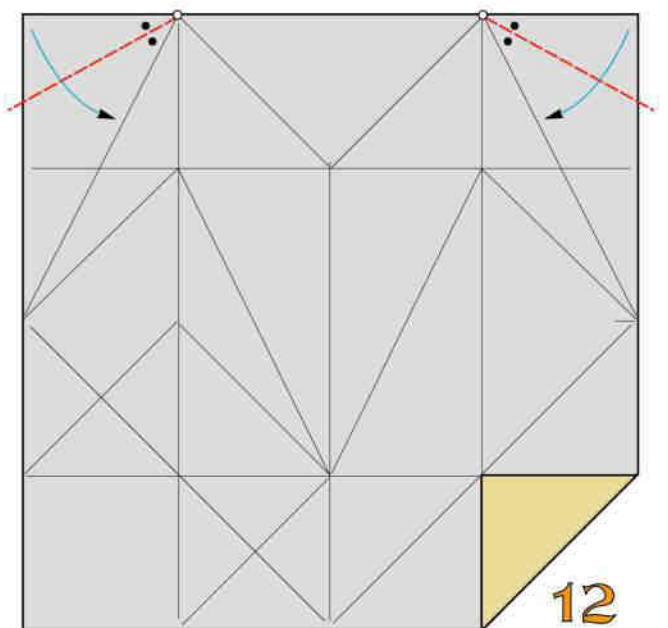

12

2 pieghe bisettrici a valle

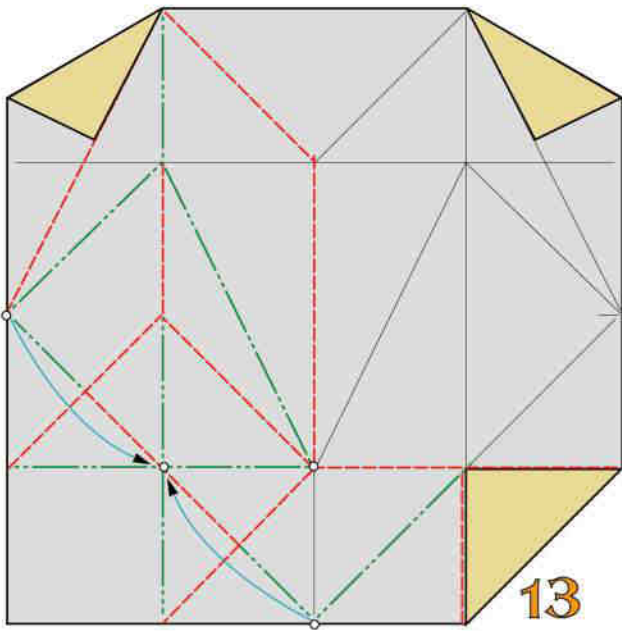

13

Ripiegate a valle e a monte modellando 3D

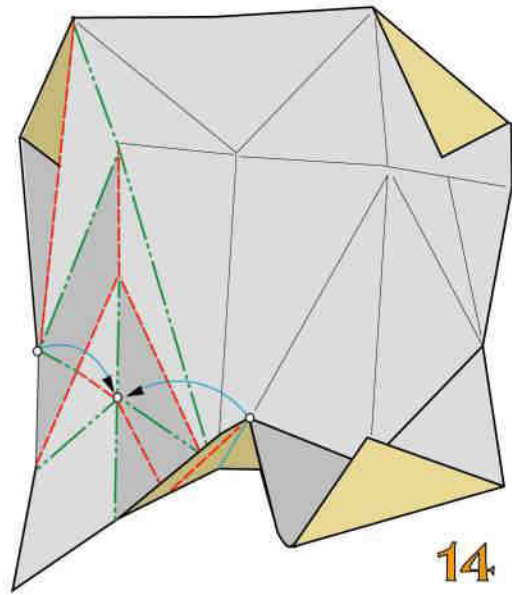

14

Ripiegate a valle e a monte modellando 3D

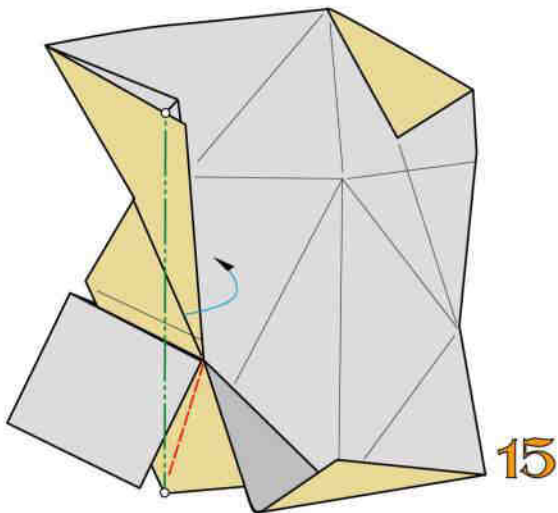

15

1 piega a monte a ridosso dello spigolo sottostante

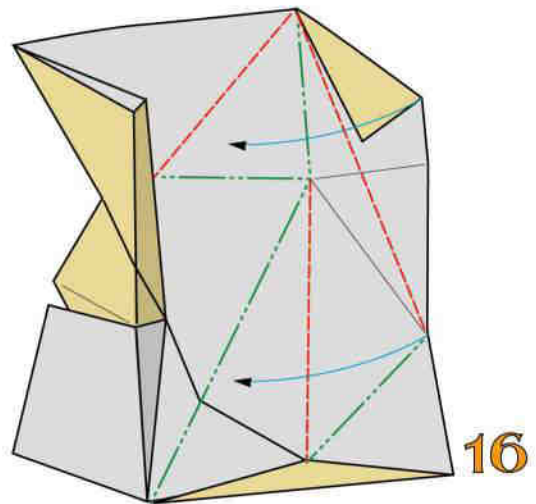

16

Ripiegate a valle e a monte modellando 3D

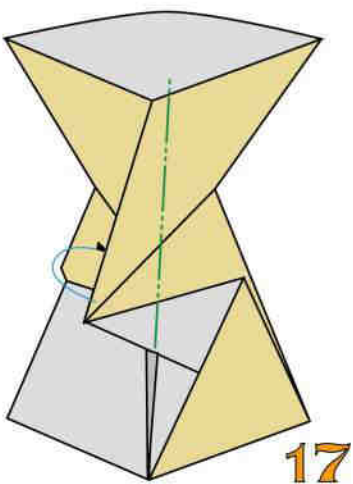

17

1 piega a monte a ridosso dello spigolo sottostante

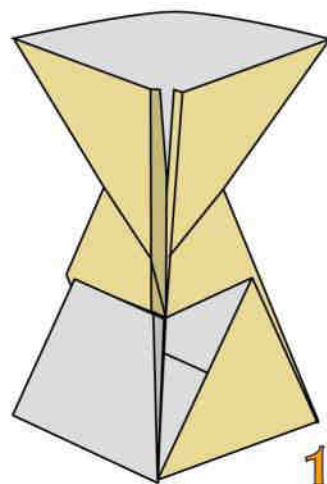

18

Modulo completato. Ribaltate

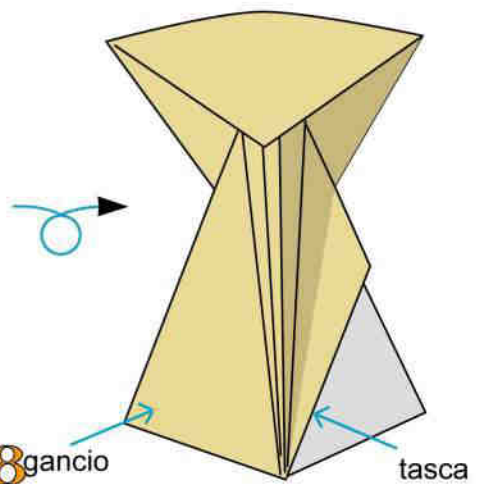

tasca

UNIONE DEI MODULI

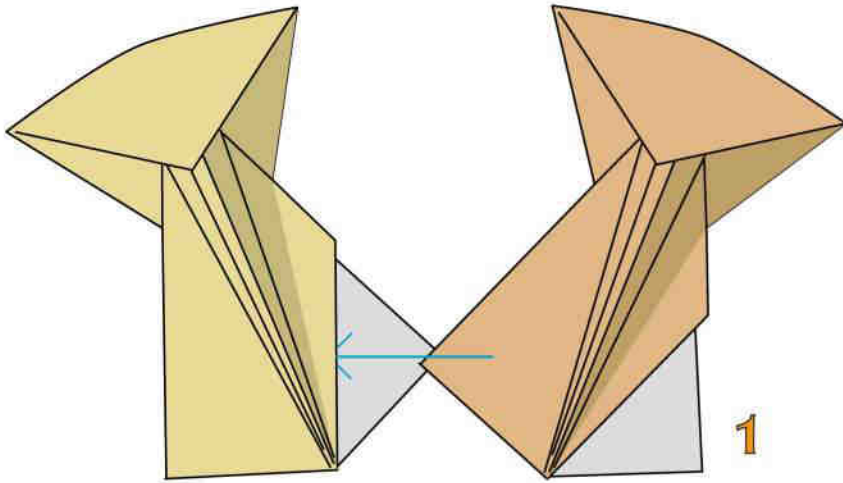

Inserite un modulo nell'altro

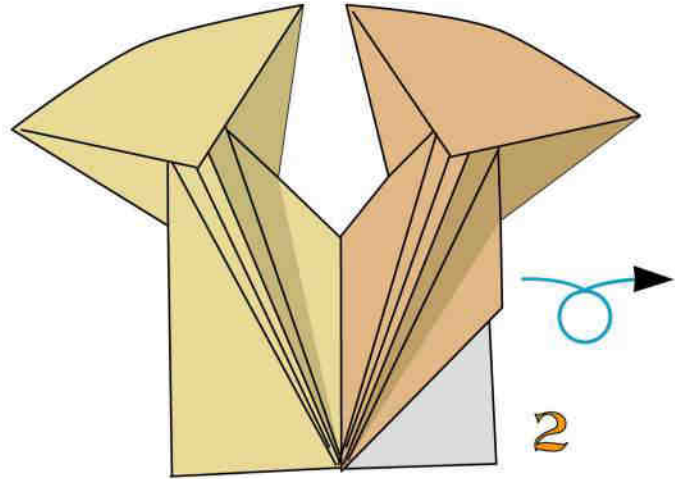

Ribaltate

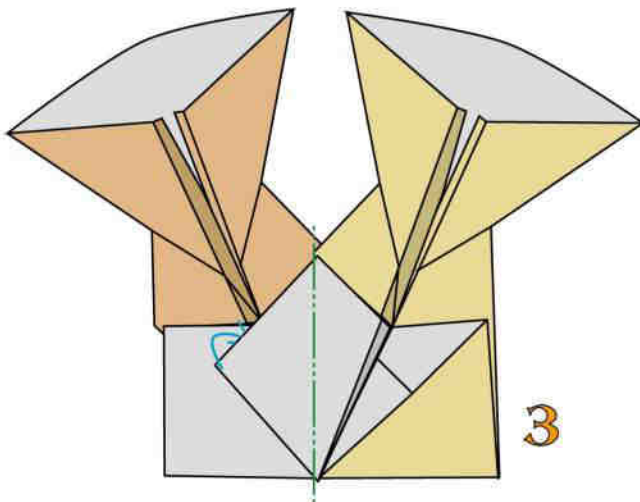

Con una piega a monte intascate e bloccate l'unione

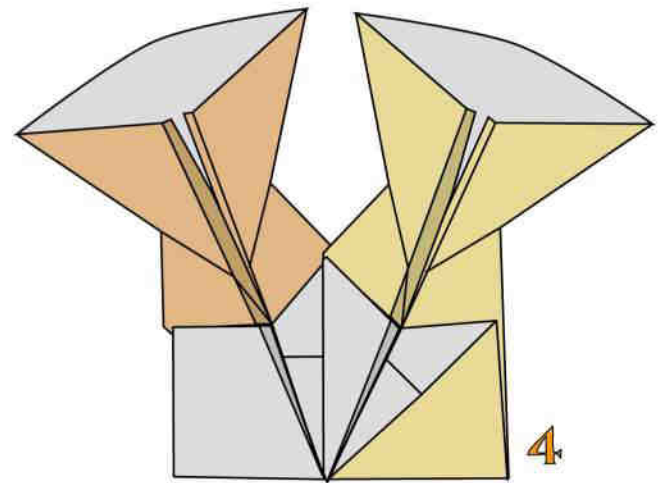

Unione completata

TASSELLAZIONE "A" MODULARE CILINDRICA TRAFORATA

Franco Pavarin 24

Si costruisce unendo moduli per
nastro "A" e moduli di collegamento "A".
Adoperate carta monocolora di medio
peso delle dimensioni di cm 10x10



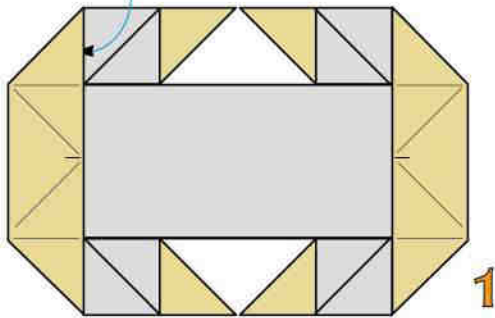
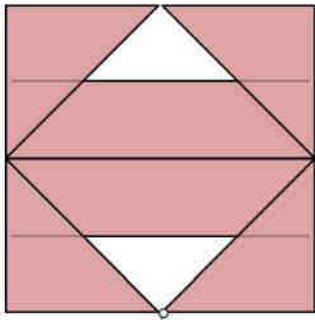

Intascate i 2 vertici sovrapposti del modulo di collegamento entro un modulo "A"

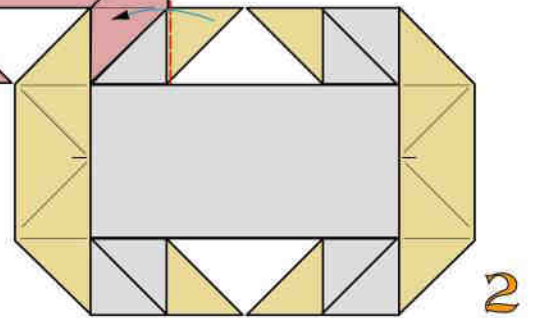
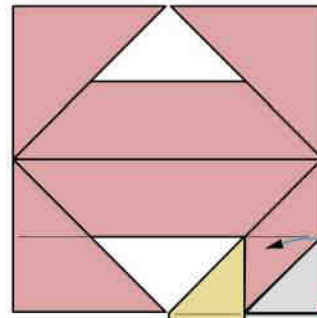

Ripiegate a valle nel modulo "A"

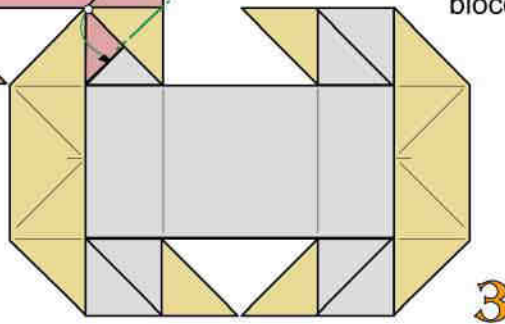
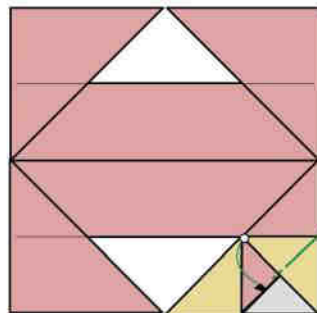

Mediante 1 piega a monte intascate bloccando l'unione

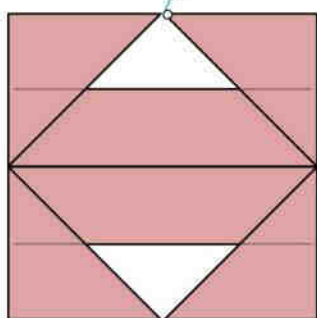
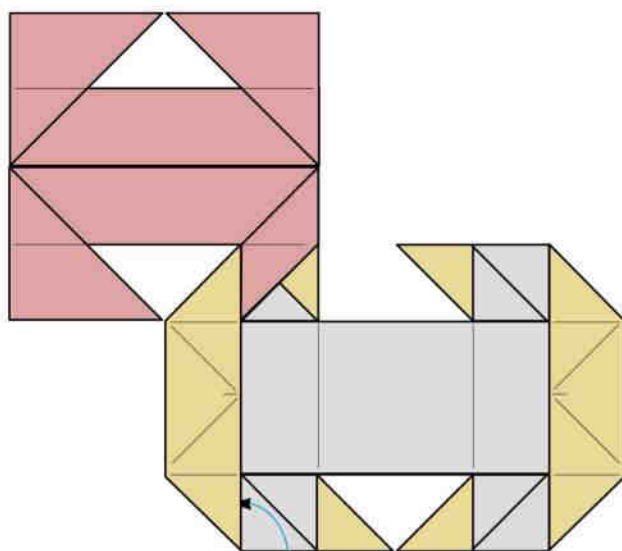

4

Nello stesso modo unite un altro modulo di collegamento

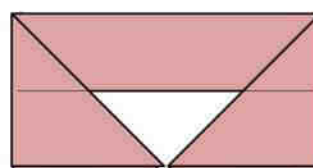

Per ottenere un modulo di bordo piegate a metà un modulo di collegamento

TASSELLAZIONE 'B' MODULARE COMPATTA

Franco Pavarin 24

Per costruire questa tassellazione servono fogli monocolori di medio peso e delle dimensioni di cm 10x10

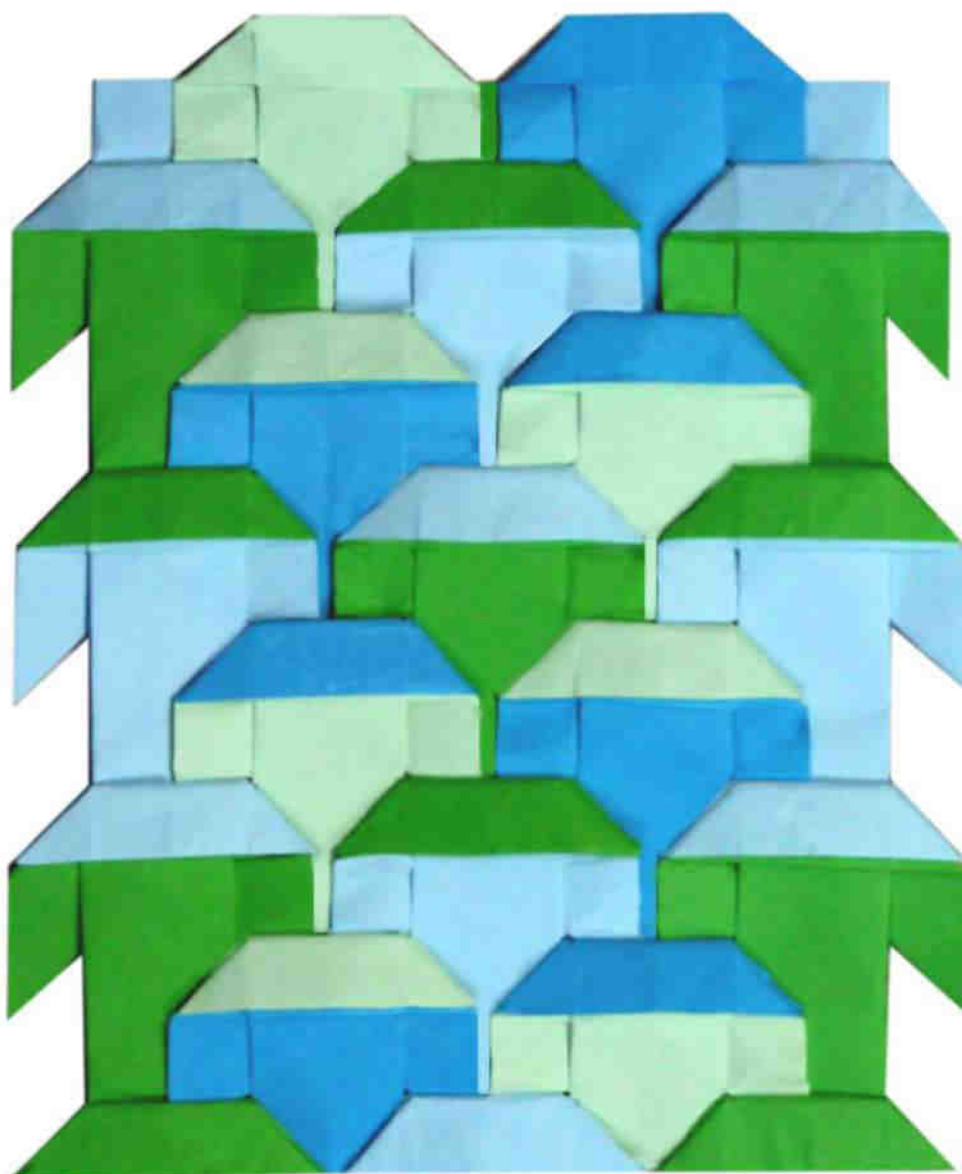

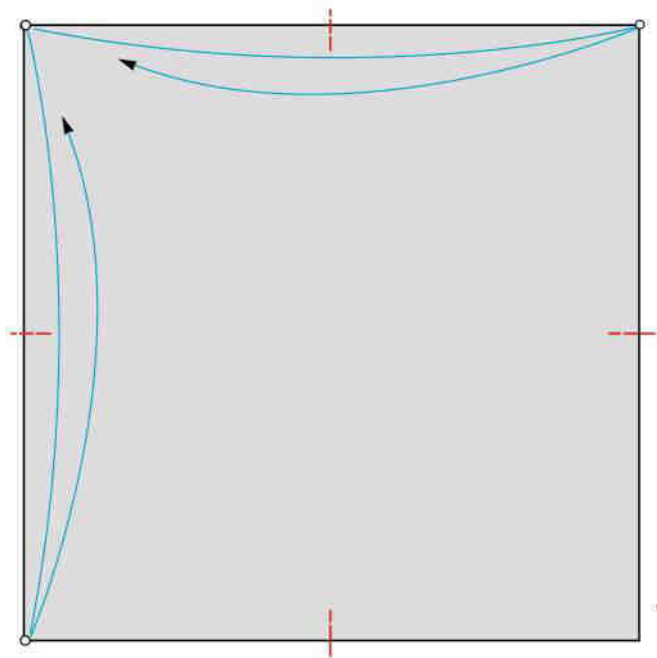

4 piccole pieghe a valle

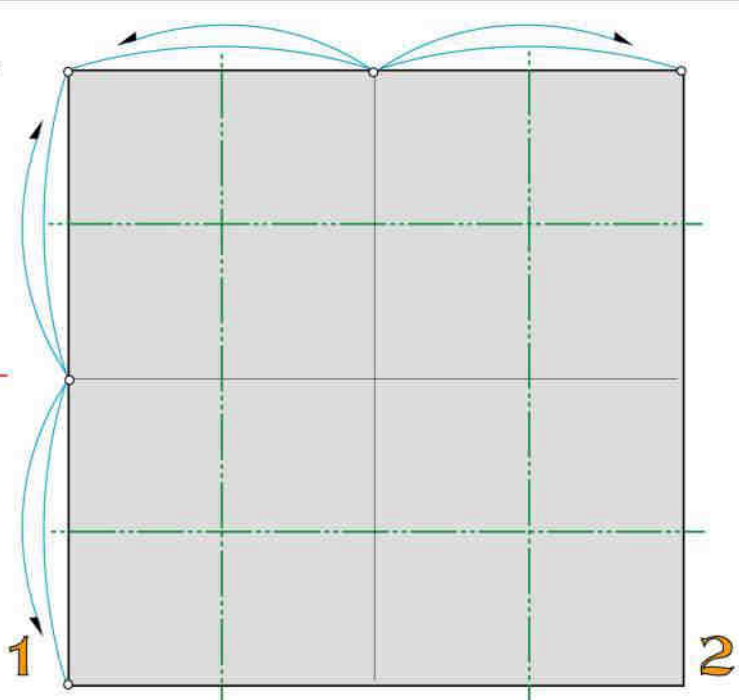

4 pieghe a monte

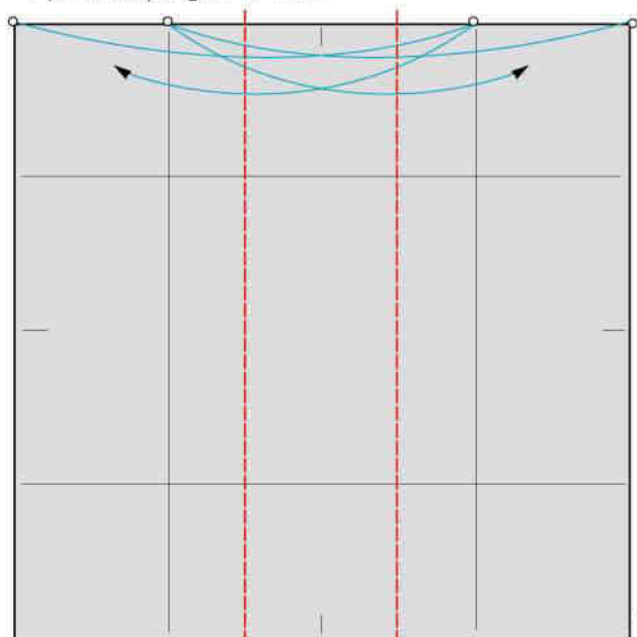

3

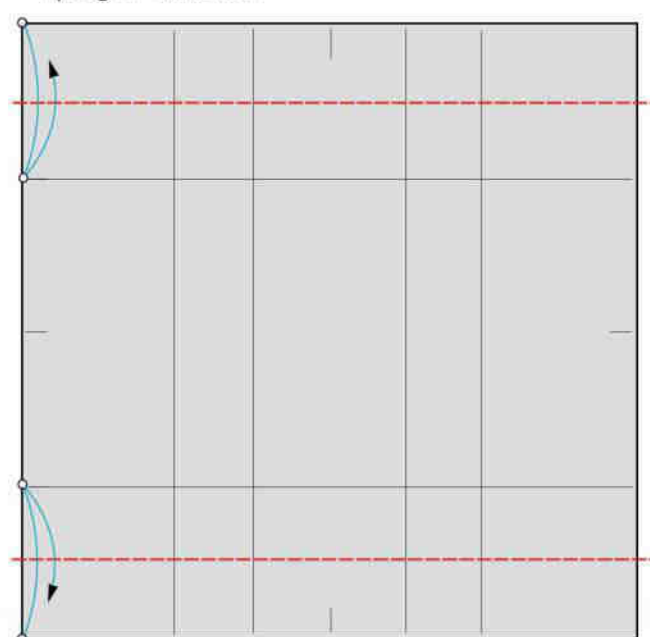

4

2 pieghe a valle

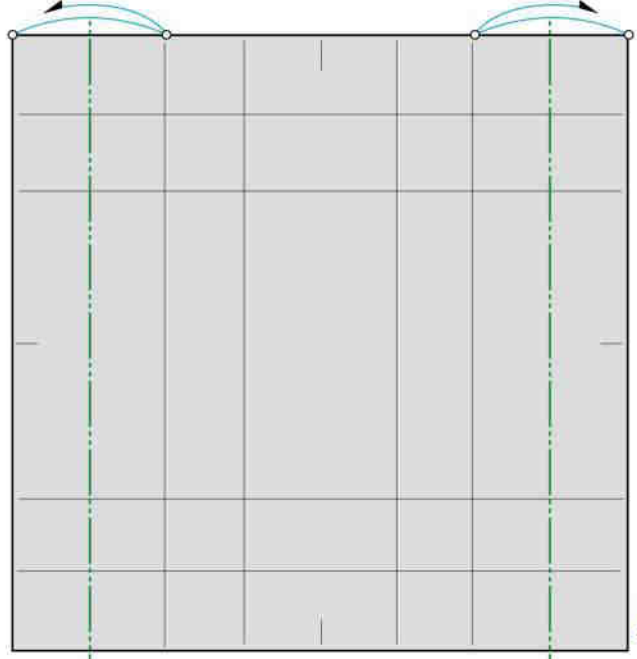

5

2 pieghe a valle

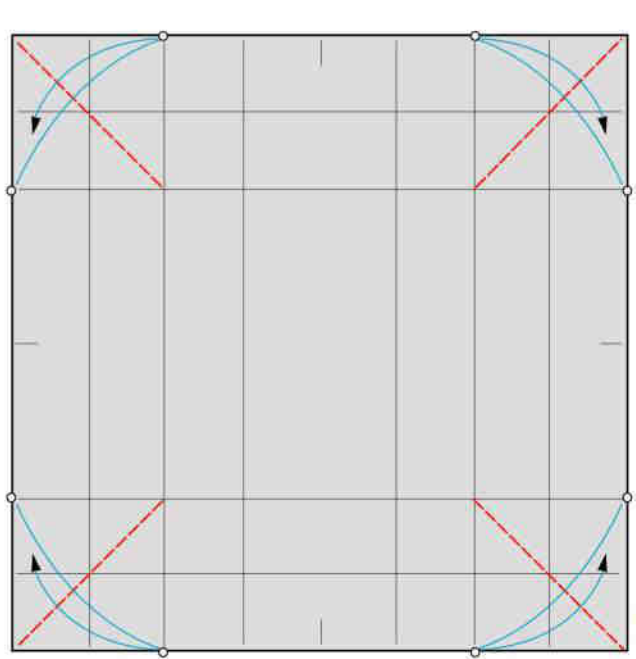

6

2 pieghe a monte

4 pieghe diagonali a valle

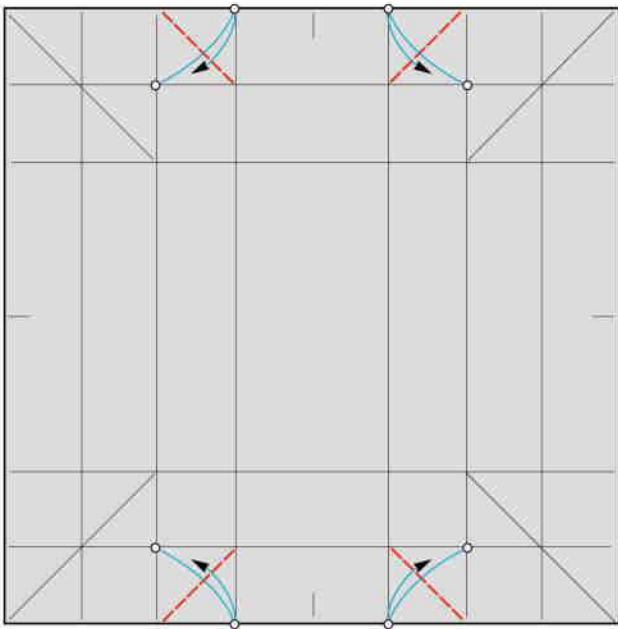

7

4 pieghe diagonali a valle

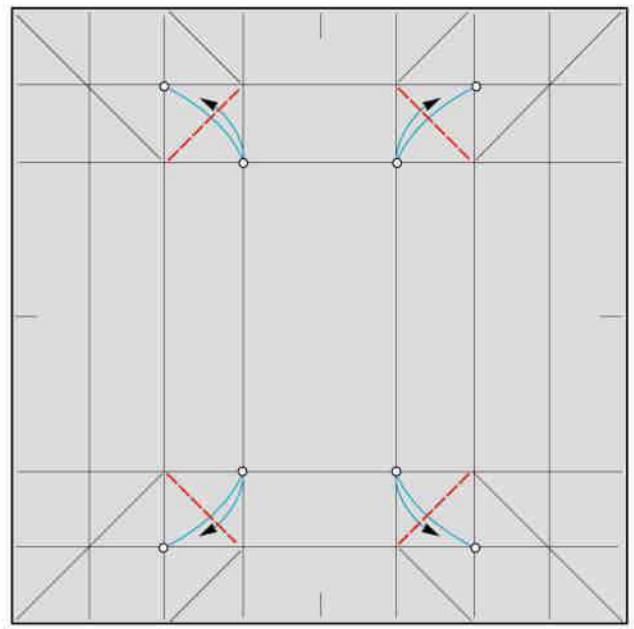

8

4 pieghe diagonali a valle e ribaltate

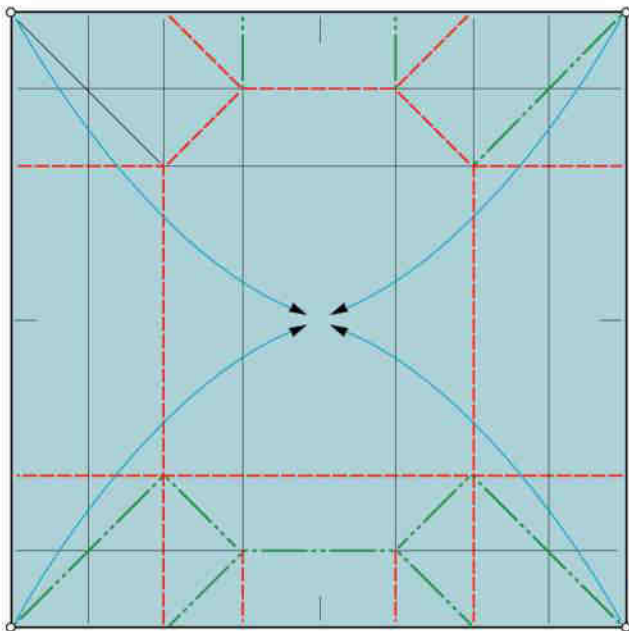

9

Ripiegate a valle e a monte

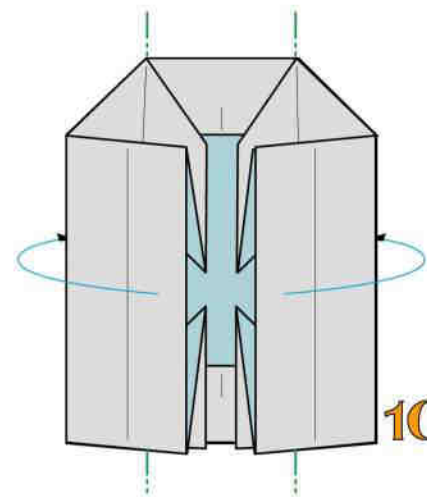

10

Aprite

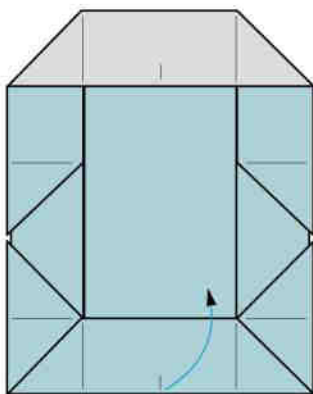

11

Aprite

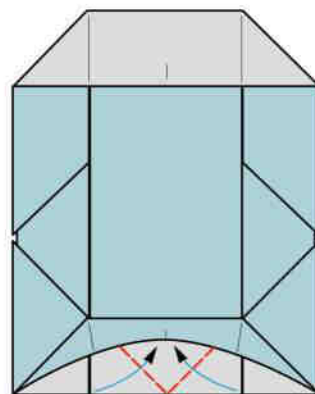

12

2 pieghe bisettrici a valle e ribaltate

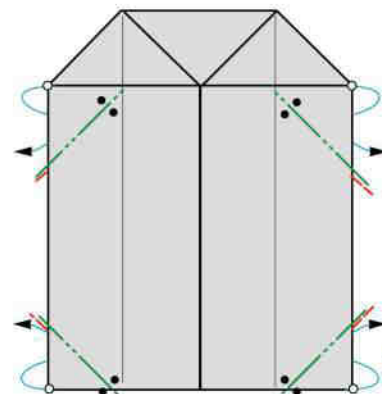

13

4 pieghe rovesce interne e ribaltate

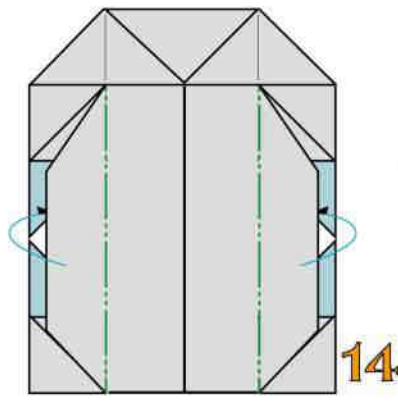

14
Mediante 2 pieghe a monte
intascate le 2 superfici

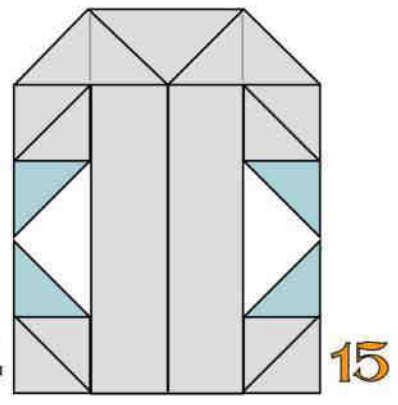

15
Ribaltate

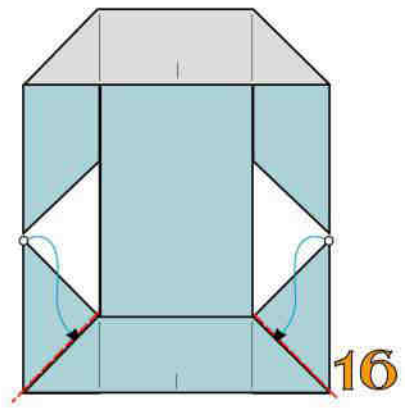

16
2 pieghe a valle e intascate

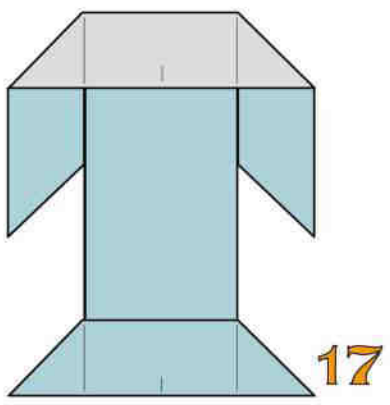

17
Modulo tassellazione
"B" ultimato

UNIONE DEI MODULI

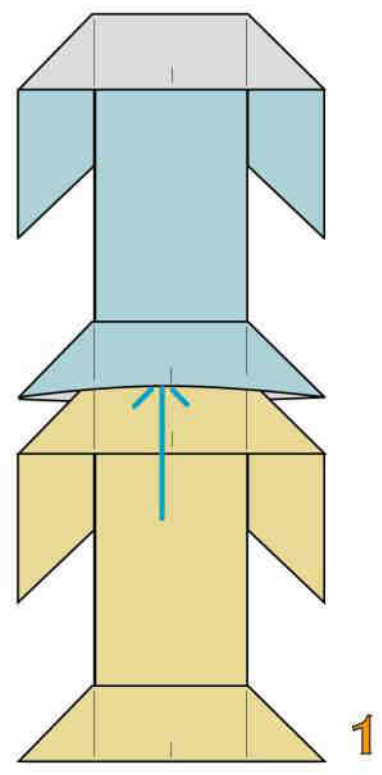

1
Inserite un modulo nell'altro

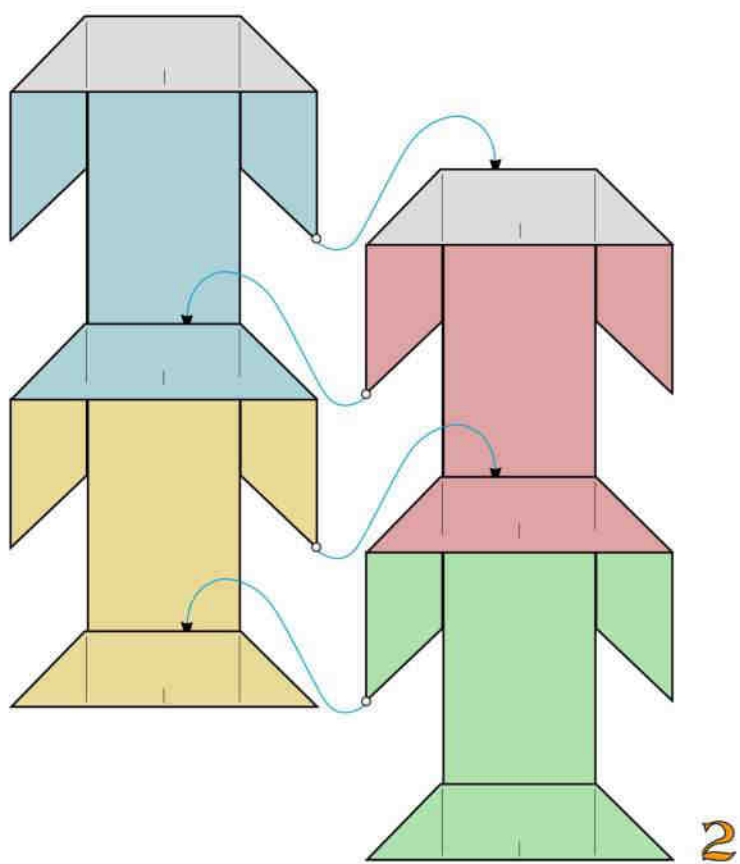

Incastrate vicendevolmente un modulo nell'altro

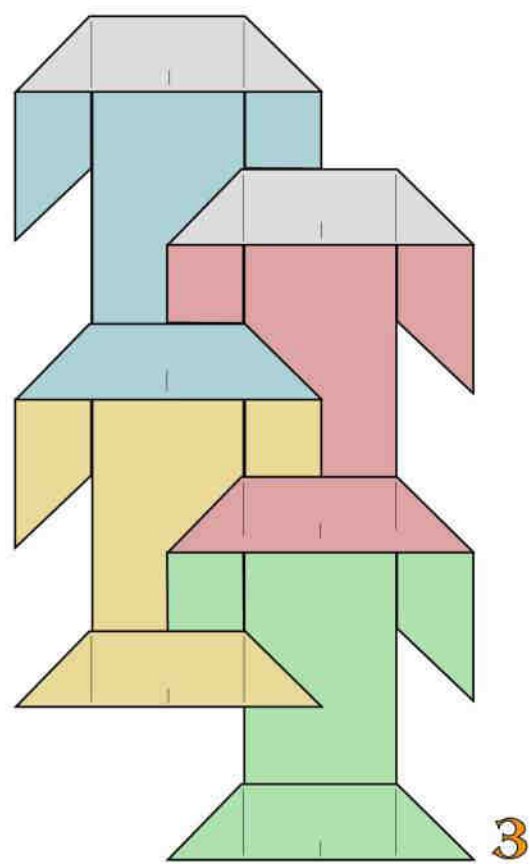

Moduli uniti

TASSELLAZIONE "C" MODULARE COMPATTA

Franco Pavarin 24

Per la costruzione sono necessari 2 tipi di moduli, da realizzare con carta monocolore o bicolore leggera delle dimensioni di cm 7,5x7,5

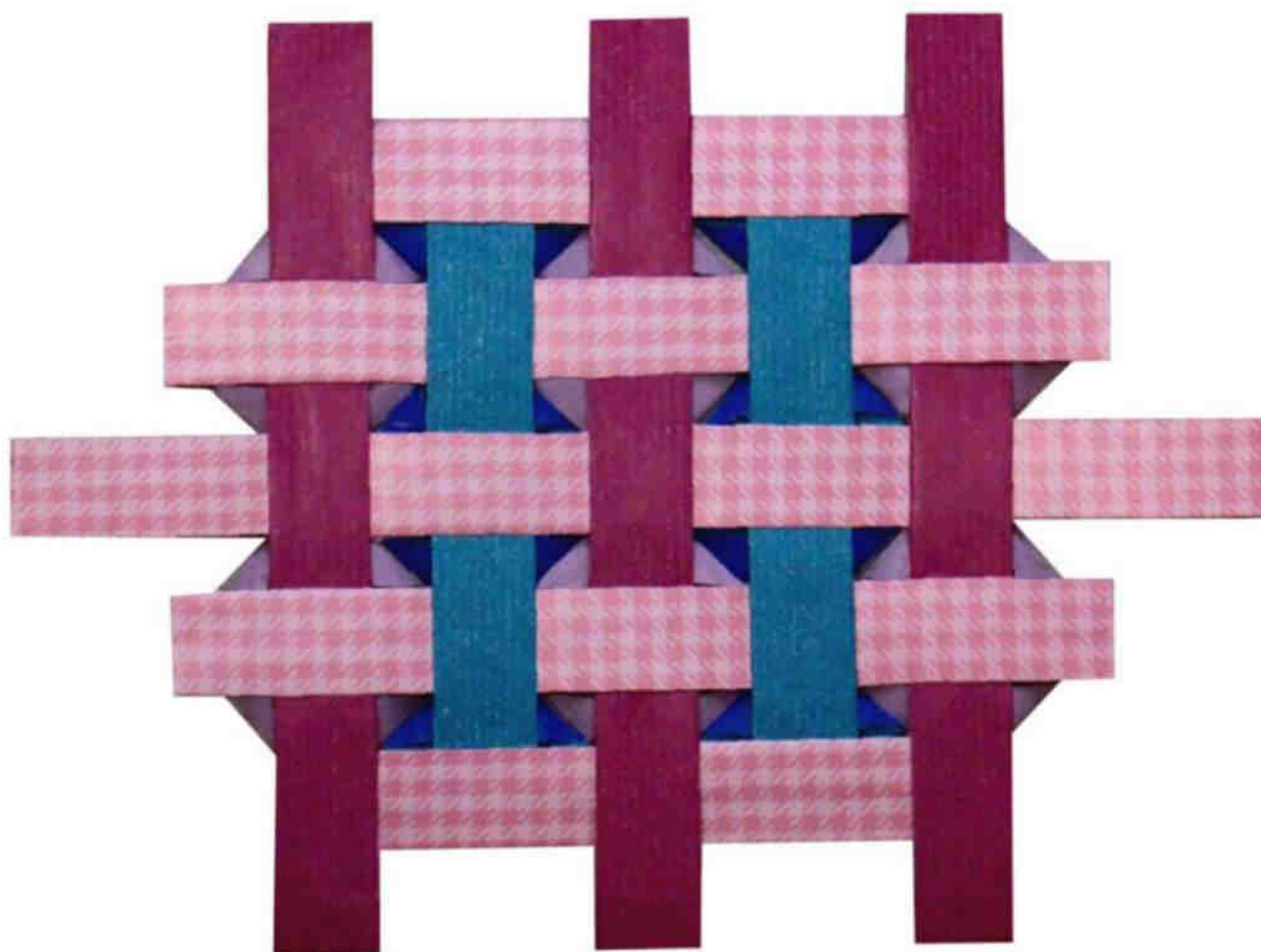

MODULO PER TASSELLAZIONI "C" MODIFICATO

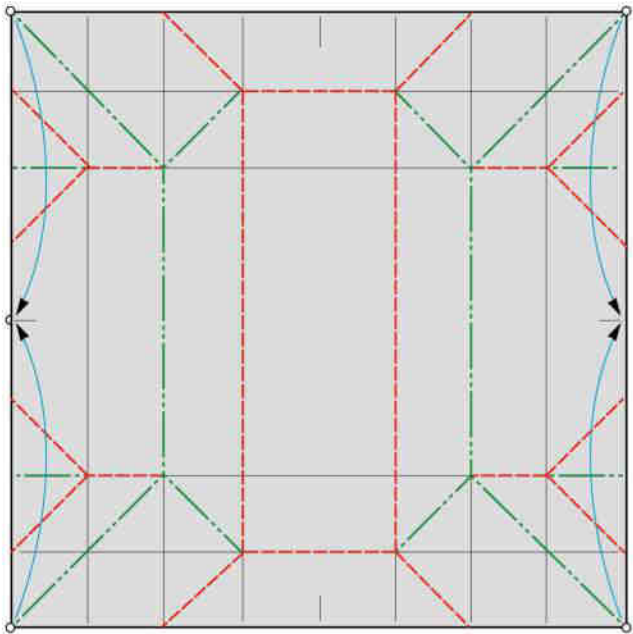

Si parte dal modulo per nastri "A" aperto. Ripiegate a valle e a monte

Modulo per tassellazioni "C" modificato ultimato

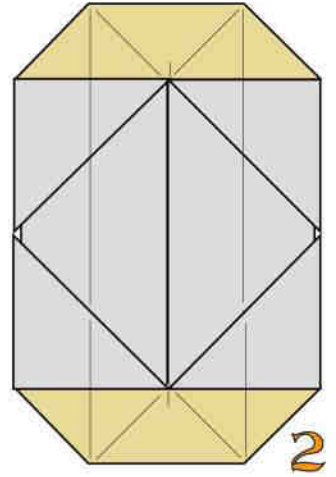

MODULO PER TASSELLAZIONI "C"

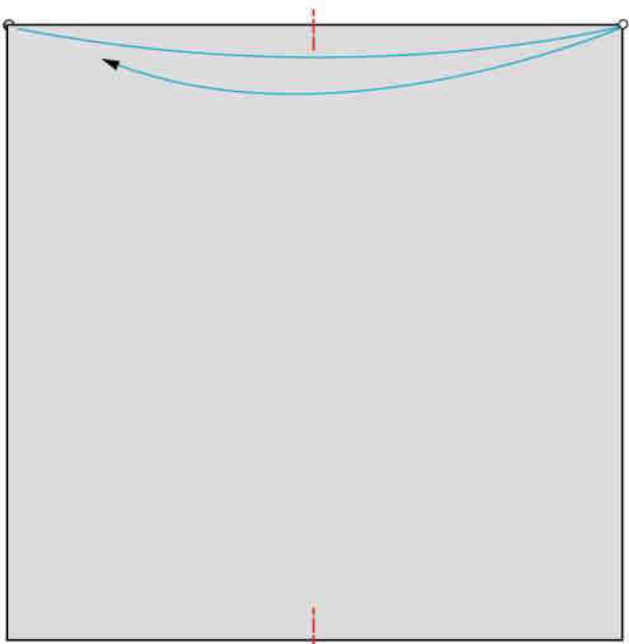

2 piccole pieghe a valle

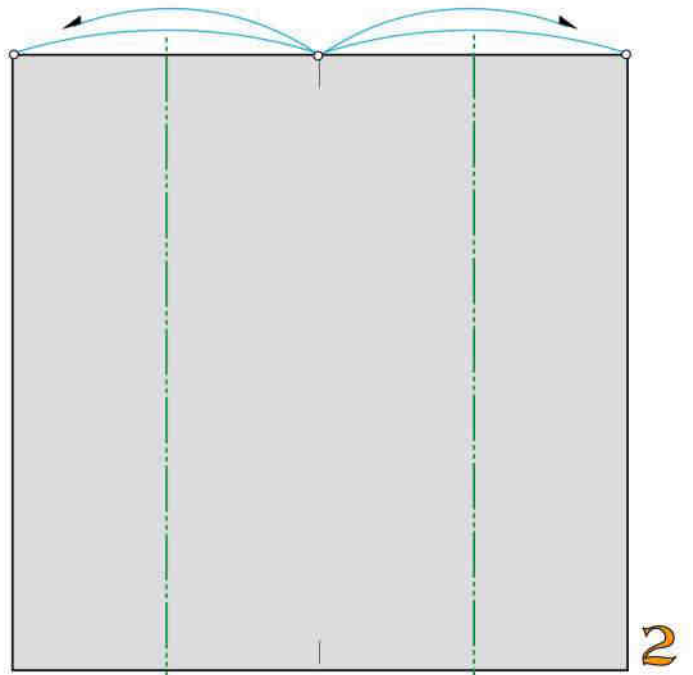

2 pieghe a monte

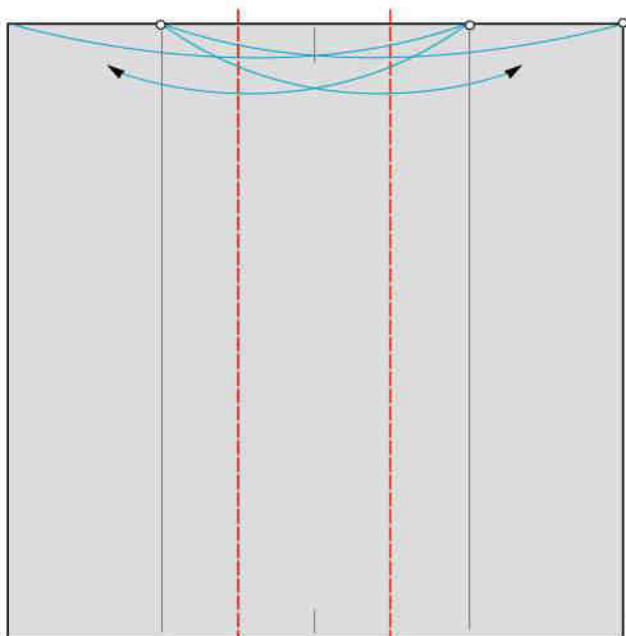

3

2 pieghe a valle

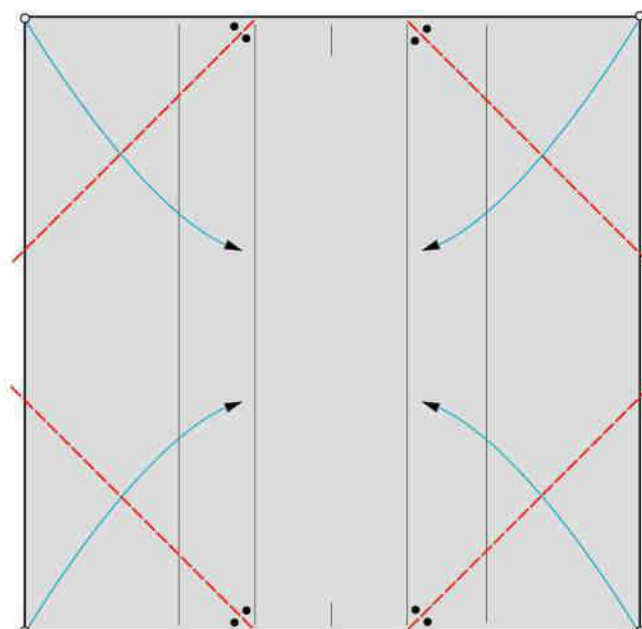

4

4 pieghe bisettrici a valle

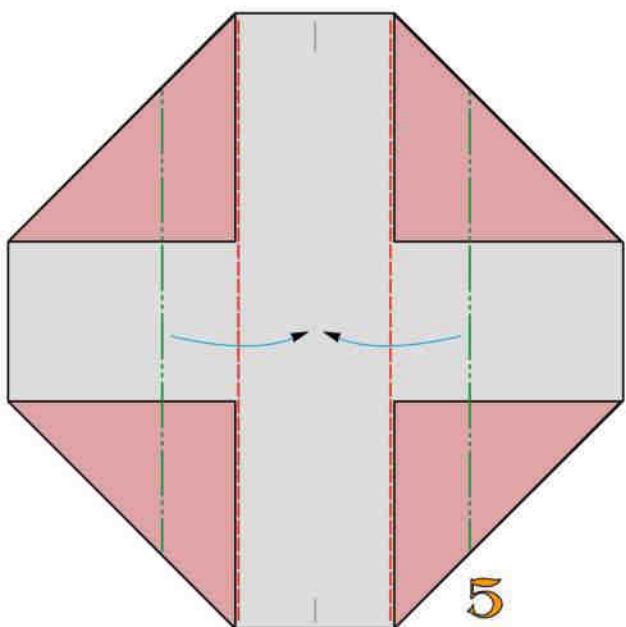

5

Ripiegate a valle e a monte

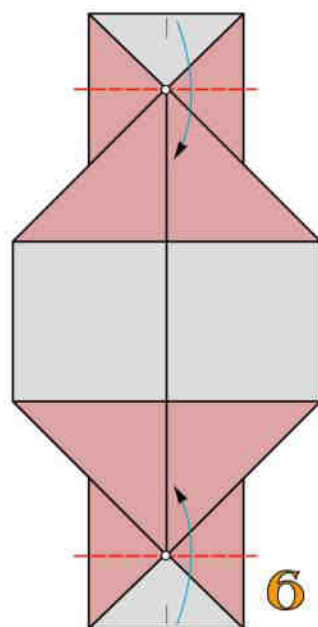

6

2 pieghe a valle

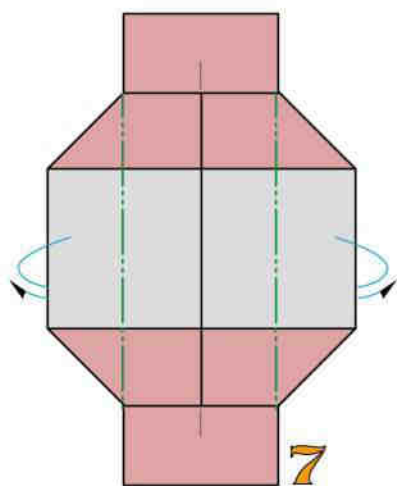

7

2 pieghe a monte

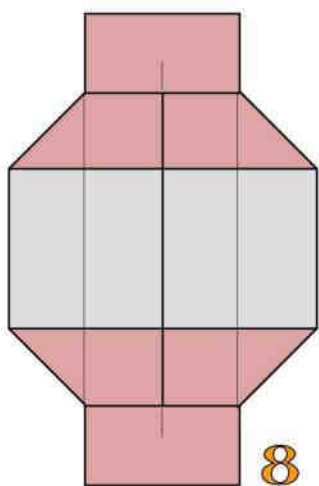

8

Modulo per tassellazioni
"C" ultimato



UNIONE DEI MODULI

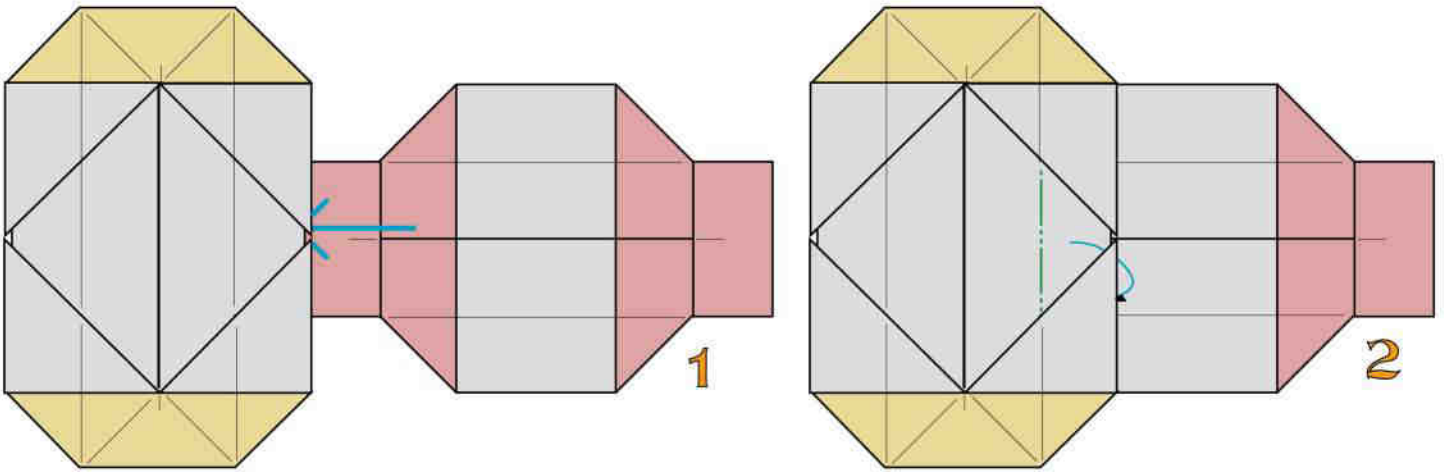

Inserite un modulo "C" in un modulo "C" modificato

Ripiegando a monte intascate e bloccate l'unione

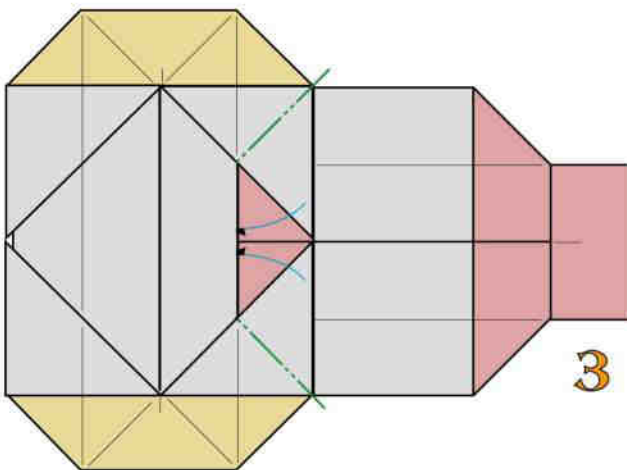

Intascate le 2 appendici triangolari

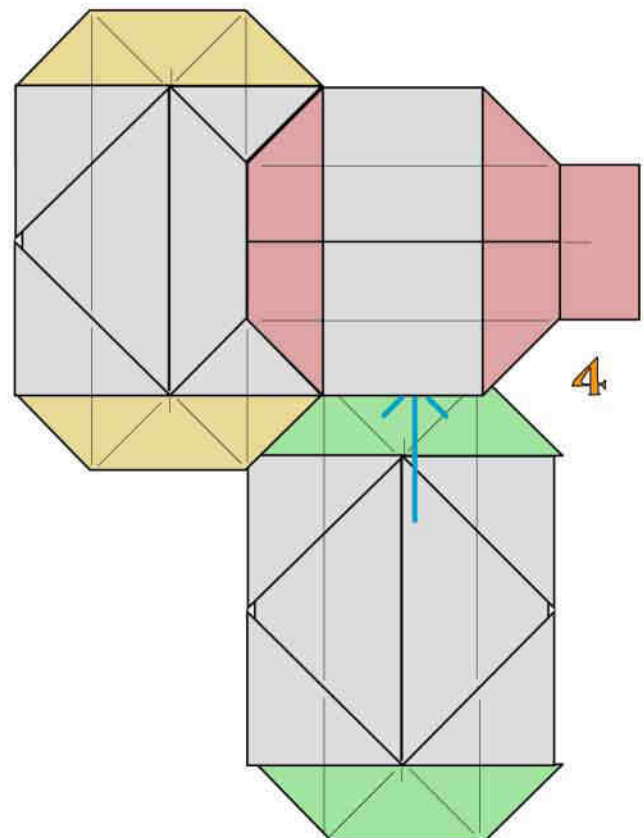

Inserite un nuovo modulo "C" modificato in un modulo "C"

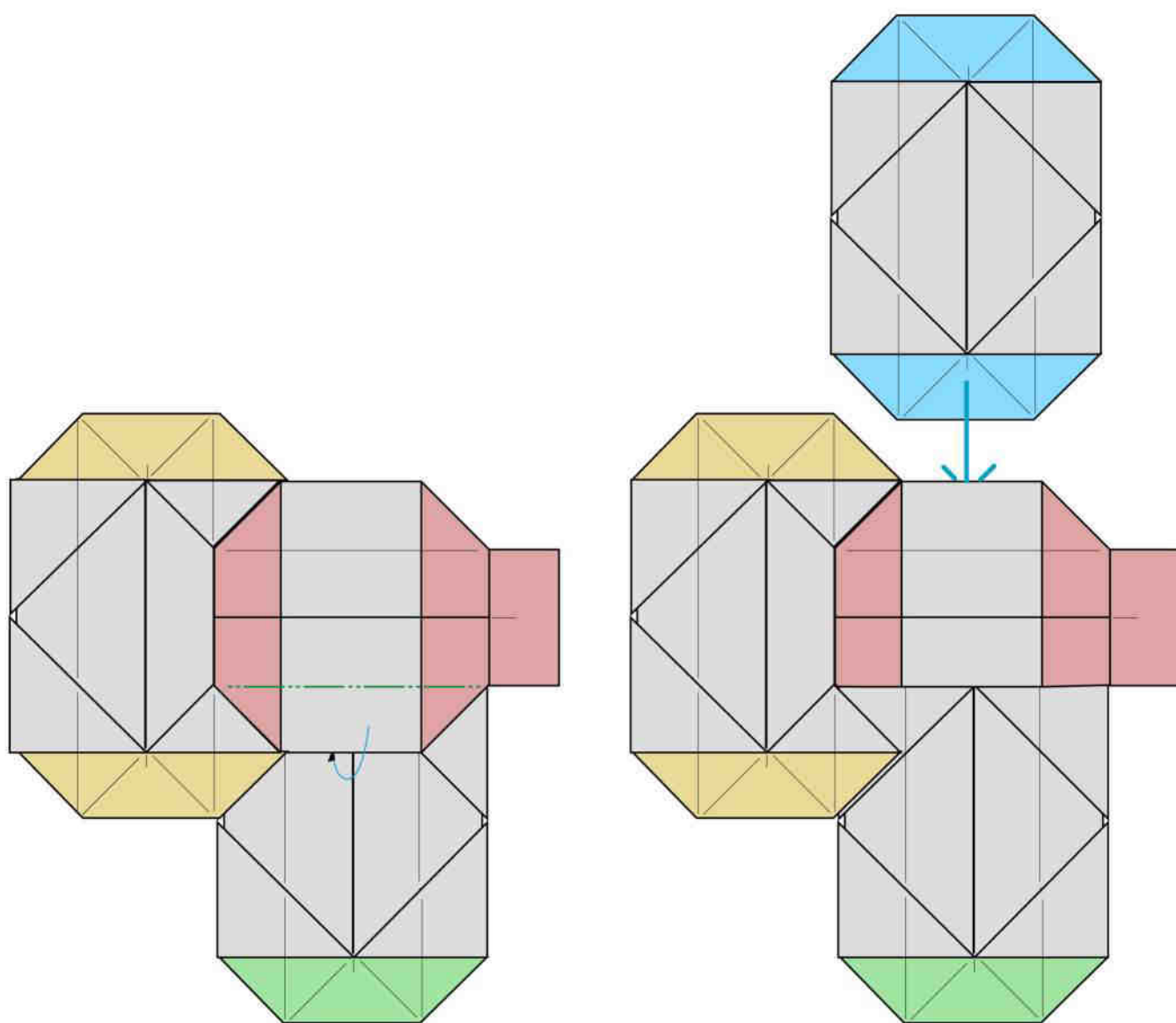

Ripiegando a monte intascate e bloccate l'unione Inserite un nuovo modulo "C" modificato in un modulo "C"

TASSELLAZIONE "A" MODULARE TRAFORATA A TORRE

varin 24

Si costruisce unendo 3 tipi differenti di moduli per nastro "A" modificati. Adoperate carta monocoloro di medio peso delle dimensioni di cm 10x10



MODULO PER NASTRO "A" MODIFICATO 1

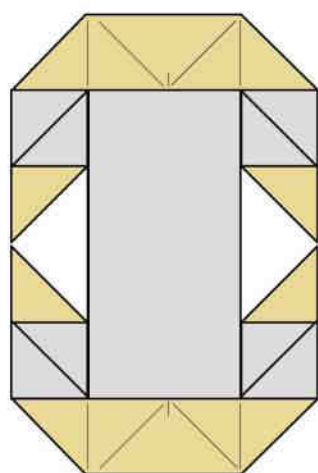

Modulo per nastro "A". Ribaltate

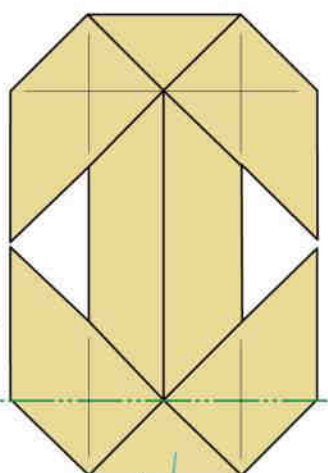

1 piega a monte

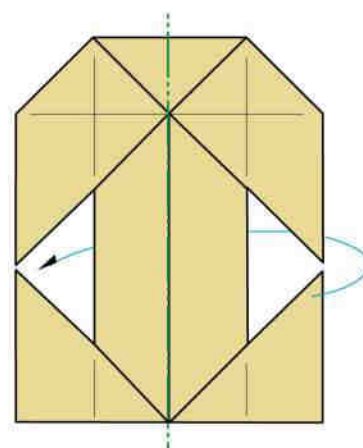

1 piega a monte

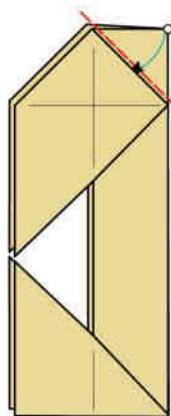

1 piega a valle e intascate

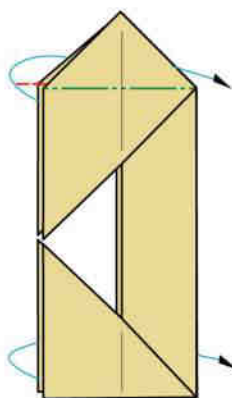

Ripiegando a monte modellate 3D

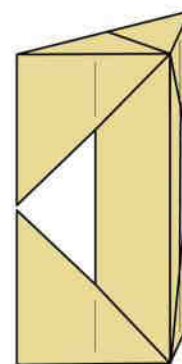

Modulo per nastro "A" modificato 1 ultimato

MODULO PER NASTRO "A" MODIFICATO 2

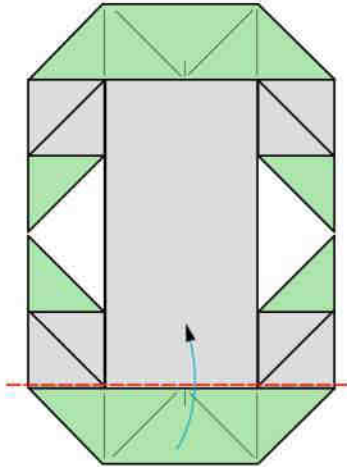

Modulo per nastro "A". 1 piega a valle

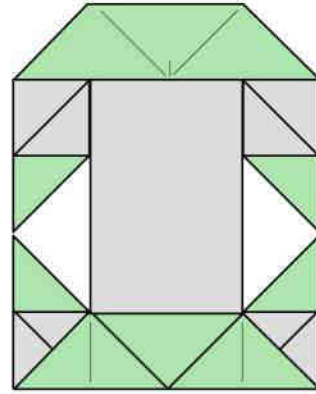

Modulo per nastro "A" modificato 2 ultimato

MODULO PER NASTRO "A" MODIFICATO 3

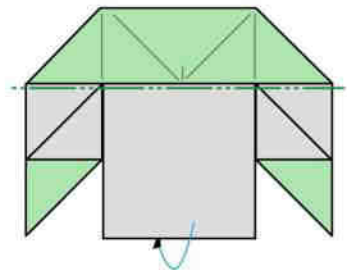

Semimodulo per nastro "A". 1 piega a monte

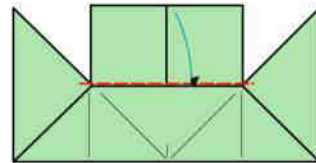

1 piega a valle e intascate

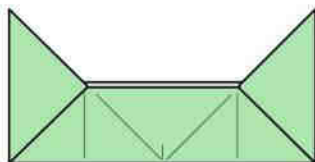

Modulo per nastro "A" modificato 3 ultimato

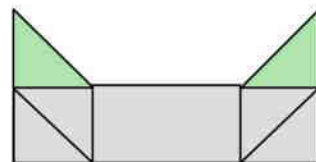

UNIONE DEI MODULI

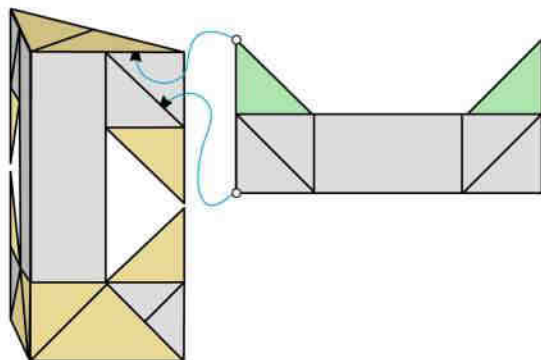

Inserite un modulo modificato 3 in un modulo modificato 1

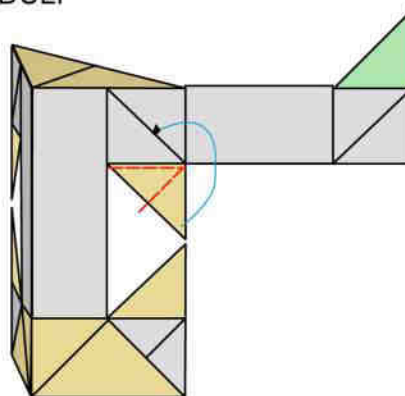

Mediante 2 pieghe a valle intacando bloccate l'unione

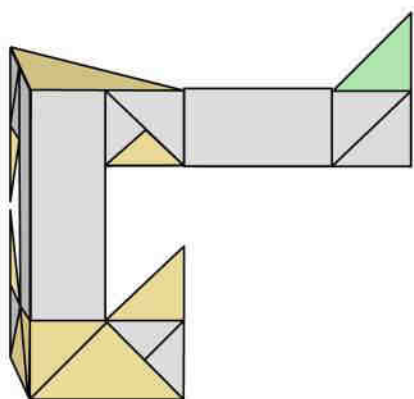

Unione di 2 moduli del bordo superiore del modello ultimata

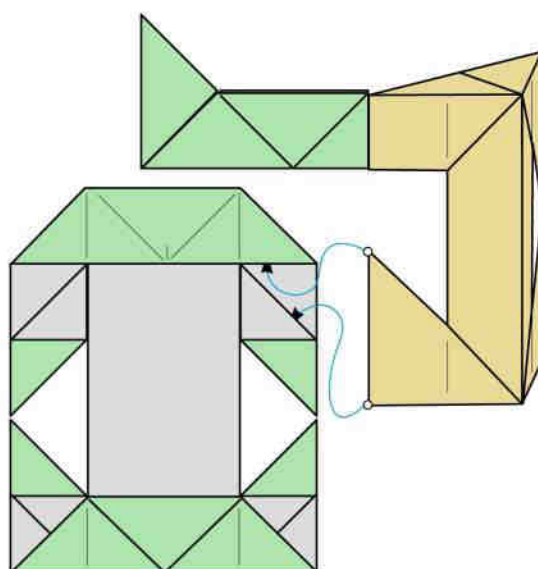

Inserite il modulo modificato 3 in un modulo modificato 2

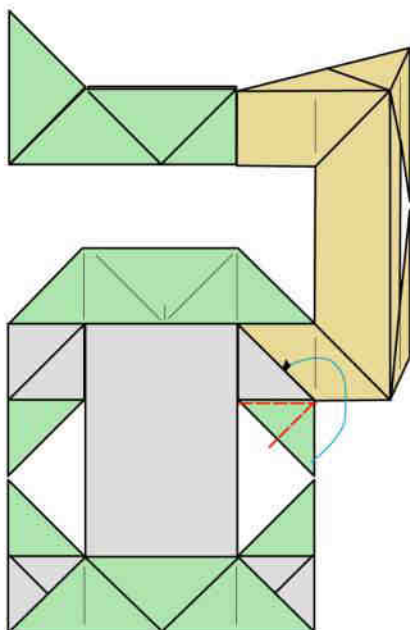

Mediante 2 pieghe a valle intacando bloccate l'unione

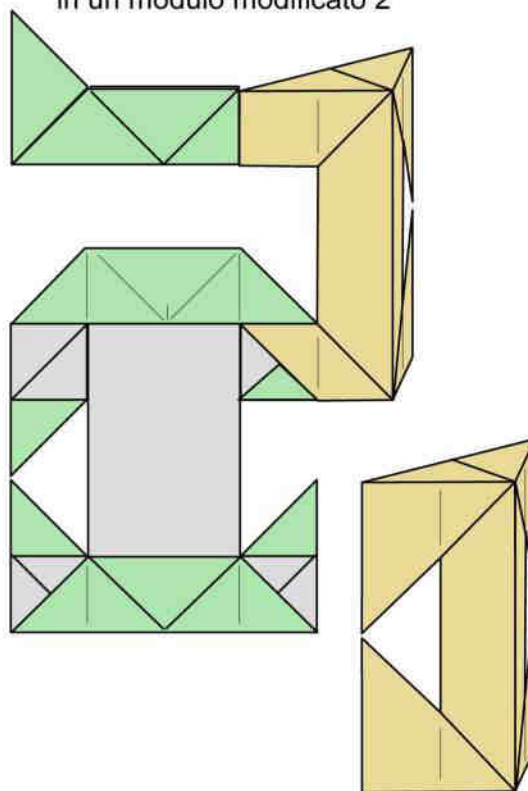

Aggiungete 1 modulo modificato 1 e bloccatelo nel solito modo

TASSELLAZIONE "B" MODULARE TRAFORATA A TORRE

Franco Pavarin 24

Derivato dalla torre "A", si costruisce unendo moduli composti e moduli per nastro "A" modificati.

Adoperate carta monocoloro di medio peso delle dimensioni di cm 10x10

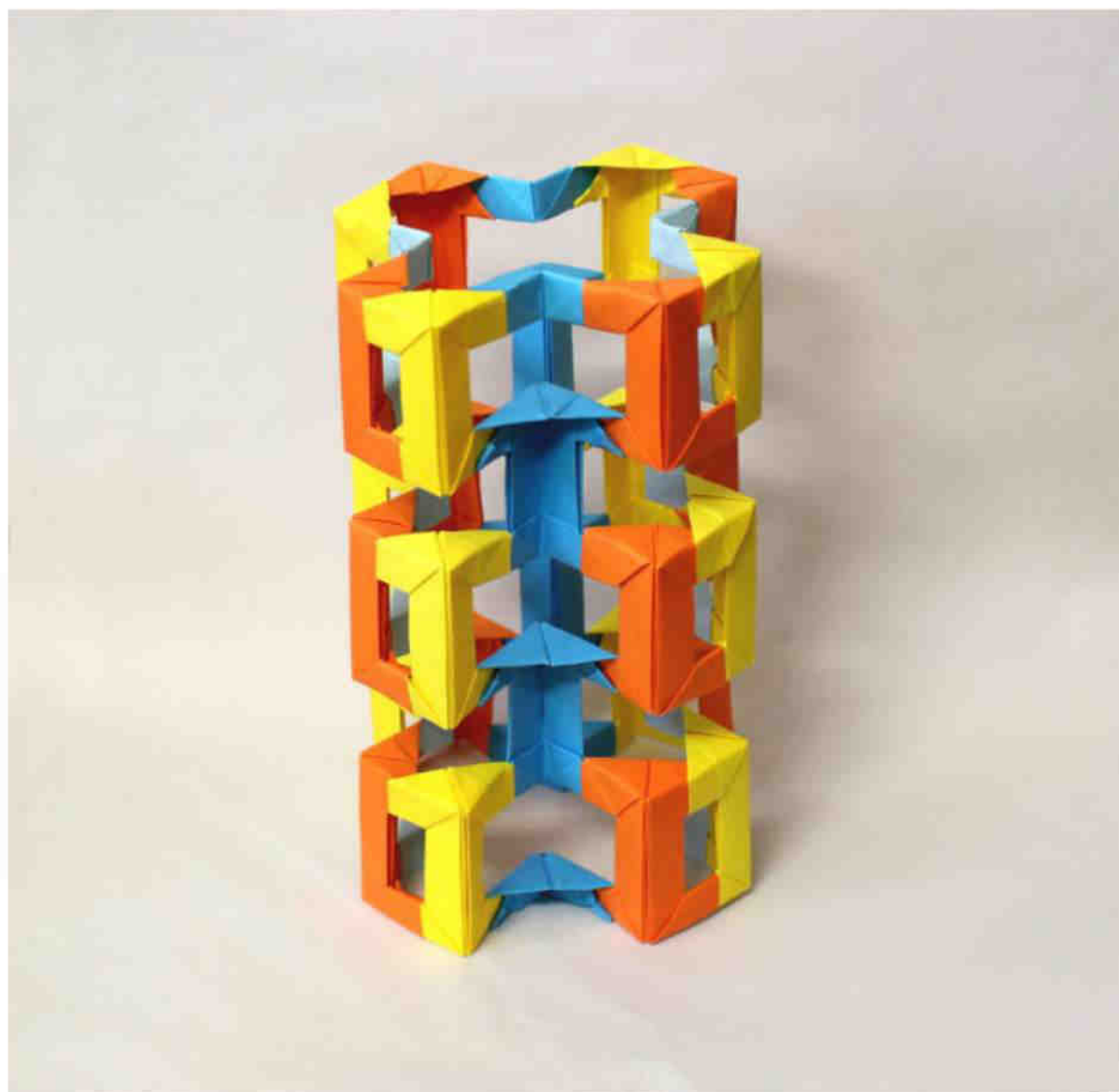

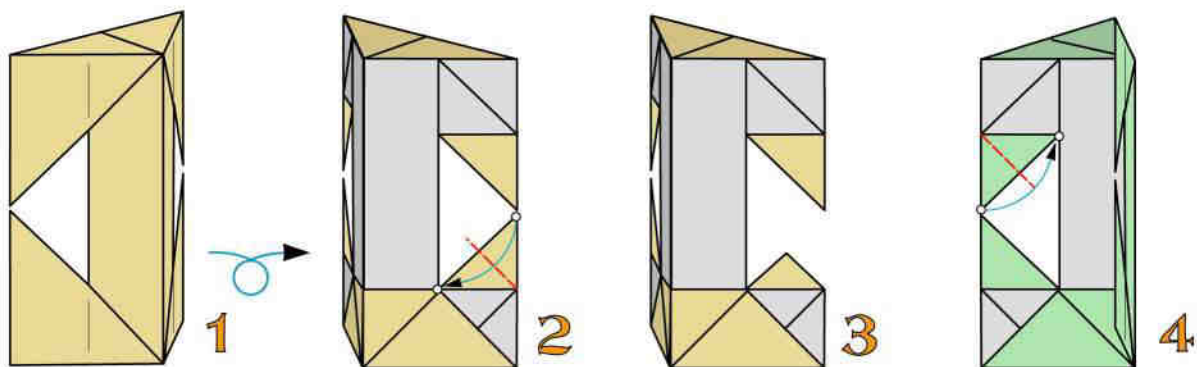

1
 Primo modulo per torre "B"
 Partite dalla torre "A".
 Modulo per nastro "A"
 modificato. Ribaltate

2
 1 piega a valle
 sul triangolo inferiore

3
 Primo modulo per
 torre "B" ultimato

4
 Secondo modulo
 per torre "B".
 1 piega a valle
 sul triangolo
 superiore

UNIONE DEI 2 MODULI

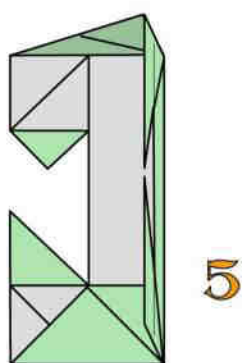

5
 Secondo modulo per
 torre "B" ultimato

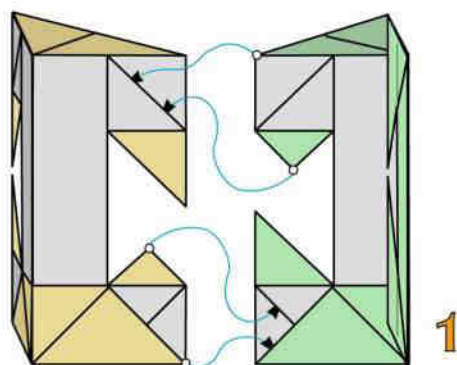

1
 Inserite vicendevolmente un modulo nell'altro

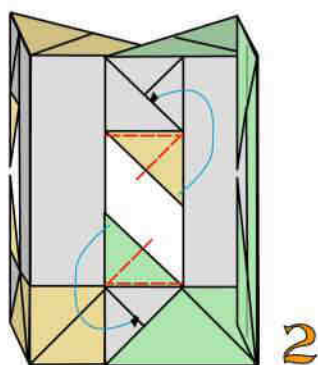

2
 Mediante 4 pieghe a valle
 bloccate l'unione

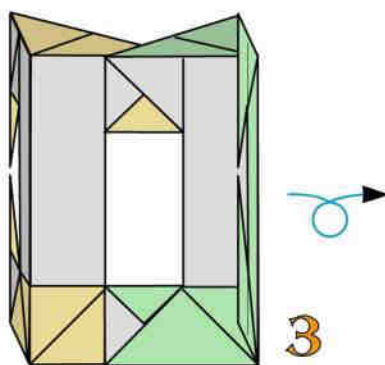

3
 Modulo composto ultimato

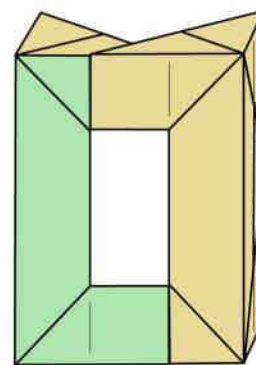

UNIONE DL MODULO COMPOSTO CON UN MODULO PER NASTRO "A" MODIFICATO

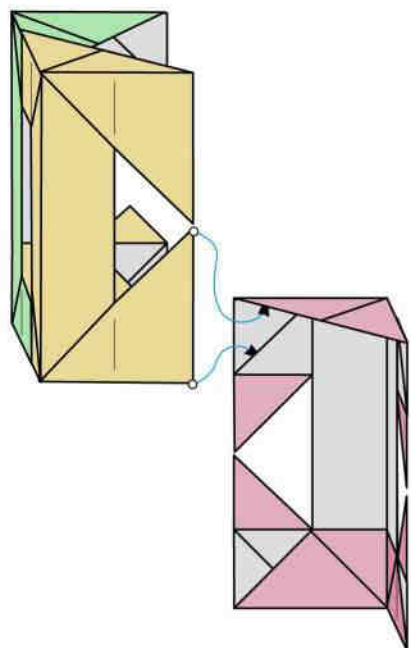

Inserite il modulo composto in un modulo per nastro "A" modificato

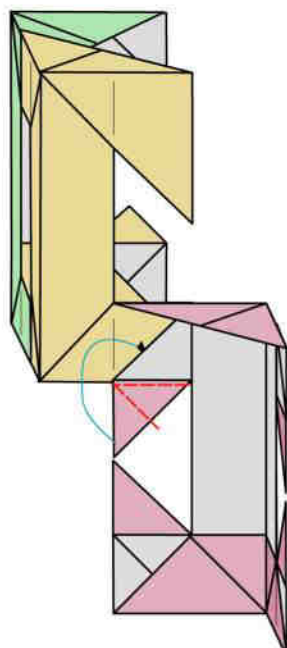

Mediante 4 pieghe a valle bloccate l'unione

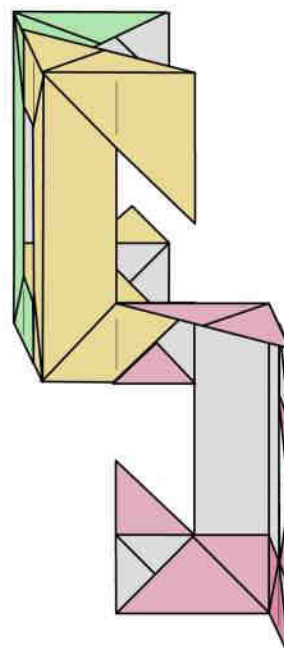

Unione completata

MODULI DI BORDO

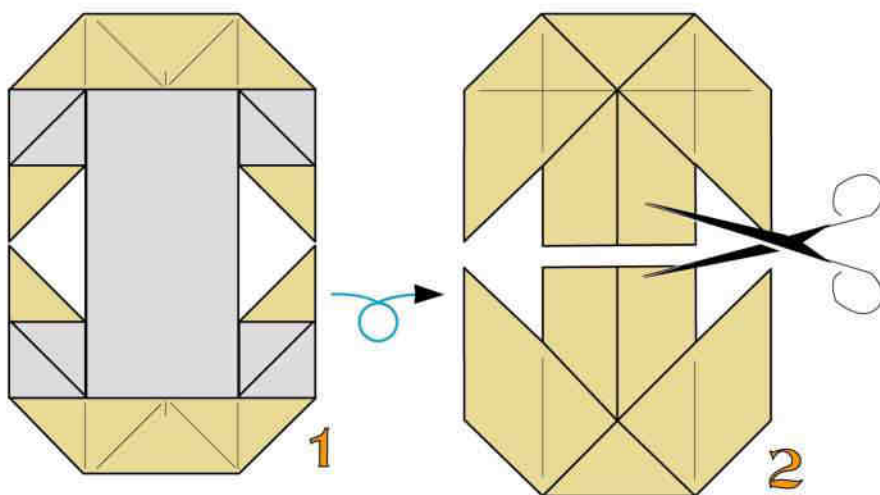

Ribaltate e dividete a metà un modulo per nastro "A"

MODULO DI BORDO DEL BASAMENTO

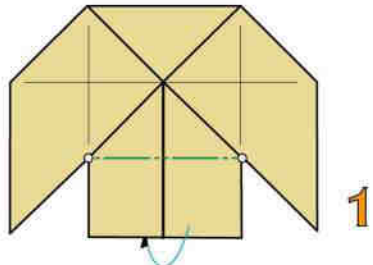

1 piega a monte

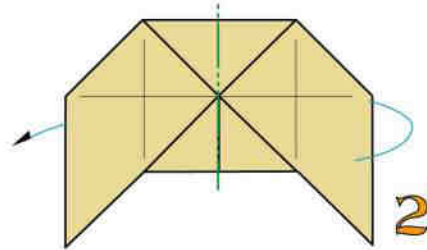

1 piega a monte

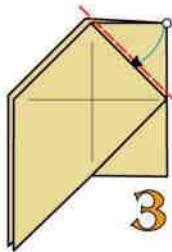

1 piega a valle e intascate

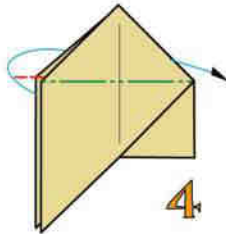

Ripiegando a monte modellate 3D

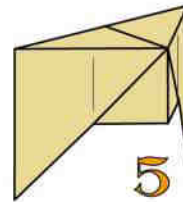

Modulo basamento ultimato

MODULO DI BORDO DELLA SOMMITÀ

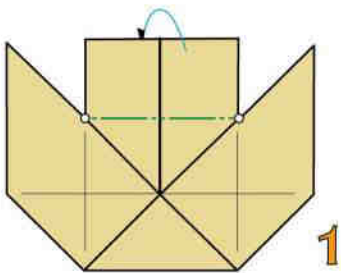

1 piega a monte

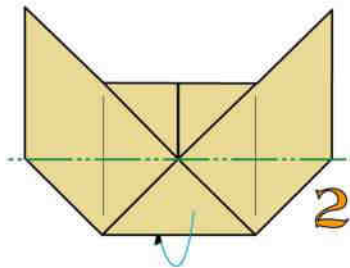

1 piega a monte

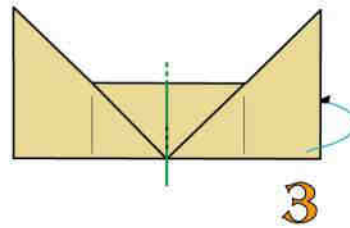

1 piega a monte

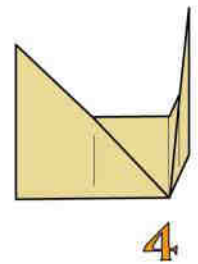

Modulo sommità ultimato

PUBBLICAZIONI DI FRANCO PAVARIN

Aerei , jet ed astronavi di carta volanti	IL CASTELLO	1986
Origami animati	"	1987
Origami maschere animate	"	1988
Decorazioni modulari con origami modulati	"	1989
Origami motoscafi navi barche e velieri	"	1990
Origami scatole e contenitori	"	1990
Pieghe forme e colori	"	1994
Aerei e navi di carta	FABBRI	1996
Fold and fly Paper airplanes	STERLING PUBLISHING	1998
Manuale rapido di aerei di carta volanti	FABBRI	2000
Aerei di carta 17 modelli volanti inediti	IL CASTELLO	2001
Aviones voladores	TUTOR S.A.	2003
17 modelos ineditos de aviones voladores	"	2004
Naves voladoras	"	2006
Quaderni Quadrato magico n.20 e 48	CDO	
Maschere, elmi e copricapi	web	2010
Maschere trasformabili	web	2011
21 nuovi aerei origami volanti	web	2014
Maschere origami 3D volume 1	web	2014
Maschere origami 3D volume 2	web	2015
Legorigami 1 -Q.Quadrato Magico n.56	CDO	2015
Composizione modulare 1	web	2016
Manuale dell'architetto origamista	web	2016
13 moduli origami aggregabili	web	2017
Alfabeti origami	web	2018
21 Elmi e strani copricapi origami	web	2019
Animalletti semplici origami	web	2020
Origami per giocare	web	2020
30 nuovi origami volanti	web	2021
Contenitori 1	web	2021
Contenitori 2	web	2021
Contenitori 3	web	2022
Contenitori 4	web	2022
Volti scolpiti origami 1	web	2018
Volti scolpiti origami 2	web	2019
Contenitori 5	web	2022

Manuale di arredamento	web	2022
Composizione modulare 2	web	2023
Castelli e fortezze componibili	web	2023
Contenitori origami 6	web	2023
Navi, barche e velieri	web	2023
Composizione modulare 3	web	2023

