

Fox Cub

子狐

難易度 ★★★★★

折り紙用紙

15cm角 / 1枚



他の作品で作った狐の顔を流用して可愛い子狐としてまとめた作品です。65の段折りで頭の角度を変化させることができます。

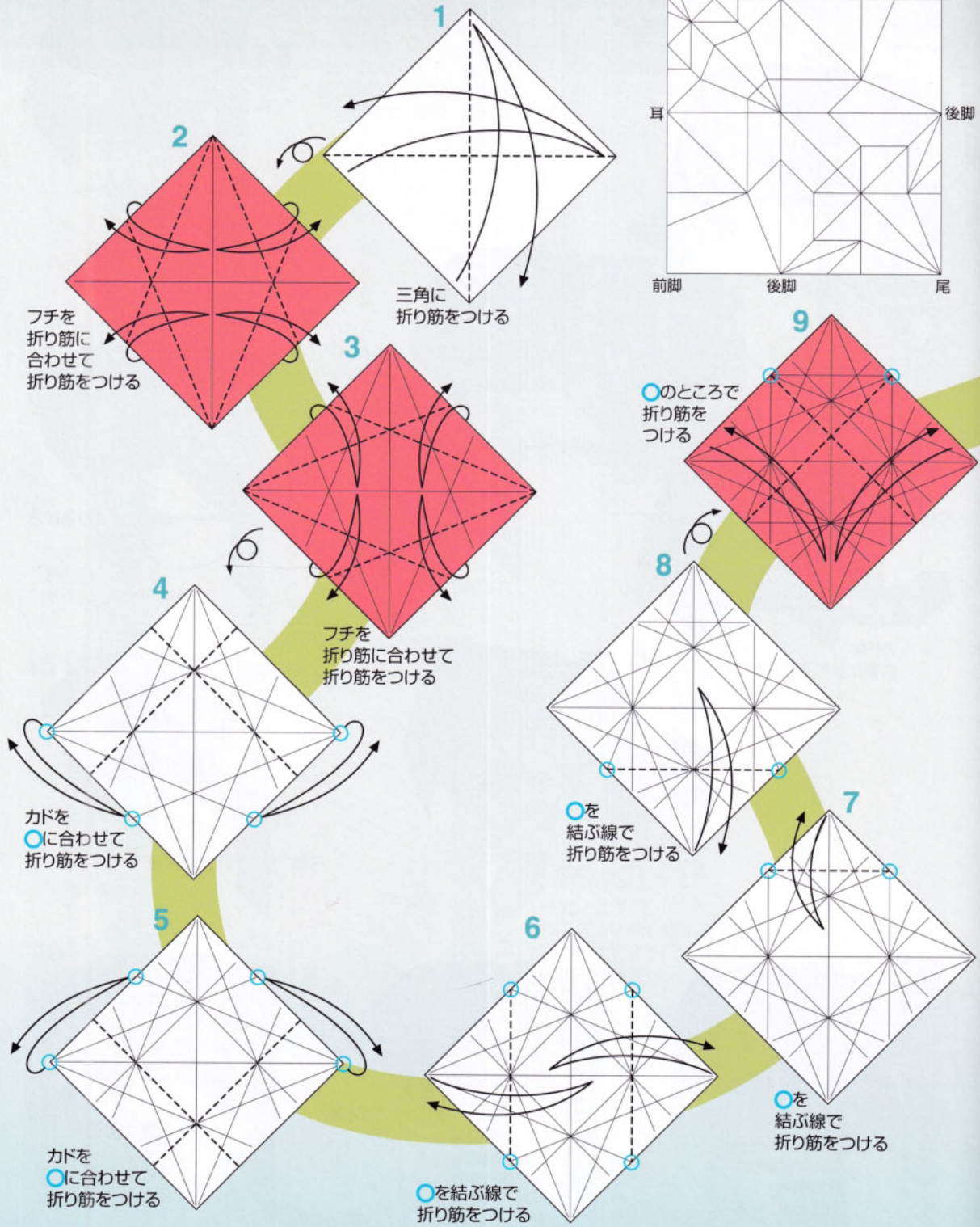
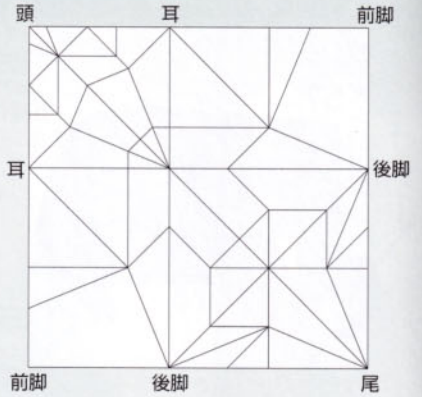

フチを折り筋に合わせて折り筋をつける

三角に折り筋をつける

○のところで折り筋をつける

フチを折り筋に合わせて折り筋をつける

カドを○に合わせて折り筋をつける

○を結ぶ線で折り筋をつける

カドを○に合わせて折り筋をつける

○を結ぶ線で折り筋をつける

○を結ぶ線で折り筋をつける

11



○を
結ぶ線で
折り筋をつける

12

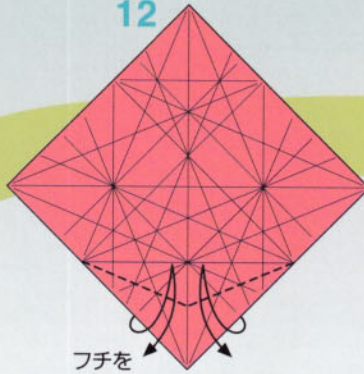

フチを
折り筋に合わせて
折り筋をつける

13

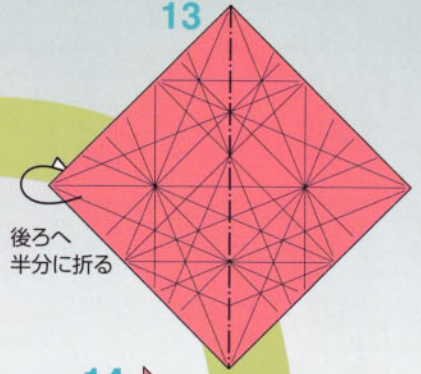

後ろへ
半分に折る

10



折り筋を
合わせて
半分の角度で
折り筋をつける

14

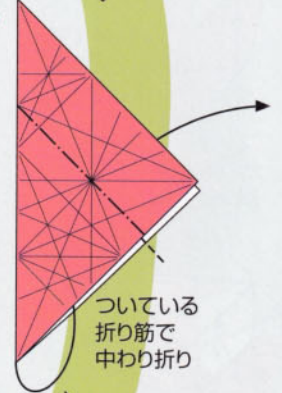

ついている
折り筋で
中わり折り

16



フチを
反対側へ折る

15

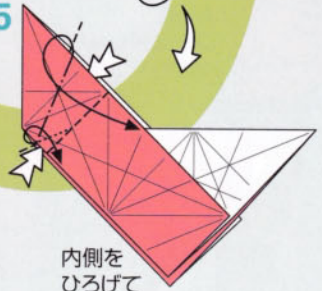

内側を
ひろげて
つぶすように折る

17

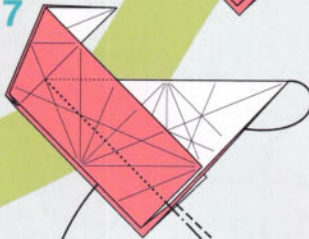

ついている折り筋で
中わり折り

18



手前のカドを
反対側へ折る

21

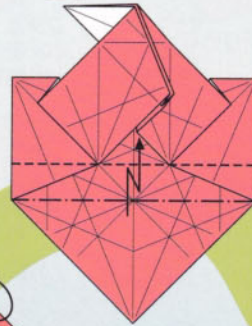

ついている
折り筋を使って
段折り

20

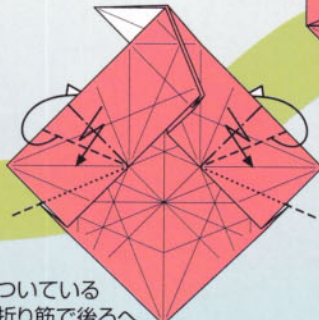

ついている
折り筋で後ろへ
引き寄せるように折る

22

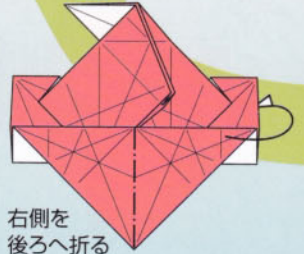

右側を
後ろへ折る

19

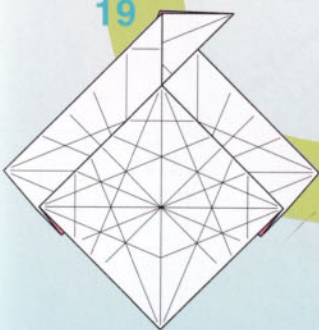

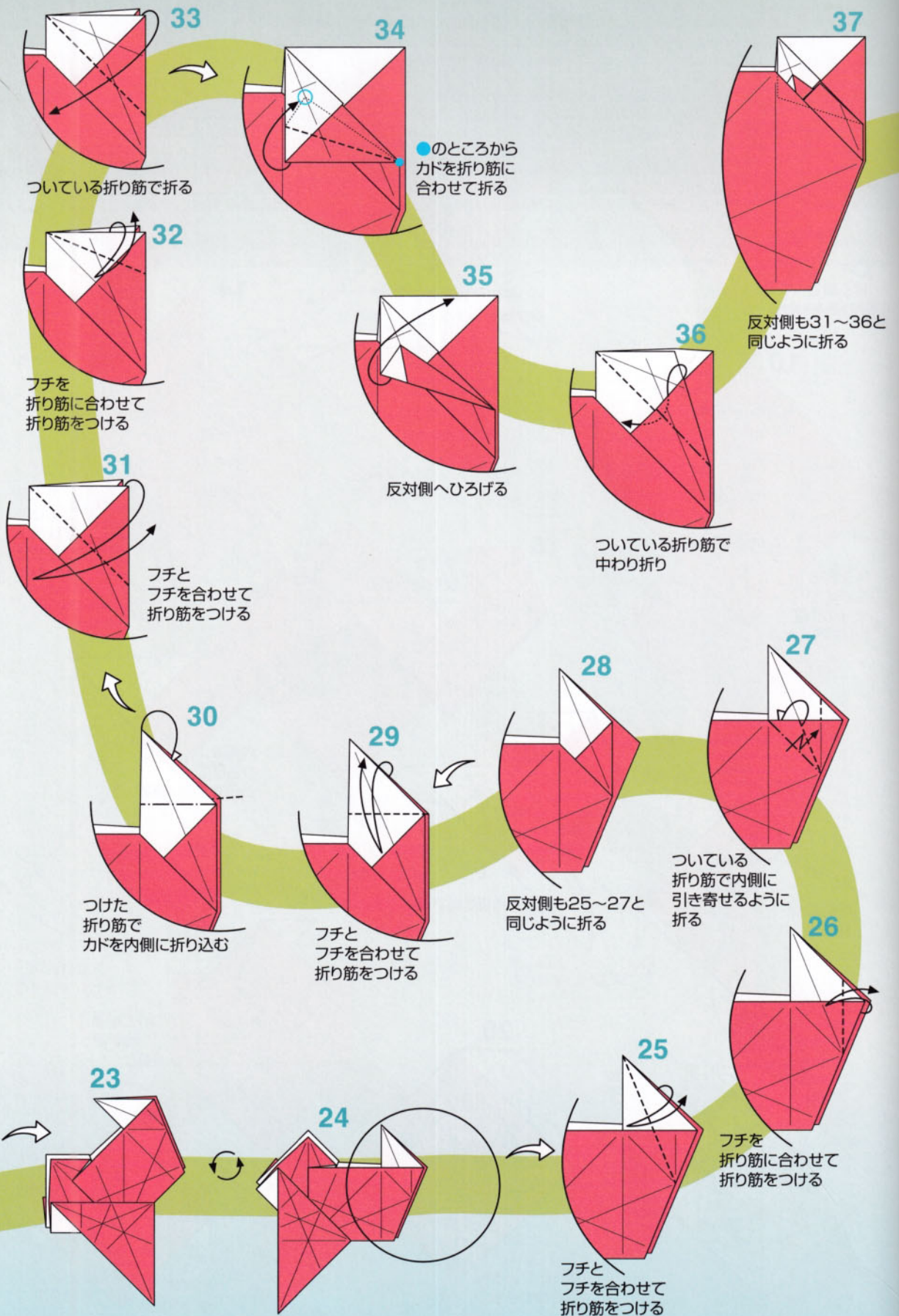

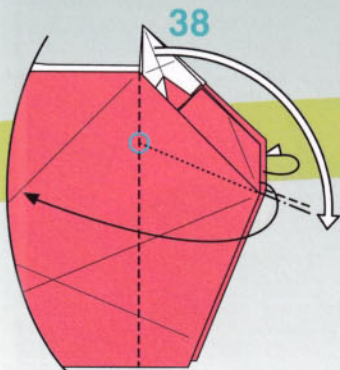

38
フチをそれぞれ
反対側へ折りながら
中心のカドを○を支点に
下げるように折る

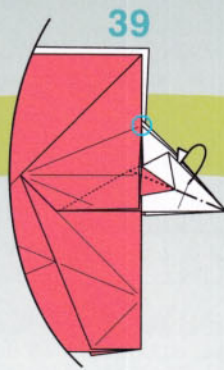

39
ついている折り筋で
手前のカドを後ろへ折る

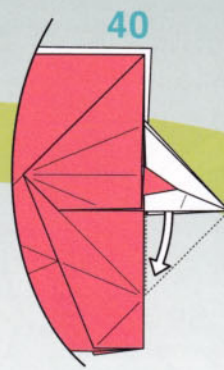

40
内側のカドを引き出す

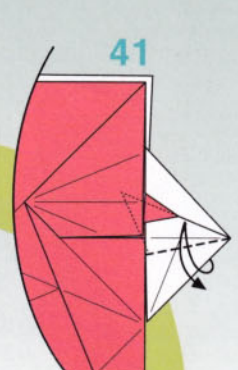

41
フチと
フチを合わせて
折り筋をつける

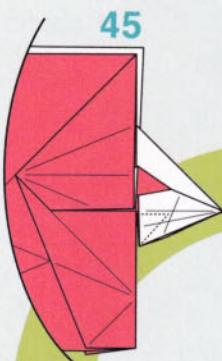

45

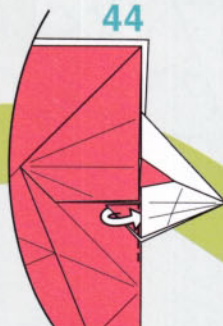

44

カドを
すき間に折り込む

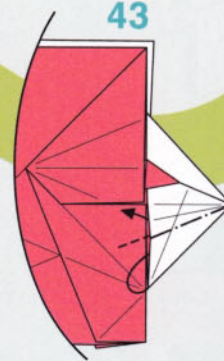

43

つけた折り筋で
中わり折り

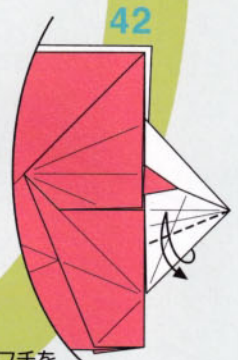

42

フチを
折り筋に合わせて
折り筋をつける

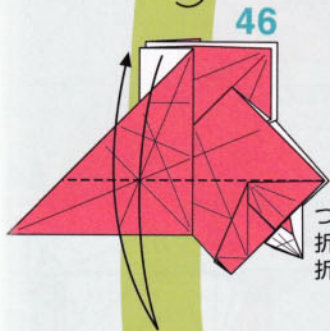

46

ついている
折り筋を使って
折り筋をつける

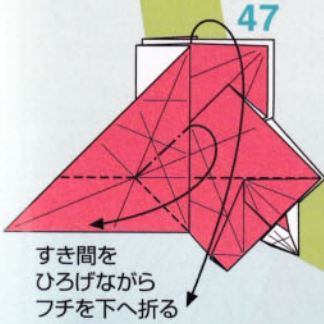

47

すき間を
ひろげながら
フチを下へ折る

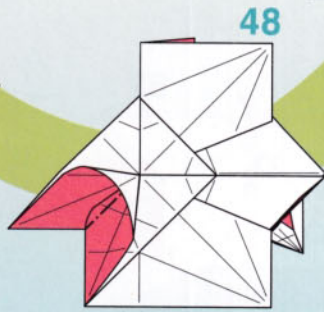

48

途中の図
平らにはならない

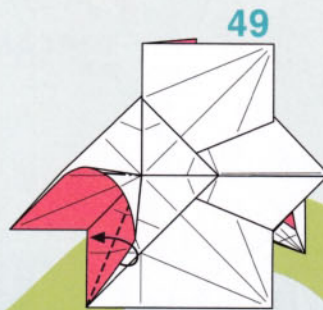

49

フチとフチを合わせて
平らに折りたたむ

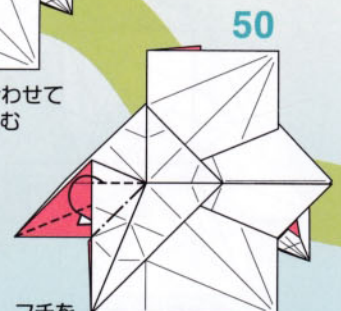

50

フチを
内側に引き寄せ
るように折る

60

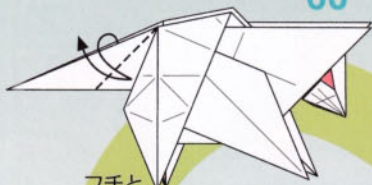

フチとフチを合わせて折り筋をつける

64

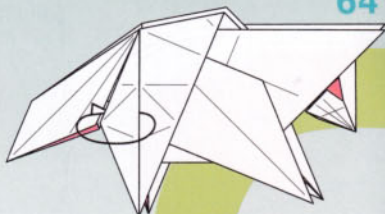

フチを後ろへかぶせる
反対側も同じように折る

61



フチをつけた折り筋に
合わせて折り筋をつける

63



手前のフチを
引き出しながら段折り
反対側も同じように折る

59



ついている
折り筋で後ろへ
折る

62

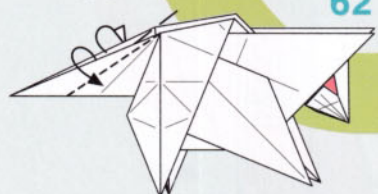

つけた折り筋で
かぶせ折り

58

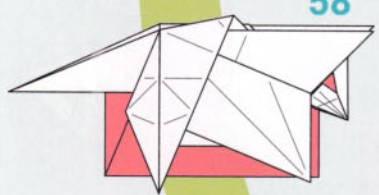

反対側も52~56と
同じように折る

55



フチとフチを合わせて
○を結ぶ線につぶす
ように折る

57



56



引き寄せるように
折る

54

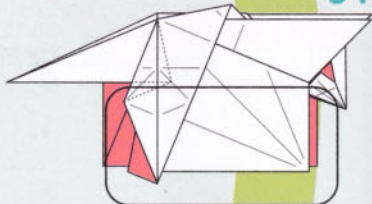

次の図は手前の部分を
裏から見る

51

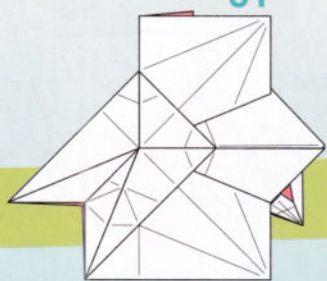

反対側も46~50と
同じように折る

52

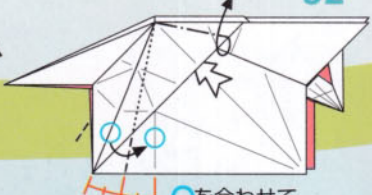

○を合わせて
ずらすように折る

53

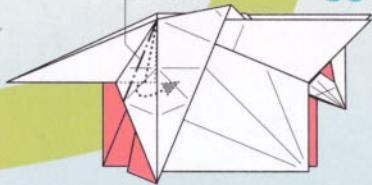

ついている折り筋

ついている折り筋をつまんで
たるんだ部分を内側に
ずらすように折る

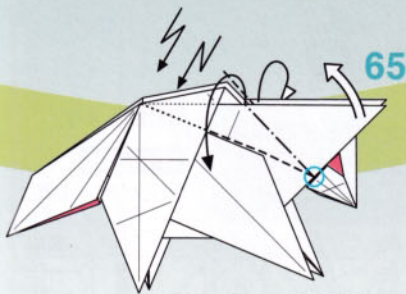

65
○を支点にフチを両側で
かぶせるように段折り

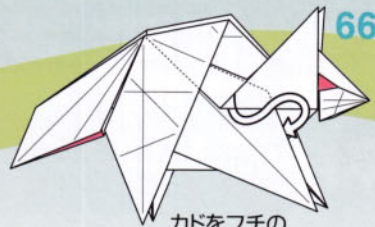

66
カドをフチの
下に差し込む
反対側も同じ

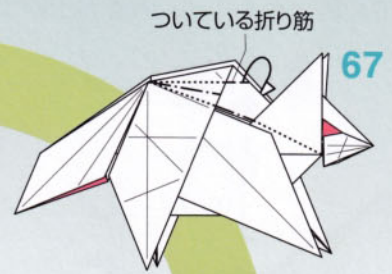

67
ついてる折り筋
ついてる折り筋をつまんで
内側に引き寄せるように折る
反対側も同じように折る

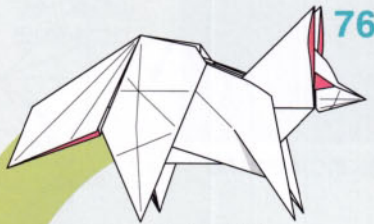

76
できあがり

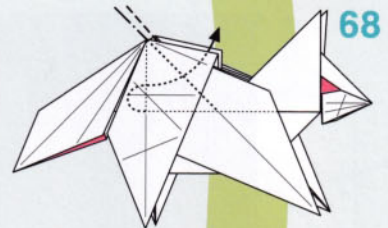

68
内側のカドを出すように
中わり折り

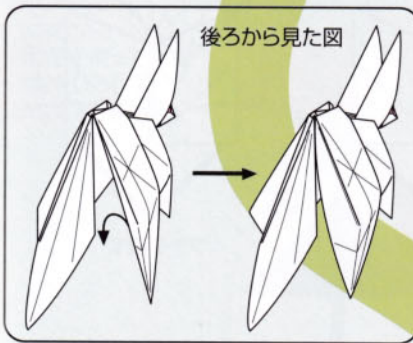

後ろから見た図

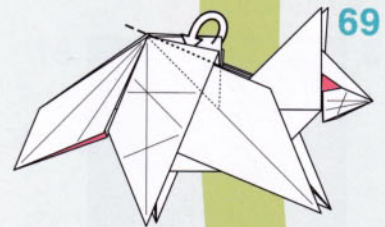

69
カドを手前に折って
ひらき留めにする

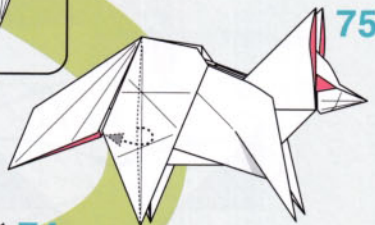

75
フチを起こして
後ろ脚を立体にする
反対側も同じ



70
カドを内側に折る

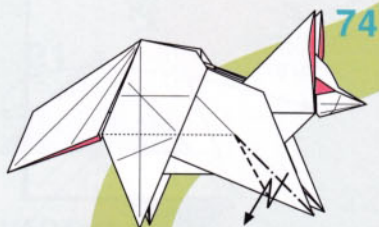

74
斜めに段折り
反対側も同じ
ように折る



71
フチを
押し込んで
顔を立体的に
する

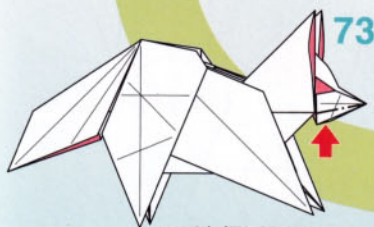

73
フチを押し込んで
頭の形を整える

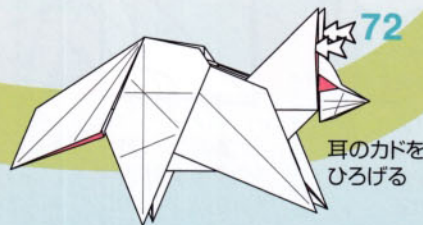

72
耳のカドを
ひろげる

Fox wedding -Retainers- 狐の嫁入り-お付きの狐-

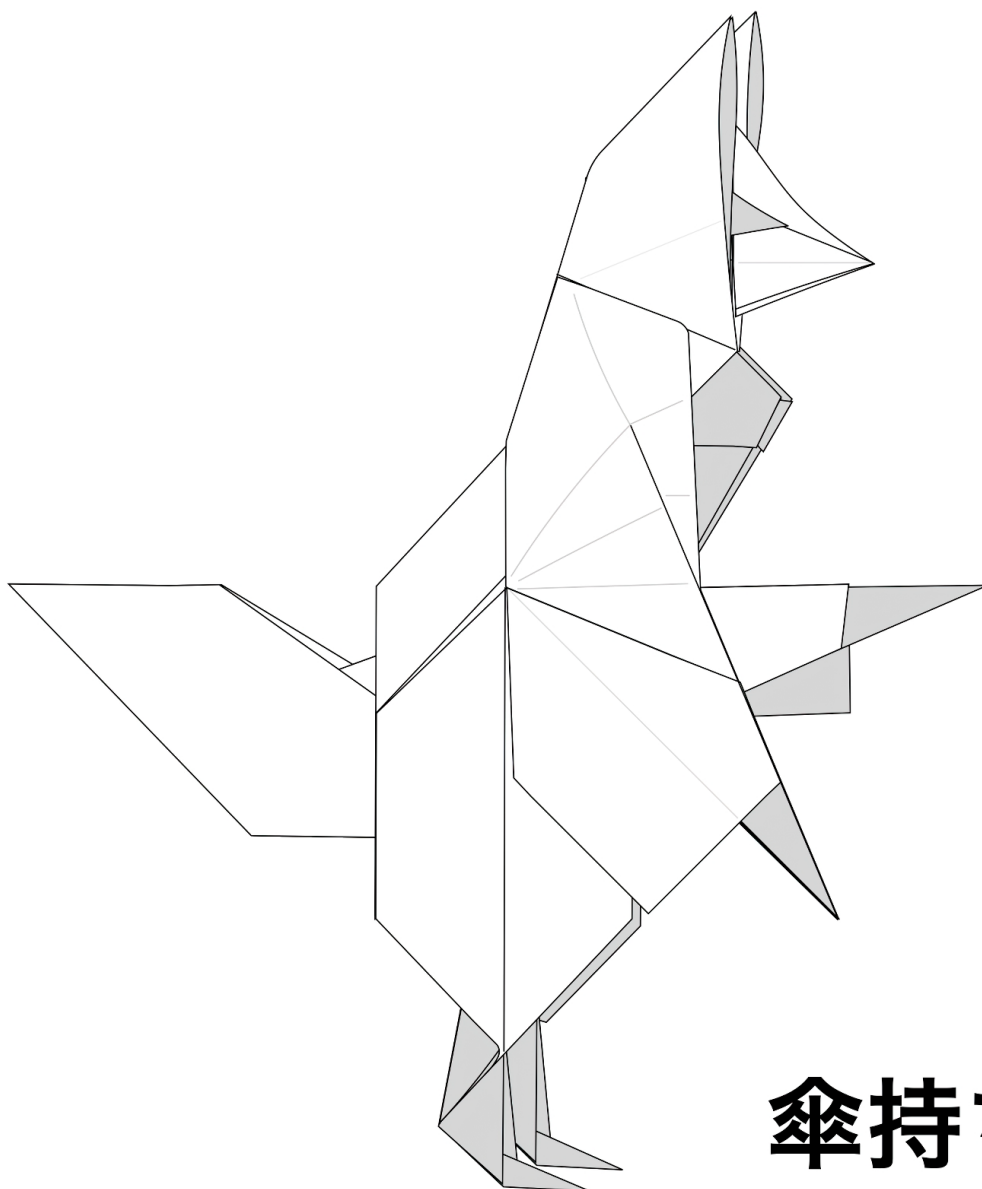

傘持ち

根据作品CP绘制，CP版权归原创作者勝田恭平，本折图仅供个人使用。

狐の嫁入り-お付きの狐- 傘持ち

创作：勝田恭平 Katsuta Kyohei
绘图：牛乾

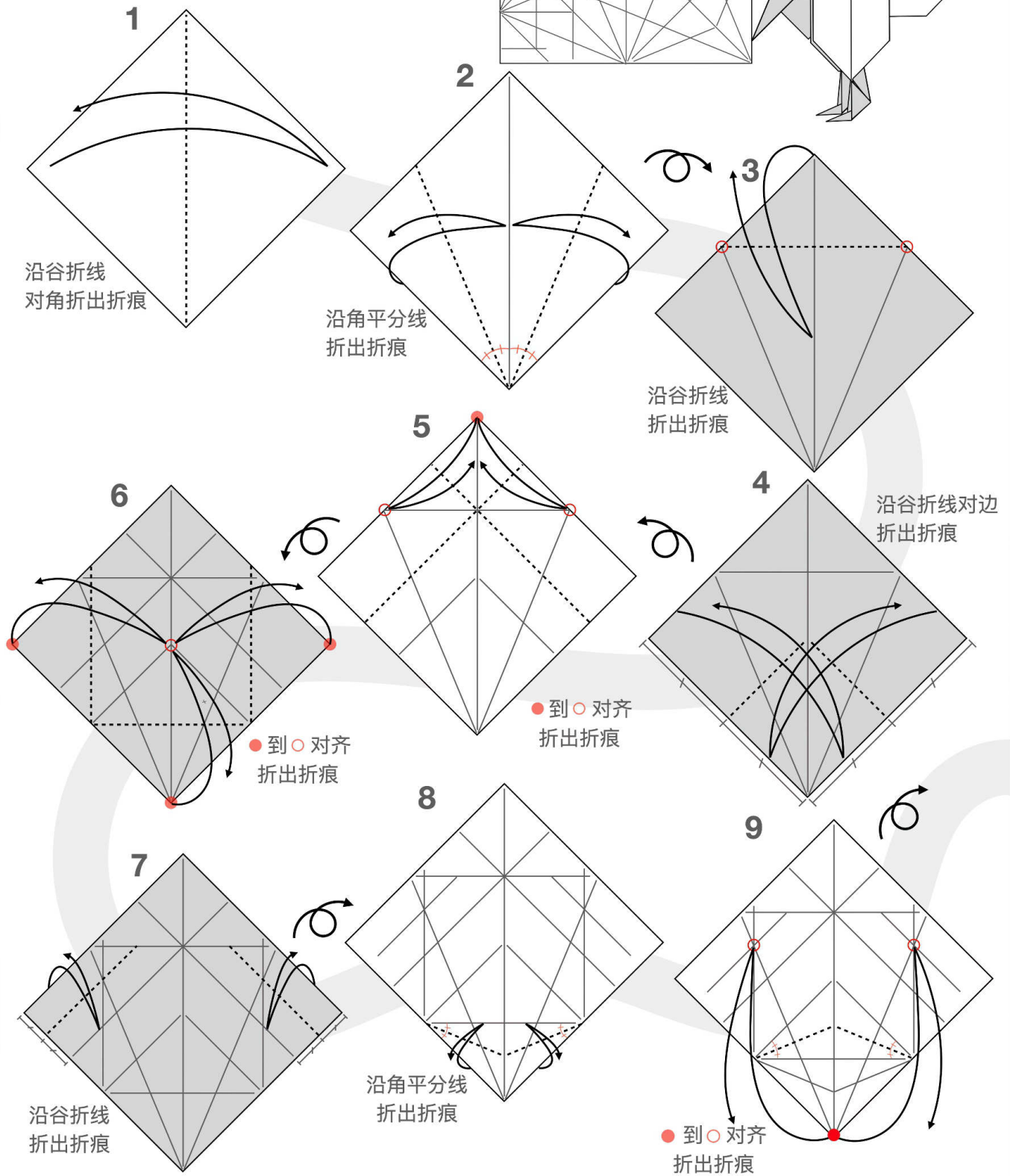
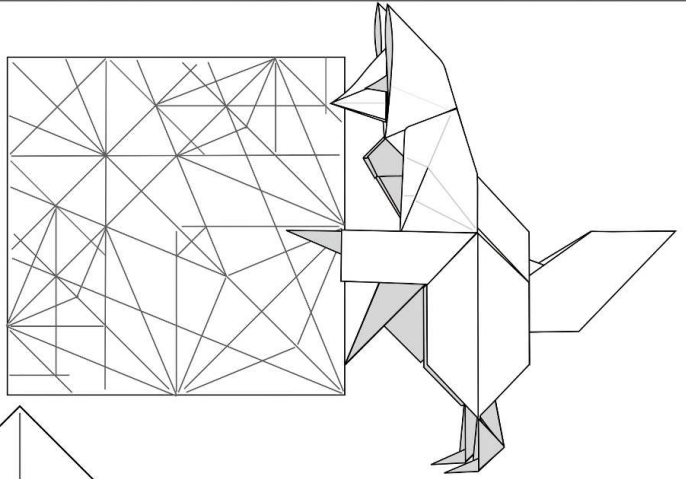

1 狐の嫁入り-お付きの狐-傘持ち

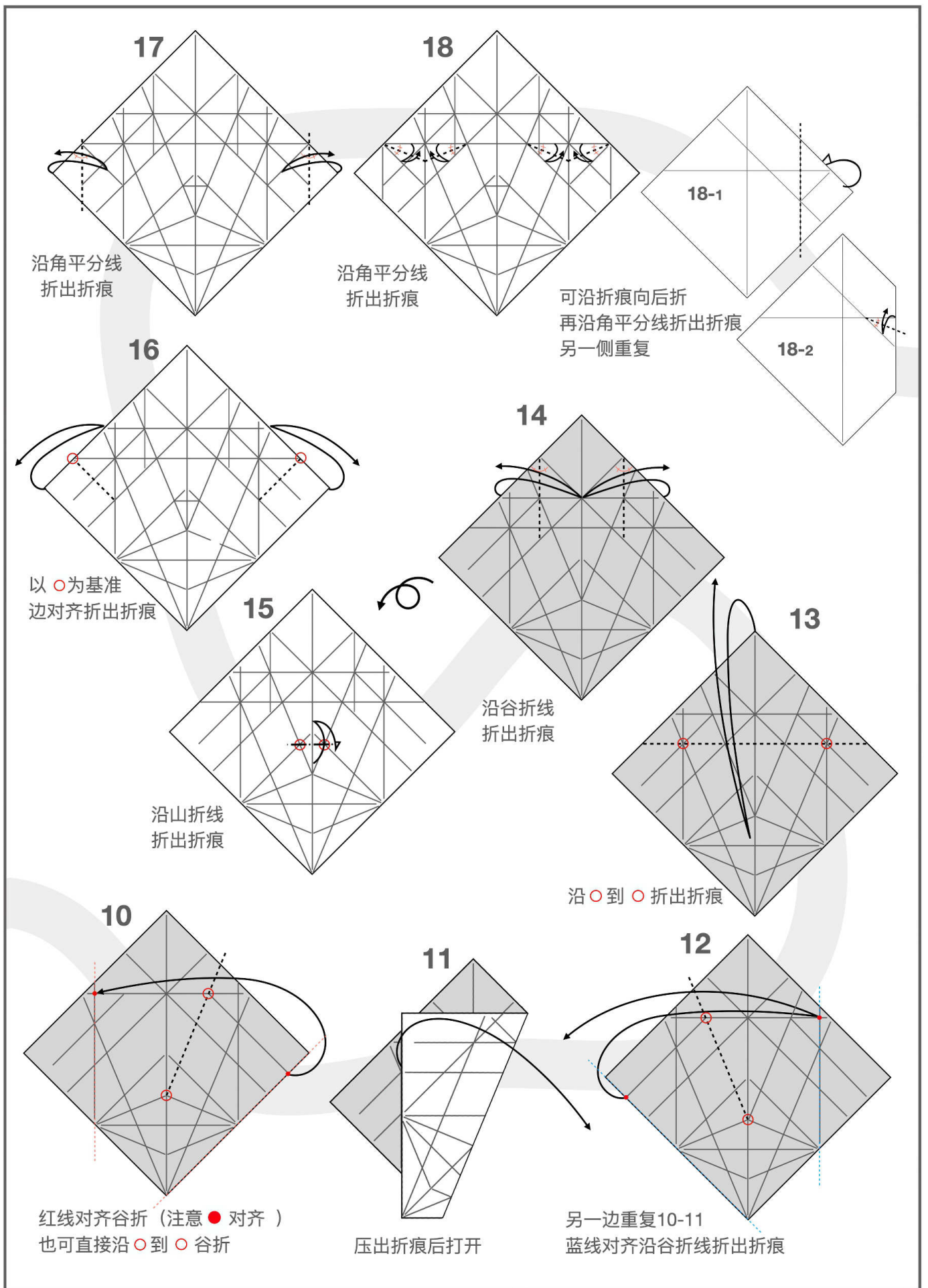

2 狐の嫁入り-お付きの狐-傘持ち

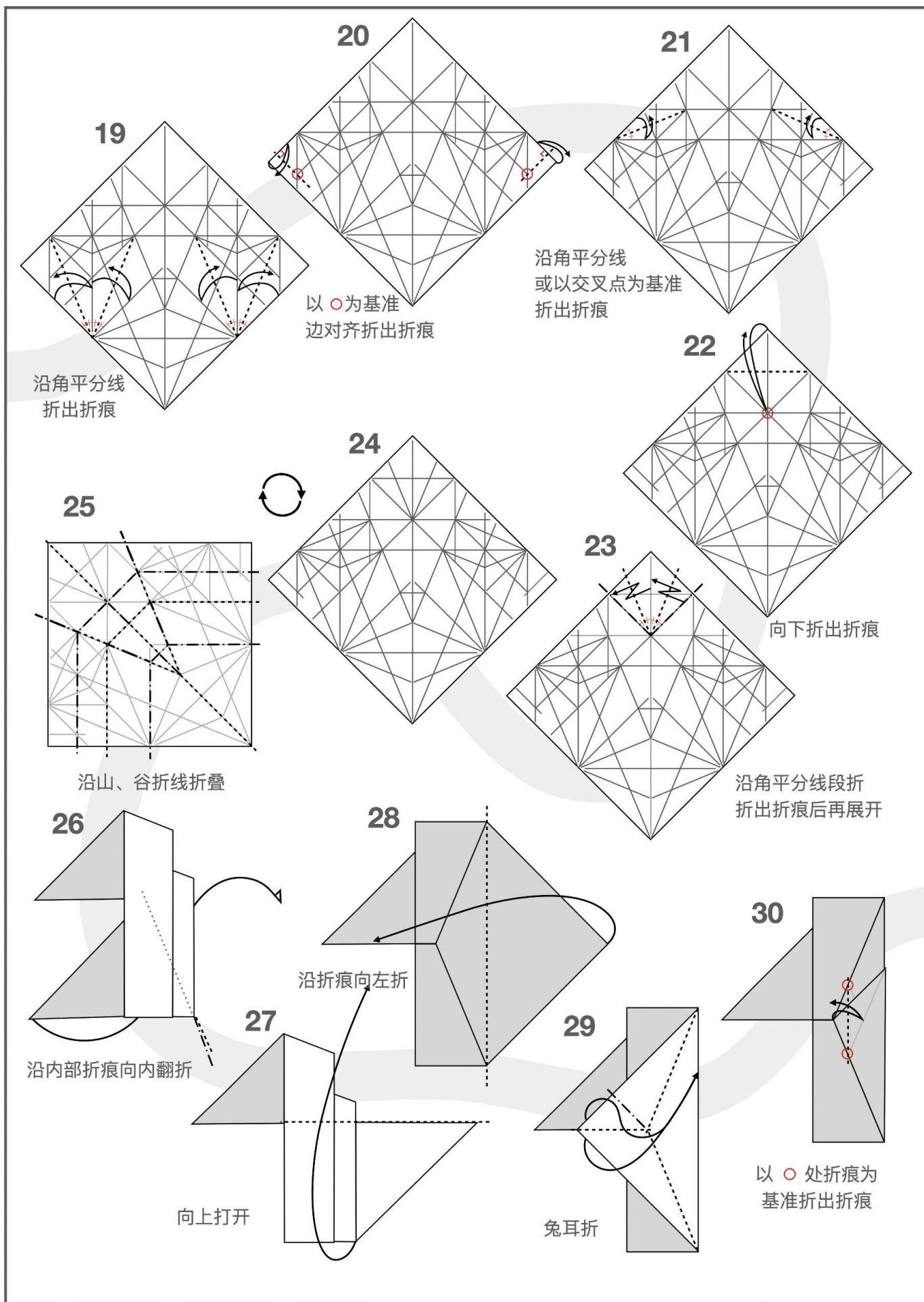

3 狐の嫁入り-お付きの狐-傘持ち

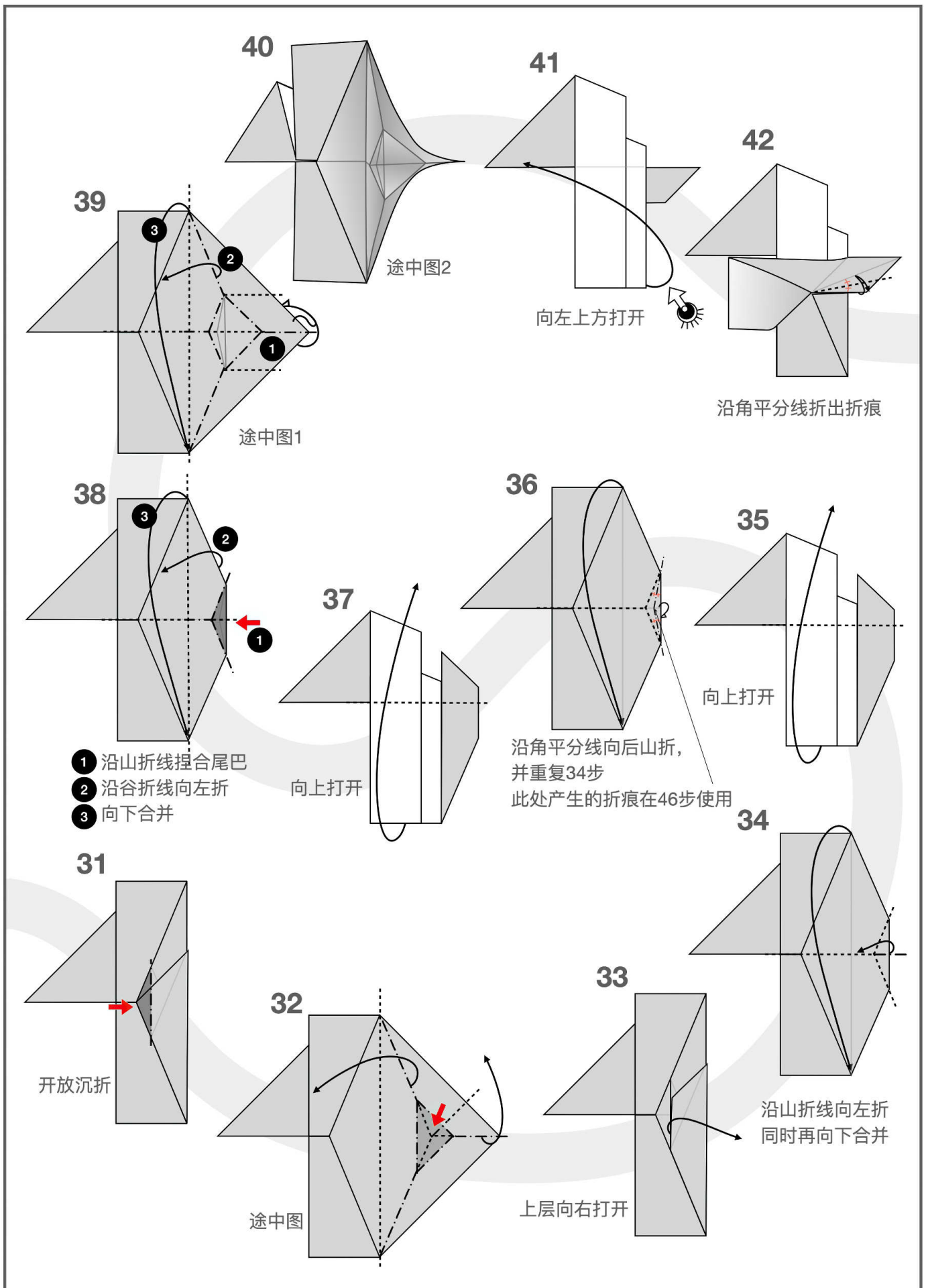

4 狐の嫁入り-お付きの狐-傘持ち

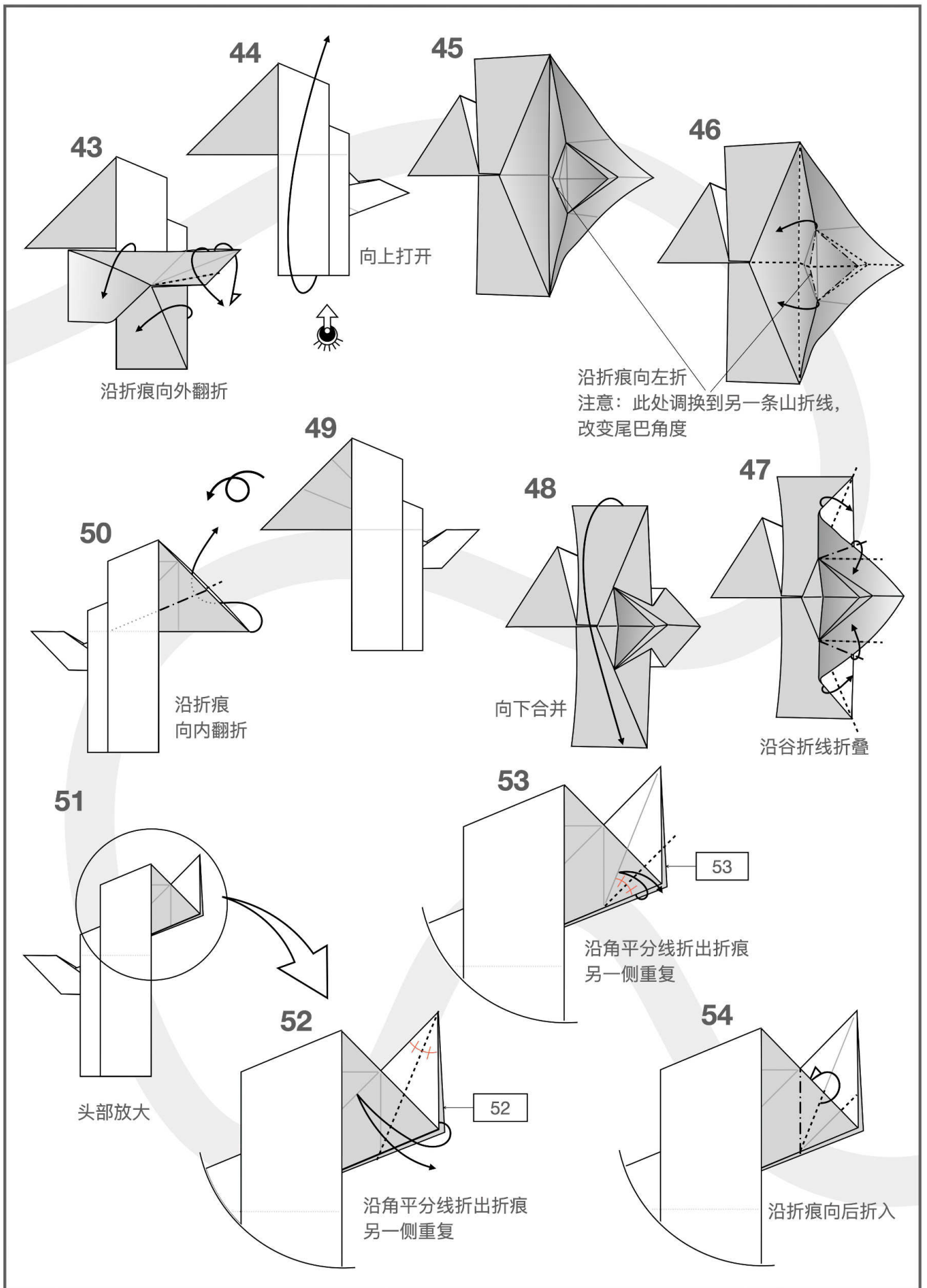

5 狐の嫁入り-お付きの狐-傘持ち

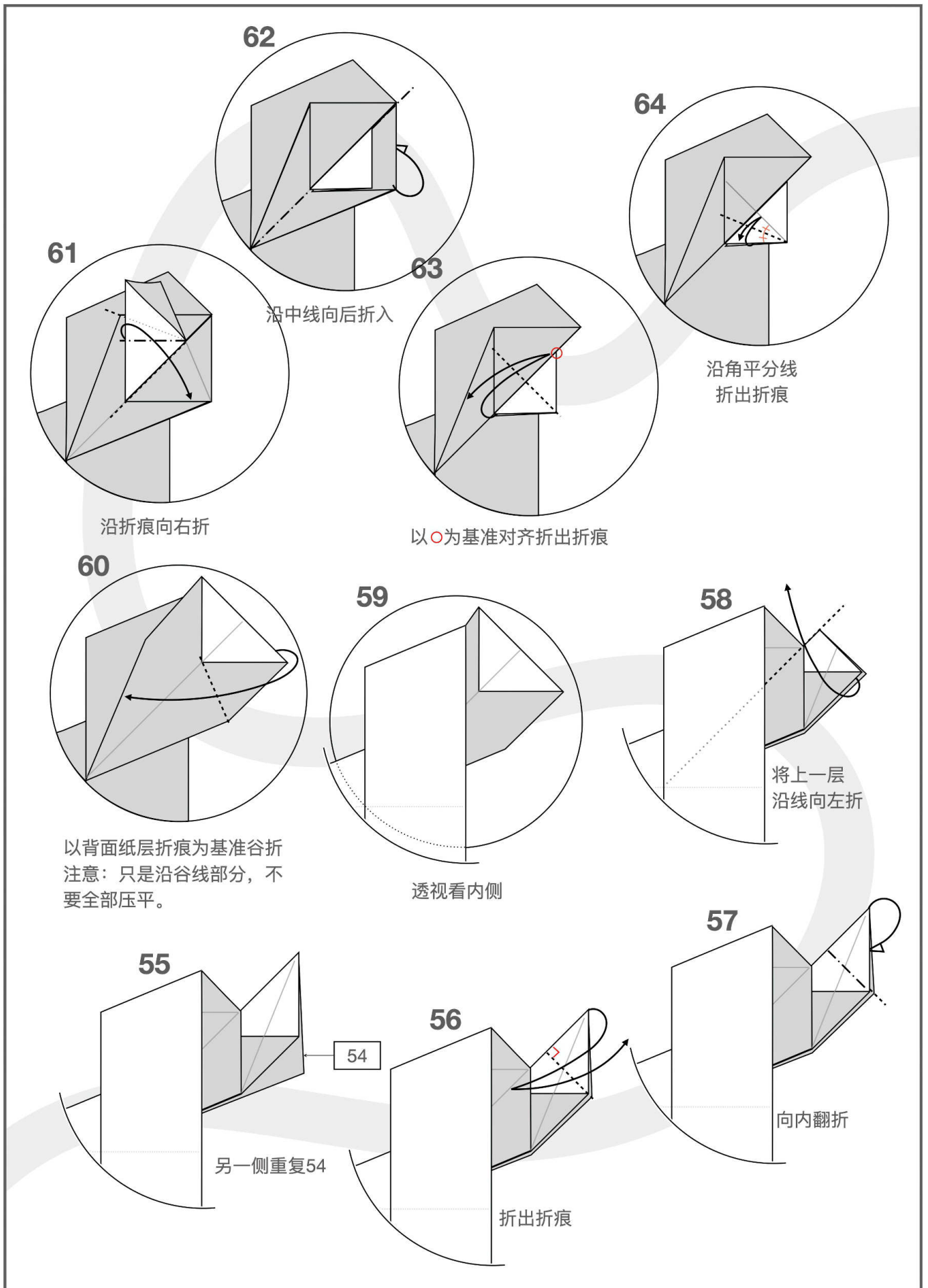

6 狐の嫁入り-お付きの狐-傘持ち

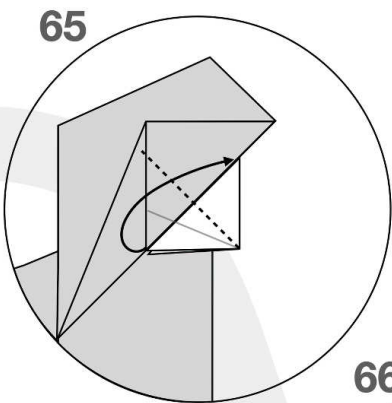

沿折痕谷折

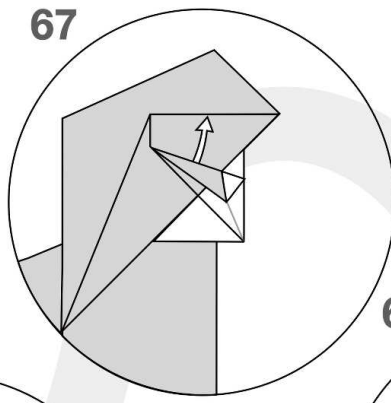

将里面部分拉出

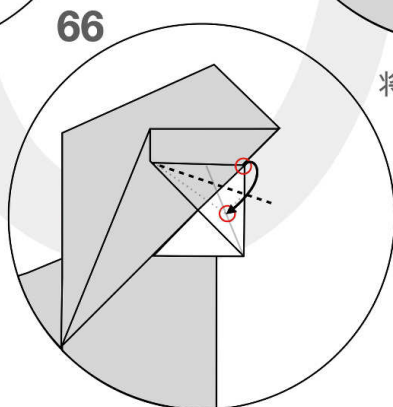

注意：以折痕位置为基准谷折

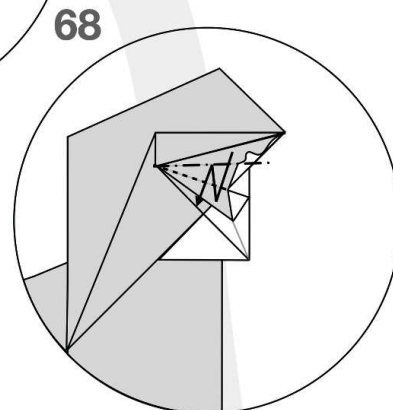

沿折痕段折压平

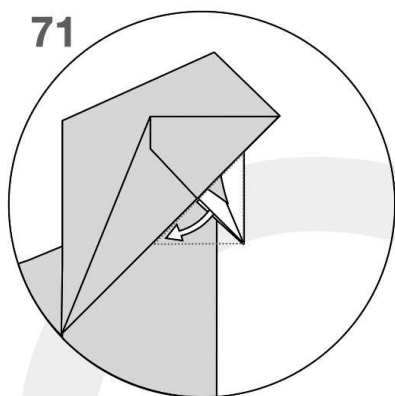

将内部纸层拉出

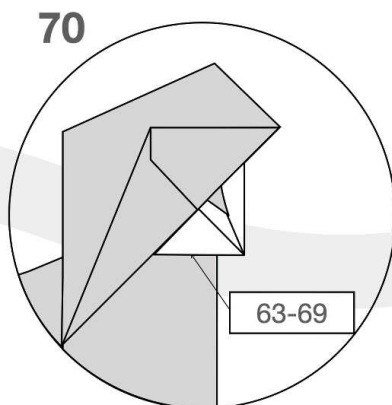

另一侧重复63-69

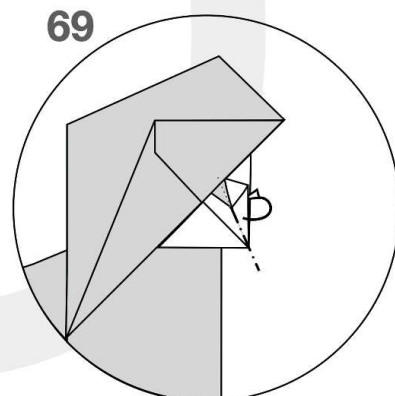

沿折痕向后折入

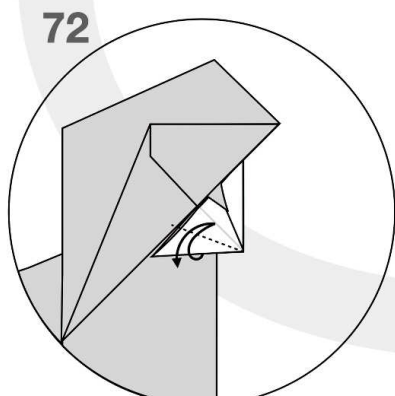

折出折痕

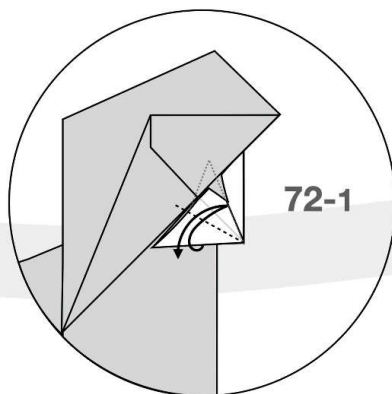

72步这里可以改变折叠角度，使嘴部更细小一些。

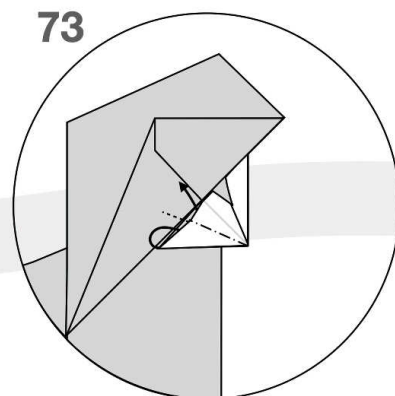

向内翻折

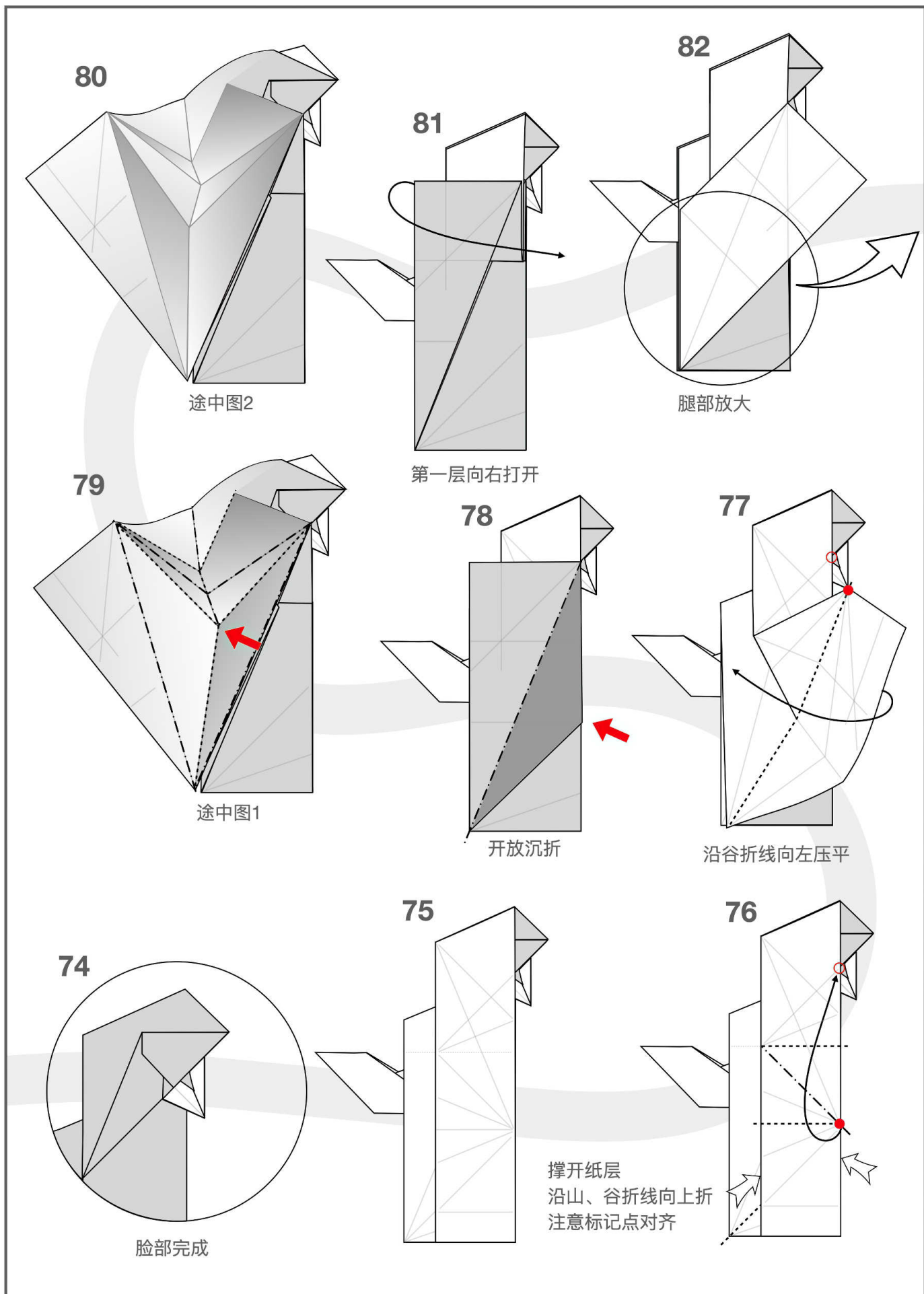

8 狐の嫁入り-お付きの狐-傘持ち

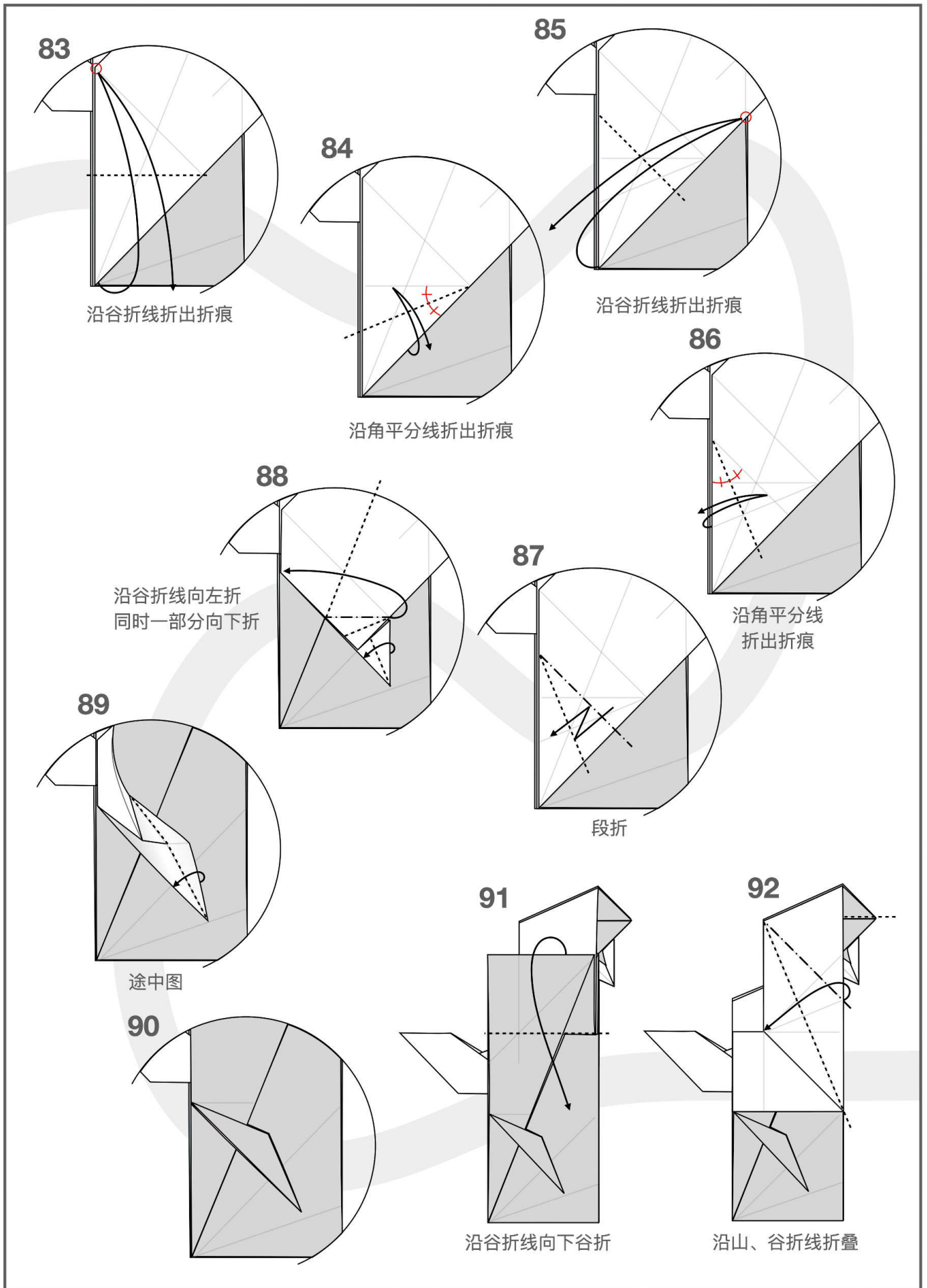

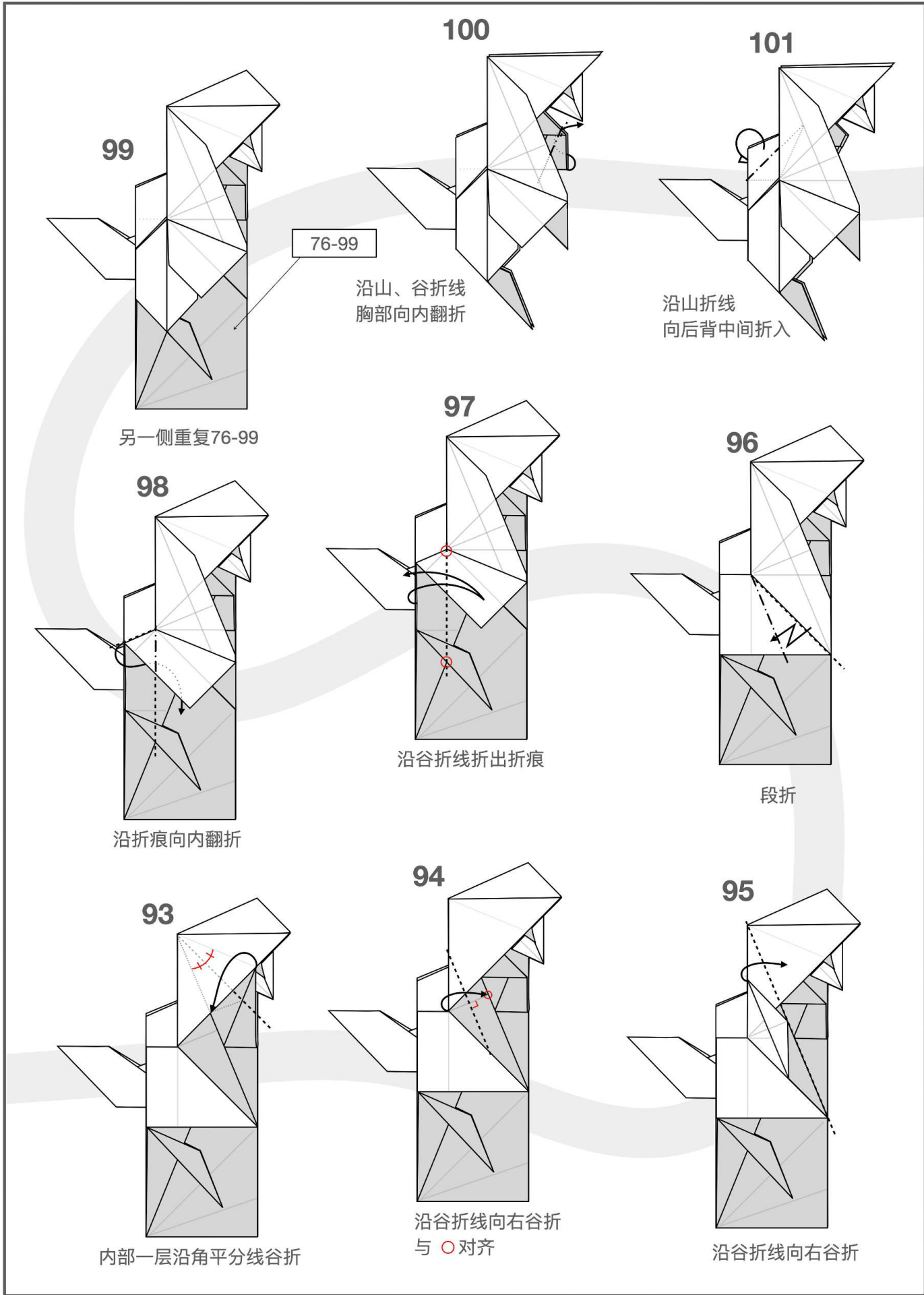

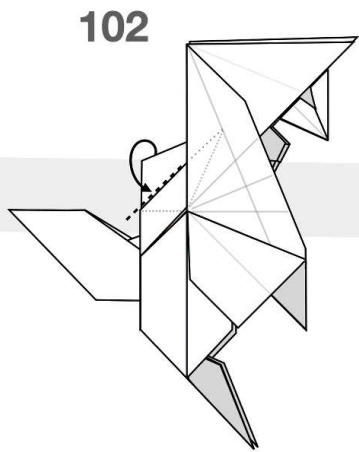

102
另一侧沿谷折线
向后背中间折入

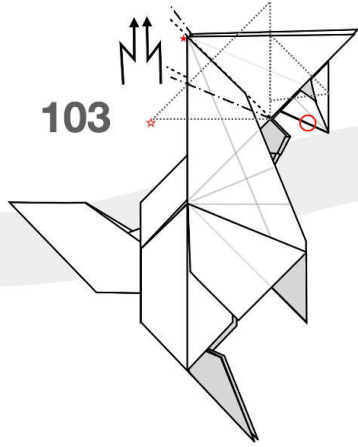

103
两侧沿山、谷折线同时段折
将头部以○位置为轴心旋转45°

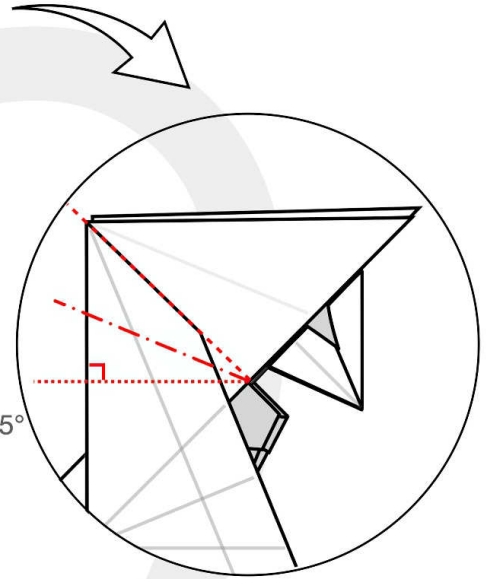

取线参照
先沿谷折线段折到45°位置
与参照线对齐后
再把山折线压平

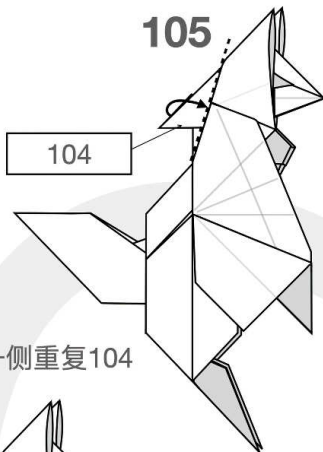

104
另一侧重复104

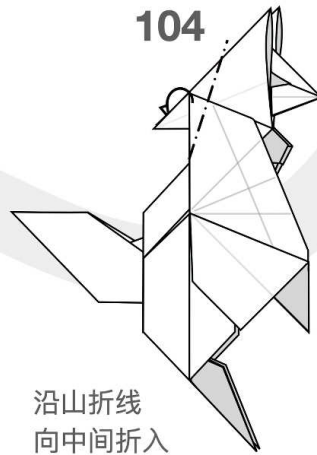

105
沿山折线
向中间折入

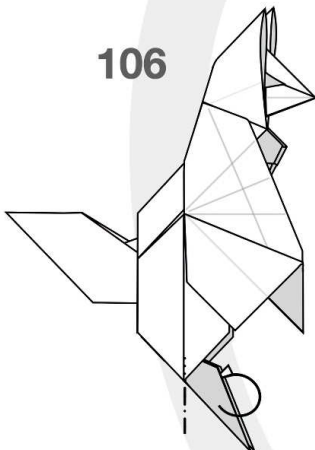

106
右腿部沿山折线
向后折叠

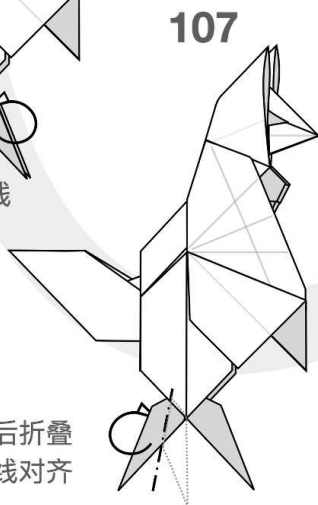

107
沿山折线再向后折叠
将边与身体中线对齐

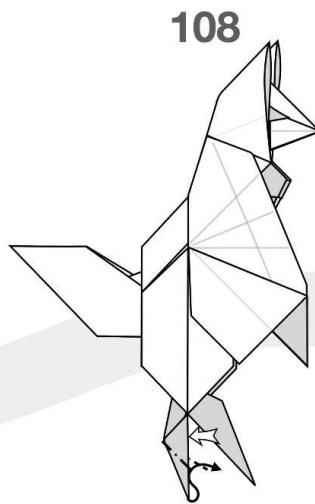

108
从纸层中间撑开
沿山、谷折线向内翻折

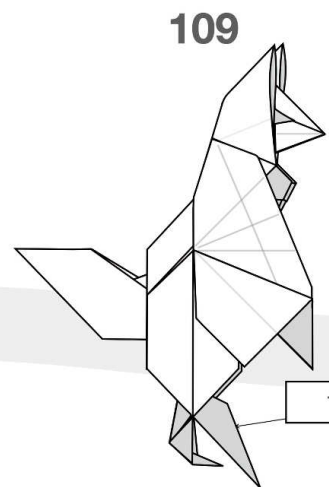

109
另一侧左腿重复108

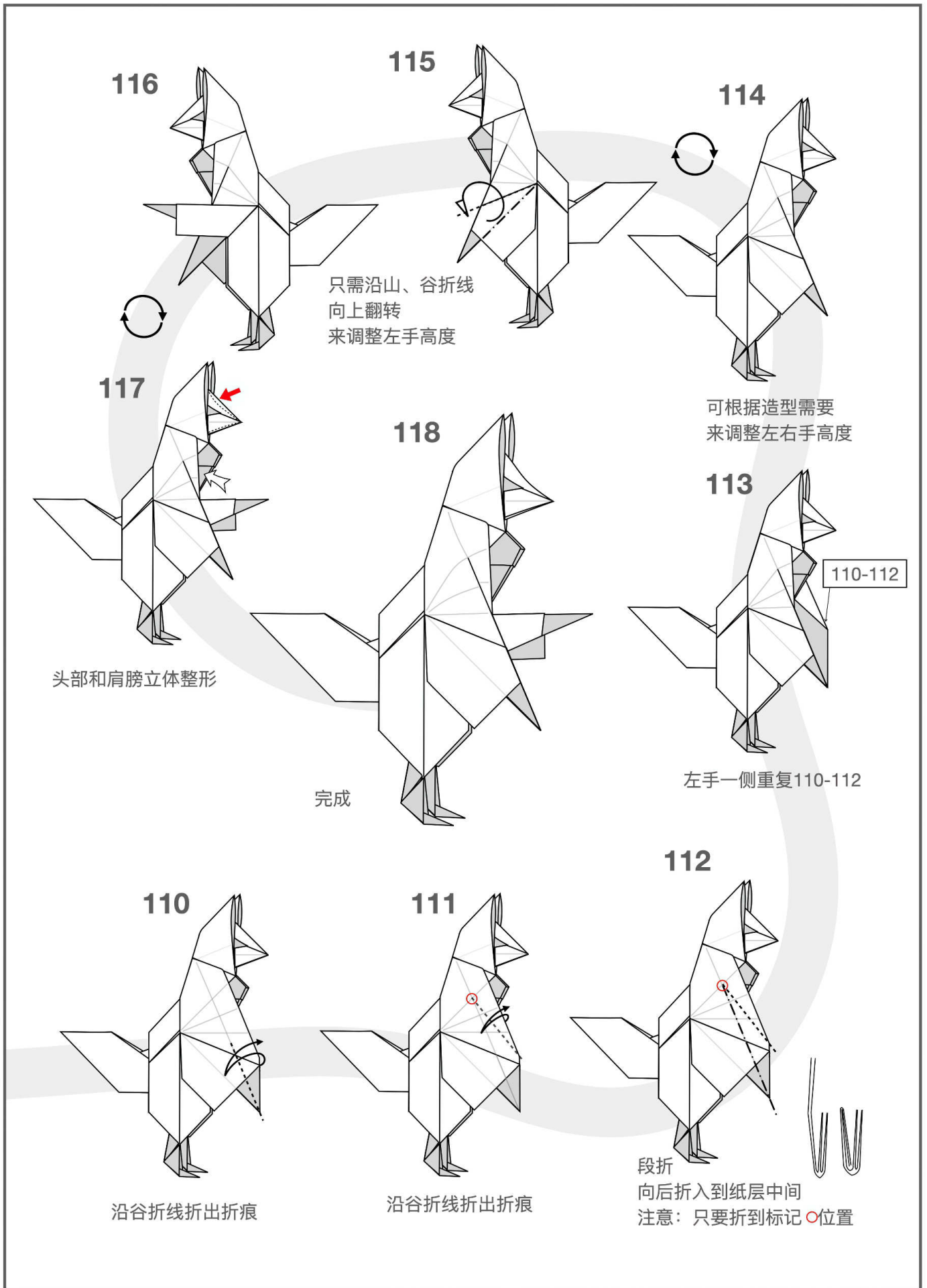

116

115

114

117

118

可根据造型需要
来调整左右手高度

110-112

头部和肩膀立体整形

完成

左手一侧重复110-112

110

111

112

沿谷折线折出折痕

沿谷折线折出折痕

段折
向后折入到纸层中间
注意：只要折到标记○位置

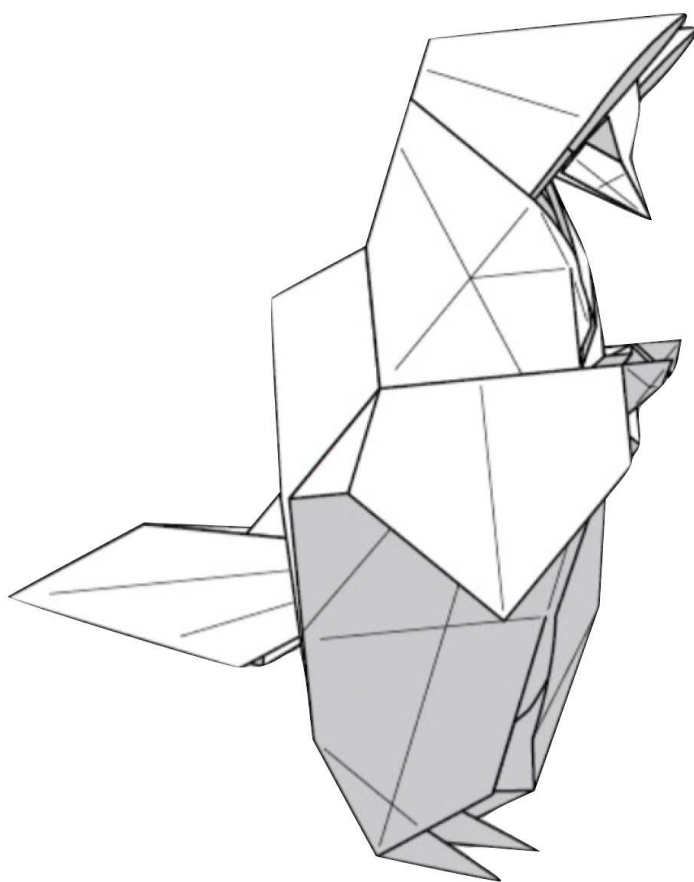

提灯持ち

by Katsuta Kyohei

创作：胜田恭平

实拍折图：niuqian

本教程根据作品CP制作，版权归原创者胜田恭平，仅供个人学习参考使用。

提灯持ち

by Katsuta Kyohei

创作：胜田恭平

实拍折图：niuqian

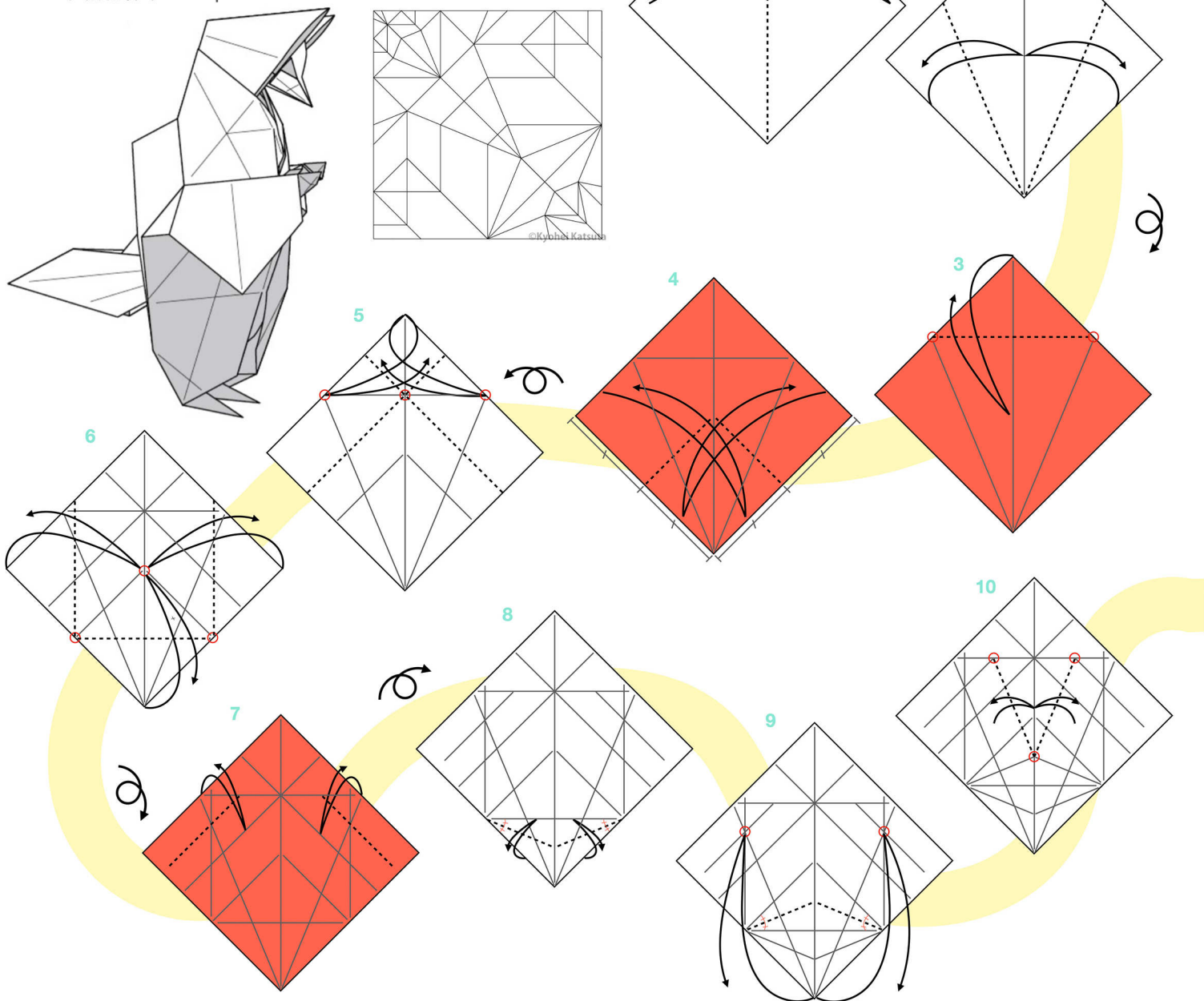

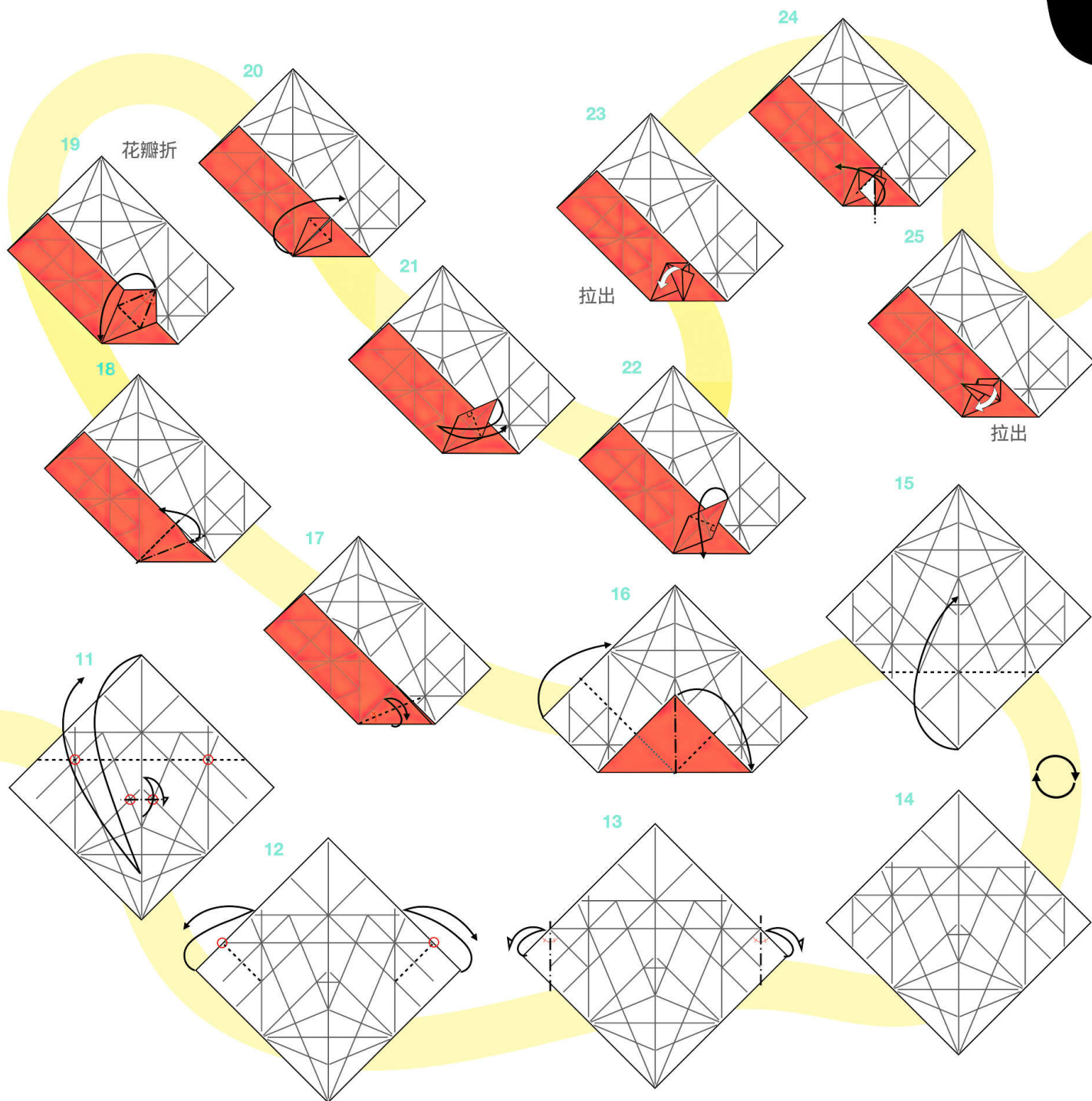

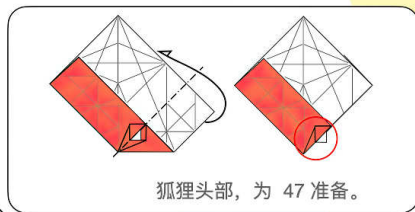
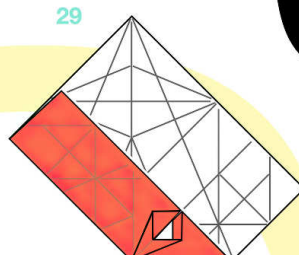
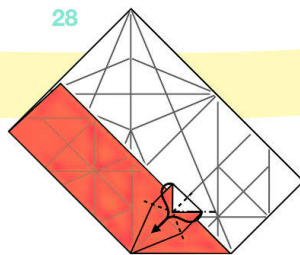
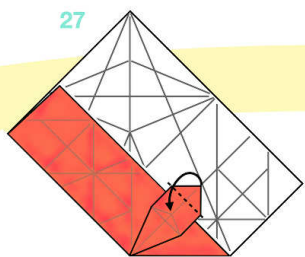
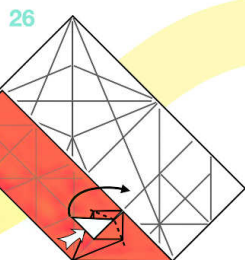

狐狸头部，为 47 准备。

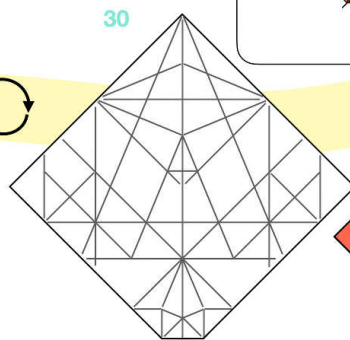
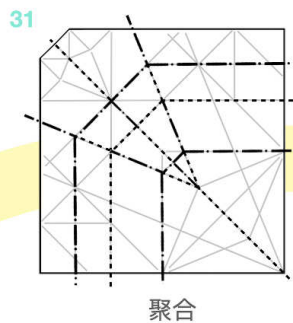
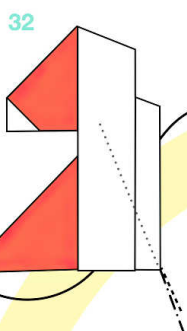

展开

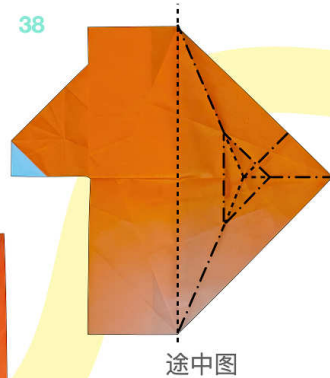
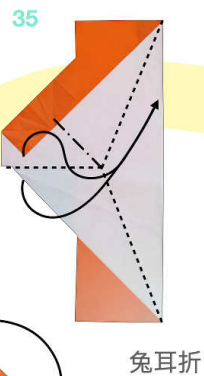
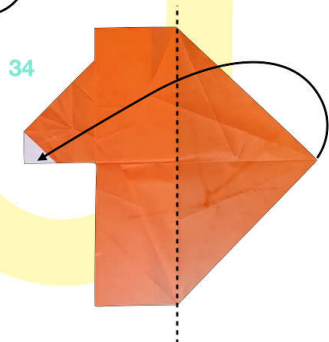
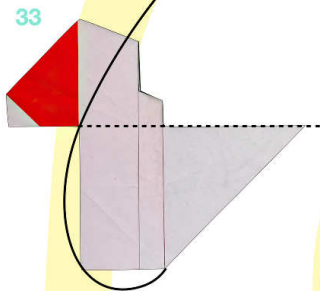
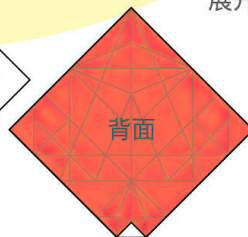

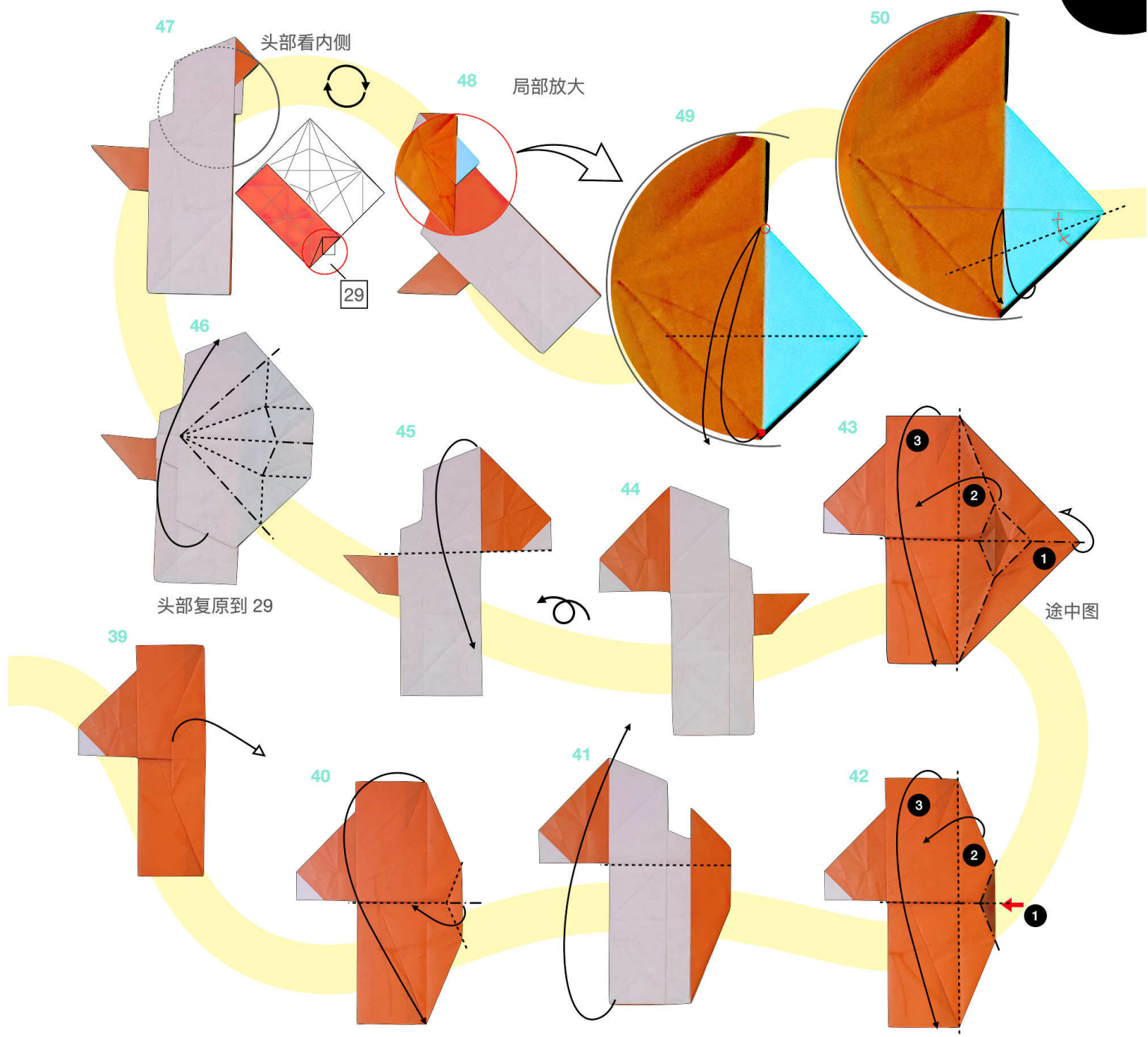

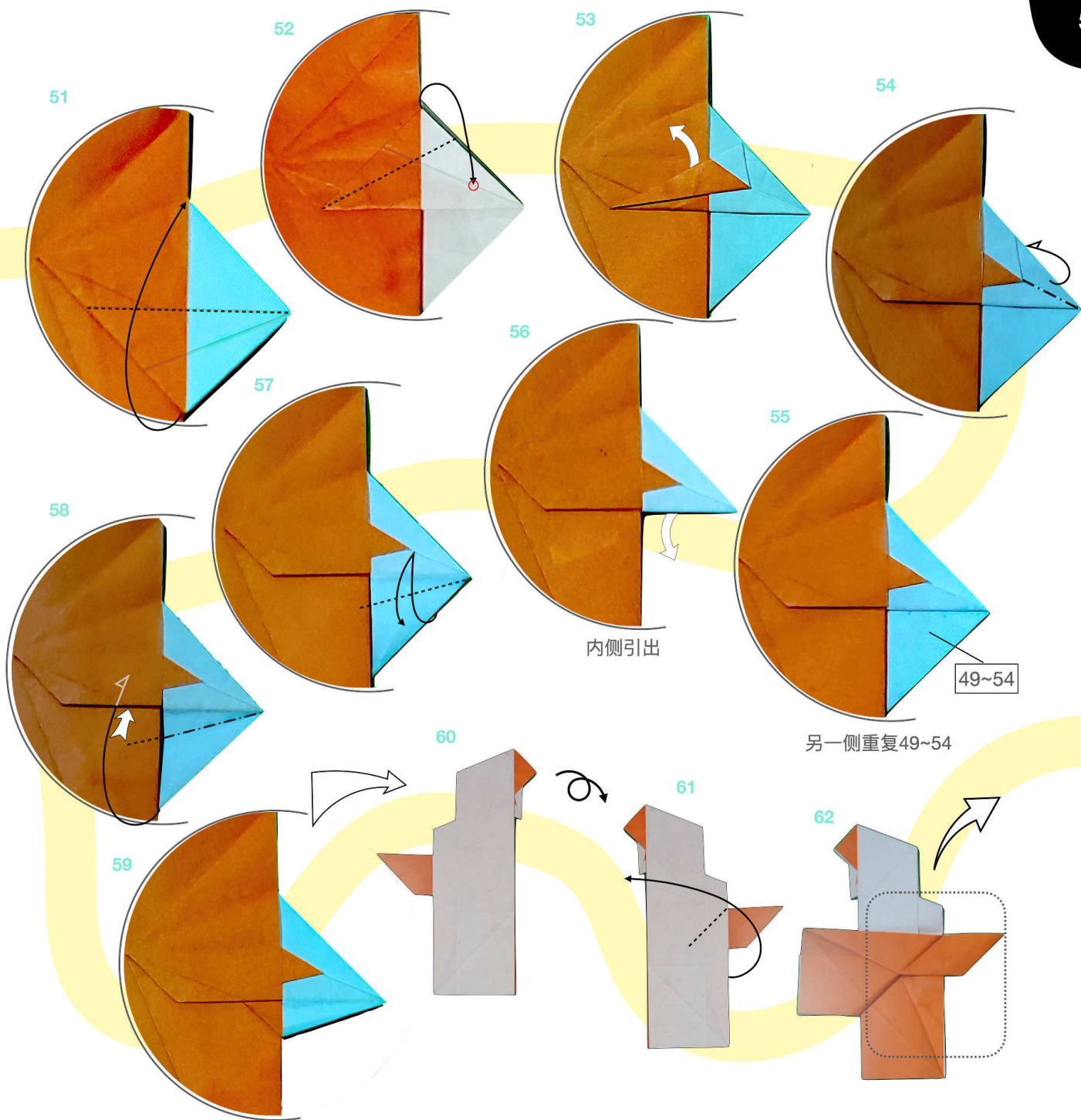

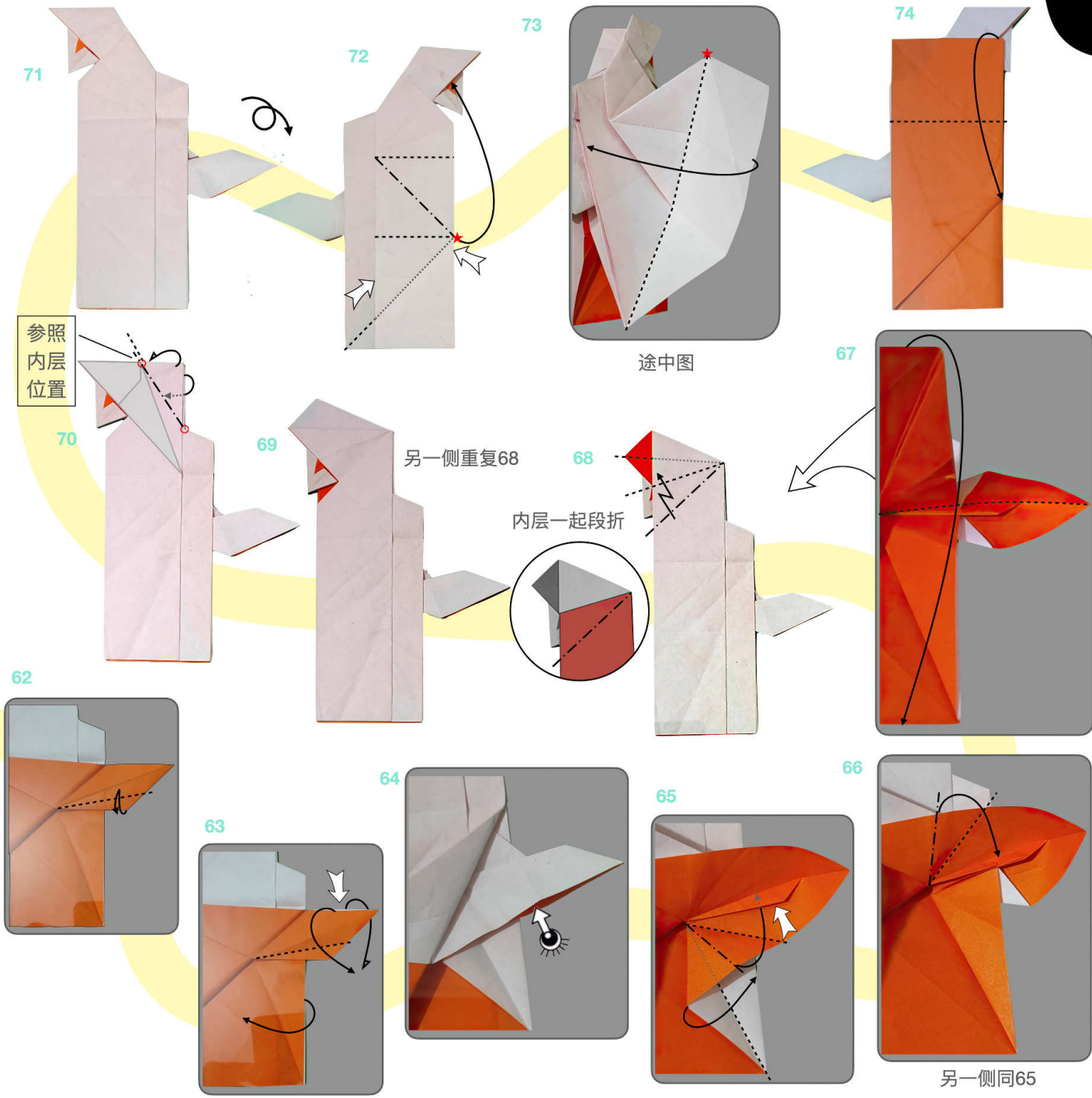

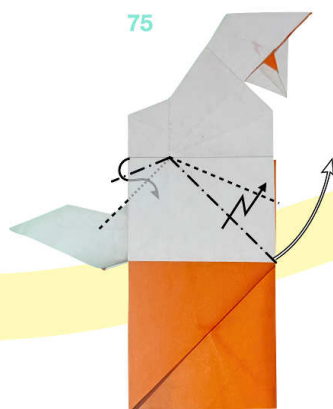

75



76

展开



77

段折后展开

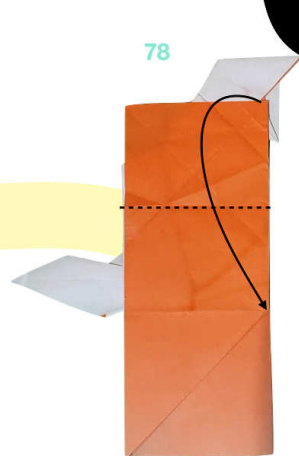

78



82



81

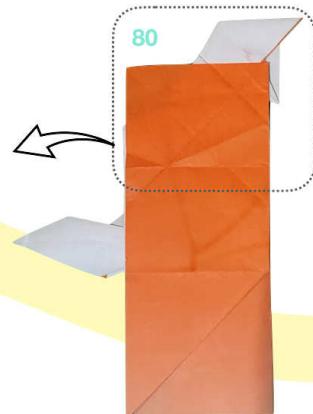

80

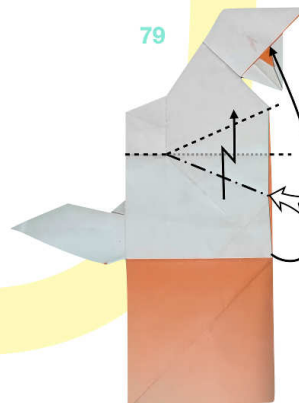

79

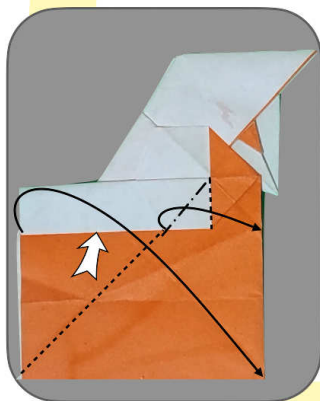

83

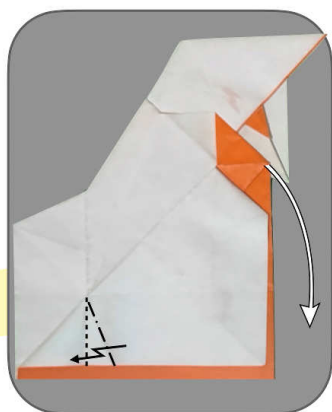

84

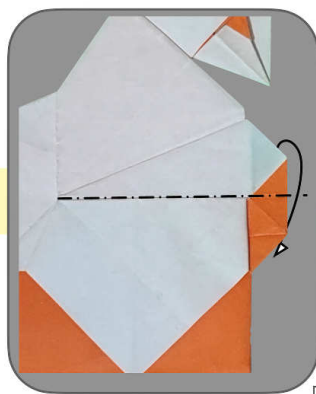

85

还原到76

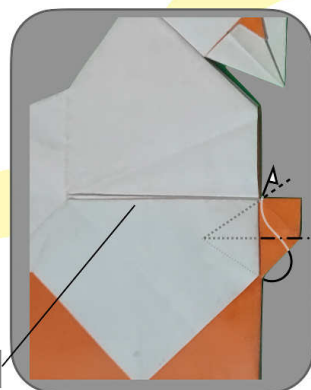

86

76

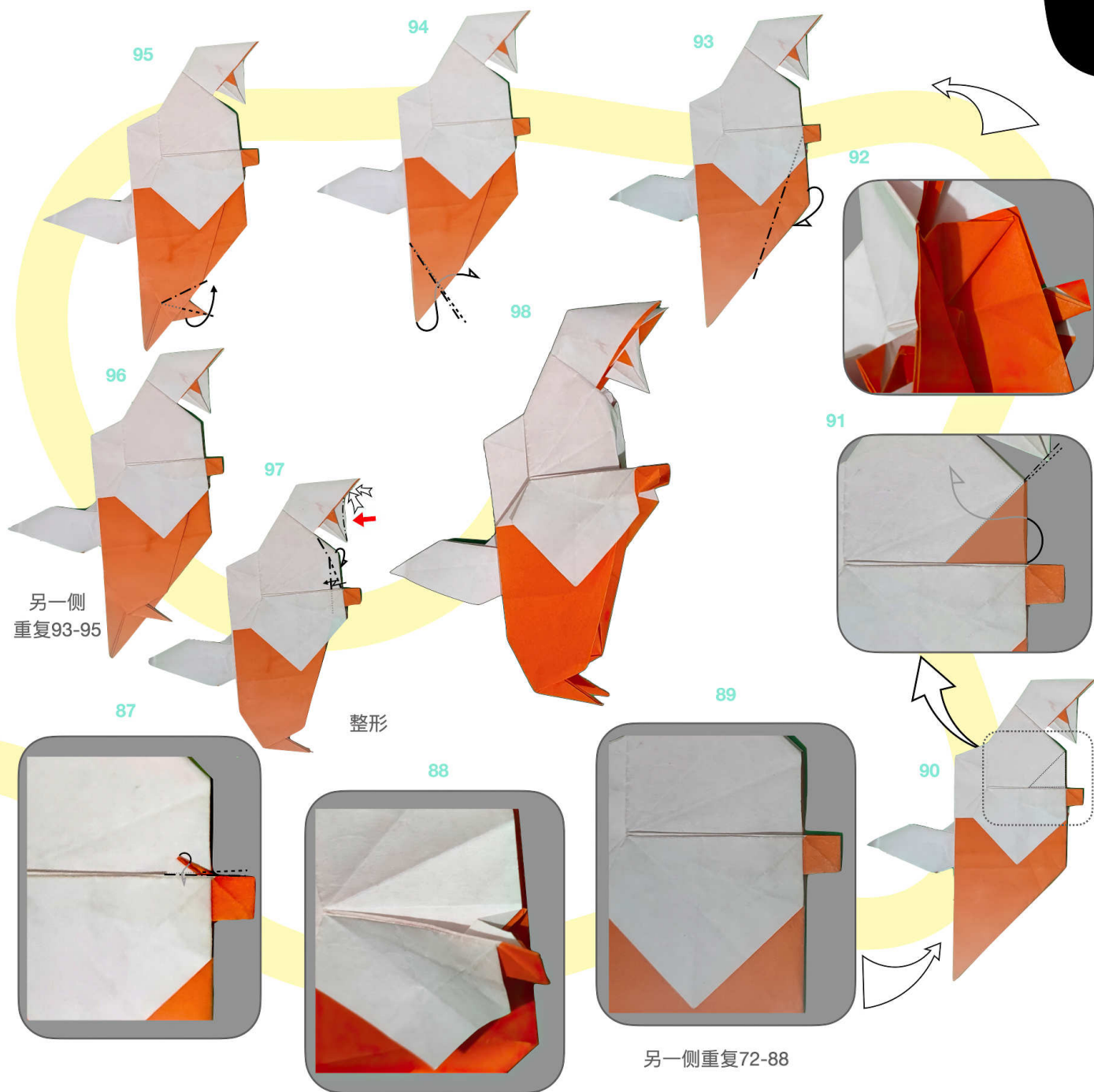

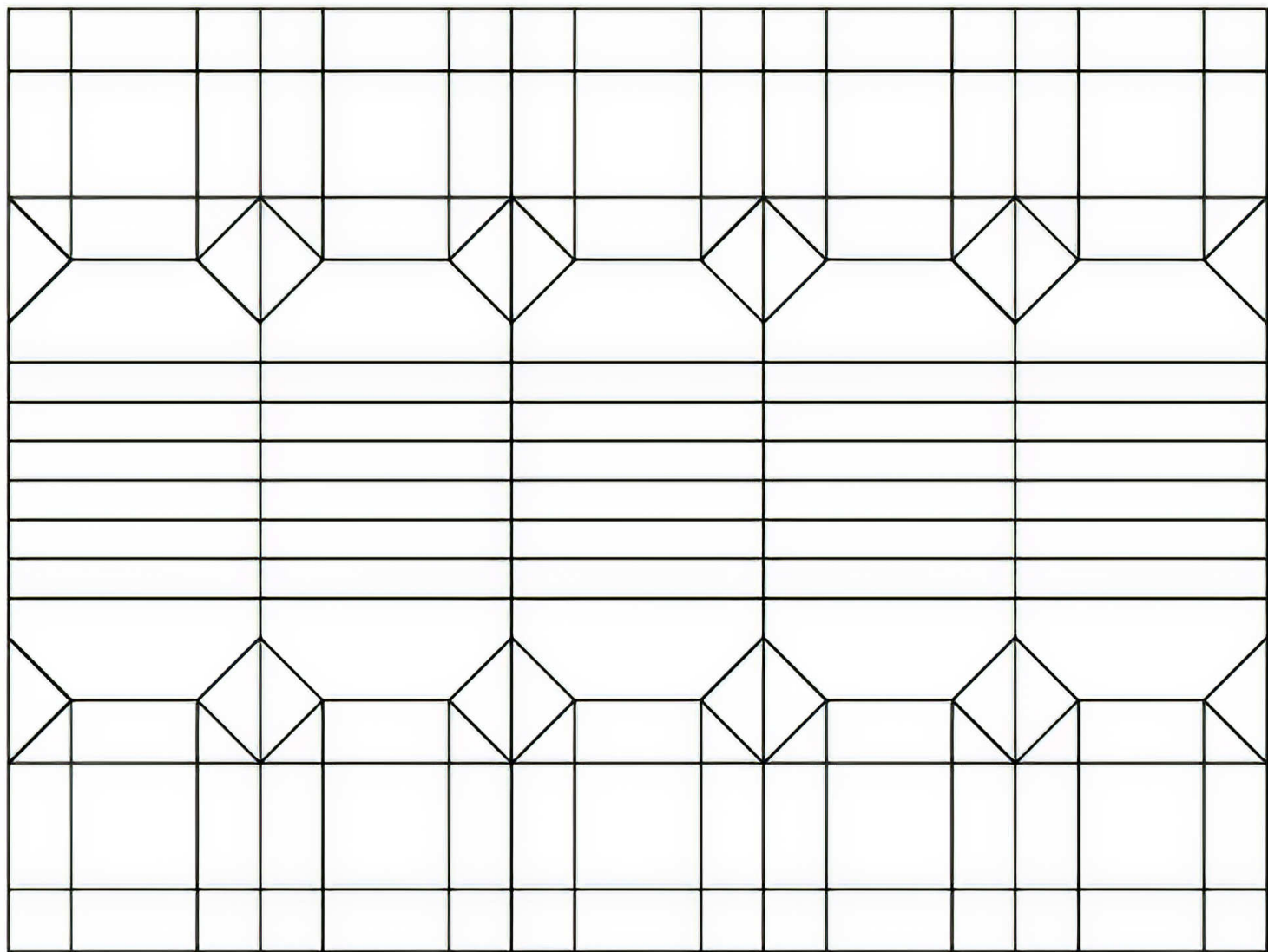

灯笼CP