

Chinese New Year Origami 2024

# 贺岁折纸

折纸艺术



# 贺岁折纸 甲辰版

Chinese New Year Origami 2024

Spring and Autumn Origami Club(SAOC)

2024

# 符号说明

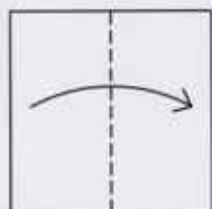

谷折  
Valley fold

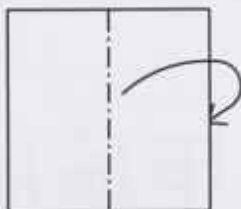

山折  
Mountain fold

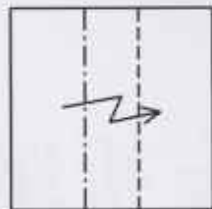

段折  
Pleat fold

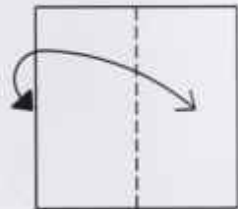

折出折痕  
Making a crease line

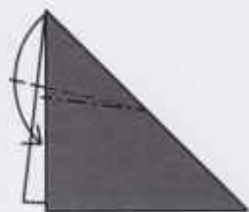

内翻折  
Inside-reverse fold

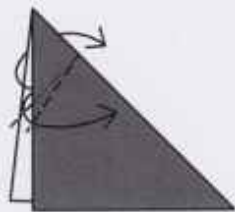

外翻折  
Outside-reverse fold

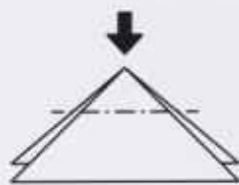

沉折  
Sink



下部分折叠后露出剩余部分  
Release bottom flap when making a fold



方向转换  
Rotation



翻转  
Turn paper over



放大图像  
A magnified view



视点  
The viewpoint



打开  
Open up



抽出  
Pull out



参考点  
Marked point



等分  
Division

Butterfly 铭钰

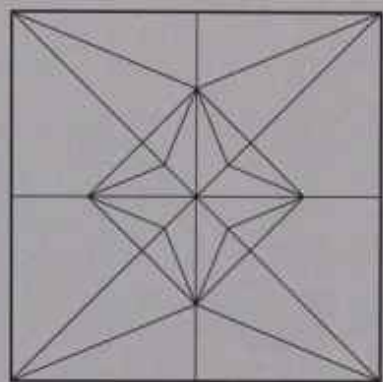

1



Bird 小鸟 5

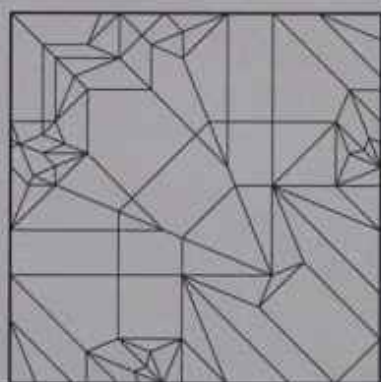

囍

17

Add Greater Joy

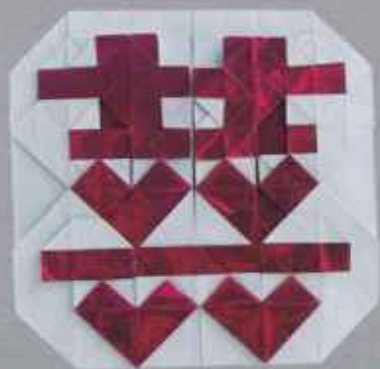
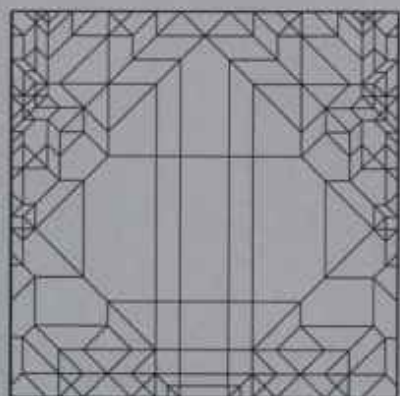

Dragon 飞龙

32

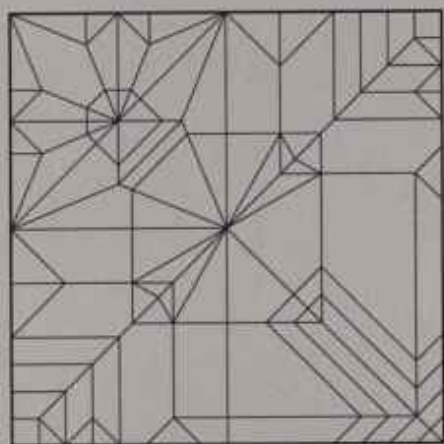
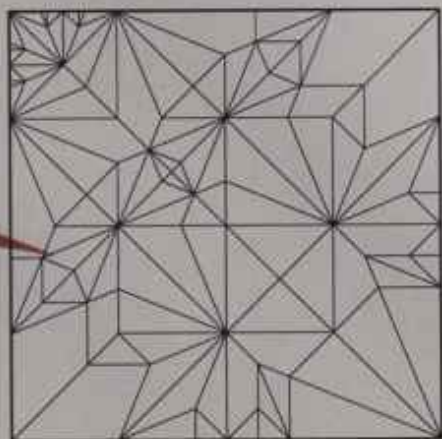

Racoon 浣熊 39



Panda 熊猫 46

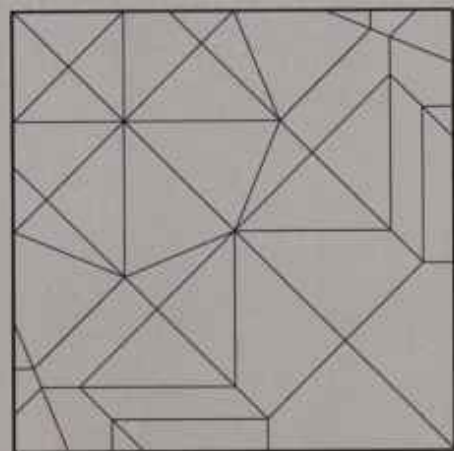

鸣蛇  
Singjing Snake

51

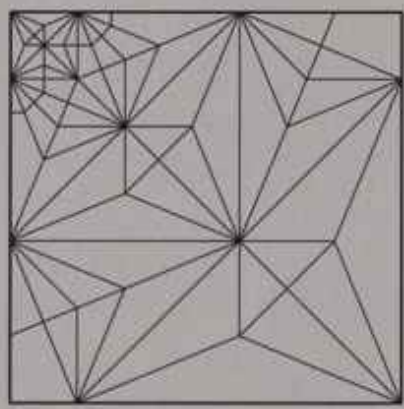

Mouse 耳鼠

57

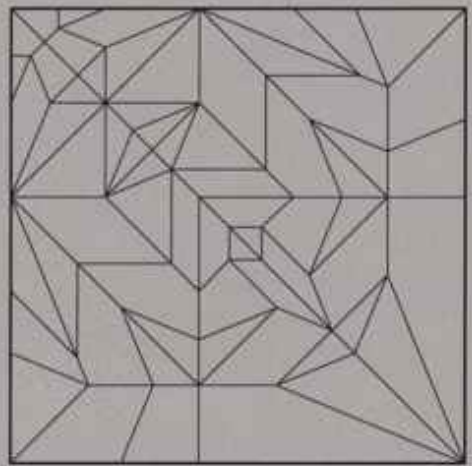

Hand 手

66

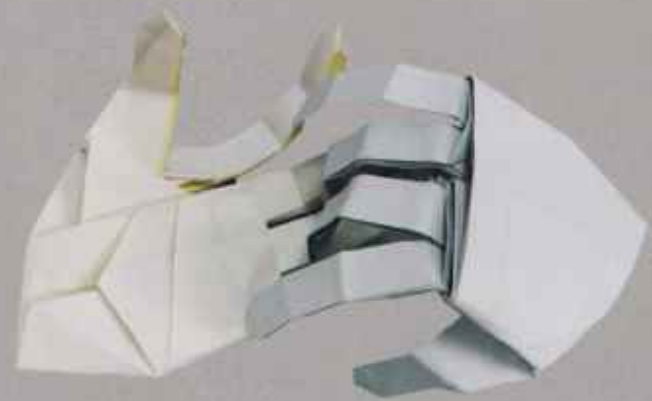
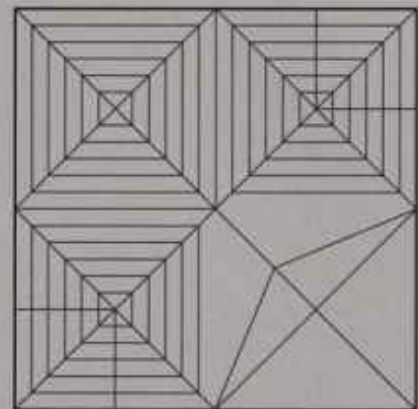



Pegasus 小天马

70

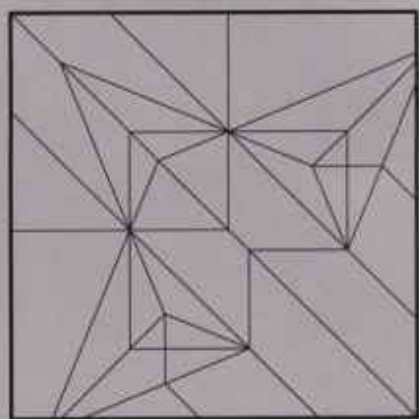

Ablabys Taenianotus 背带长绒魷 83

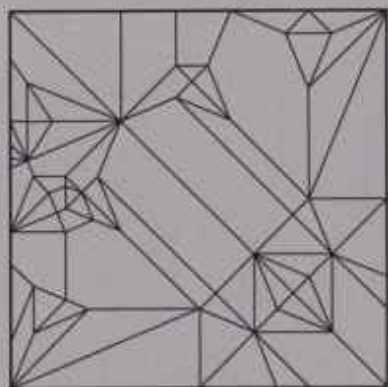

90

Manta 蝠鱝

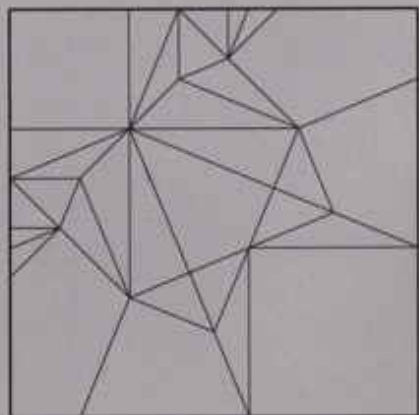

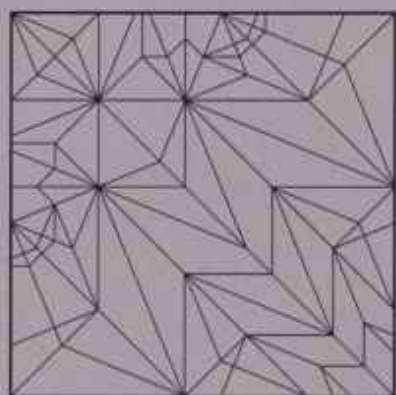

101

妖娆龙

Enchanting loong



Loong 龙

109

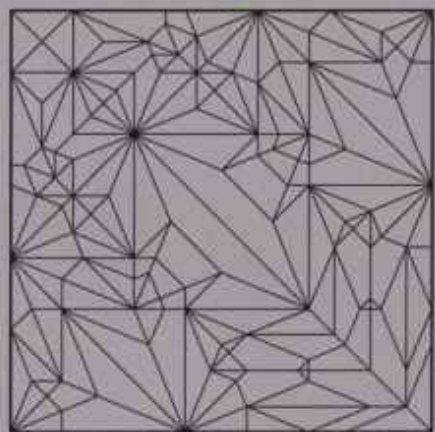

Loong 中国龙

122

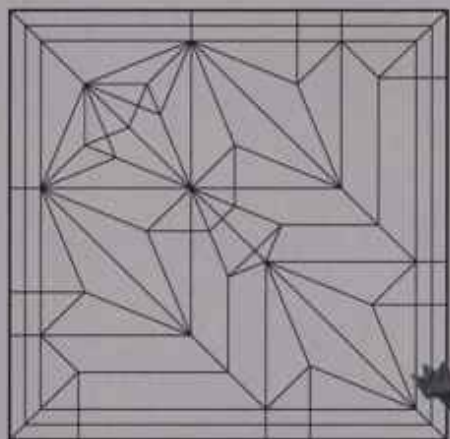



142

白银龙  
Dragon

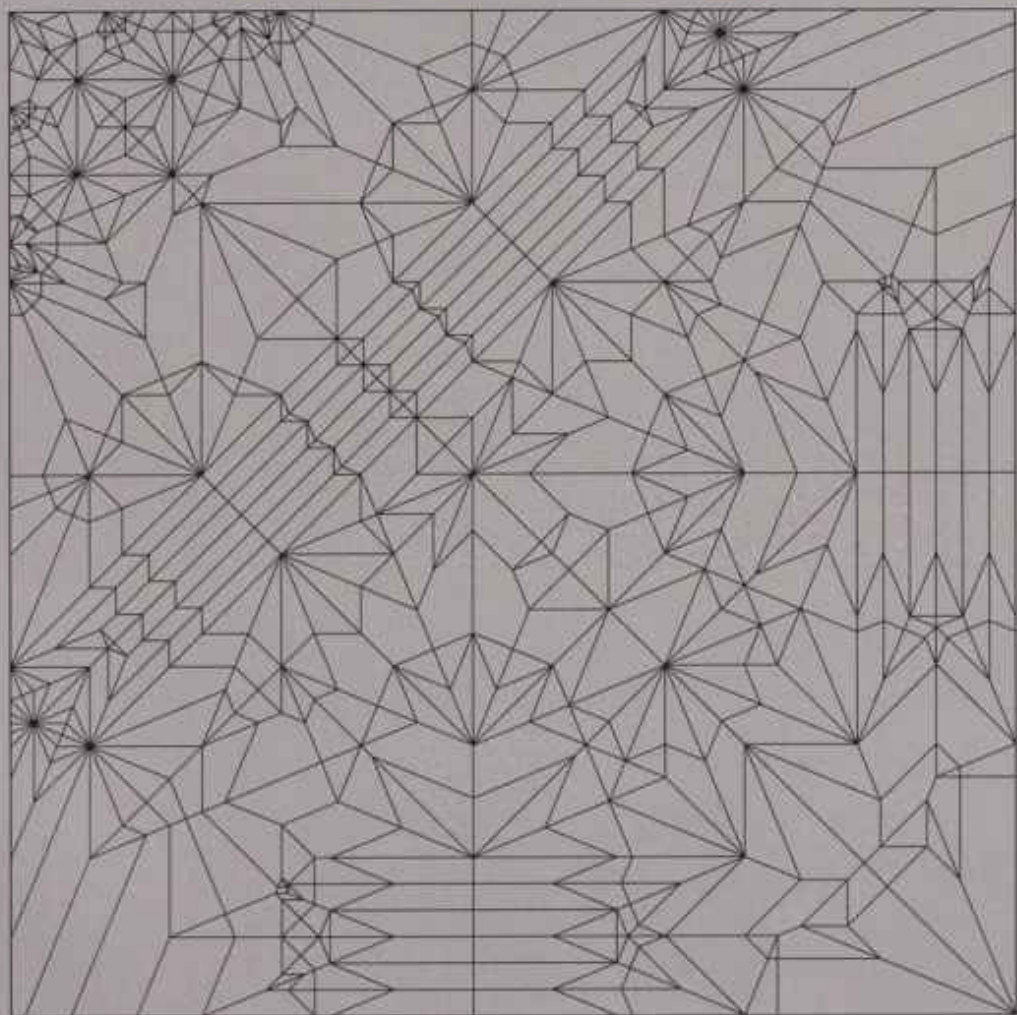

## 白银龙

本设计的命名灵感来自源自“白银比 ( $\sqrt{2}:1$ )”，基本型后肢与前肢、后爪与前爪的比均为为白银比，故命名为白银龙。

简化cp 如右侧图



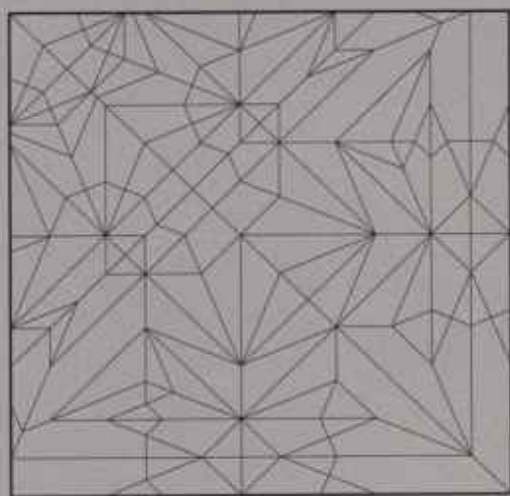

# 铭钰

Butterfly

设计/Designer  
孟婆 Mengpo

制图/Diagrams  
咕咕菜

03/2024

纸张大小/Paper Size  
15 x 15 cm 玉虫纸/kami

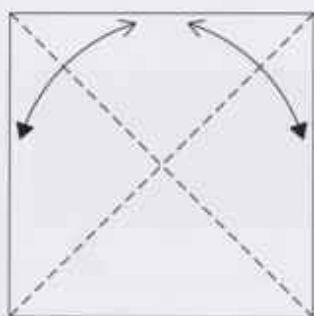
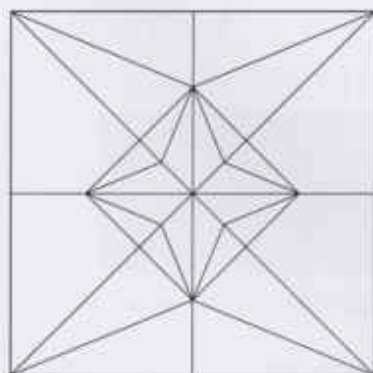
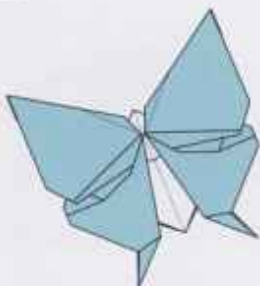

01. Fold then unfold 留下折痕

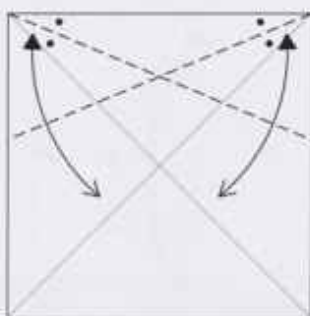

02. Fold along the angle bisectors and unfold. 沿角平分线留下折痕

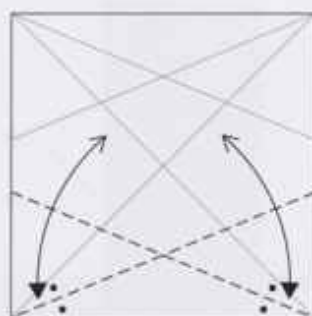

03. Fold along the angle bisectors and unfold. 沿角平分线留下折痕

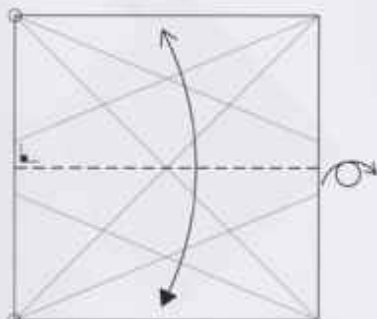

04. Fold then unfold, turn over 留下折痕后翻转

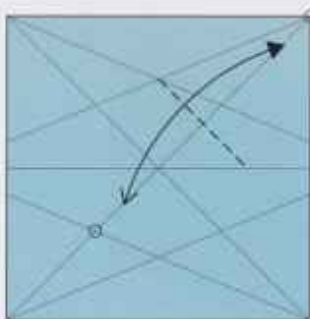

05. Fold then unfold. 留下折痕

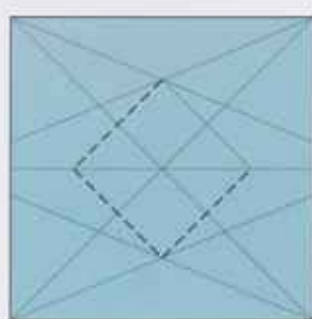

06. Fold then unfold, turn over 留下折痕后翻转

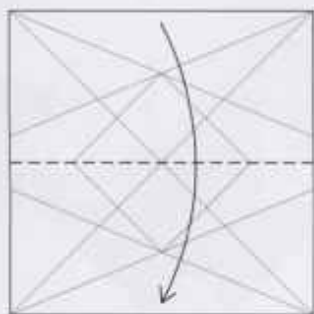

07. Fold then unfold 留下折痕



08. Fold then unfold 留下折痕



09. Fold then unfold 留下折痕

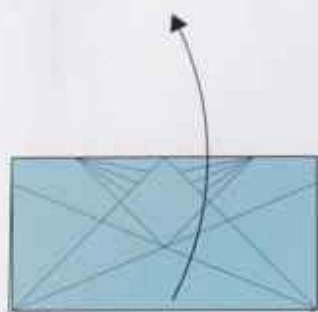

10. Unfold 展开

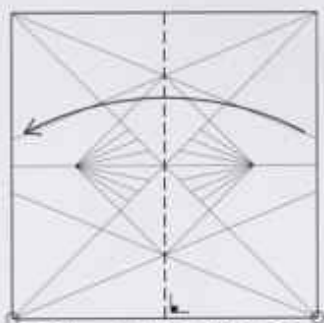

11. Valley-fold 沿谷线向右折疊

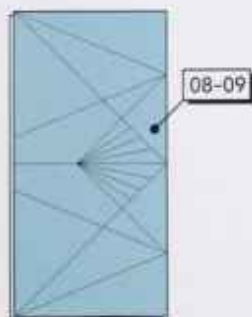

12. Repeat the step 8-9, 重复8-9步骤

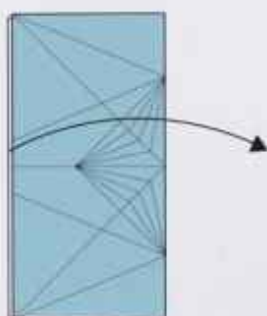

13. Unfold 展开

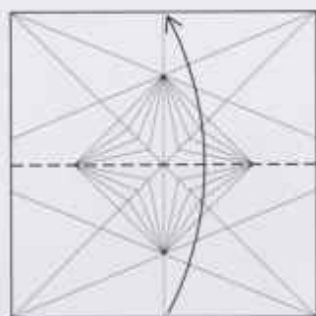

14. Valley-fold 沿谷线向上折疊



15. Squash-fold 撑开压折 注意虚线不折

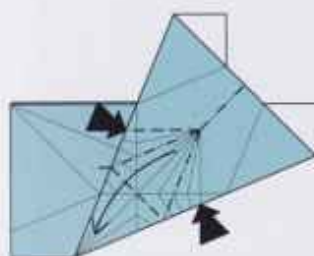

16. Petal fold 花瓣折 变形 注意折痕

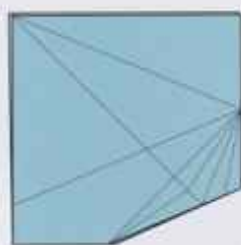

17. Rotate 45 degrees 旋转45度

45°

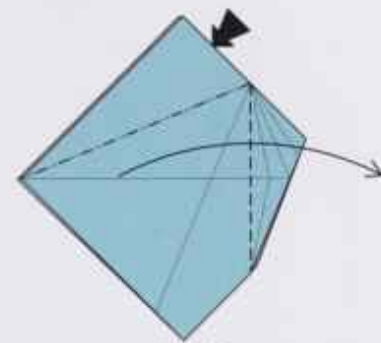

18. Swivel-fold. 旋转折

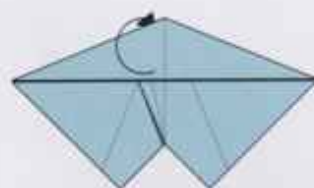

19. Outside reverse-fold 外翻折

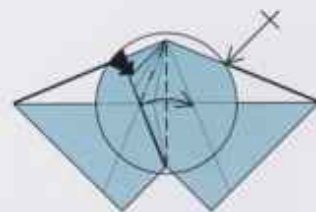

20. Spread sink 延展沉折

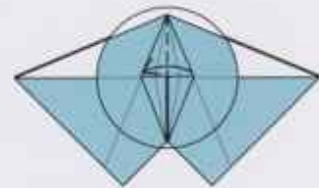

21. Valley-fold 向左谷折

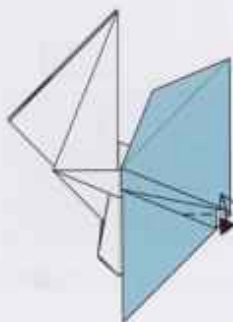

34. Fold then unfold 留下折痕

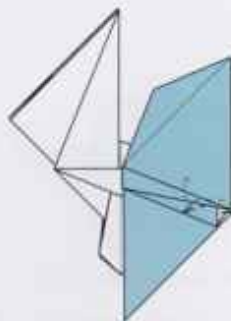

35. Swivel-fold. 旋转折



36. Mountain-fold 向内部山折



37. Mountain-fold 向内部山折

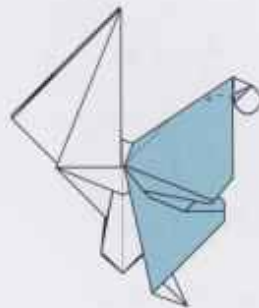

38. Valley-fold 向内谷折



39. Fold then unfold 留下折痕

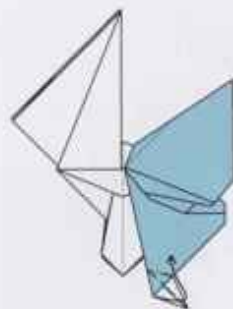

40. Swivel-fold. 旋转折

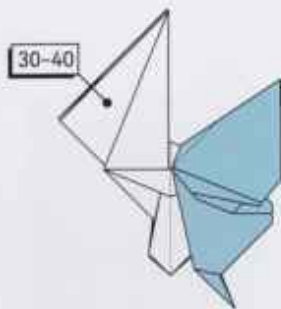

41. Repeat step 30-40 重复步骤



42. Turn over 翻到背面

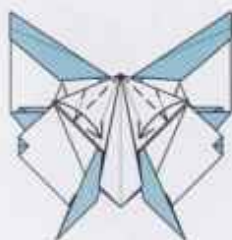

43. Swivel-fold. 旋转折



44. Turn over 翻到背面



45. 完成 Complete

# 折纸小鸟

Origami bird

设计/Designer  
陈晓 Chen Xiao

制图/Diagrams  
柒柒

纸张大小/Paper Size  
35 x 35cm 教育折纸

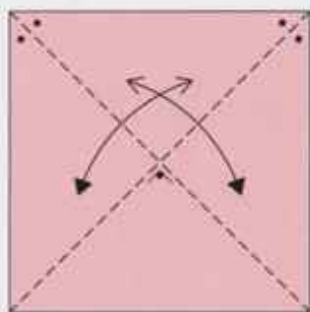
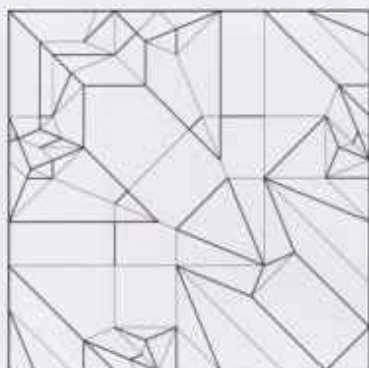

1. Fold along the diagonals and unfold.  
沿对角线留下折痕

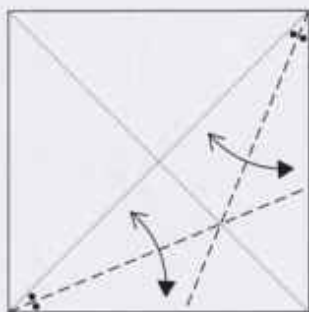

2. Fold along the angle bisectors and unfold.  
沿角平分线留下折痕

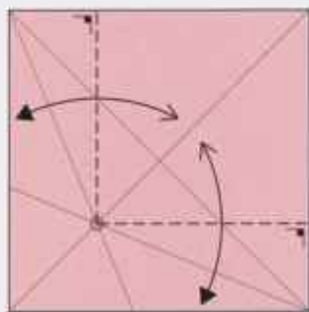

3. Fold then unfold 留下折痕

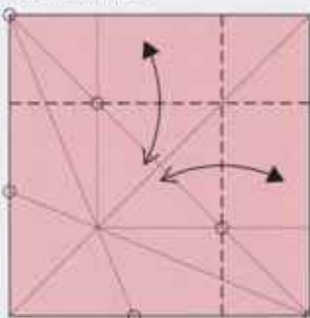

4. Fold then unfold 留下折痕

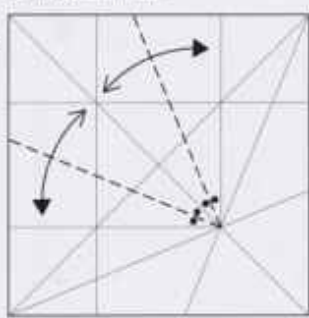

5. Fold along the angle bisectors and unfold.  
沿角平分线留下折痕

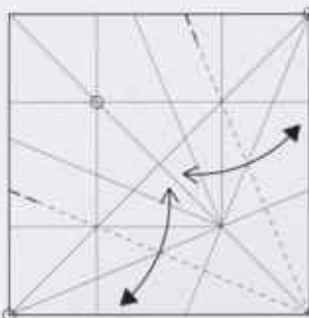

6. Fold along the angle bisectors and unfold.  
沿角平分线留下折痕

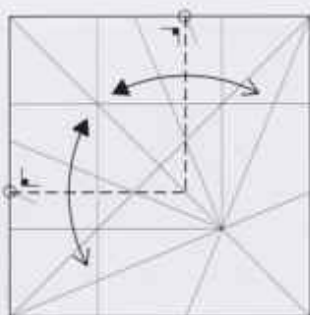

7. Fold then unfold 留下折痕

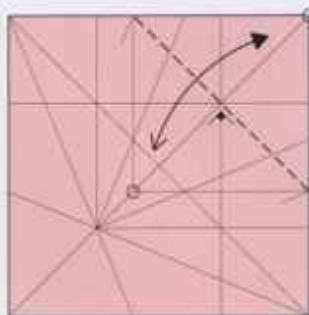

8. Crease according to the marked points.  
依参考点留下折痕

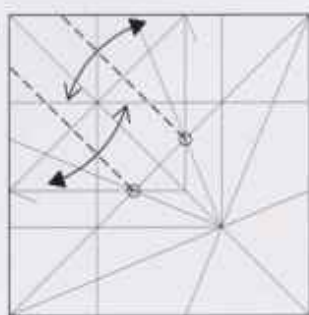

9. Fold then unfold 留下折痕

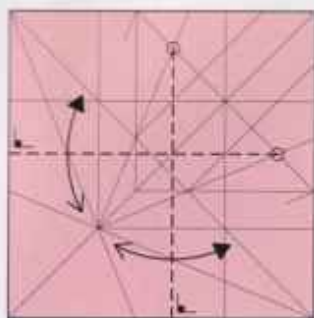

10. Fold then unfold 留下折痕

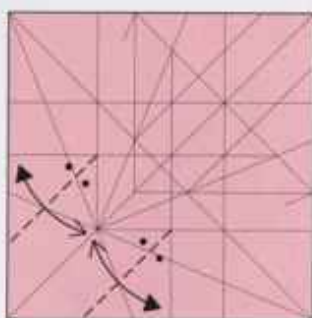

11. Fold then unfold 留下折痕

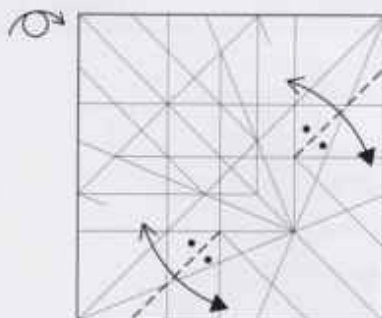

12. Fold then unfold 留下折痕

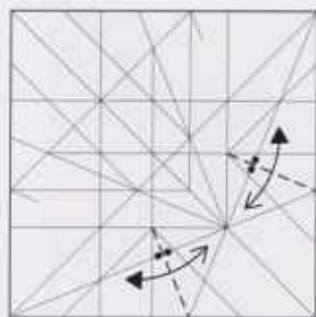

13. Fold then unfold 留下折痕

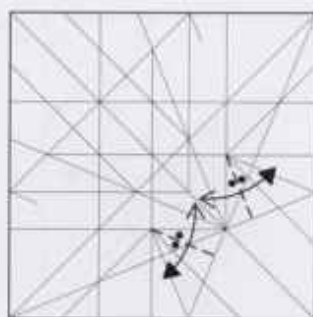

14. Fold then unfold 留下折痕

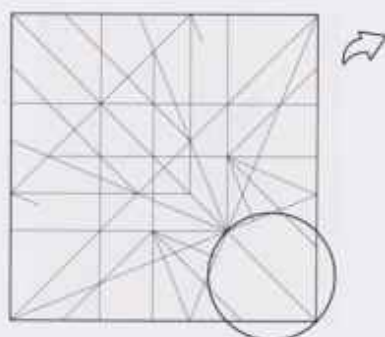

15. Zoom in 放大局部视角

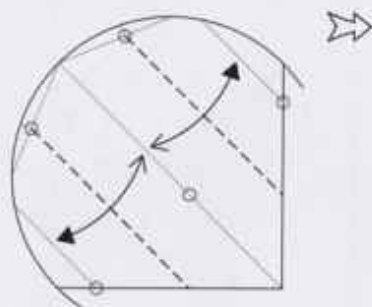

16. Fold then unfold 留下折痕



17. Fold then unfold 留下折痕

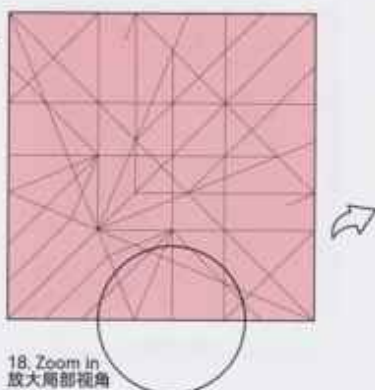

18. Zoom in 放大局部视角

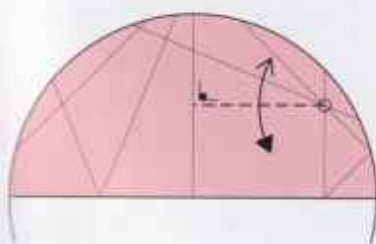

19. Fold then unfold 留下折痕

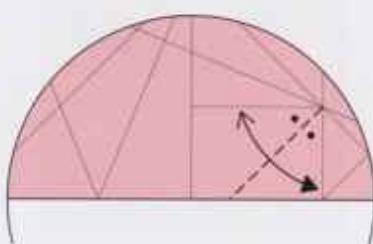

20. Fold then unfold 留下折痕

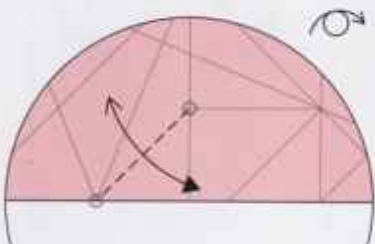

21. Fold then unfold 留下折痕



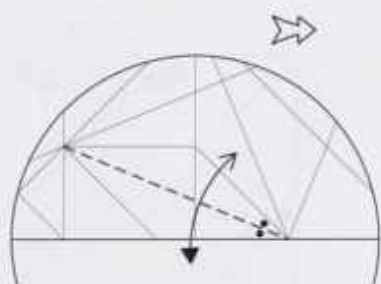

22. Fold then unfold 留下折痕

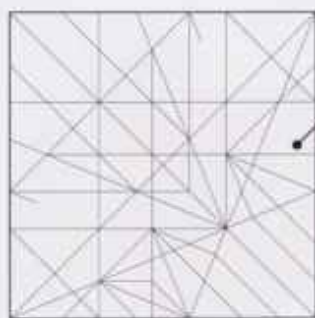

23. Repeat the step 19-22 另一側重複19-22

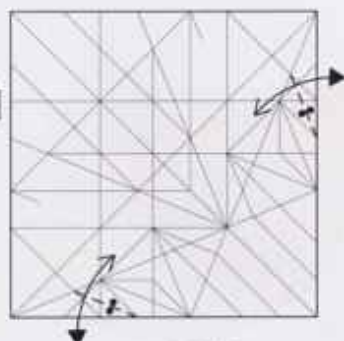

24. Fold then unfold 留下折痕

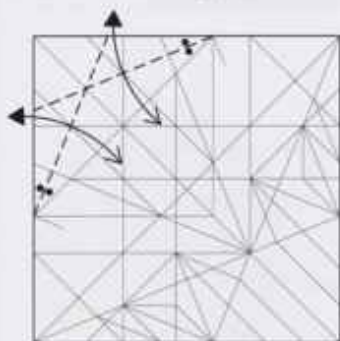

25. Fold then unfold 留下折痕

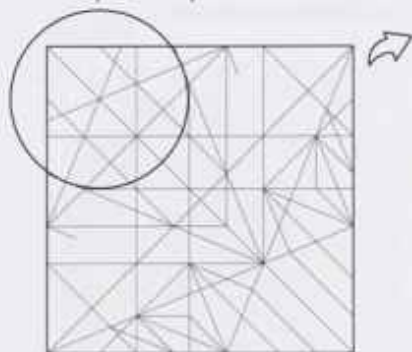

26. Zoom in 放大局部視角

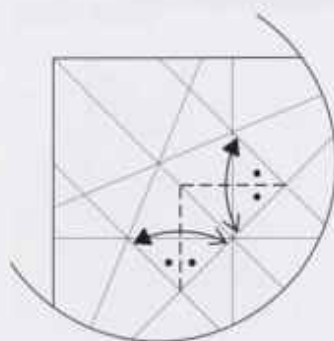

27. Fold then unfold 留下折痕

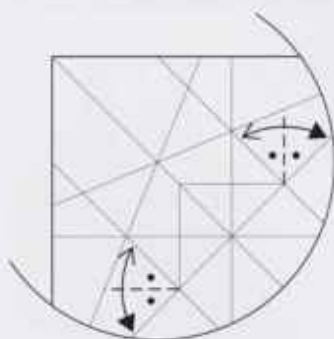

28. Fold then unfold 留下折痕

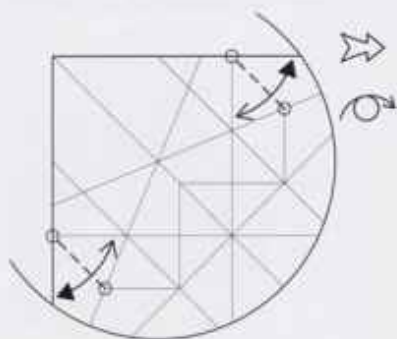

29. Fold then unfold 留下折痕

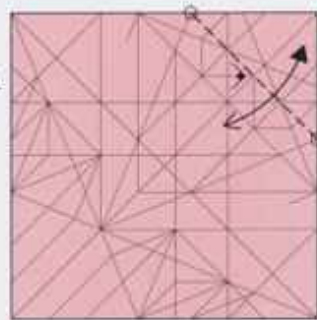

30. Fold then unfold 留下折痕



31. Valley-fold 向上谷折

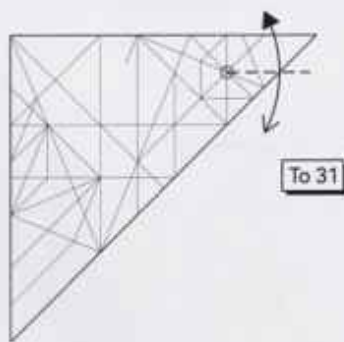

32. Fold then unfold to 31 留下折痕并展开到31步骤

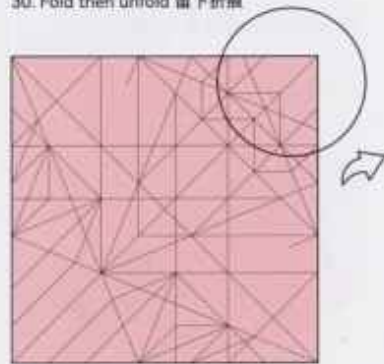

33. Zoom in 放大局部視角

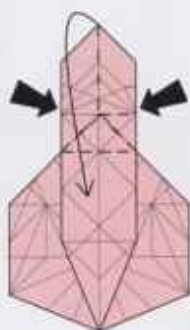

46. Petal-fold 花瓣折, 此时模型不压平

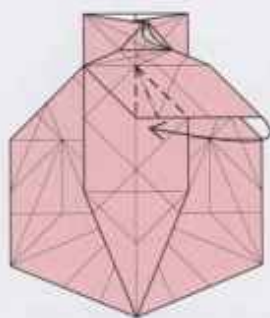

47. Collapse according to the creases. 按峰谷聚合

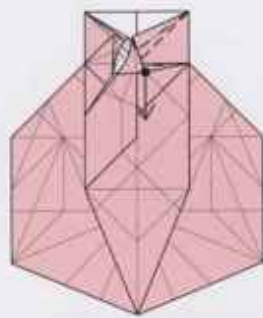

48. Collapse according to the creases. 按峰谷聚合 右侧压平

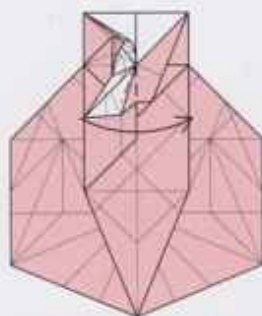

49. Valley-fold 向右谷折

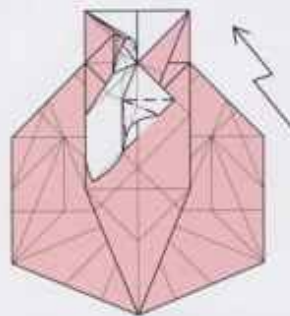

50. Pleat-fold 段折

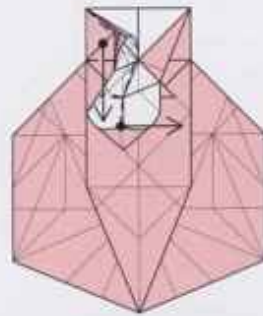

51. Collapse according to the creases. 按峰谷聚合并压平



52. Open-sink 开放沉折

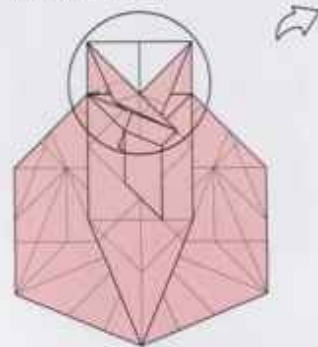

53. Zoom in 放大局部视角

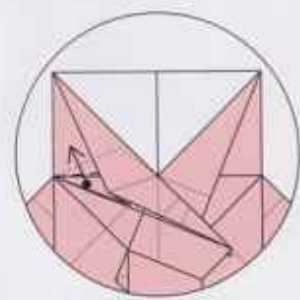

54. Valley-fold the inner layer 谷折内部纸层参考虚线位置



55. Valley-fold 谷折

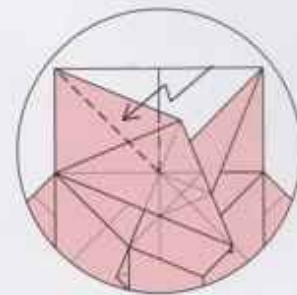

56. Pleat-fold, not flat 段折此时模型不压平

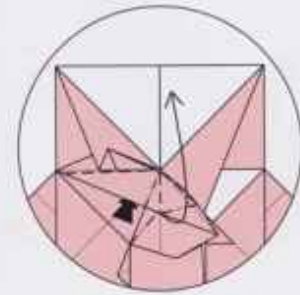

57. Collapse according to the creases. 按峰谷聚合并压平

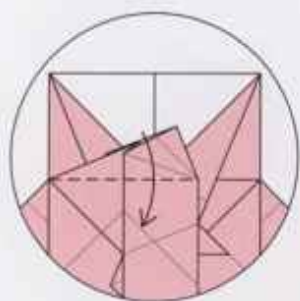

58. Collapse according to the creases.  
按峰谷聚合

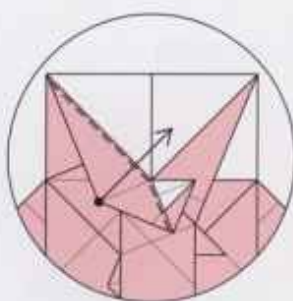

59. Valley-fold not flat 此时模型不压平

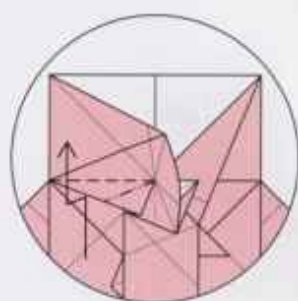

60. Pleat-fold 谷折

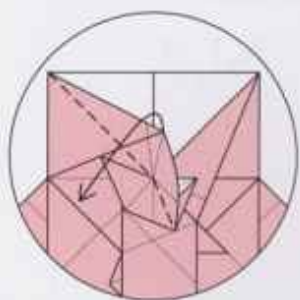

61. Valley-fold 谷折压平

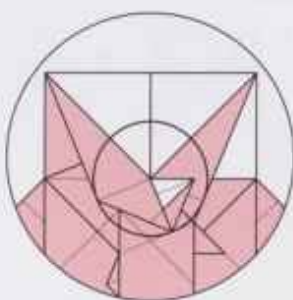

62. Zoom in 放大局部视角

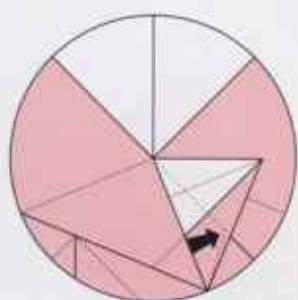

63. Pull out the inner layer 拉出内部纸层

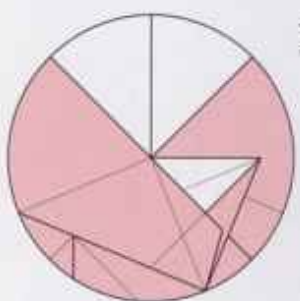

64. to step 59 返回到59步的放大视角

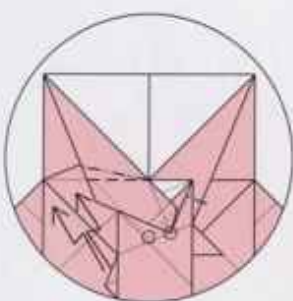

65. Crimp. 双重叠折

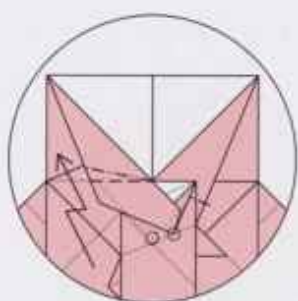

66. Pleat-fold 叠折

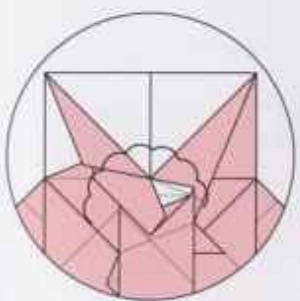

67. Change view 忽略表层的小五边形

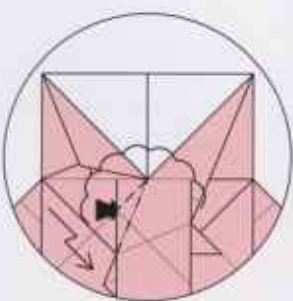

68. Pleat-fold 下一步结束透视

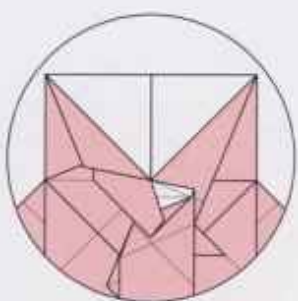

69. Zoom out 缩小视角



70. Valley-fold 谷折

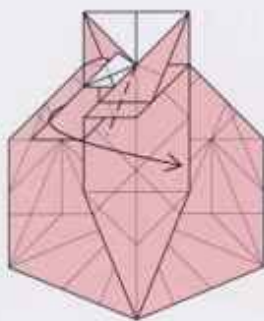

71. Valley-fold 谷折

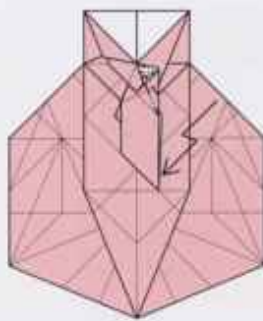

72. pleat-fold 段折

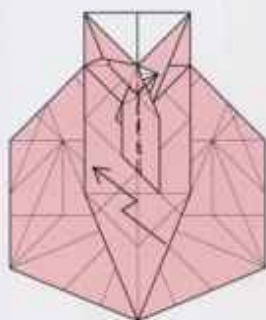

73. Pleat- fold 段折

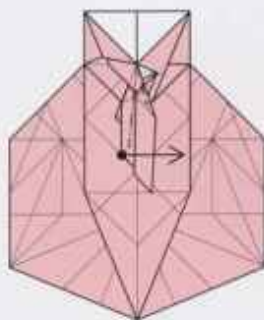

74. Rub the paper layer 揉开纸层 参考下一步

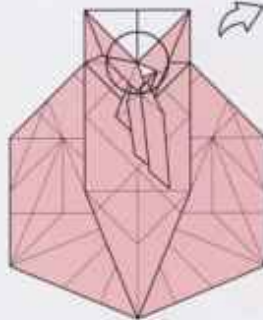

75. Zoom in 放大局部视角

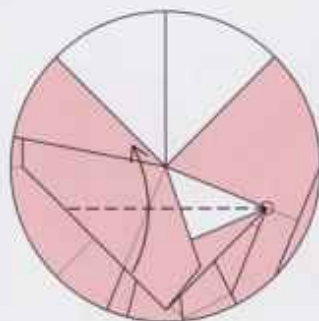

76. Valley-fold 谷折

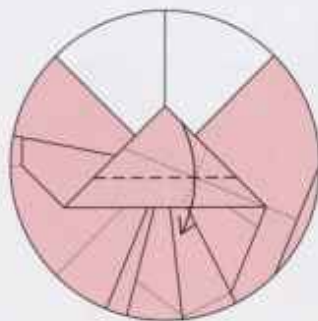

77. Valley-fold 谷折

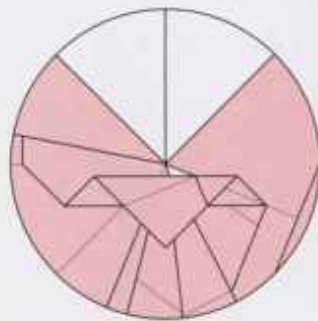

78. Zoom out 缩小局部视角



79. Turn over 翻转

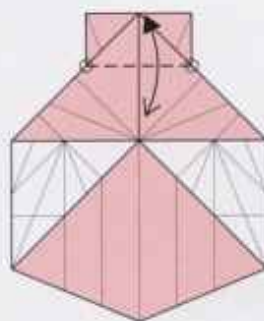

80. Fold then unfold 留下折痕

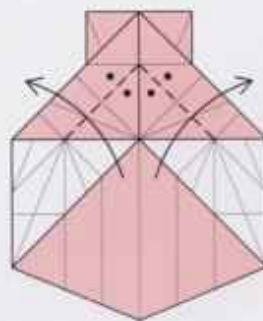

81. Valley-fold 谷折

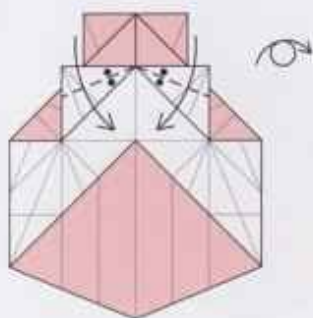

82. Valley-fold 谷折并翻折

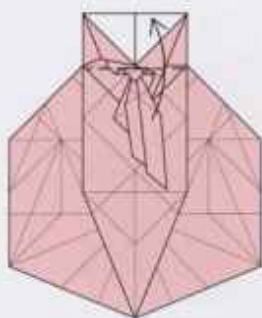

83. Valley-fold 谷折

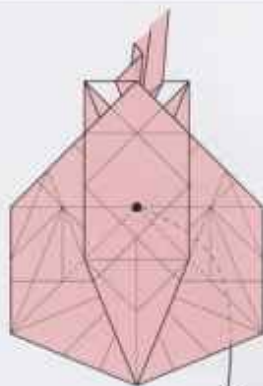

84. Lift the back layer 此时模型不压平

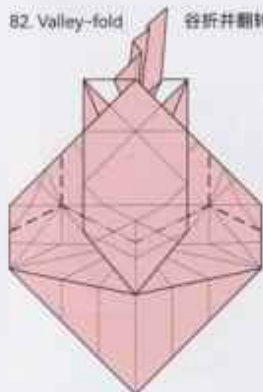

85. Collapse according to the creases, not flat 按缝谷聚合此时模型不压平

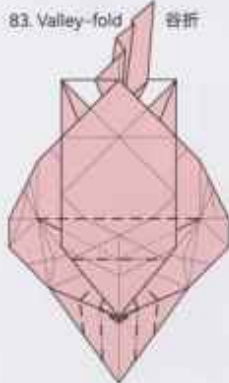

86. Collapse according to the creases, not flat 按缝谷聚合此时模型不压平

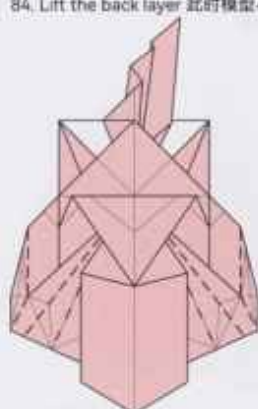

87. Collapse according to the creases. 按缝谷聚合并压平

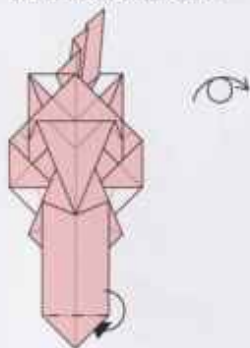

88. Mountain-fold 山折

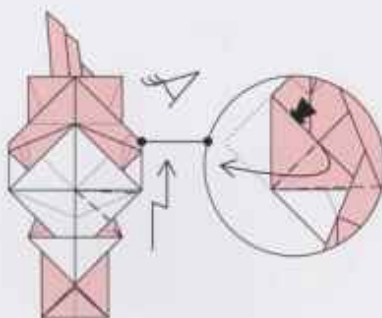

89. Pleat-fold 段折 (变换视角)

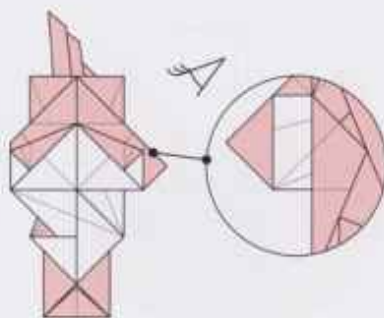

90. the back view 背部视角



91. Valley-fold 谷折

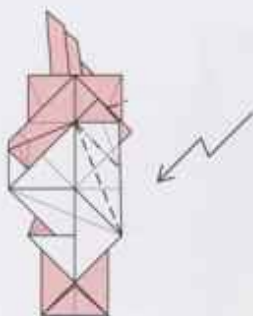

92. Pleat-fold 段折



93. Swivel-fold 旋转折叠

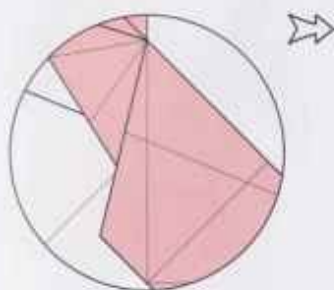

106. Zoom out 缩小局部视角

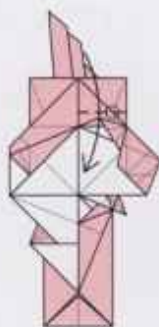

107. Valley-fold 谷折

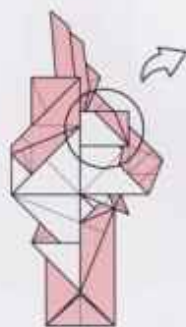

108. Zoom in 放大局部视角

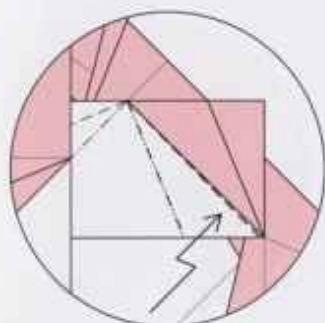

109. Pleat-fold 殿折

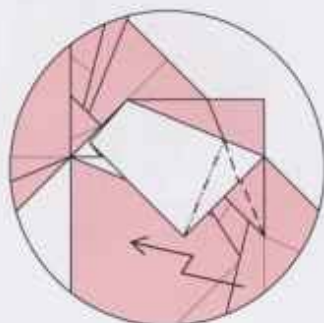

110. Pleat-fold 殿折

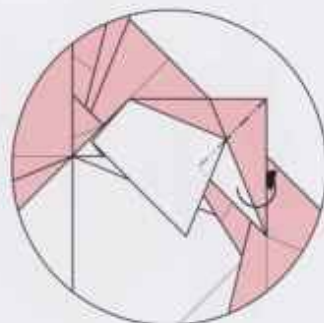

111. Mountain-fold 山折

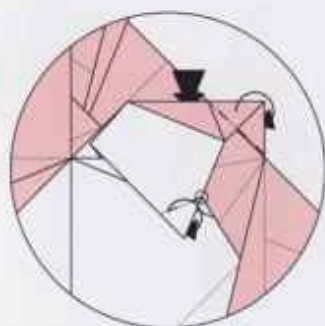

112. Mountain-fold 山折

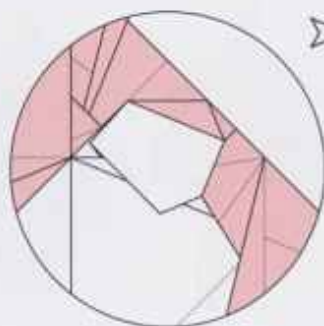

113. Zoom out 缩小局部视角

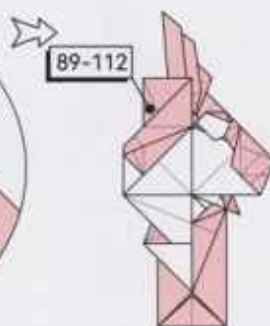

114. repeat step 89-112 另一侧  
重复89-112步骤

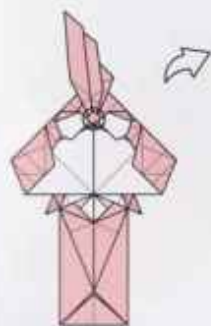

115. Zoom in 放大局部视角

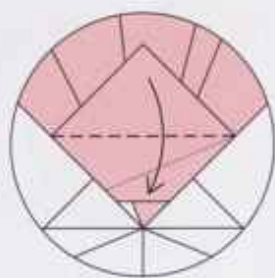

116. Valley-fold 谷折

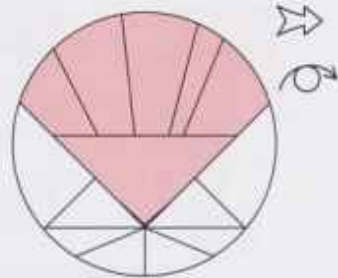

117. Zoom out then turn over  
缩小局部视角并翻转

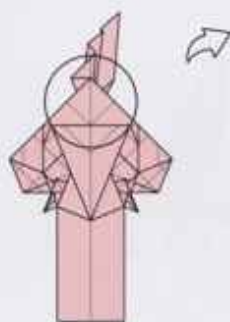

118. Zoom in 放大局部视角

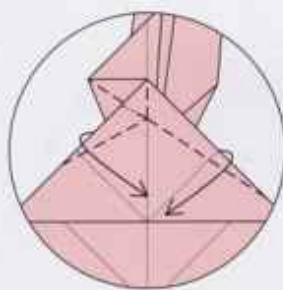

119. Collapse according to the creases. 按峰谷聚合

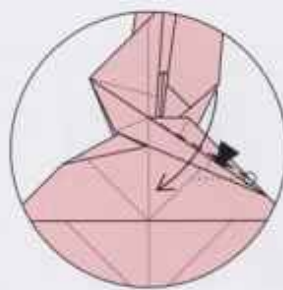

120. Valley-fold 谷折

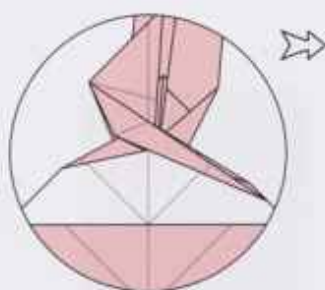

121. Zoom out 缩小局部视角



122. Lift up the layer. Collapse according to the creases. 按峰谷聚合撑开纸层，顺势向右拉开然后压平



123. Valley-fold 谷折



124. Fold then unfold 留下折痕



125. Fold then unfold 两层纸同时谷折



126. Valley-fold 谷折

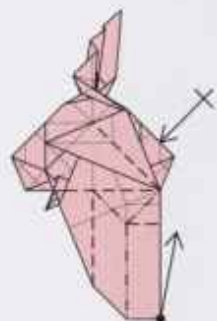

127. Collapse according to the creases, repeat the back layer, not flat 左右两侧同时按峰谷聚合,此时模型不平

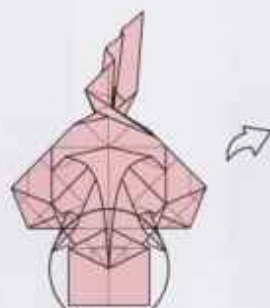

128. Zoom in 放大局部视角

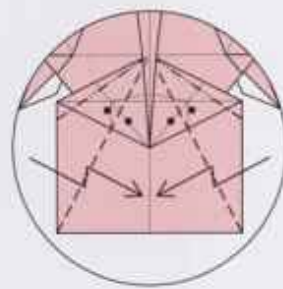

129. Pleat-fold 段折

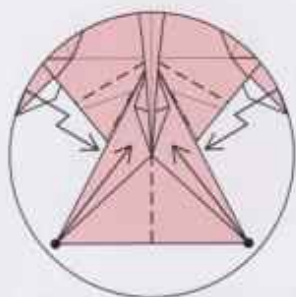

130. Pleat-fold 段折

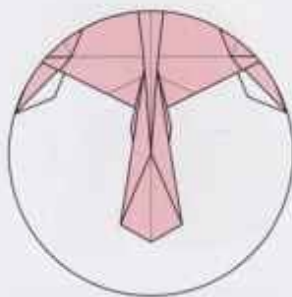

131. Zoom out 缩小局部视角

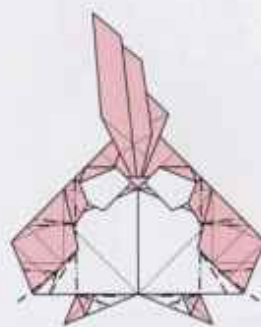

132. 3D. 立体化并添加眼睛和腮红



133. Complete -



# 喜字 Add Greater Joy

Designed:

五迷 (Mi Wu) 9/2023

Paper Size: 35 x 35 cm

用纸大小: 35 x 35 cm

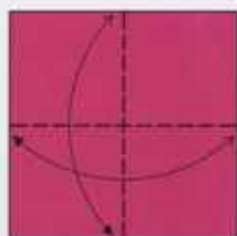
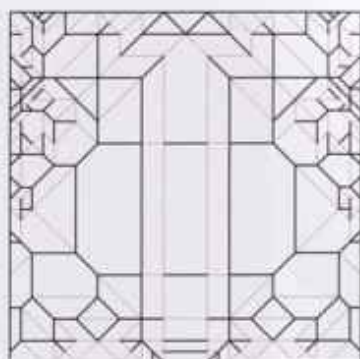
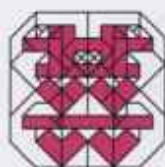

1

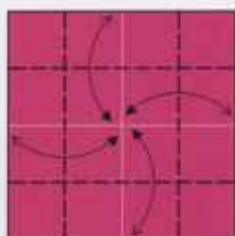

2

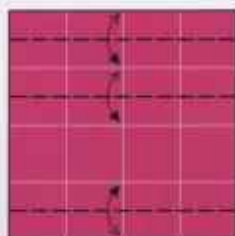

3

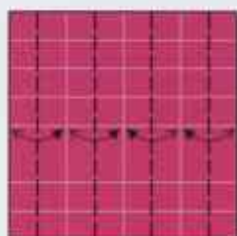

4

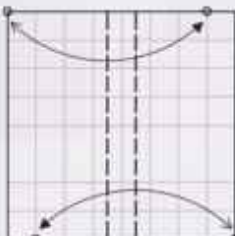

5

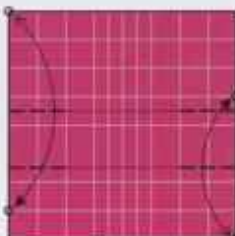

6

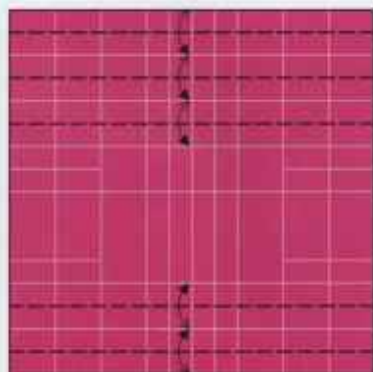

7

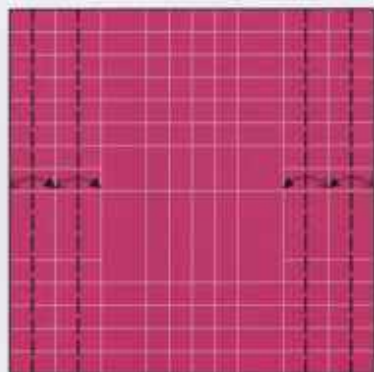

8

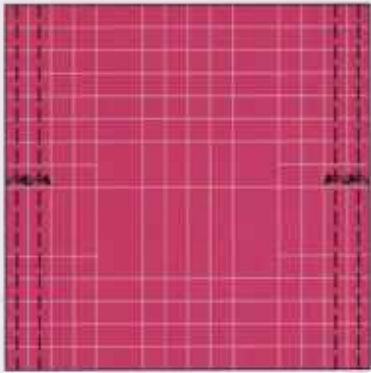

9

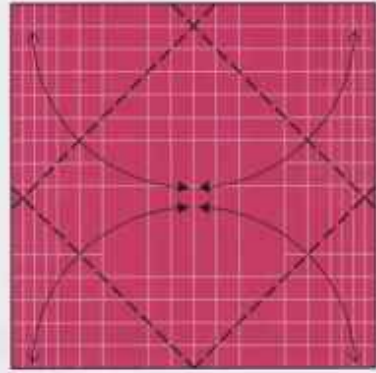

10

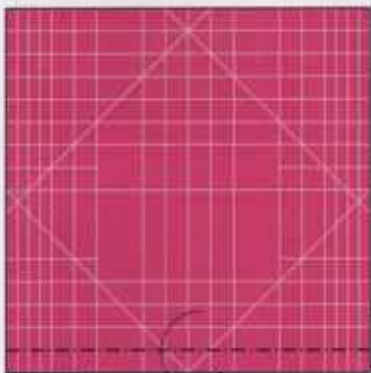

9

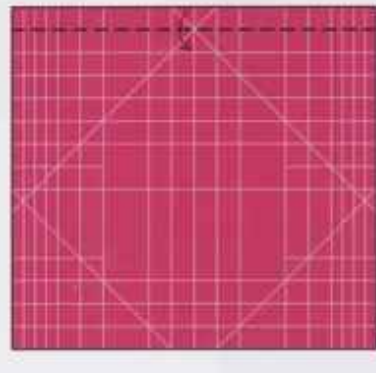

10

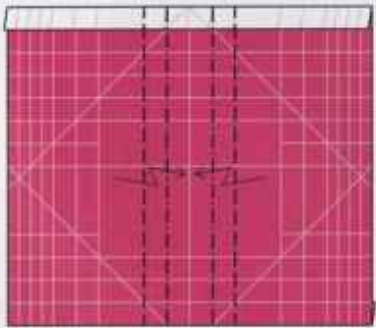

13

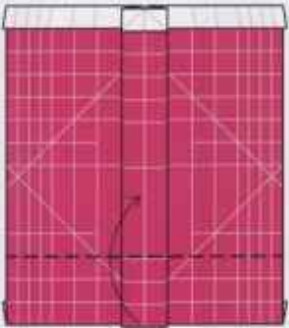

14



15

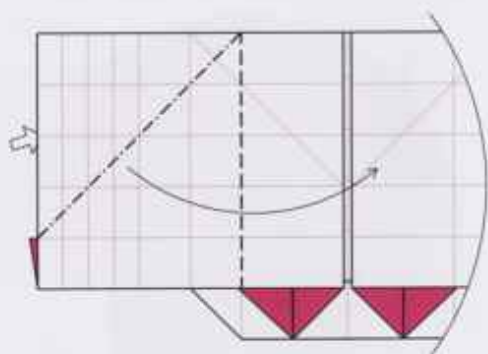

32

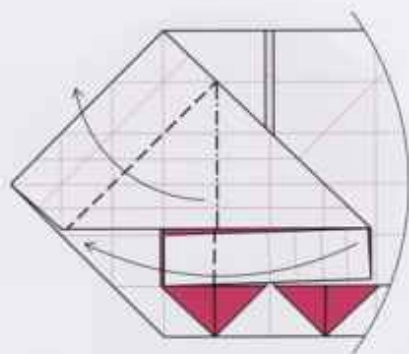

33

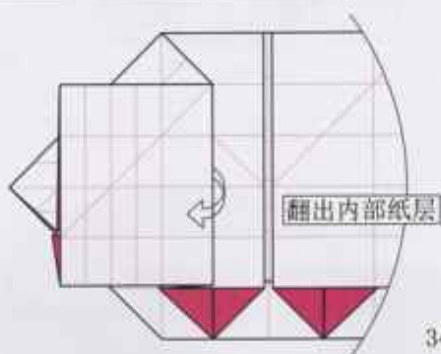

34

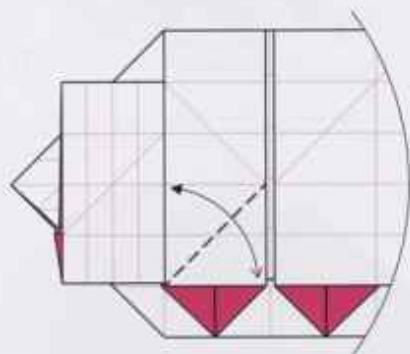

35

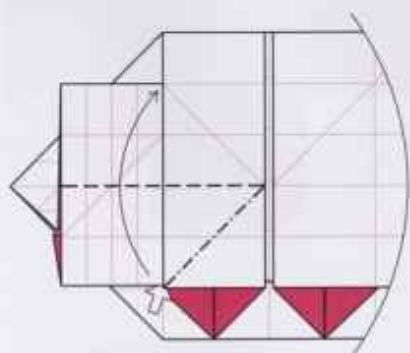

36

① 立体过程图

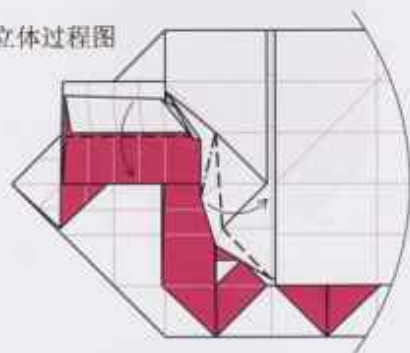

37

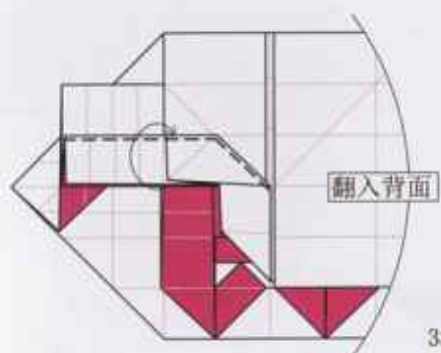

38

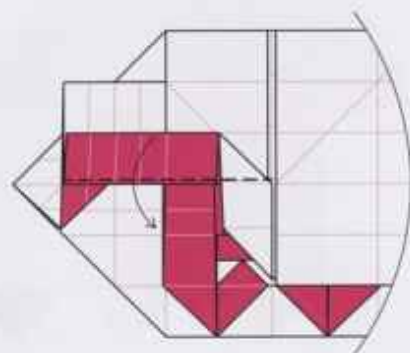

39

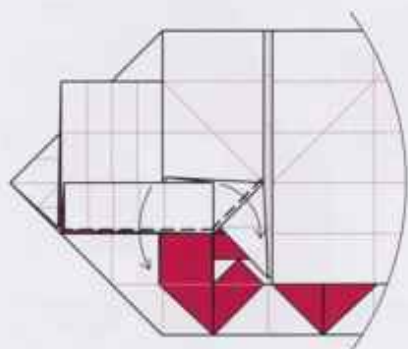

40

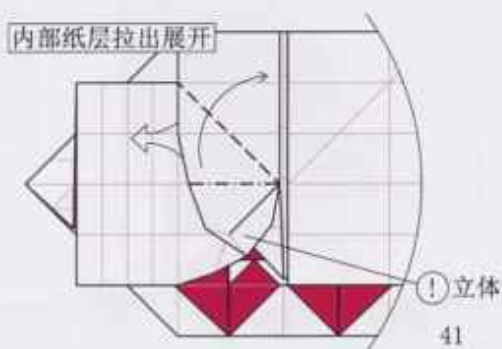

41

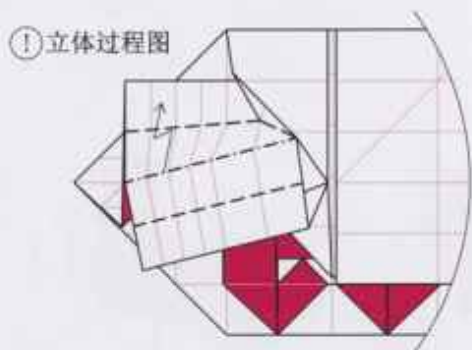

42

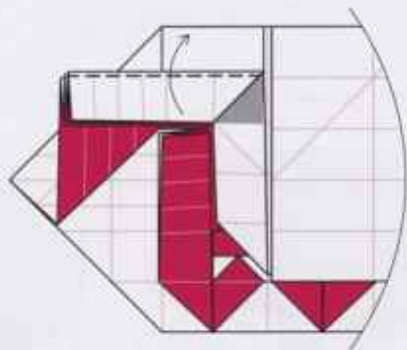

43

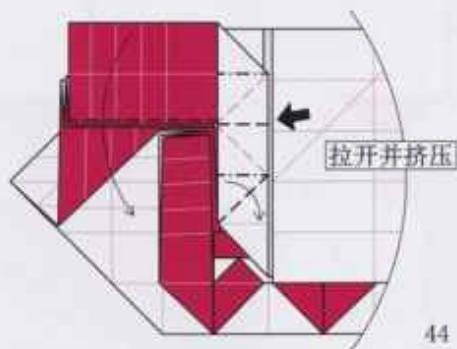

44

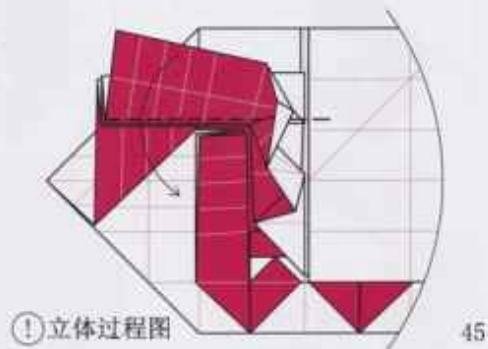

45

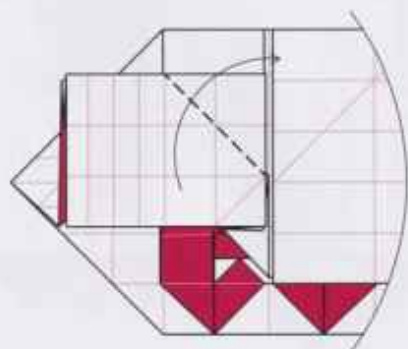

46

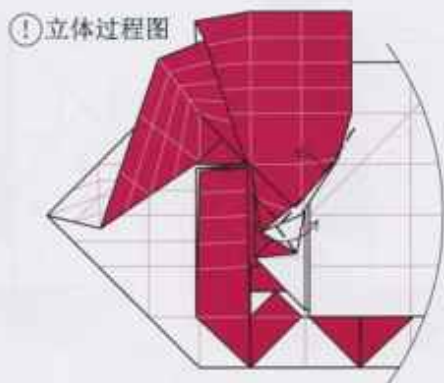

47

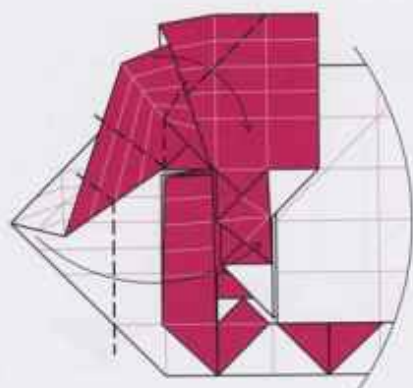

① 立体过程图

48

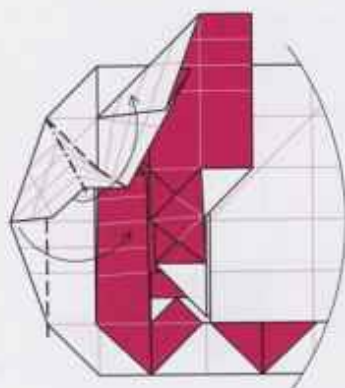

① 立体过程图

49

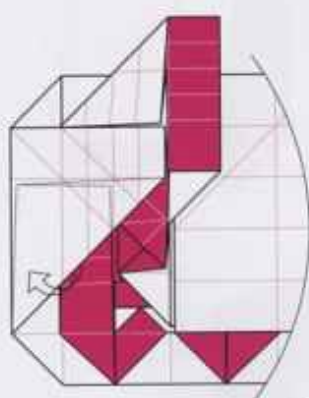

翻出内部纸层

50

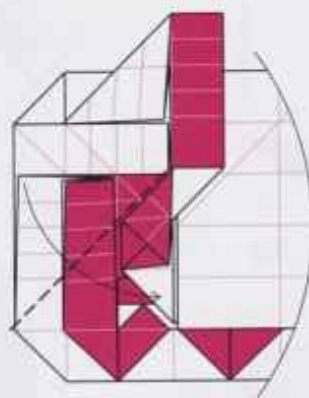

51

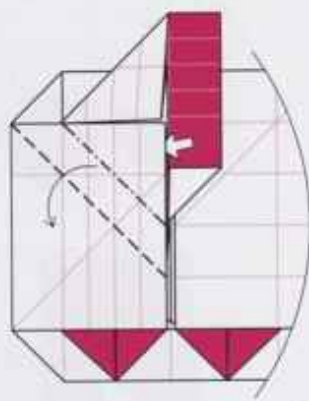

52

① 立体过程图

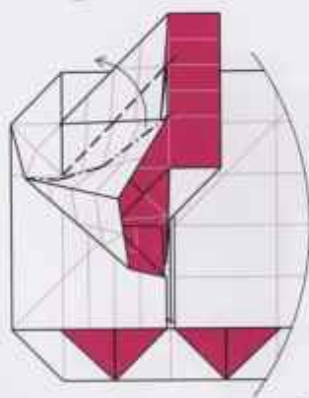

53

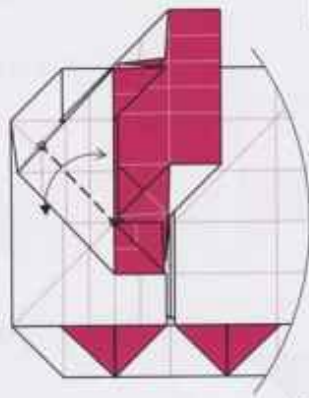

54

内部纸层拉出展开

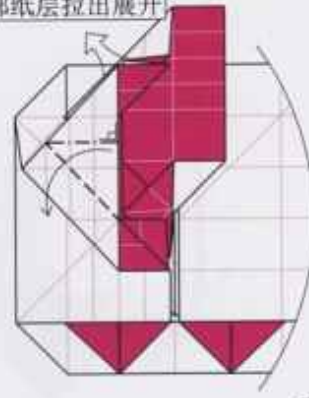

55

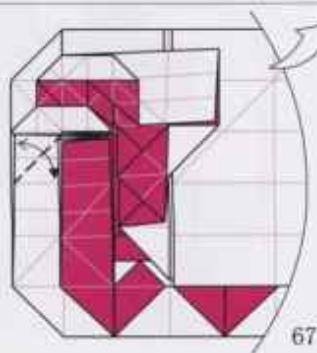
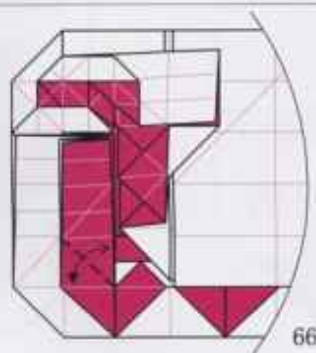
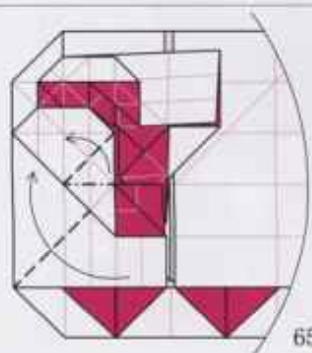
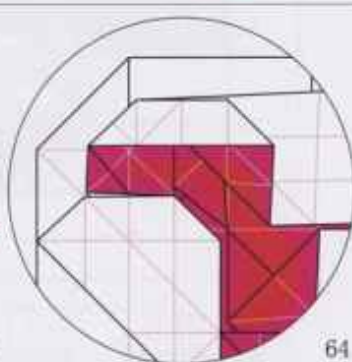
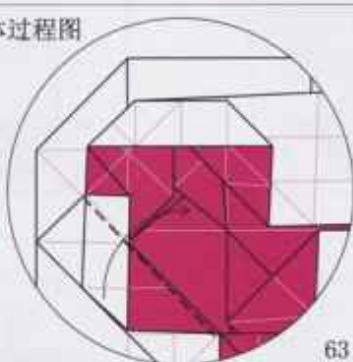
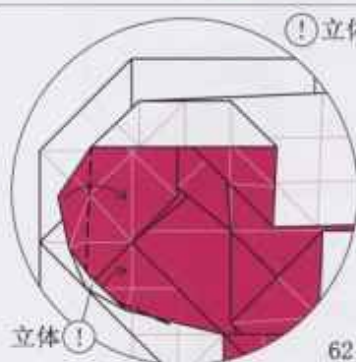
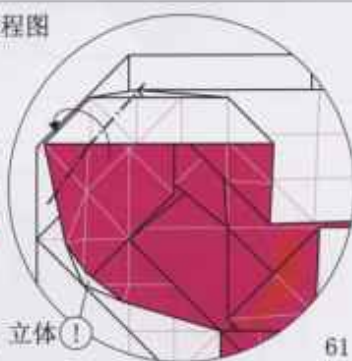
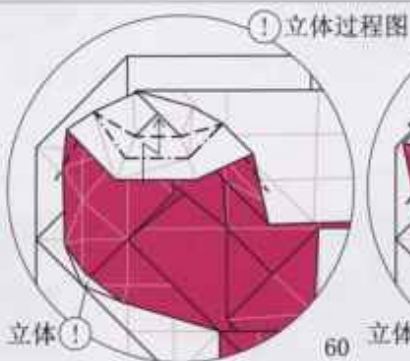
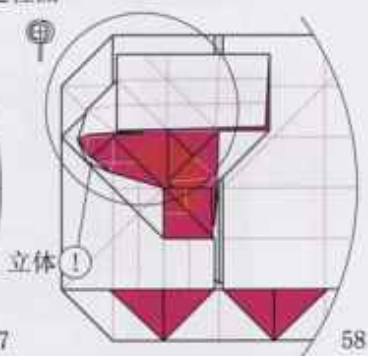
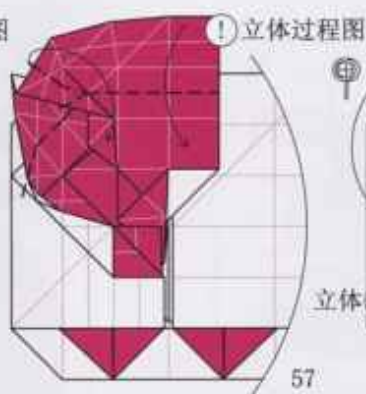



68

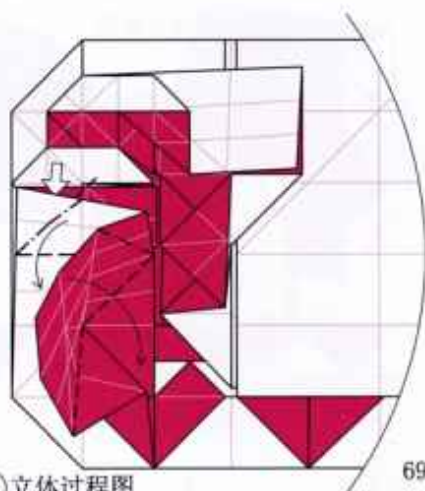

69

! 立体过程图



70

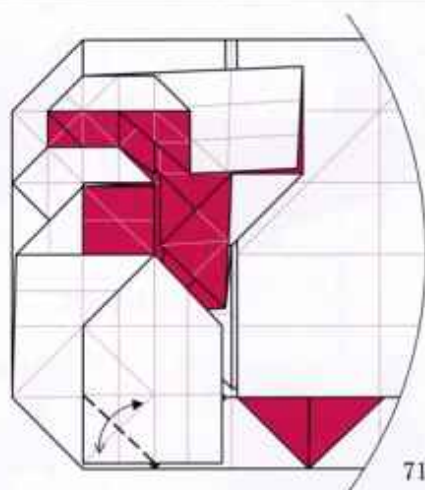

71

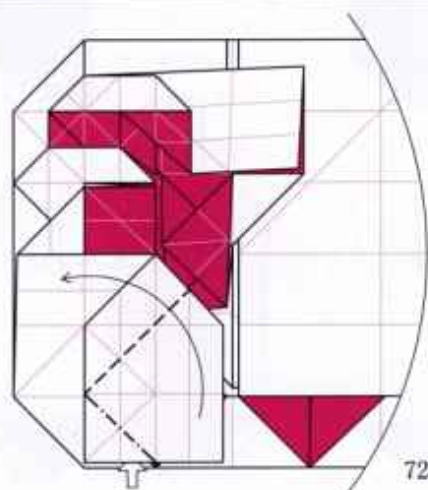

72

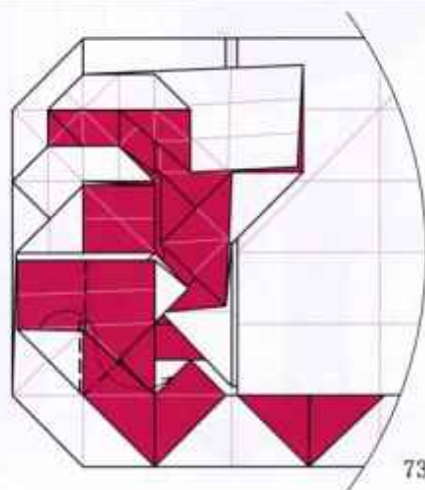

73

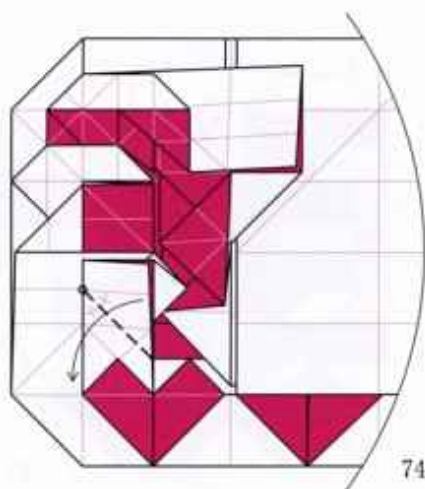

74

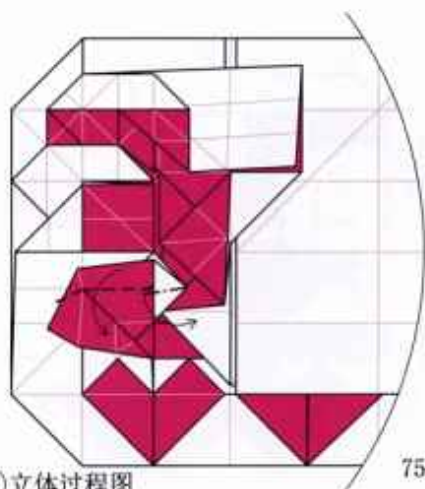

75

① 立体过程图

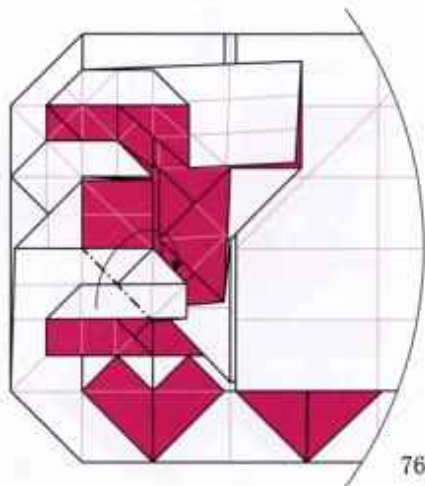

76

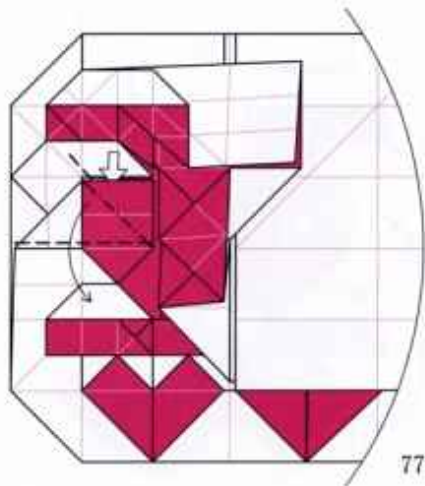

77

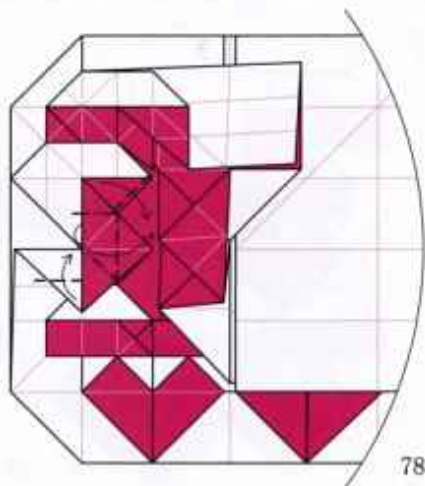

78

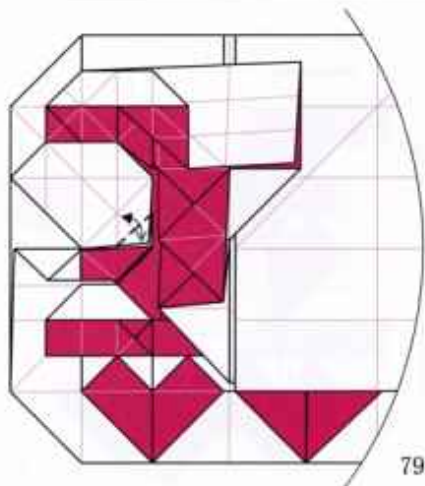

79



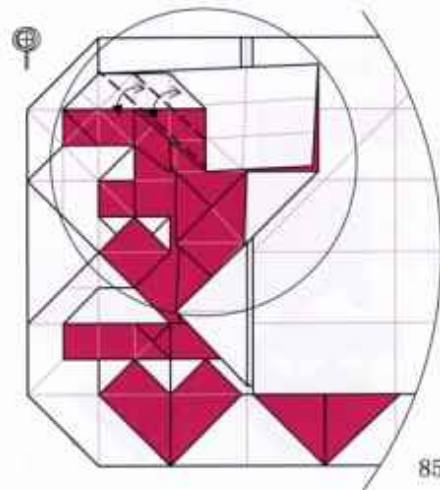
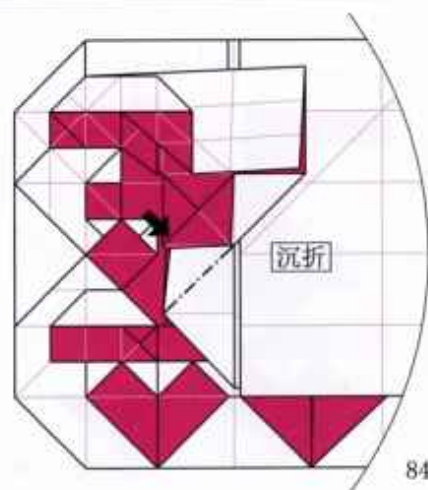
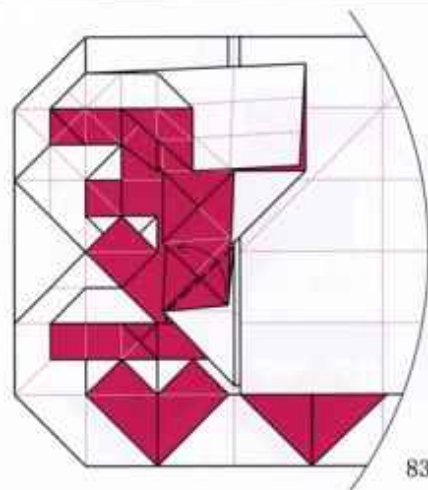
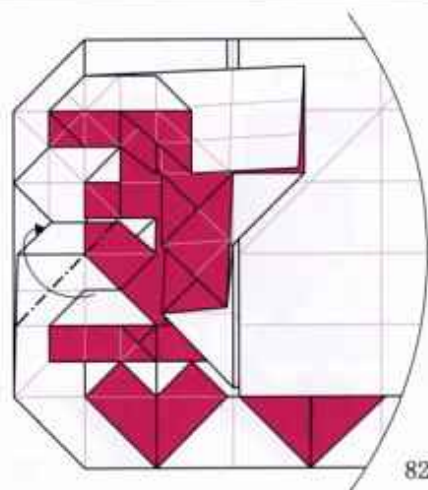
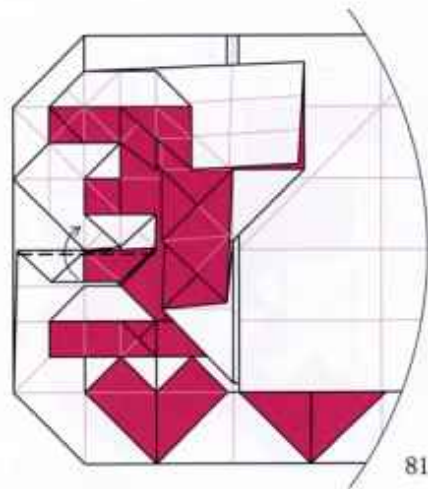
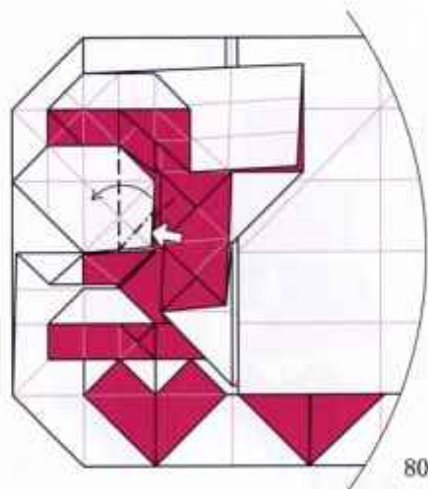



86

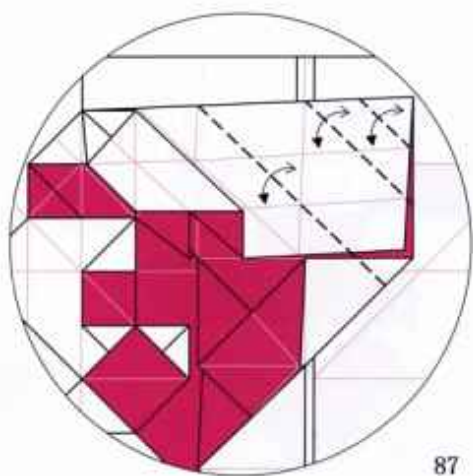

87

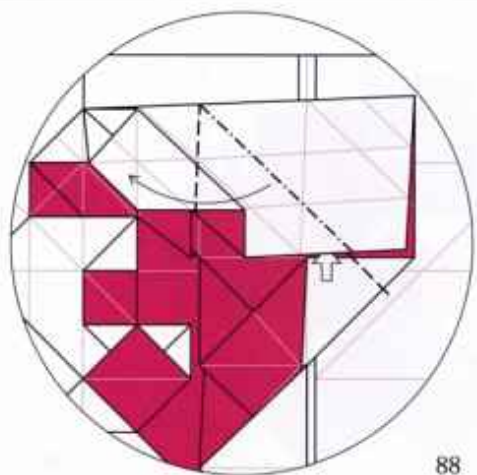

88

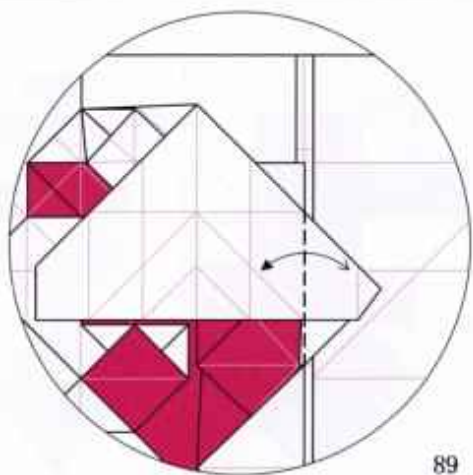

89

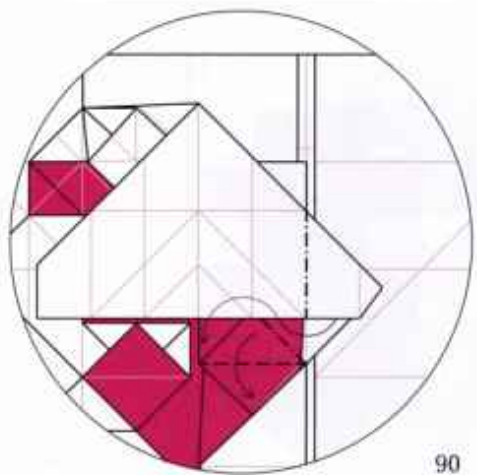

90

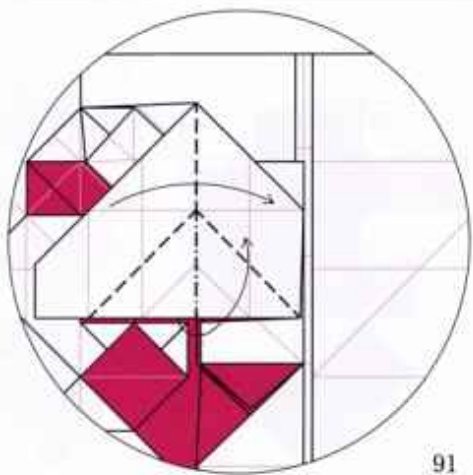

91

① 立体过程图

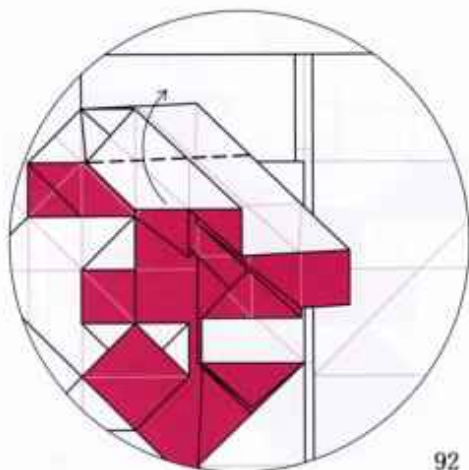

92



93

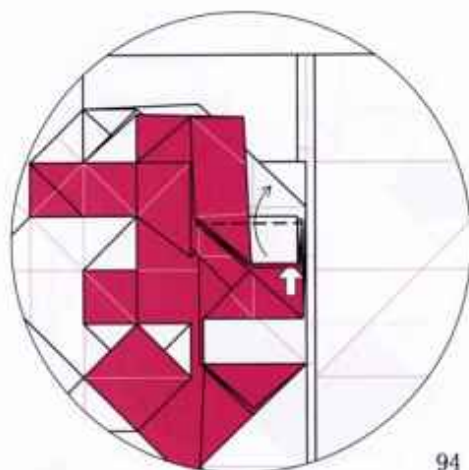

94

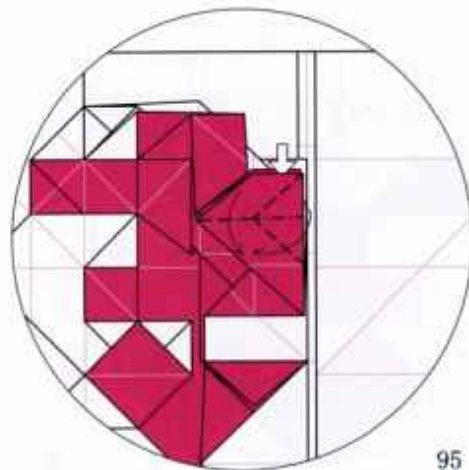

95

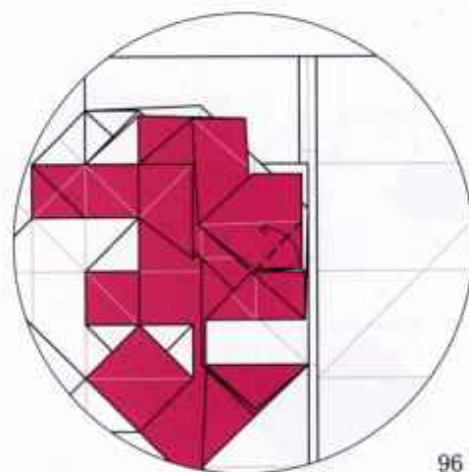

96

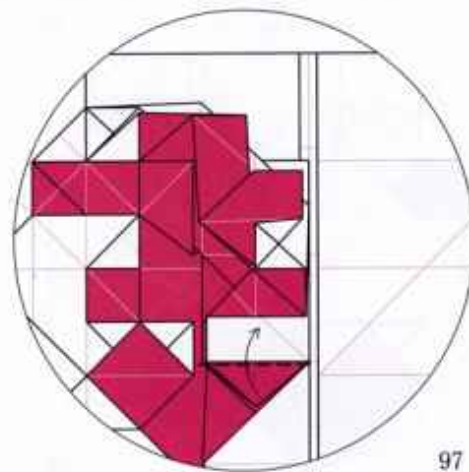

97

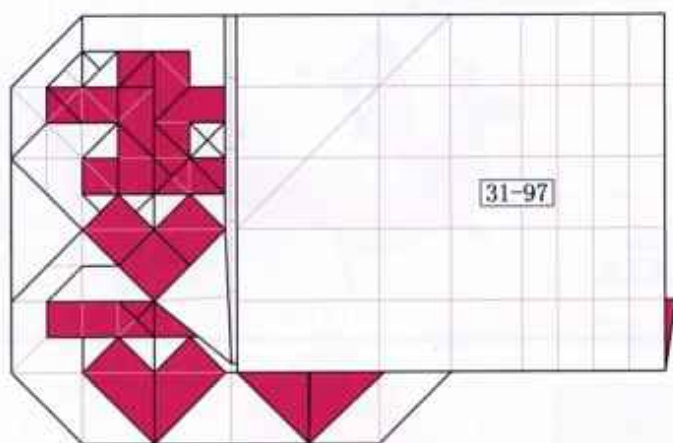

98

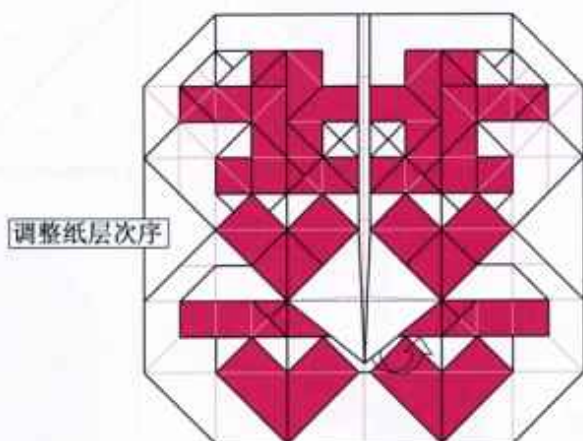

99

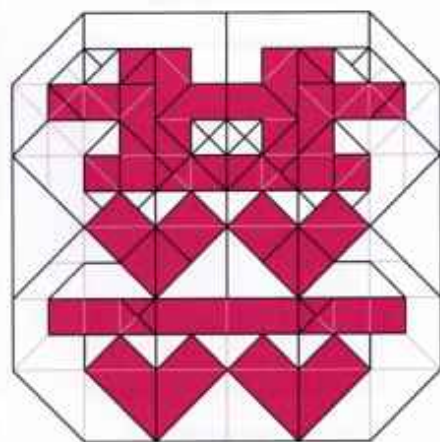

祝百年好合!!

# 飞龙

Pterosaur

设计/Designer  
孟婆

制图/Diagrams  
柒柒

纸张大小/Paper Size  
35 x 35 cm 教育折纸

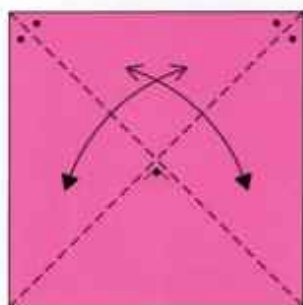
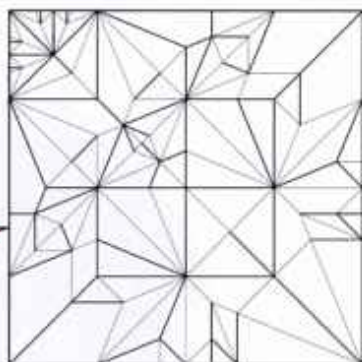
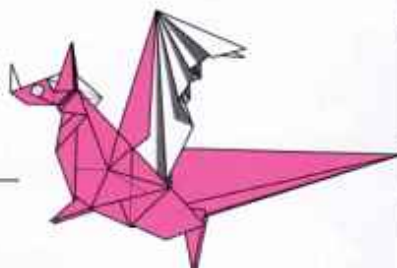

1. Fold along the diagonals and unfold  
沿对角线留下折痕

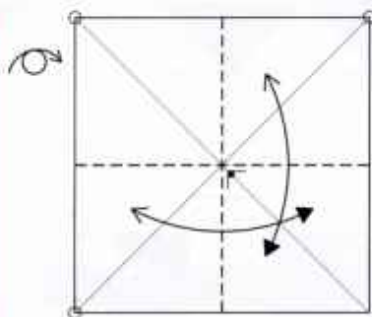

2. Fold then unfold 留下折痕

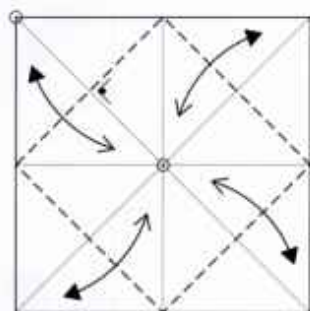

3. Fold then unfold 留下折痕

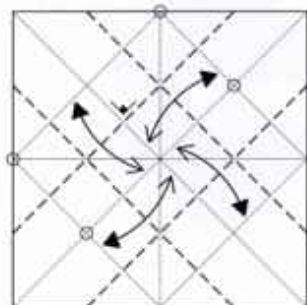

4. Fold then unfold 留下折痕

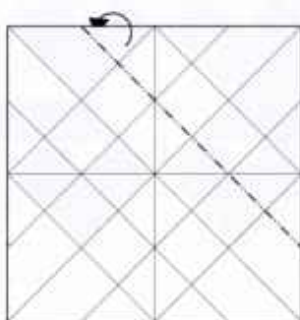

5. Mountain-fold 山折

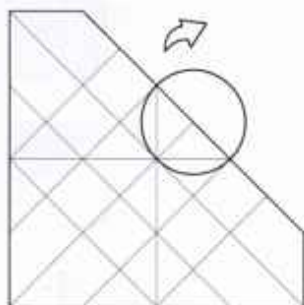

6. Zoom in 放大局部视角

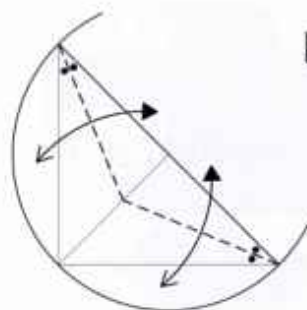

7. Fold then unfold, to step 5.  
留下折痕，展开到步骤5。

To 5

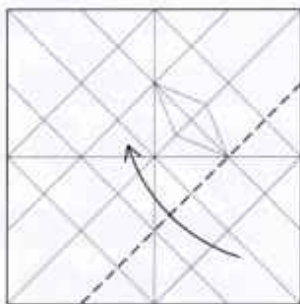

8. Fold then unfold 留下折痕

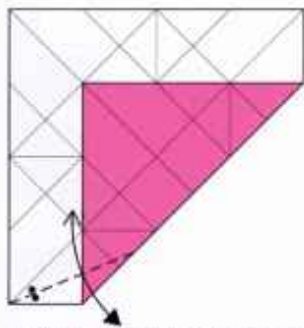

9. Fold then unfold 留下折痕后展开到步骤8

To 8

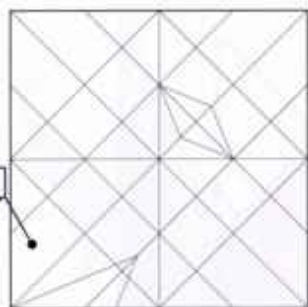

10. Repeat step 8-9 重复步骤8-9

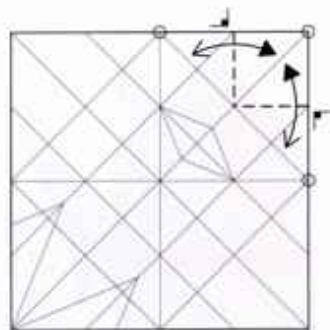

11. Fold then unfold 留下折痕

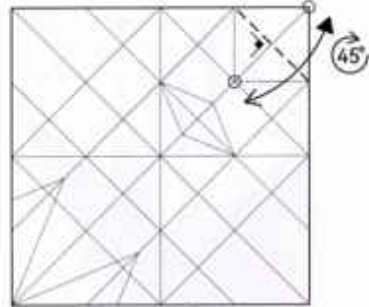

12. Fold then unfold 留下折痕

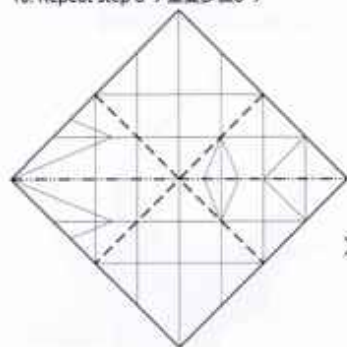

13. Collapse according to the creases 按峰谷聚合

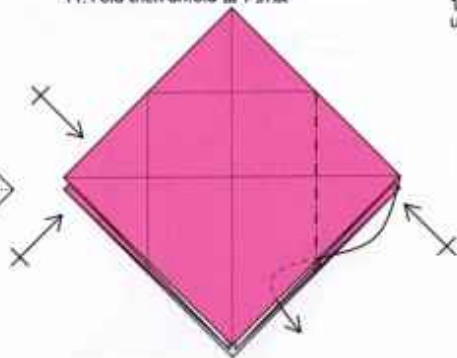

14. Repeat the other three part 其余三个侧重复

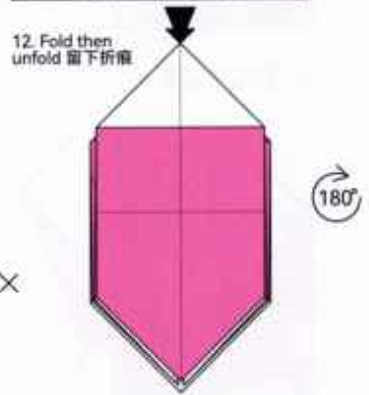

15. Open-sink 开放沉折

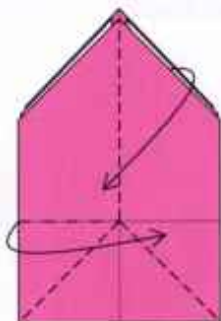

16. Rabbit-ear fold 兔耳折

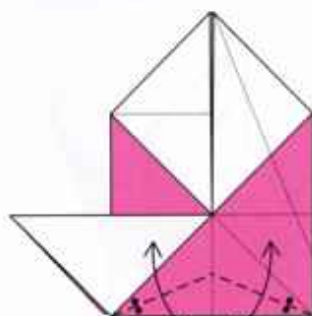

17. Fold then unfold 留下折痕

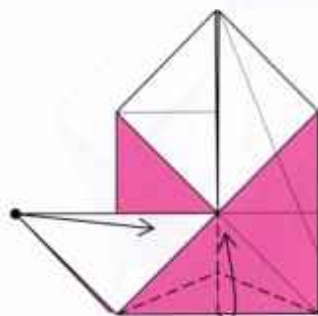

18. Collapse according to the creases. 按峰谷聚合

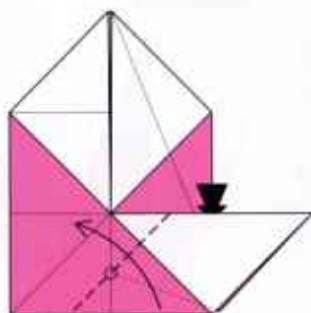

19. Valley-fold 按照谷线折叠会带动后方纸层旋转顺势压平

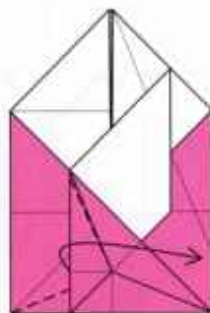

20. Swivel-fold 旋转折叠



21. Repeat step 16-20 对侧重复16到20步

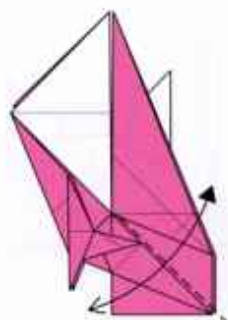

34. Fold then unfold 留下折痕

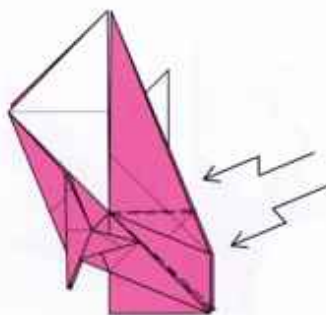

35. Crimp 双向捏折

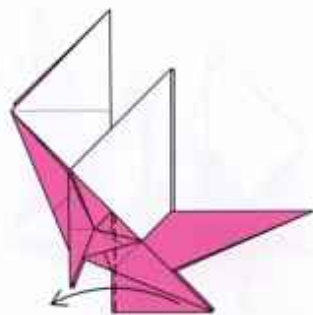

36. Valley-fold 谷折

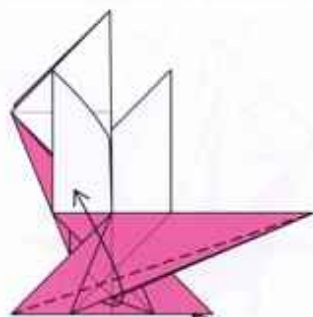

37. Valley-fold repeat behind 谷折 另一侧重复

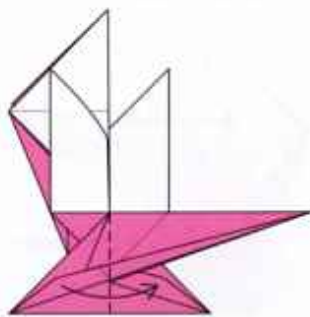

38. Valley-fold 谷折

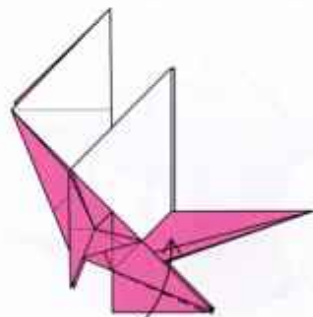

39. Fold then fold 留下折痕

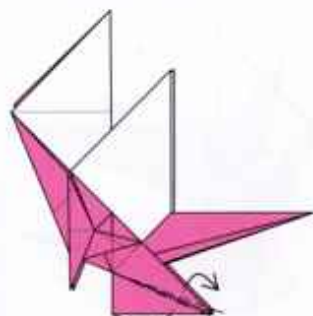

40. Inside reverse-fold 内翻折

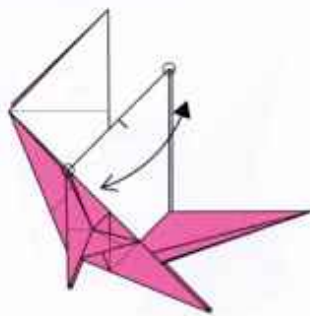

41. Fold then unfold 留下折痕

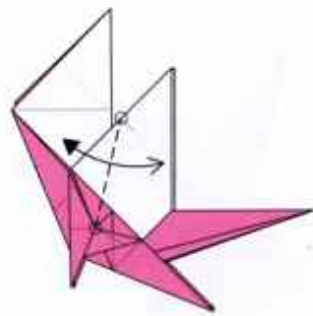

42. Fold then unfold 留下折痕

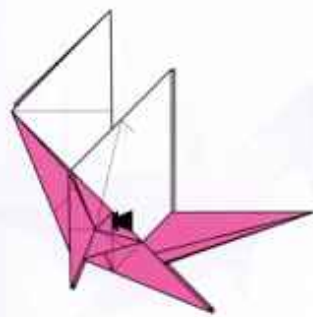

43. Open the layer not flat 打开纸层,此时模型不平

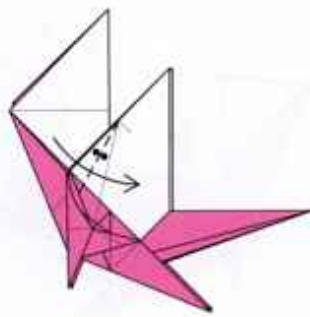

44. Fold then unfold 留下折痕

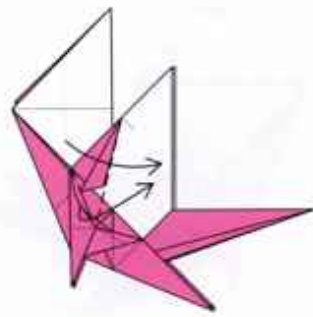

45. Valley-fold, then flatten 谷折, 外侧纸层顺势压平

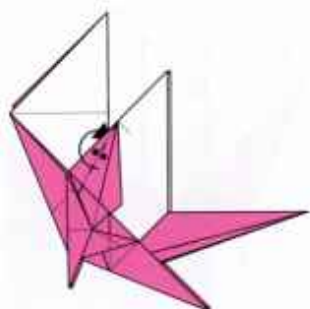

46. Mountain-fold 山折

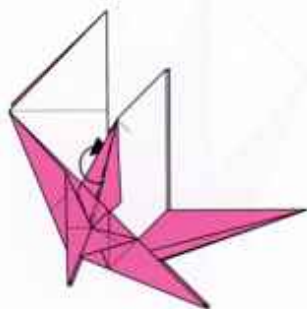

47. Mountain-fold 山折

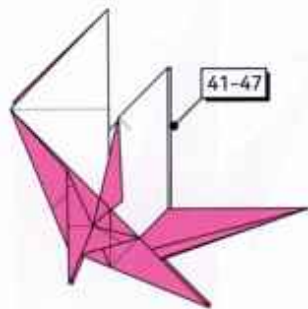

48. Repeat step 41-47 对侧重复41到47步

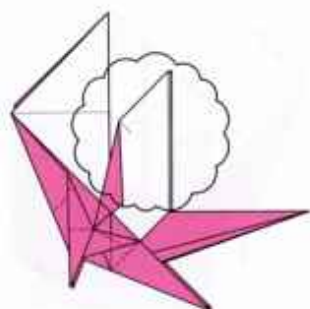

49. 忽略前面的翅膀

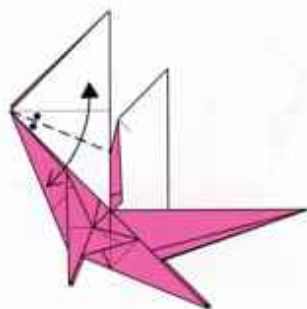

50. Fold then unfold 留下折痕

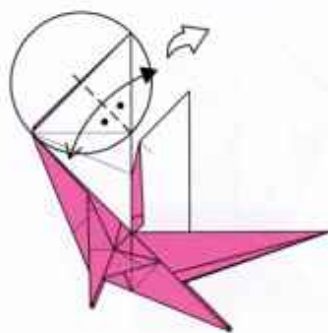

51. Fold then unfold 留下折痕

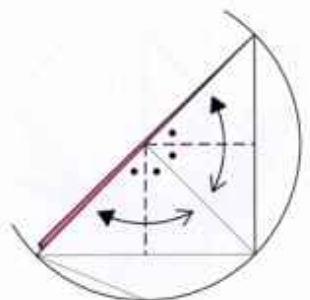

52. Fold then unfold 留下折痕

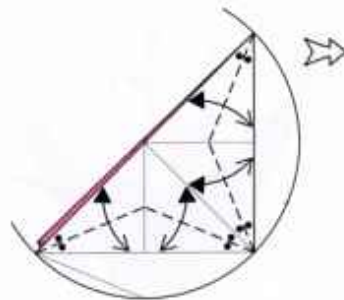

53. Fold then unfold 留下折痕

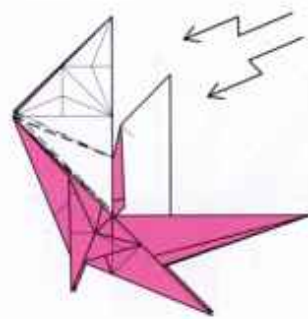

54. Crimp 双向层叠折

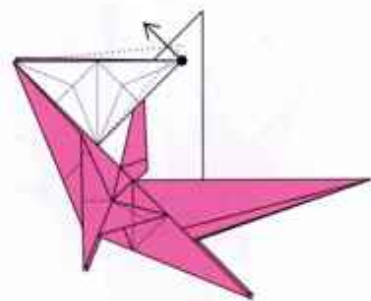

55. pull out a little 向上拉出一点

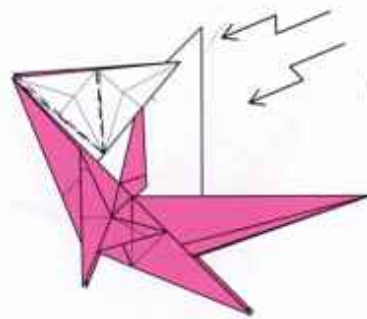

56. Crimp 双向层叠折下一步恢复翅膀

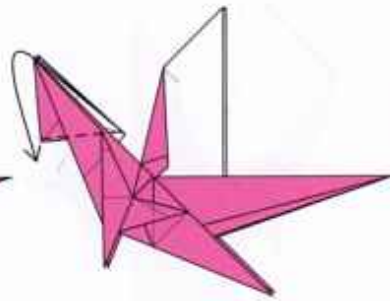

57. Valley-fold 谷折



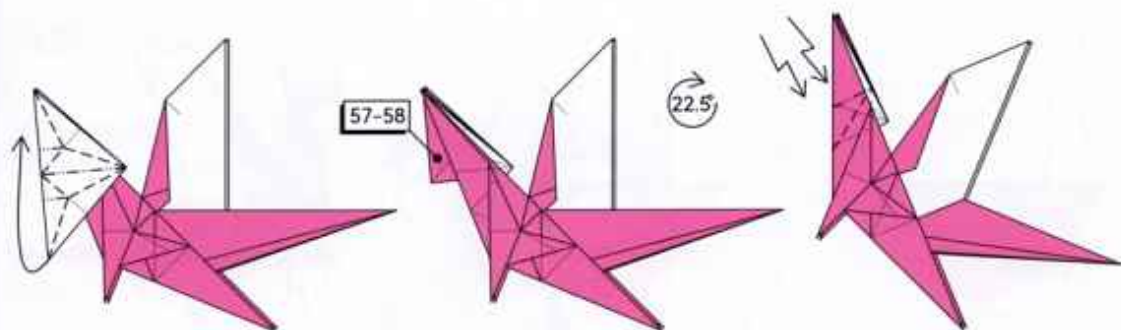

58. Collapse according to the creases.  
按峰谷聚合

59. Repeat step 57-58 重复步骤 57-58

60. Crimp 双向段折

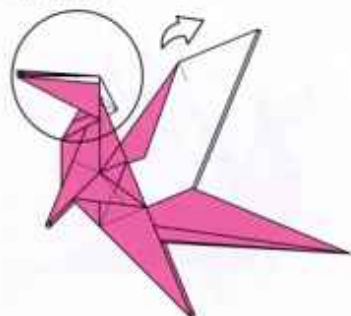

61. Zoom in 放大局部视角

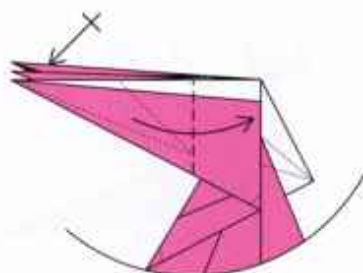

62. Valley-fold, Repeat behind  
谷折 背部重复

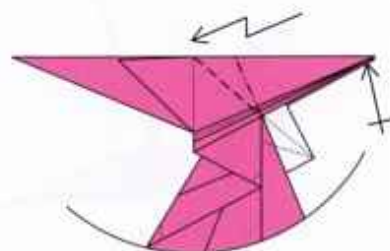

63. Pleat-fold, Repeat behind  
段折 背部重复

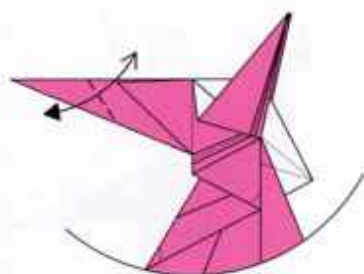

64. Fold then unfold 留下折痕



65. Open-sink 开放沉折



66. Zoom in 放大局部视角

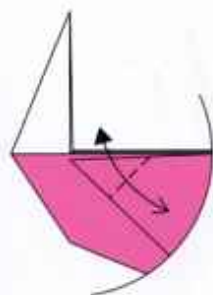

67. Fold then unfold 留下折痕

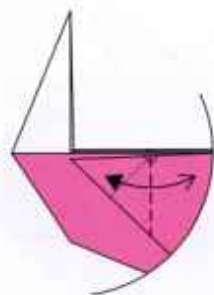

68. Fold then unfold 留下折痕



69. Squash fold 撑开压平

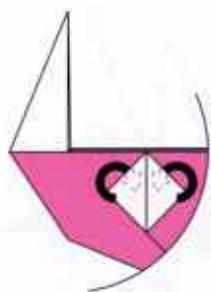

70. Change the color 将纸面翻折到后方

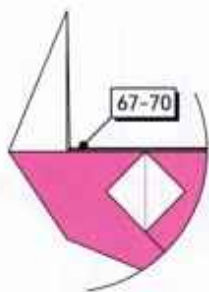

71. Repeat behind 对侧重复67到70步

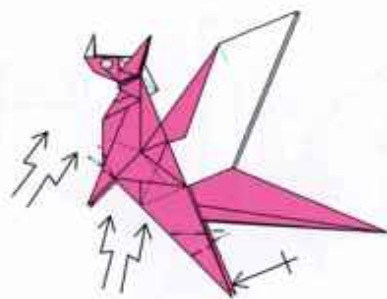

72. Crimp 双向投折

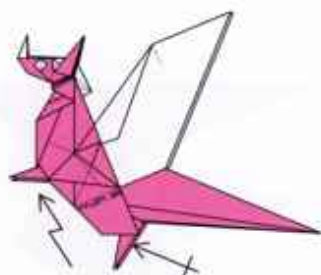

73. Pleat-fold 投折

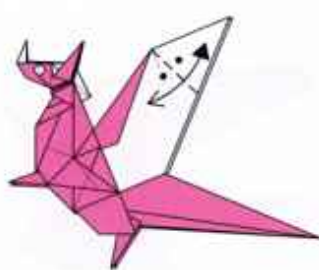

74. Fold then unfold 留下折痕

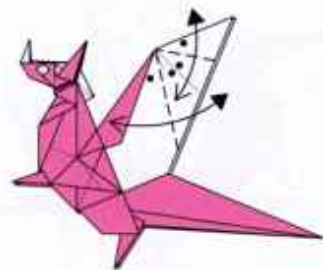

75. Fold then unfold 留下折痕

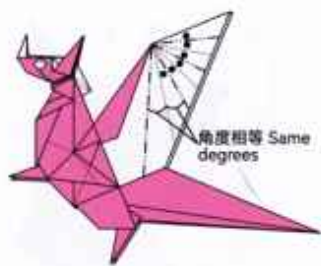

76. Fold then unfold 留下折痕

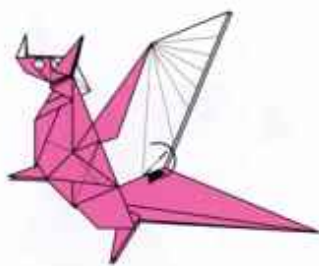

77. Mountain-fold 山折

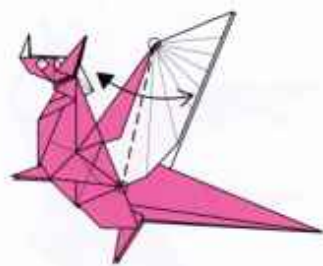

78. Fold then unfold 留下折痕

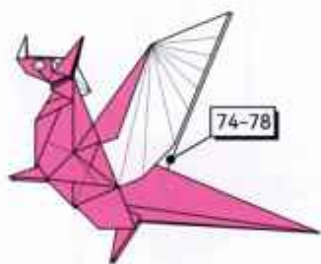

79. Repeat step 75-78 对侧重复74到78步

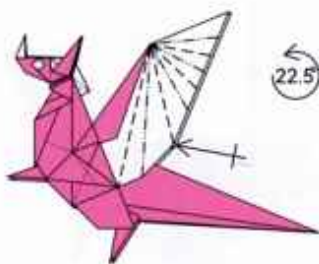

80. Collapse according to the creases. 按峰谷聚合

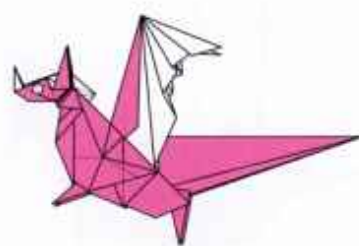

81. Complete 完成

# 浣熊 Raccoon

设计: 孟伟凝  
Design: Meng Weining

推荐用纸/Paper size: 25cm  
9/2021

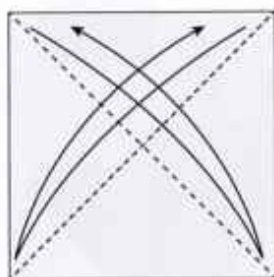
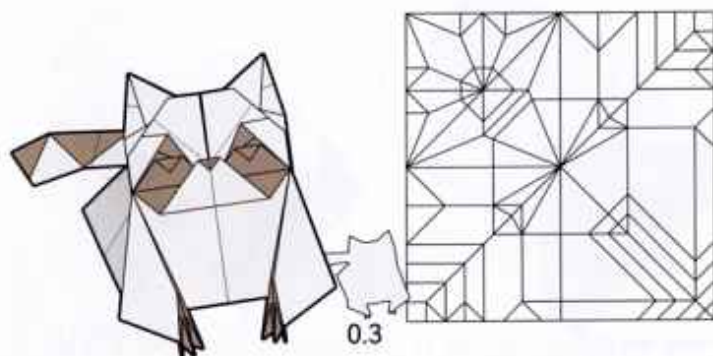

1. Fold along the diagonals and unfold. 沿对角线留下折痕

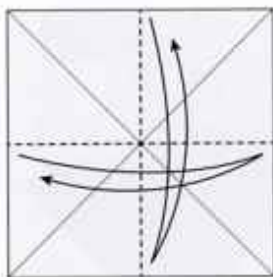

2. Fold then unfold 留下折痕

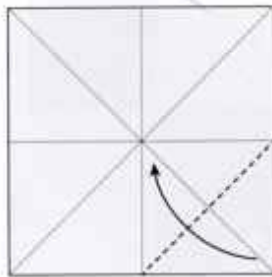

3. Valley-fold 谷折

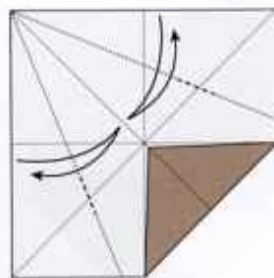

4. Fold then unfold 留下折痕

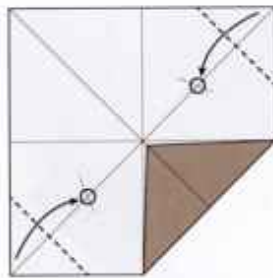

5. Valley-fold 谷折

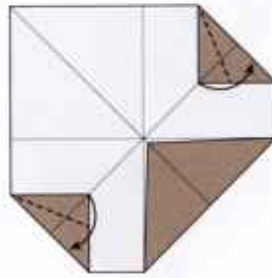

6. Valley-fold 谷折

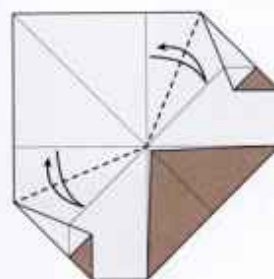

7. Fold then unfold, Turn over 留下折痕后翻转

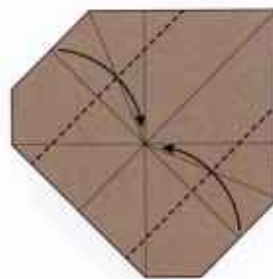

8. Valley-fold 谷折

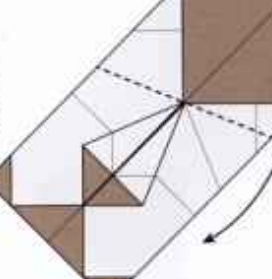

9. Valley-fold 谷折

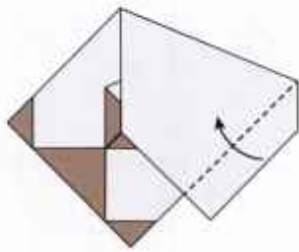

10. Valley-fold 谷折

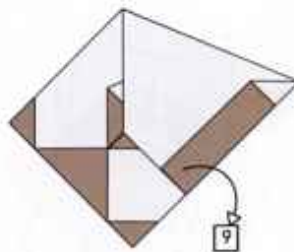

11. Unfold to step 9 展开到第9步骤

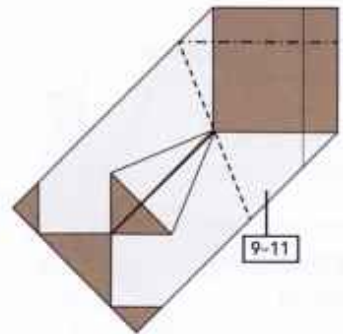

12. Repeat the step 9-11 重复9-11步骤

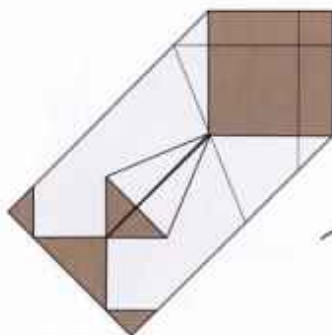

13. Turn over 翻转

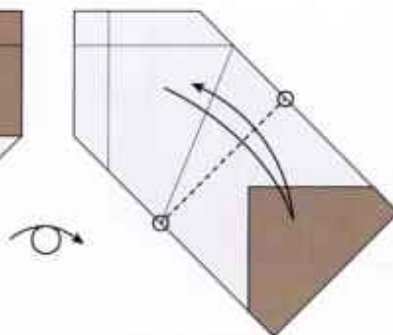

14. Crease according to the marked points. 依参考点留下折痕

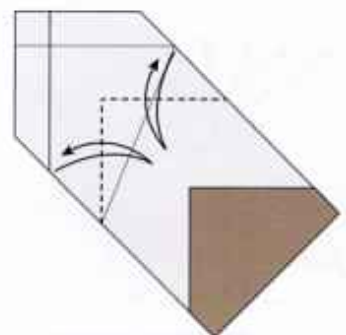

15. Fold then unfold 留下折痕

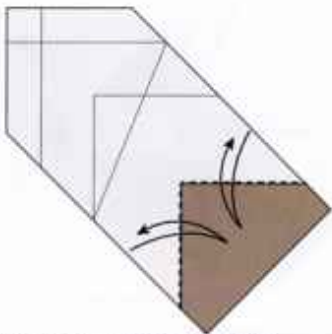

16. Fold then unfold 留下折痕

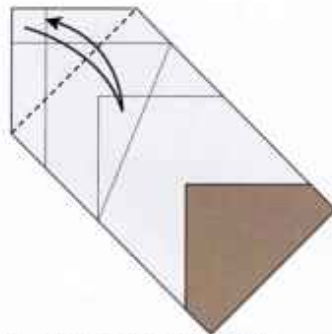

17. Fold then unfold 留下折痕

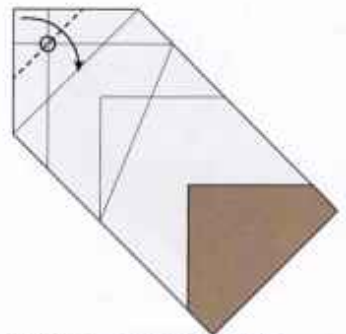

18. Fold then unfold 留下折痕

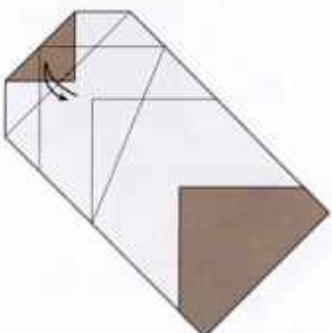

19. Fold then unfold 留下折痕

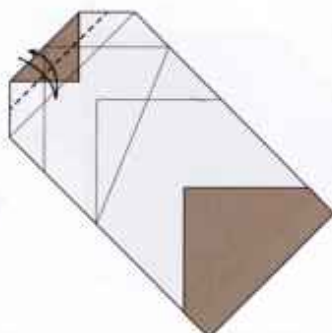

20. Fold then unfold 留下折痕

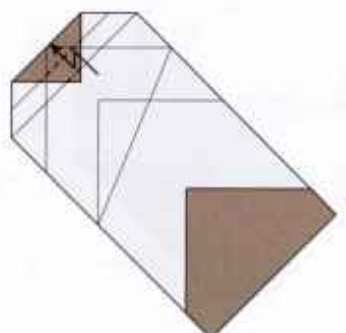

21. Pleat-fold 段折

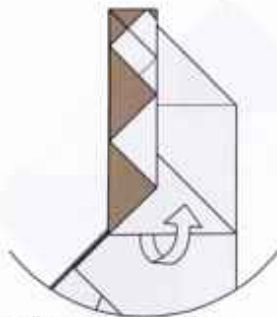

34. Pull out the internal layer  
拉出内部纸层

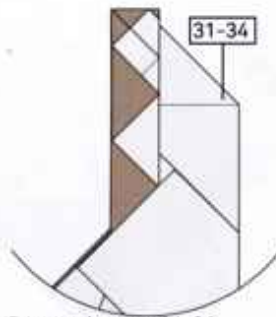

35. Repeat the step 31-34  
重复步骤31-34

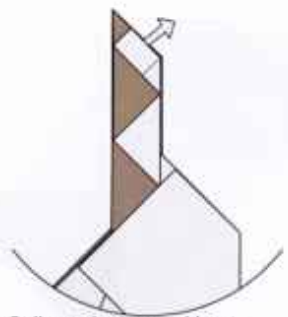

36. Pull out the internal layer  
拉出内部纸层

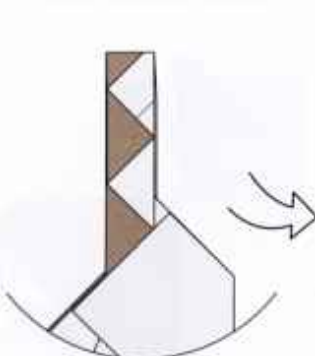

37. Zoom out 缩小局部视角

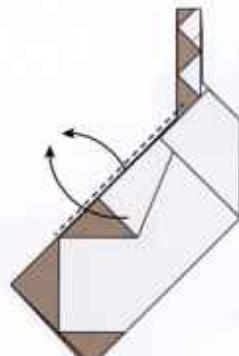

38. Valley-fold 谷折

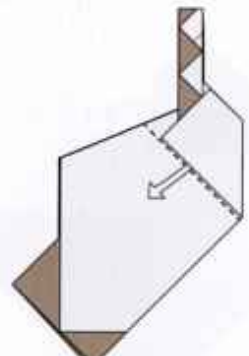

39. Pull out the internal layer  
拉出内部纸层

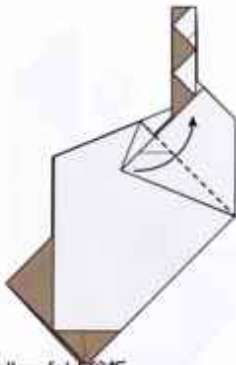

40. Valley-fold 谷折



41. Inside reverse-fold 内翻折

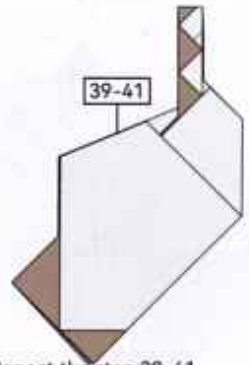

42. Repeat the step 39-41  
重复步骤31-34

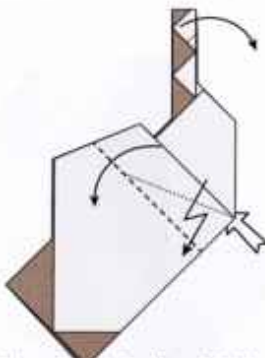

43. Pleat-fold and valley-fold the first layer  
段折同时按照符号旋转折

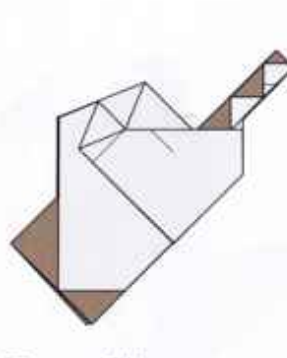

44. Turn over 翻转

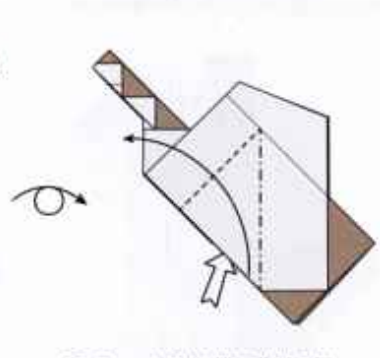

45. Squash-fold 撑开此时不平  
参考下一步骤

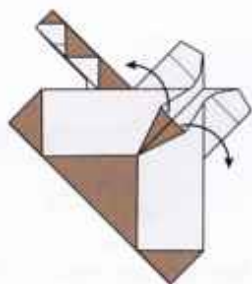

46. Flatten paper layer  
压平纸层

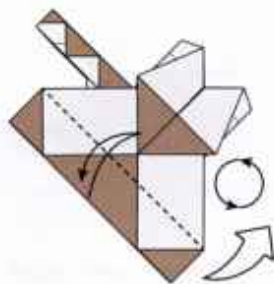

47. Fold then unfold, Rotate 45 degrees  
留下折痕 旋转45度

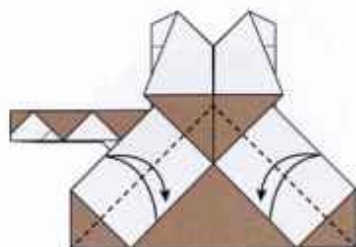

48. Fold then unfold 留下折痕

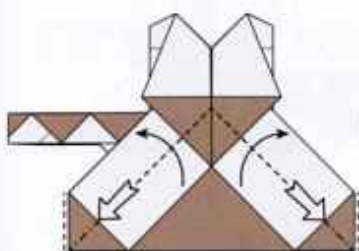

49. Swivel-fold 旋转折叠

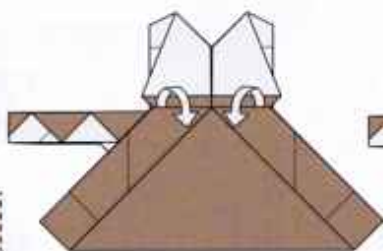

50. Pull out the internal layer  
拉出内部纸层

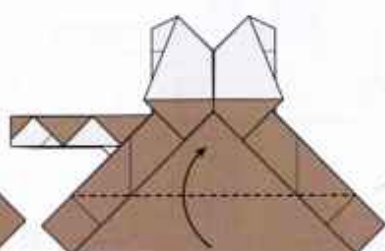

51. Valley-fold 向上山折

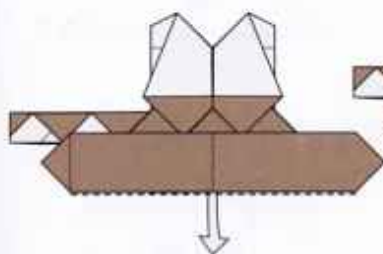

52. Pull out the internal layer  
拉出内部纸层

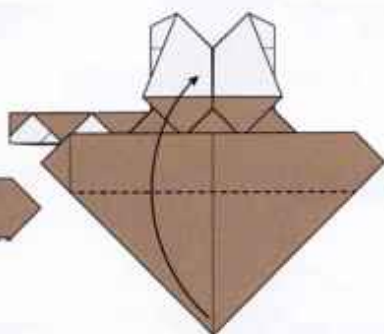

53. Valley-fold 向上山折

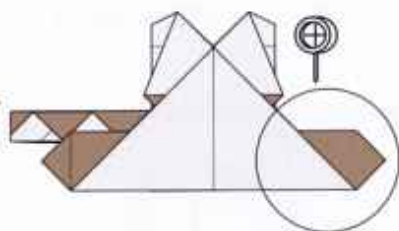

54. Zoom in 放大局部视角

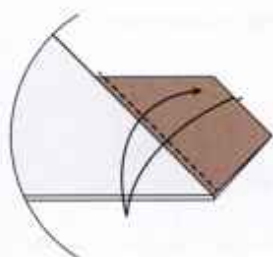

55. Fold then unfold 留下折痕

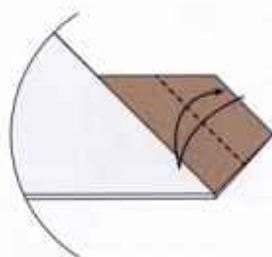

56. Fold then unfold 留下折痕

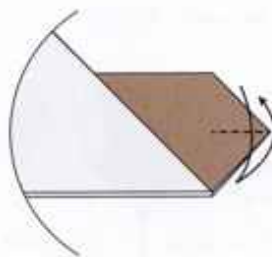

57. Fold then unfold 留下折痕

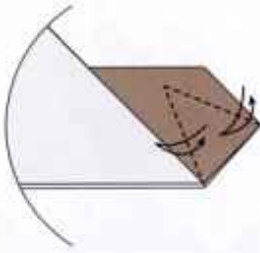

58. Fold then unfold 留下折痕

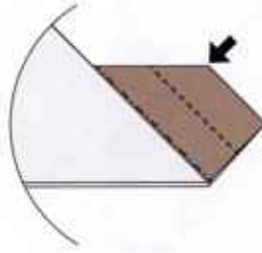

59. Closed sink 闭合沉折

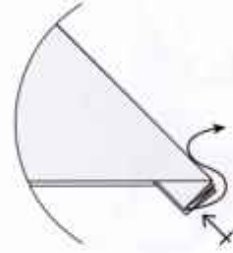

60. Inside reverse- fold, repeat behind 内翻折 后侧重复

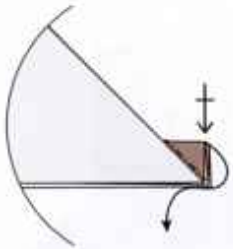

61. Inside reverse- fold, repeat behind 内翻折 后侧重复

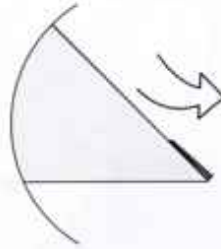

62. Zoom out 缩小局部视角

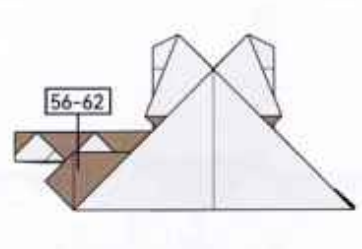

63. Repeat the step 56-62 重复步骤 56-62

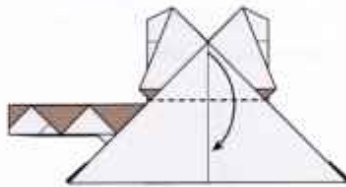

64. Valley-fold the first layer 第一层向下谷折

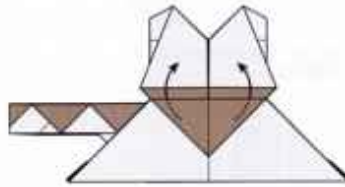

65. Pull out the internal layer 拉出内部纸层

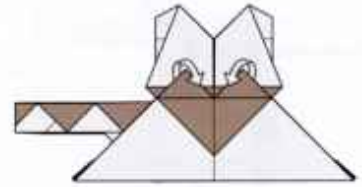

66. Adjusting the paper layer 调整纸层

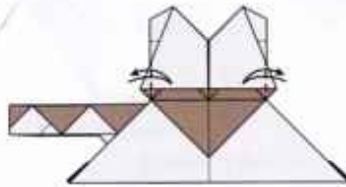

67. Fold then unfold 留下折痕

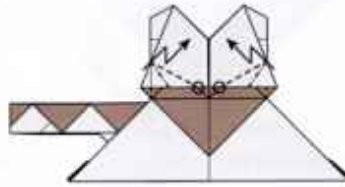

68. Pleat-fold 段折

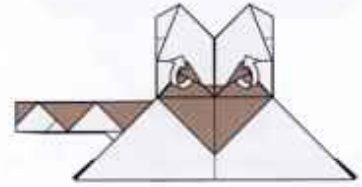

69. Adjusting the paper layer 调整纸层



70. Valley-fold 向上谷折

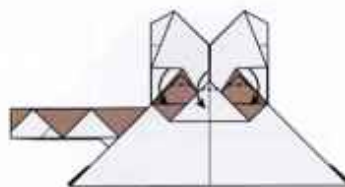

71. Valley-fold 向下谷折

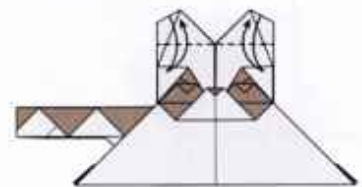

72. Fold then unfold 留下折痕

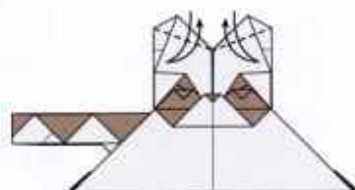

73. Fold then unfold 留下折痕

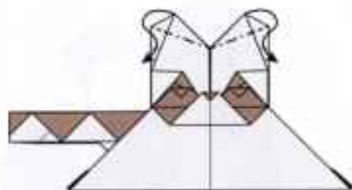

74. Inside reverse-fold 内翻折

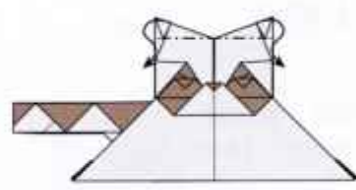

75. Inside reverse-fold 内翻折



76. Fold then unfold 留下折痕

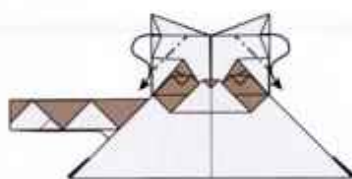

77. Inside reverse-fold 内翻折

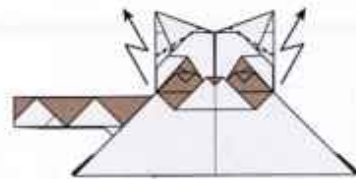

78. Pleat-fold 段折

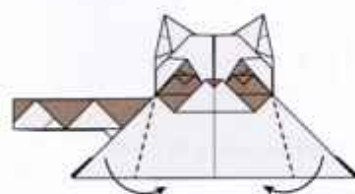

79. Valley-fold 谷折

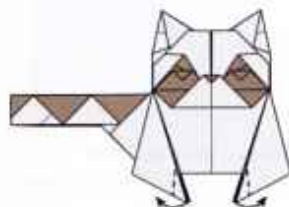

80. Separate the paper layers  
分开纸层 折叠出脚趾

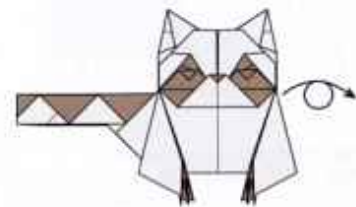

81. Turn over 翻折

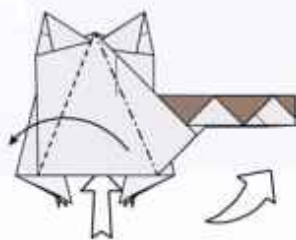

82. 3D version 按照山谷线塑造  
立体效果

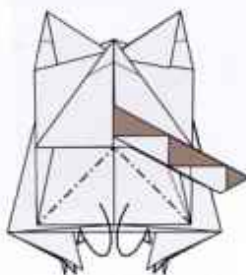

83. Mountain-fold not flat  
山折此时不平3D状态

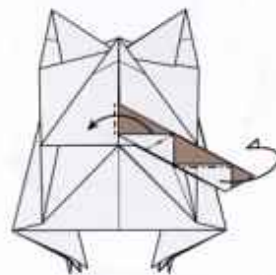

84. Mountain and valley  
山谷折叠调整尾巴姿态

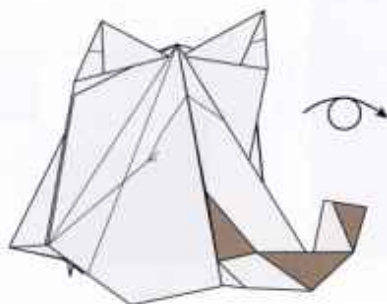

85. Turn over 翻折

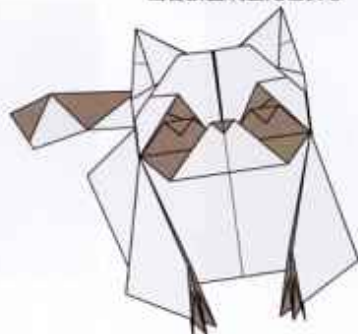

86. Complete 完成



# 大熊猫 Panda

设计: 孟伟凝  
Design: Meng Weining

推荐用纸/Paper size: 25cm  
9/2021

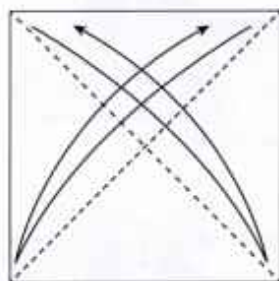
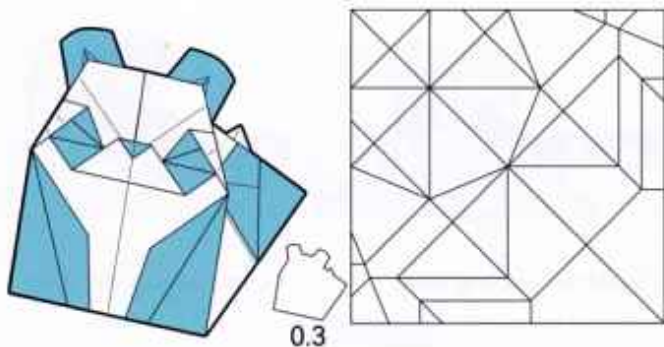

1 Fold along the diagonals and unfold. 沿对角线留下折痕

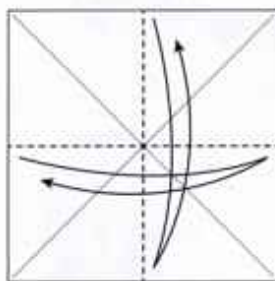

2 Fold then unfold. 留下折痕

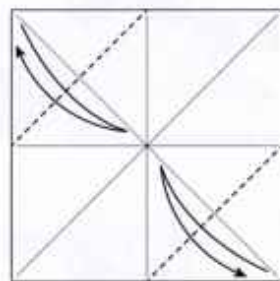

3 Fold then unfold. 留下折痕

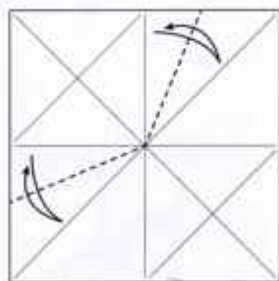

4 Fold then unfold. 留下折痕

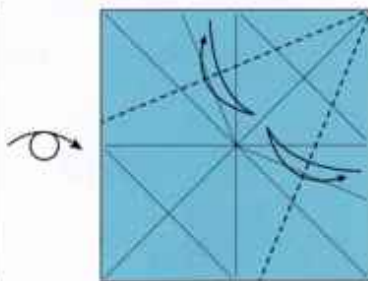

5 Fold then unfold. 留下折痕

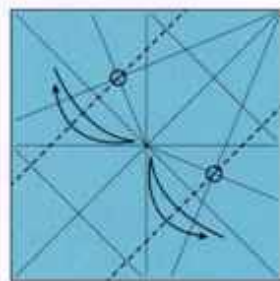

6 Crease according to the marked points. 依参考点留下折痕

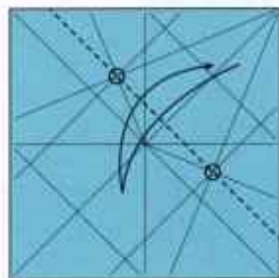

7 Crease according to the marked points. 依参考点留下折痕

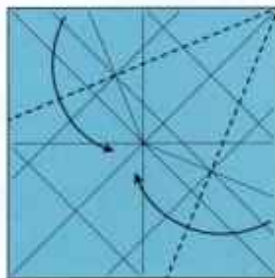

8 Fold then unfold. 留下折痕

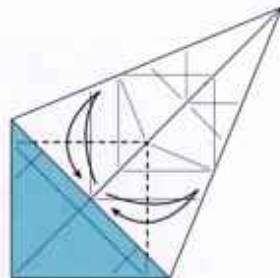

9 Fold then unfold. 留下折痕

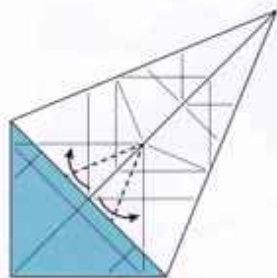

10 Fold then unfold. 留下折痕

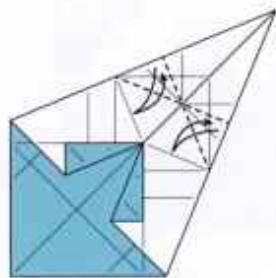

11 Fold then unfold. 留下折痕

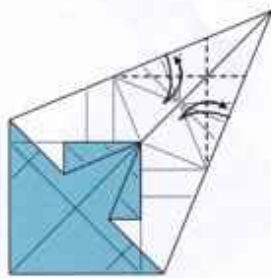

12 Fold then unfold. 留下折痕

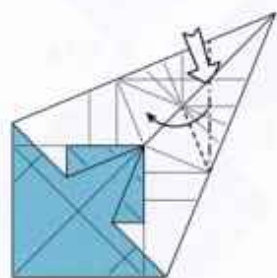

13 Swivel-fold. 旋转折

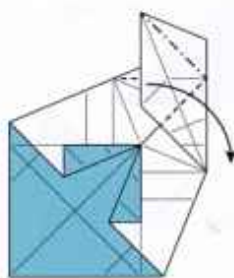

14 Swivel-fold. 旋转折

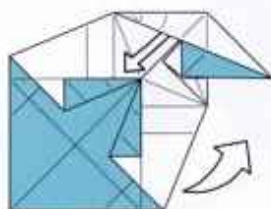

15 Pull out the inner layer  
拉出内部纸层

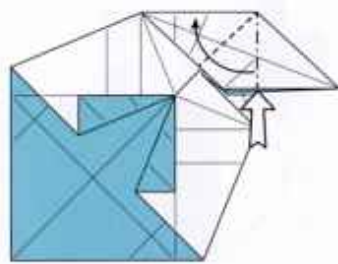

16 Squash fold 撑开压平



17 Valley-fold 谷折

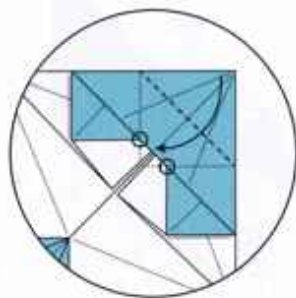

18 Valley-fold 谷折

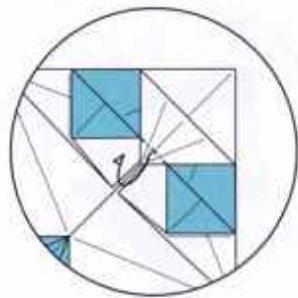

19 Mountain-fold 山折

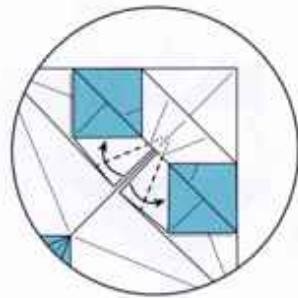

20 Valley-fold 谷折

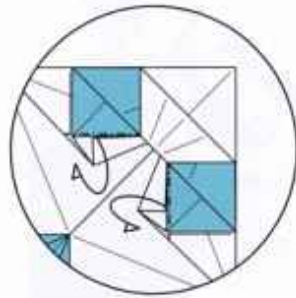

21 Mountain-fold 山折

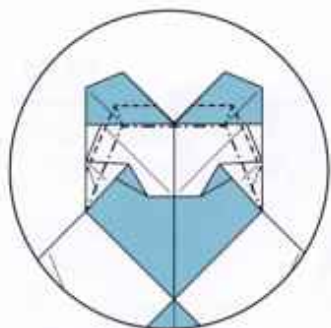

34 Collapse according to the creases. 按峰谷聚合

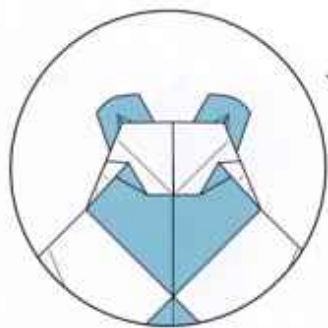

35 Zoom out 缩小局部视角

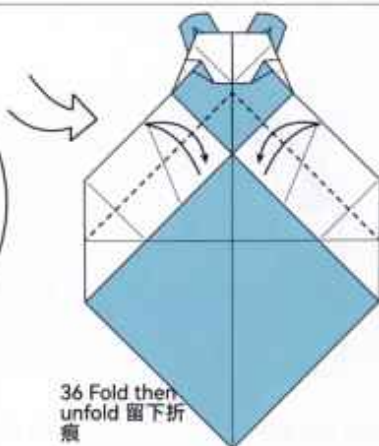

36 Fold then unfold 留下折痕

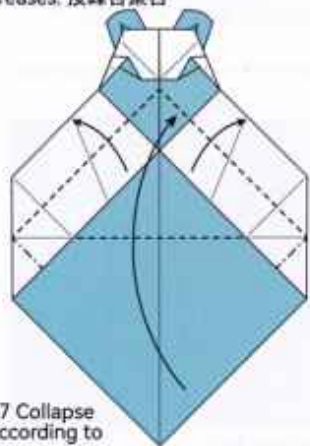

37 Collapse according to the creases. 按峰谷聚合

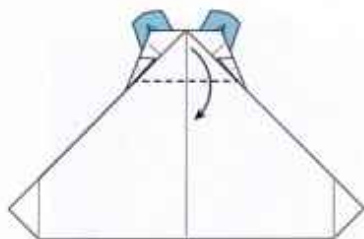

38 Valley-fold 谷折

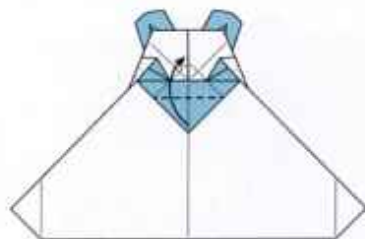

39 Valley-fold 谷折

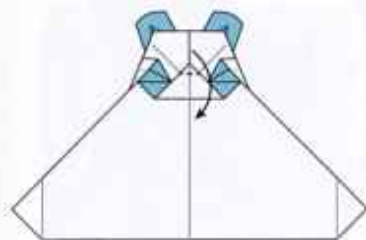

40 Valley-fold 谷折

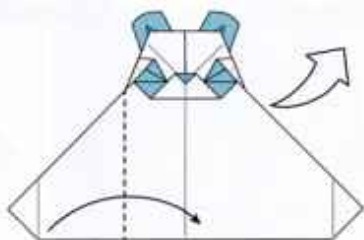

41 Valley-fold 谷折

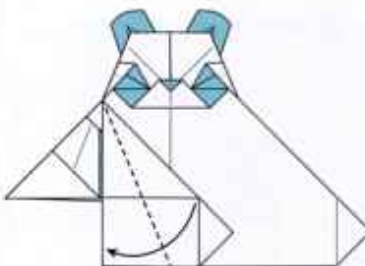

42 Valley-fold 谷折

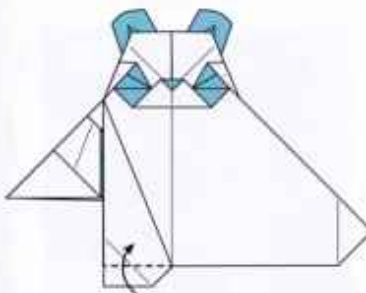

43 Valley-fold 谷折

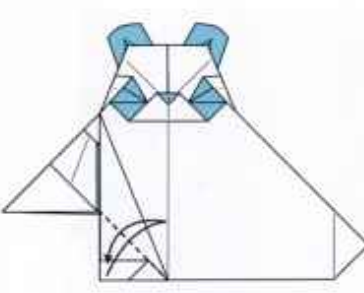

44 Fold then unfold 留下折痕

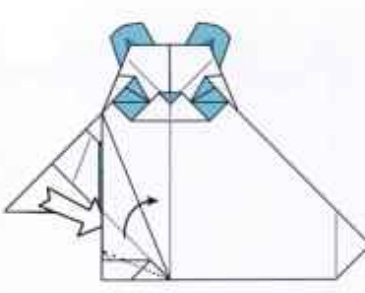

45 Swivel-fold. 旋转折

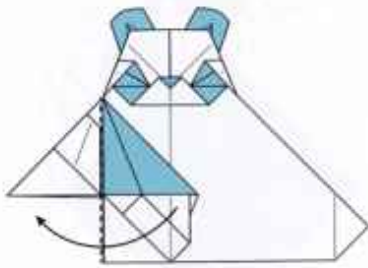

46 Valley-fold 谷折

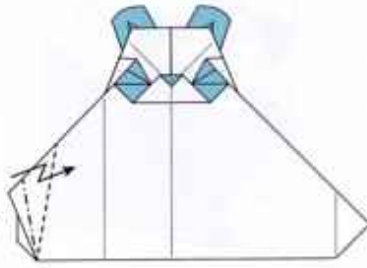

47 Pleat fold 段折

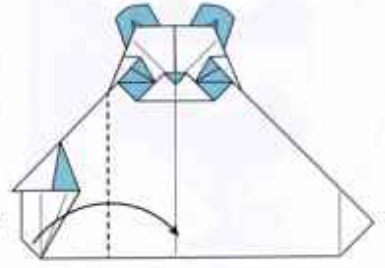

48 Valley-fold 谷折

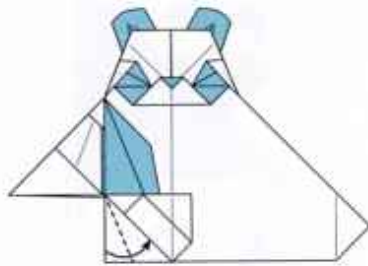

49 Valley-fold 谷折

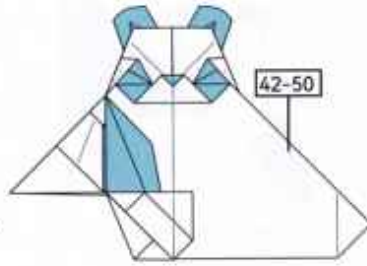

50 Repeat step 42-50 重复步骤42-50



51 Turn over 翻转

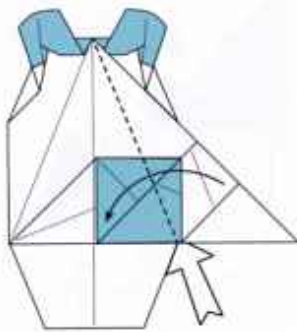

52 Squash fold 撑开压平

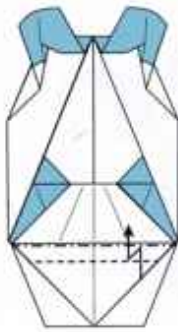

53 Pleat-fold 段折

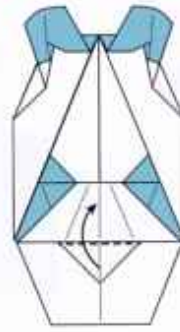

54 Valley-fold 谷折

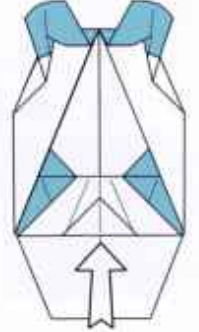

55 Open 3D version 撑开 3D过程

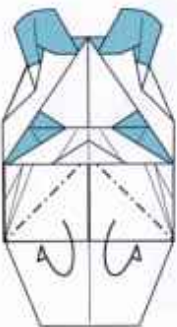

56 Mountain-fold 山折

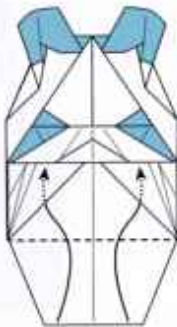

57 Vally-fold in pocket

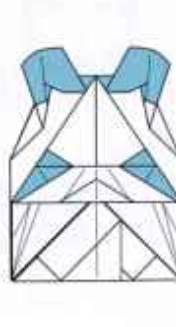

58 Turn over 翻转

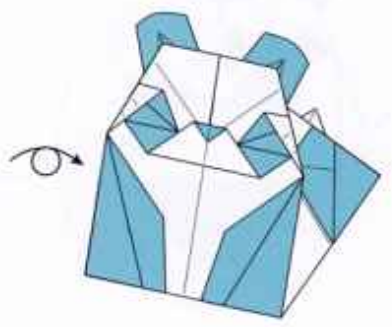

59 Complete 完成

# 鸣蛇

Singjing snake

设计/Designer  
张义帆 Zhang Yifan

制图/Diagrams  
柒柒

纸张大小/Paper Size  
35 x 35 cm biotope

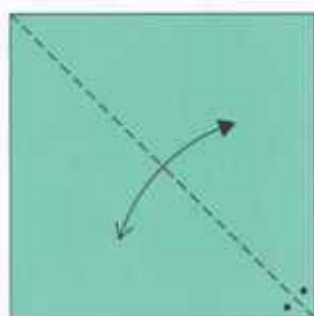
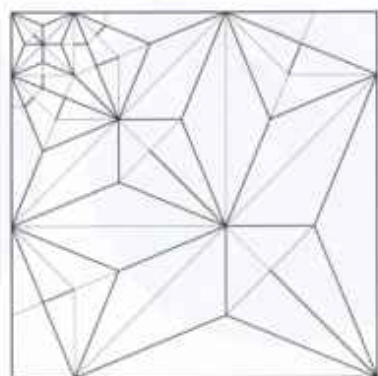

1.

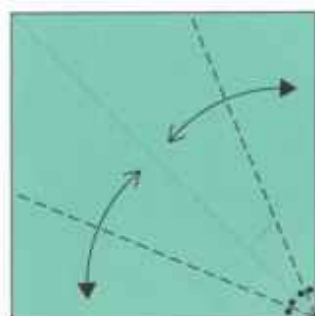

2.

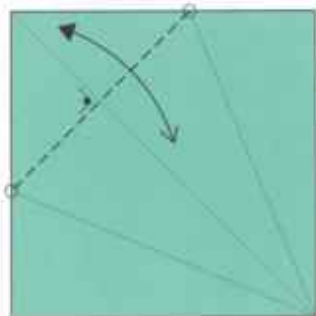

3.

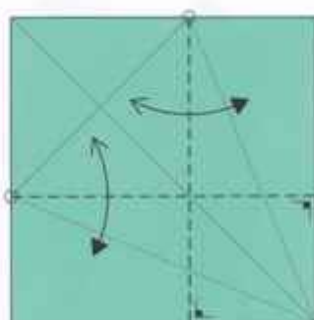

4.

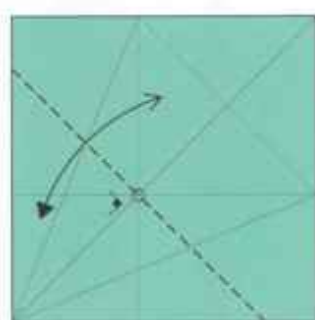

5.

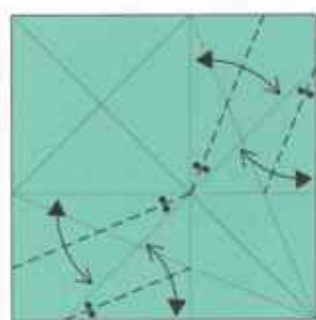

6.

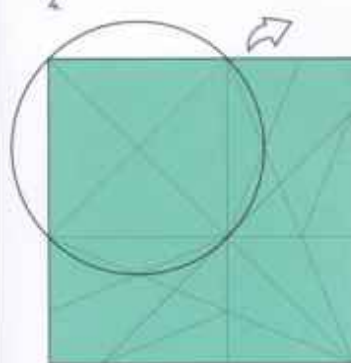

7.

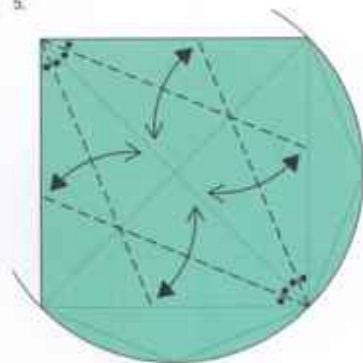

8.

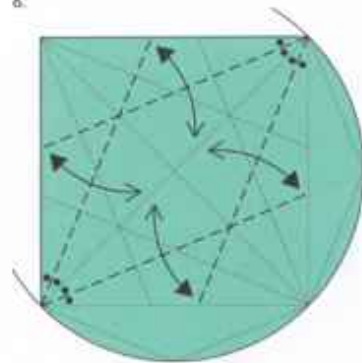

9.

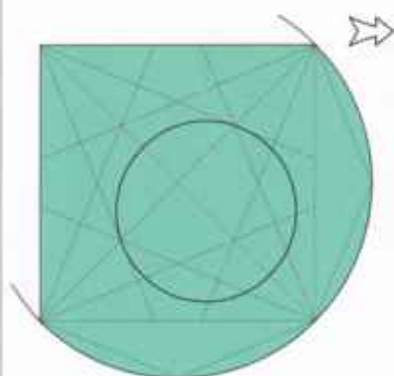

10.

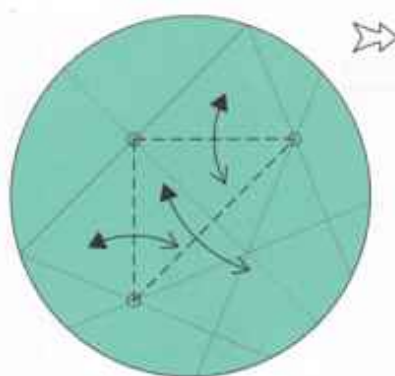

11.

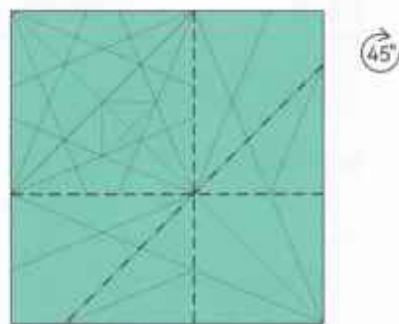

12 按縫谷聚合

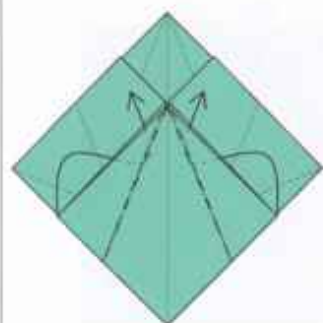

13.

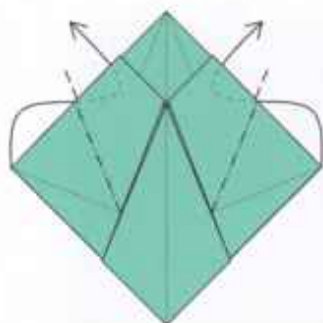

14.

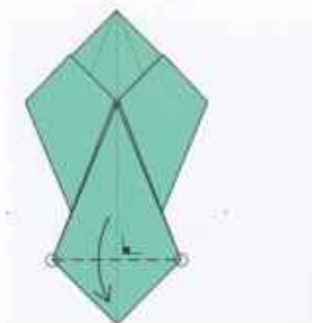

15.

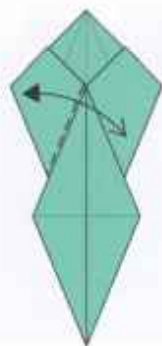

16.

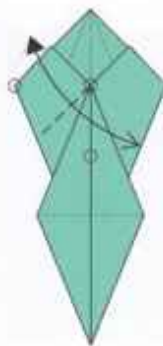

17.

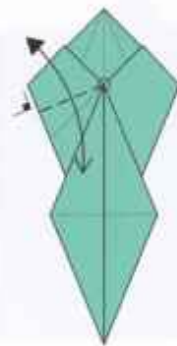

18.

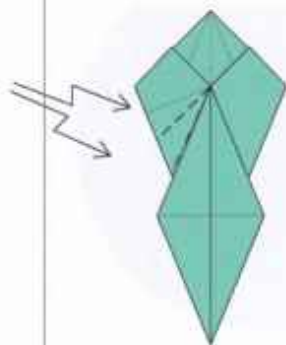

19.

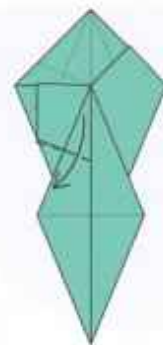

20.

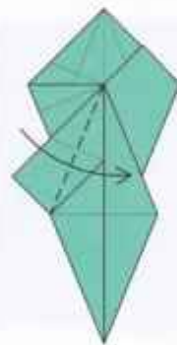

21.

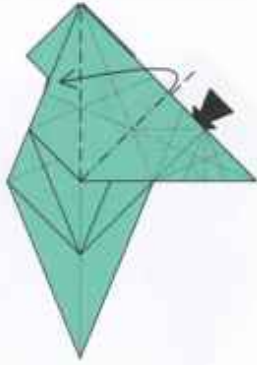

34.

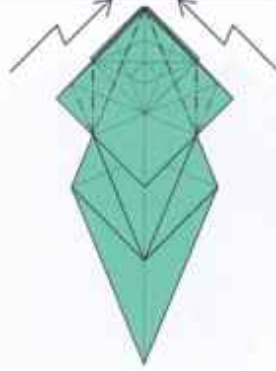

35.



36.



37.

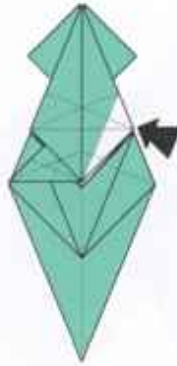

38. 开放沉折

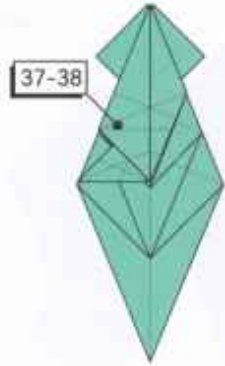

39.



40.



41.



42.

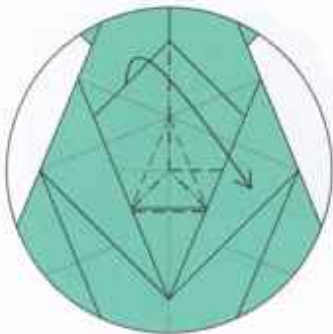

43.

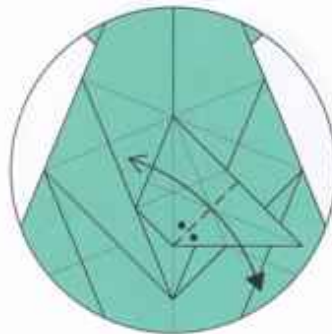

44.

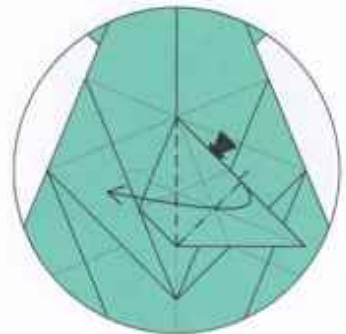

45.

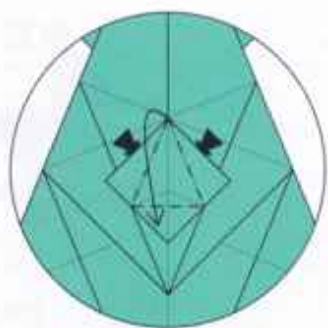

46.



47.



48.

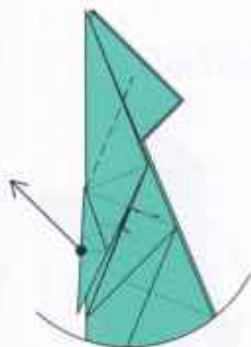

49.

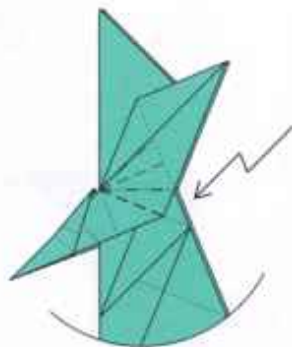

50.

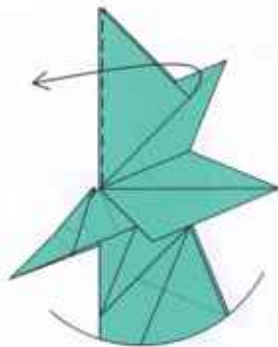

51.

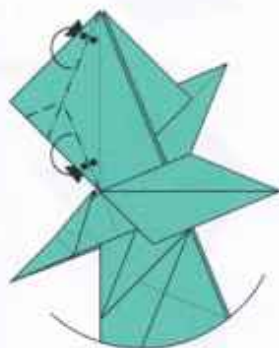

52. Rabbit-ear fold 兔耳折

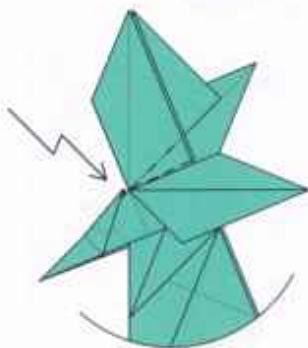

53. Pleat-fold 段折

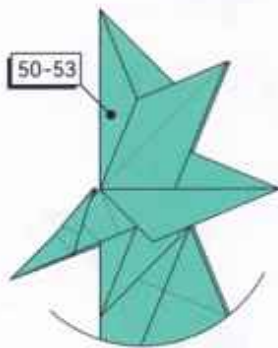

54. Repeat step 50-53  
重复步骤 50-53

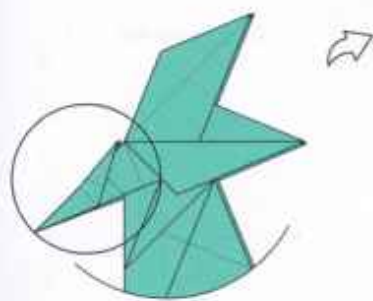

55. Zoom in 放大局部视角

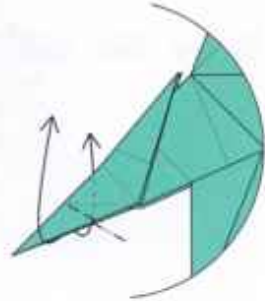

56. Outside reverse-fold 外翻折

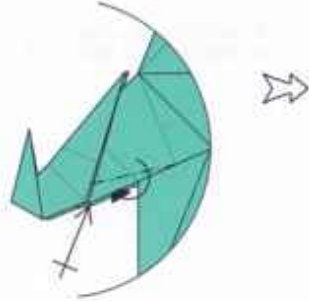

57. Mountain-fold 山折 背面重复



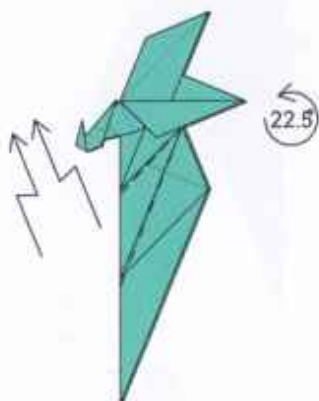

58. Crimp 双向段折

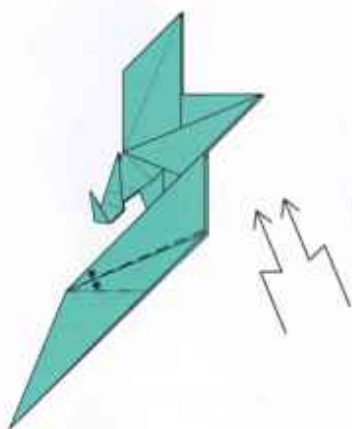

59. Crimp 双向段折

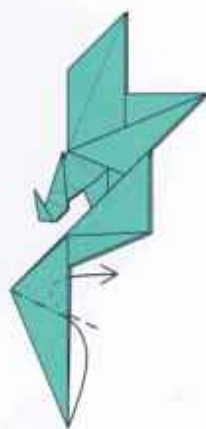

60. Inside reverse-fold  
内翻折 背面重复

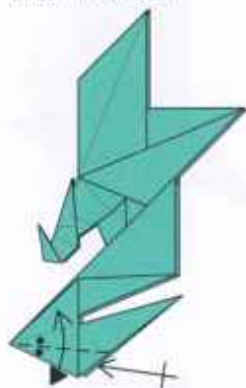

61. Fold then unfold  
留下折痕 背面重复

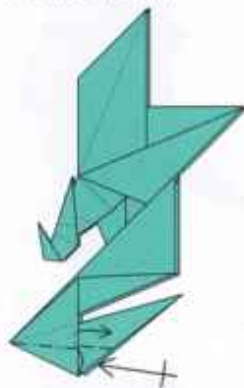

62. Inside reverse-fold  
内翻折 背面重复

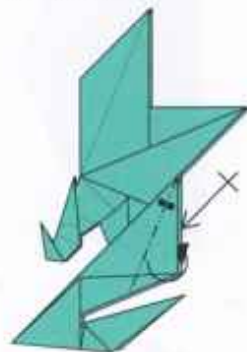

63. Mountain-fold 山折 背面重复

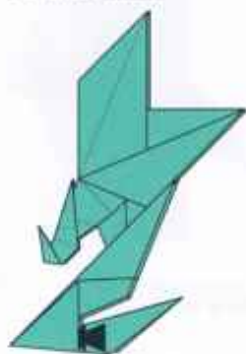

64. Flatten layers, reference to the  
next step 撑开压平 参考下一步。

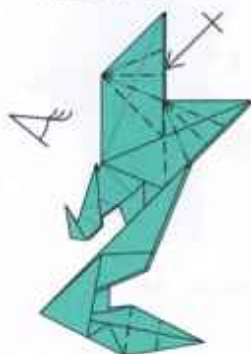

65. Refer to creaseline 3D version  
立体化操作, 调整尾巴和翅膀



66. Complete 完成 ~

# 耳鼠

Ear mouse

设计/Designer  
张义帆

制图/Diagrams  
柒柒

纸张大小/Paper Size  
35 x 35 cm 教育折纸

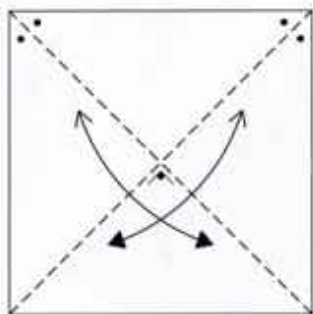
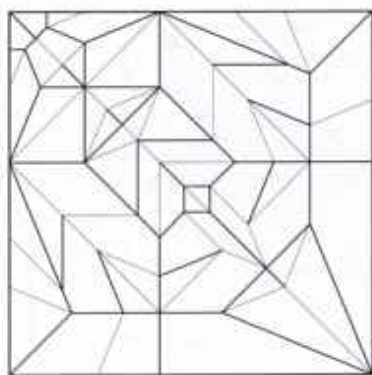
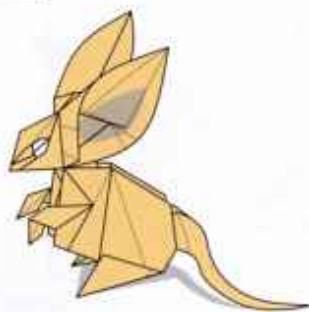

1.

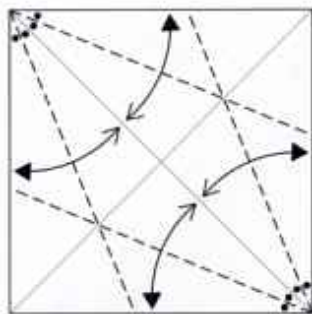

2.

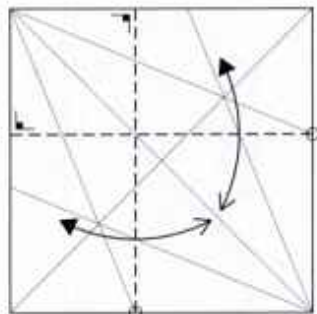

3.

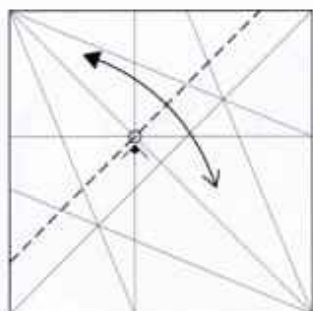

4.

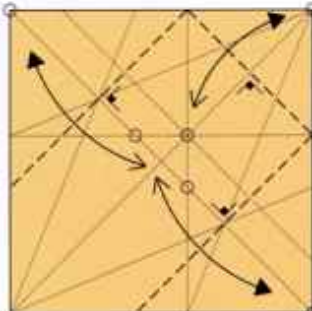

5.

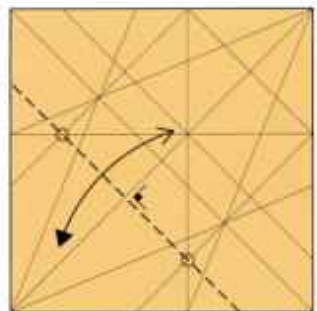

6.

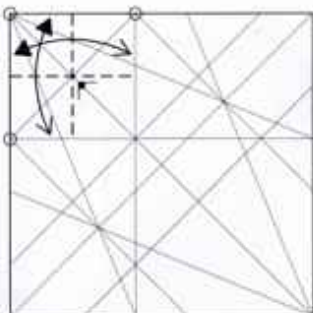

7.

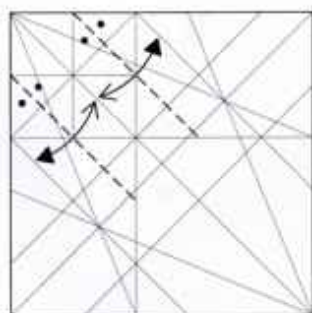

8.

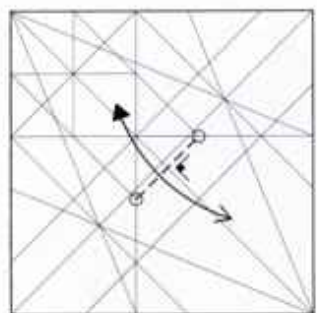

9.

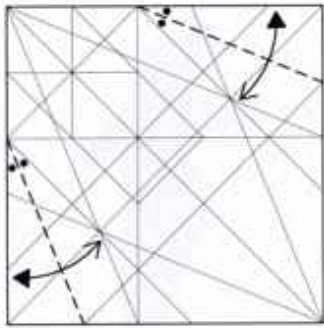

10.

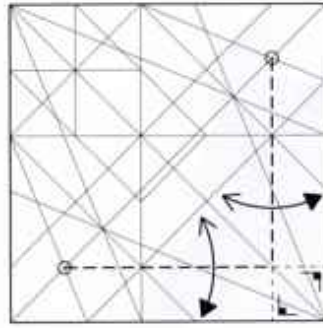

11.

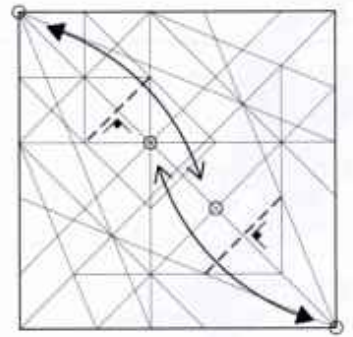

12.

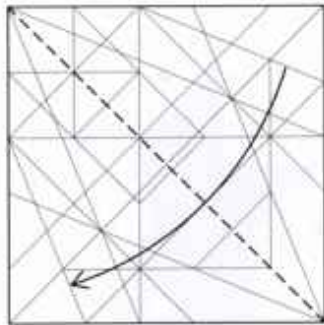

13.

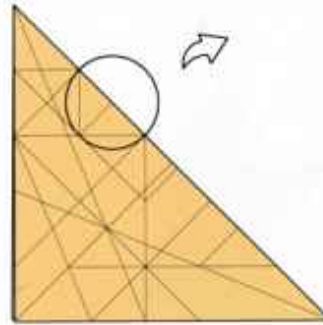

14.

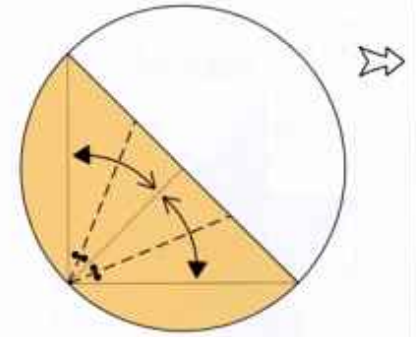

15.

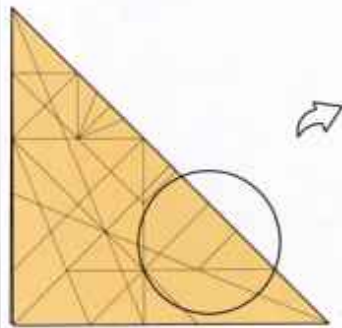

16.

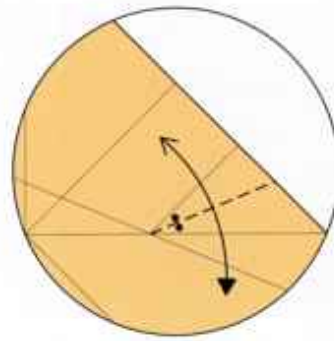

17.

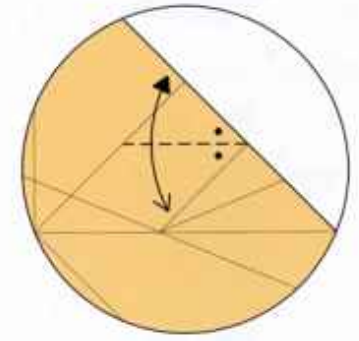

18.

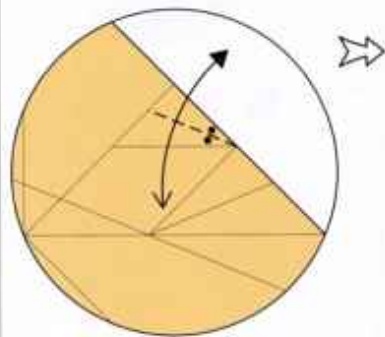

19.

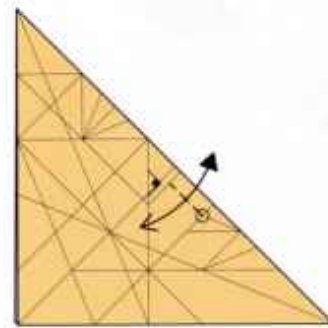

20.

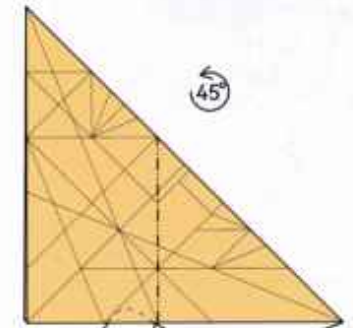

21.

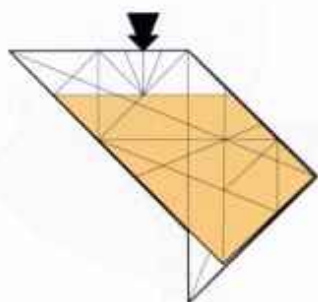

22. 开放沉折

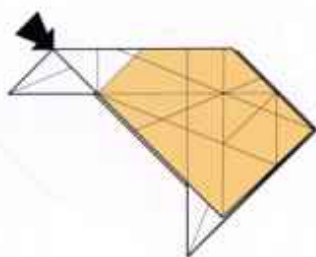

23. 开放沉折

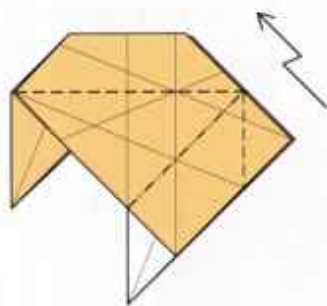

24.

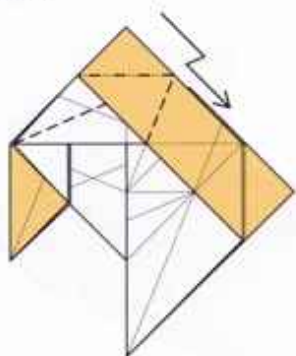

25. 旋转折

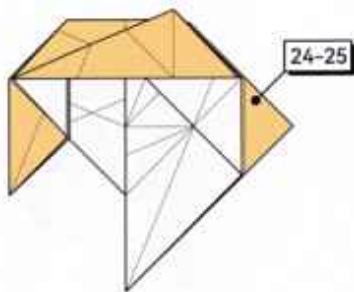

26.

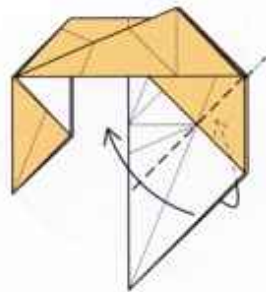

27. 外翻折

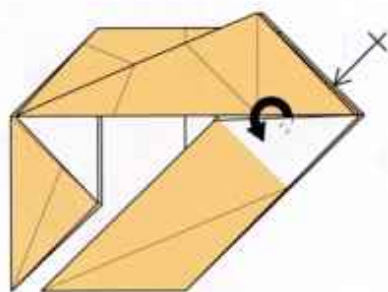

28.

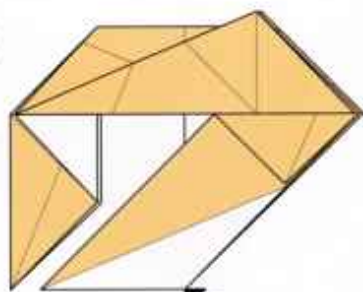

29. 开放沉折

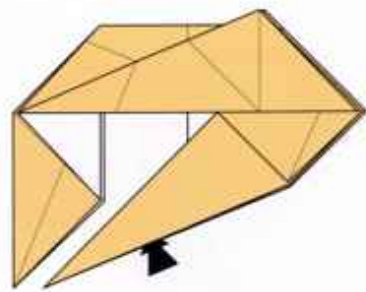

30. 打开纸层, 此时模型不压平

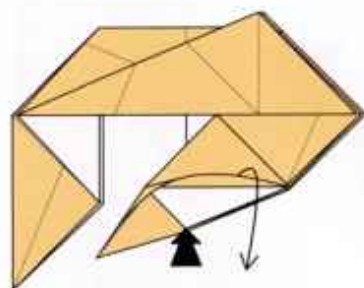

31. 开放沉折并压平

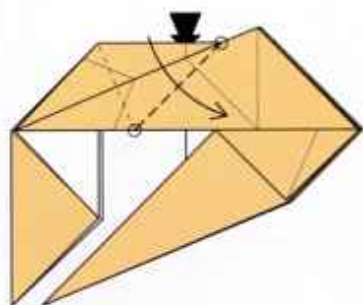

32. 打开纸层, 此时模型不压平

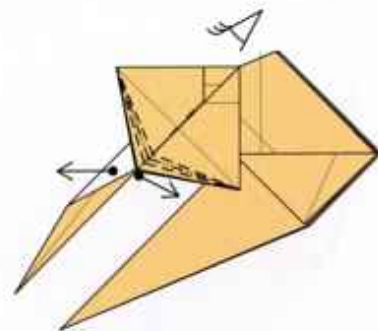

33. 按缝谷聚合并将两侧纸层向外拉开

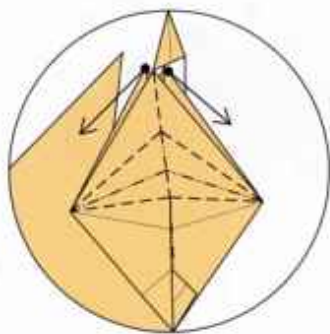

34.俯视图

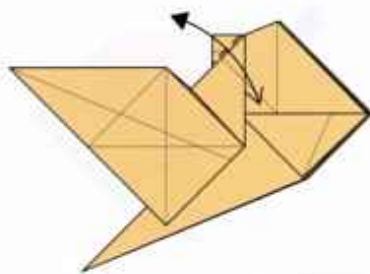

35.

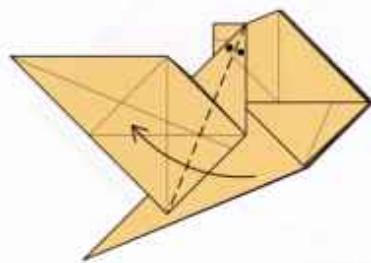

36.

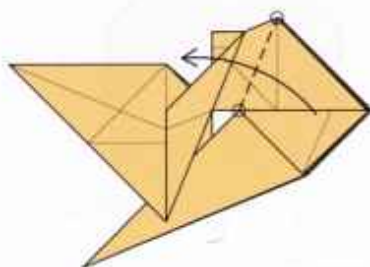

37.

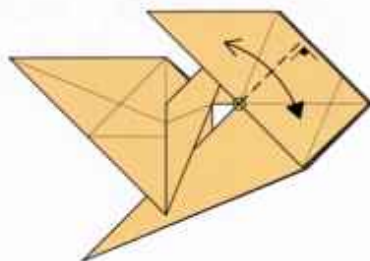

38.

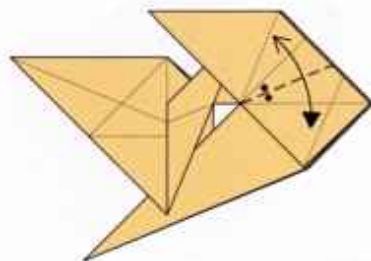

39.

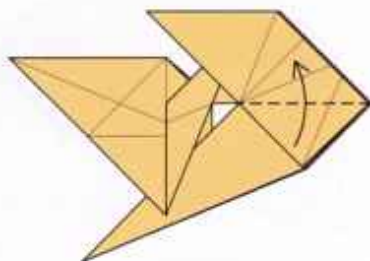

40.

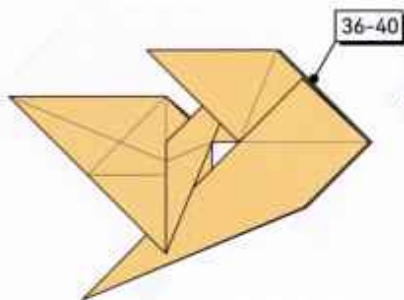

41.

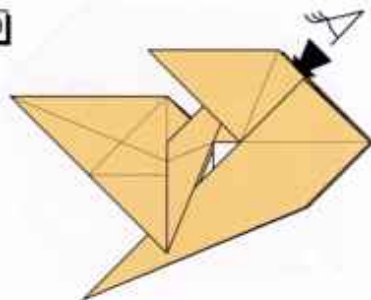

42.打开纸层, 此时模型不压平

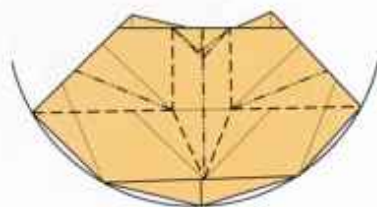

43.按峰谷聚合

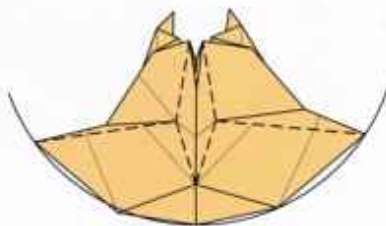

44.过程图

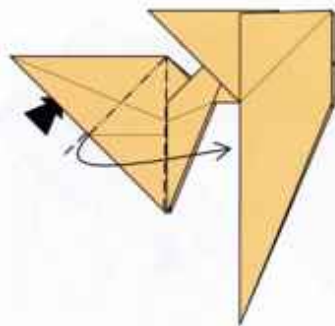

45.

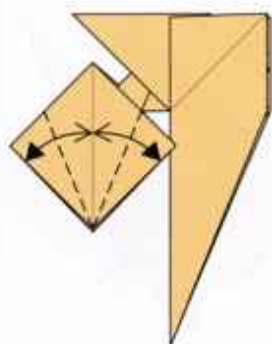

46.

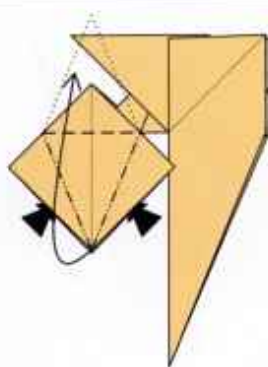

47.

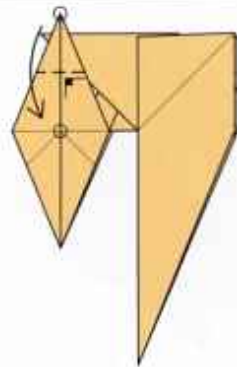

48.

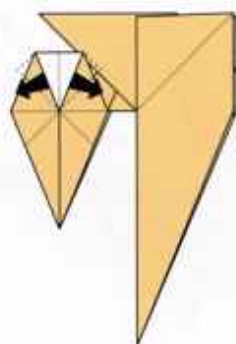

49.

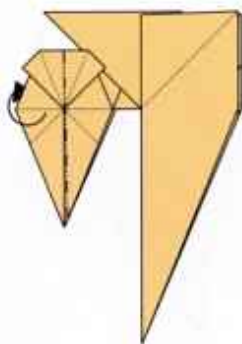

50.

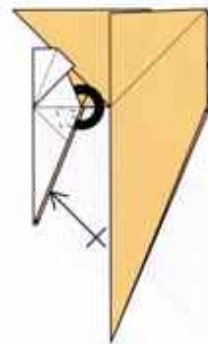

51.塞入内侧

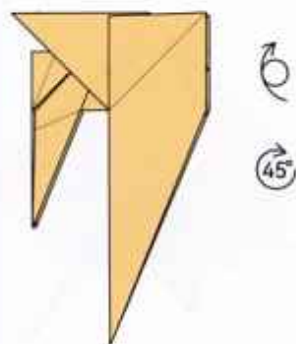

52.垂直旋转180°,再向右旋转45°

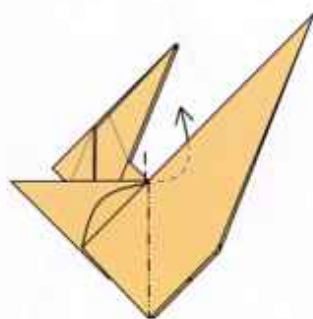

53.

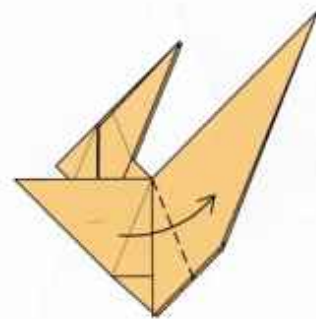

54.

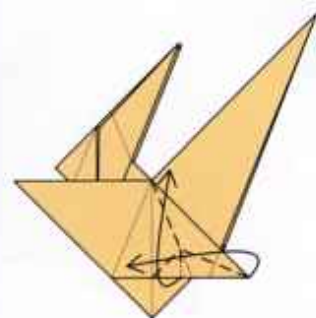

55.

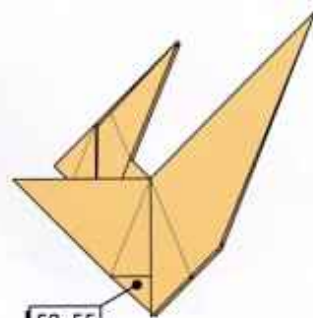

56.

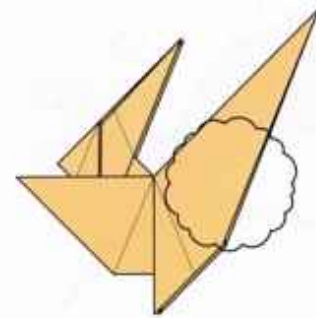

57.忽略尾巴表层

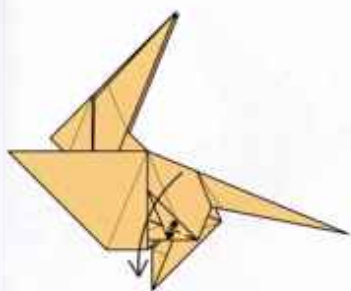

70.

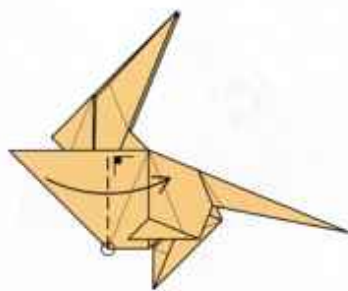

71.

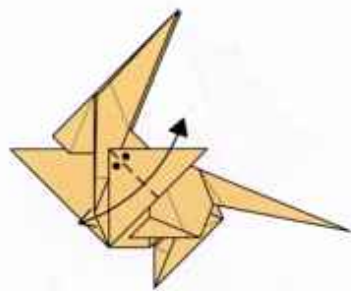

72.

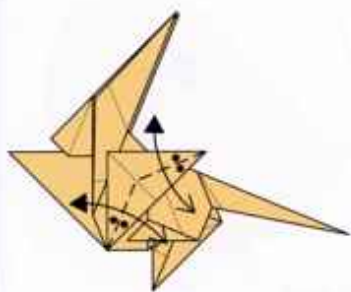

73.

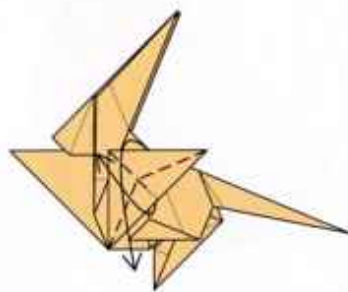

74.

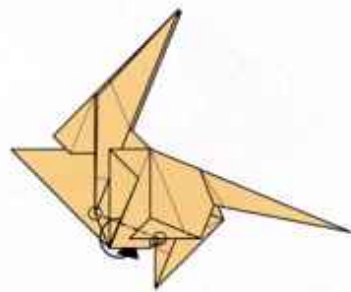

75.

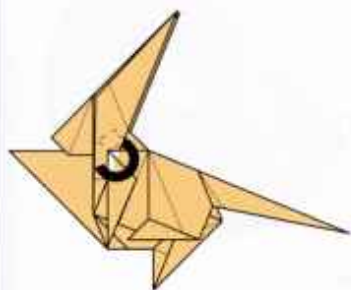

76.

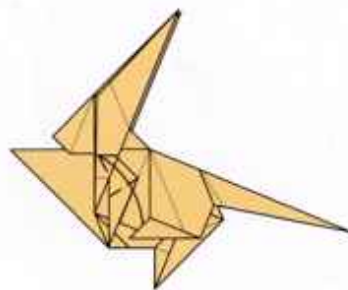

77.

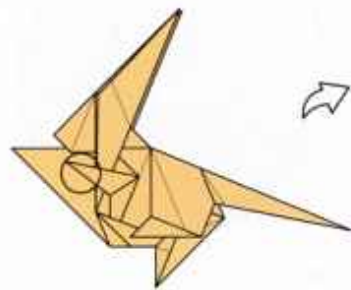

78.

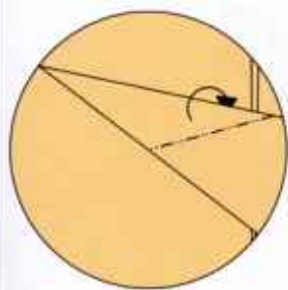

79.

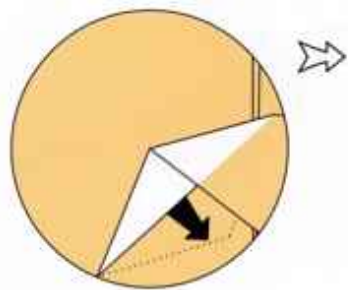

80.

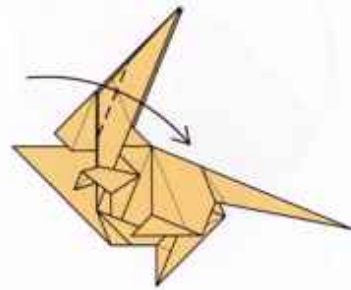

81.

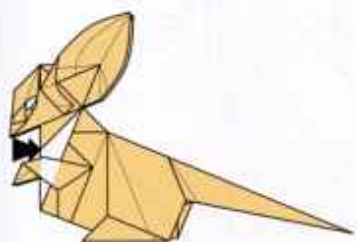

94. 将内侧正方形的上顶角沉折下去

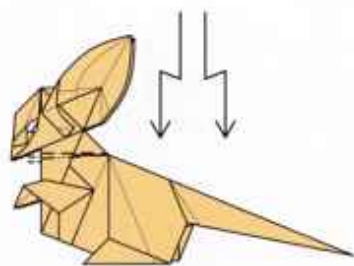

95.

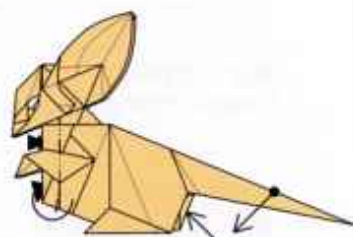

96. 两侧峰折进内侧并立体化身体

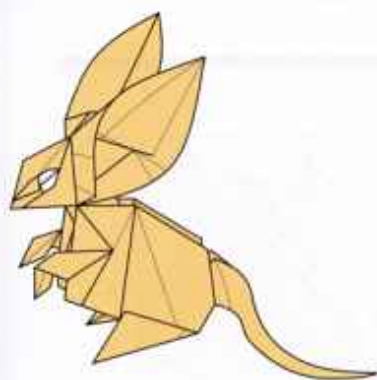

97.



# 手

Hand

设计: 孟伟凝

Design: Meng Weining

推荐用纸/Paper size:  
35cm教育折纸/kami  
5/2023

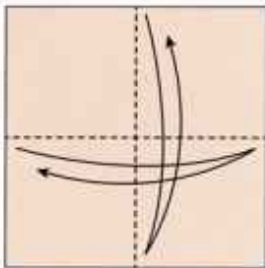
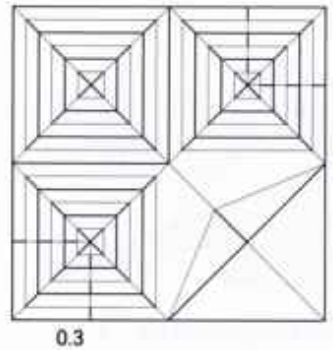
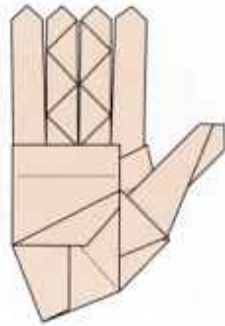

1

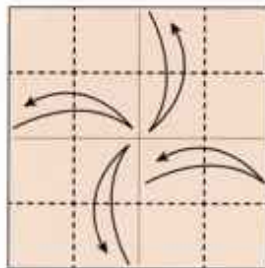

2

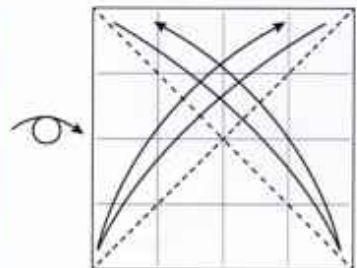

3

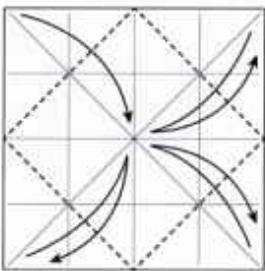

4

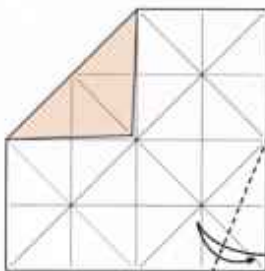

5

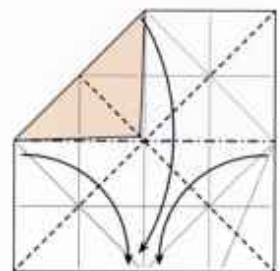

6

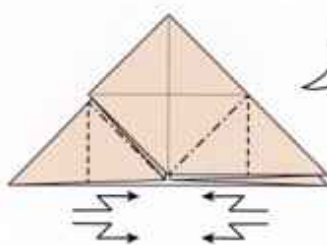

7

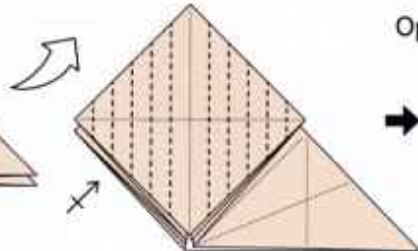

8

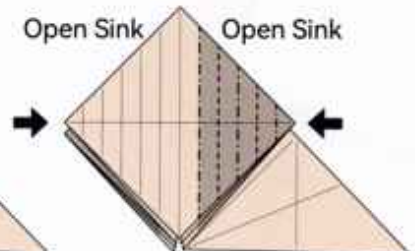

9

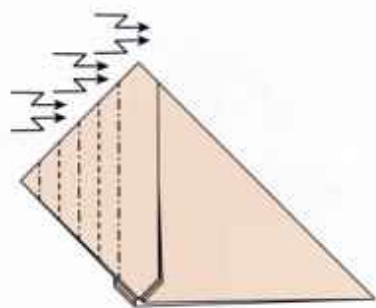

10

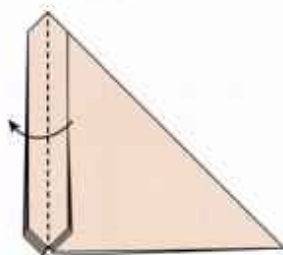

11

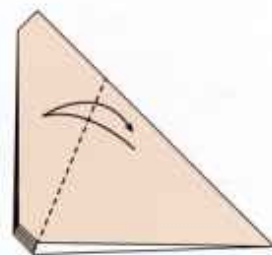

12

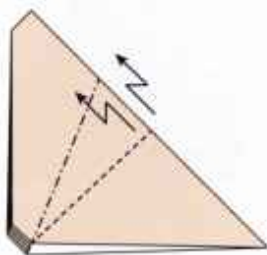

13

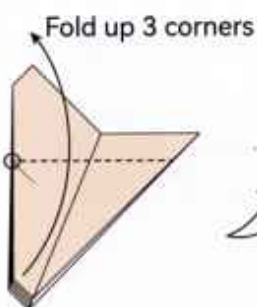

14

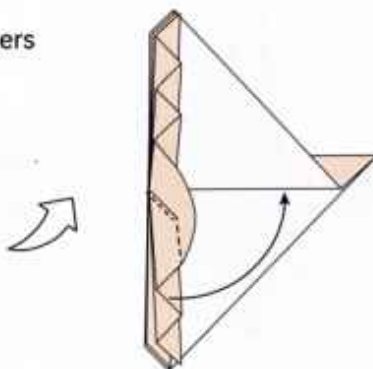

15

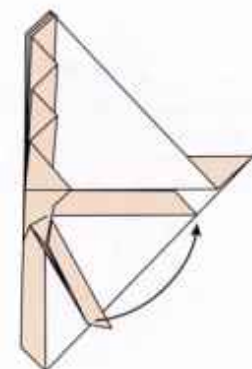

16

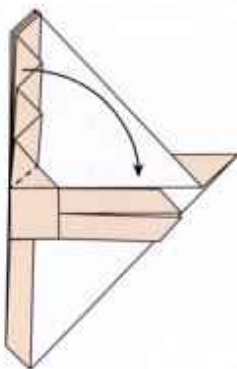

17

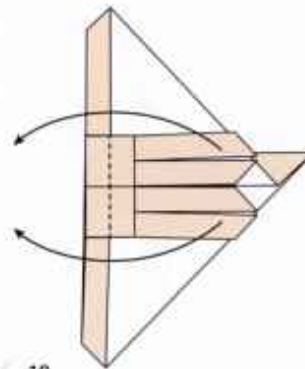

18

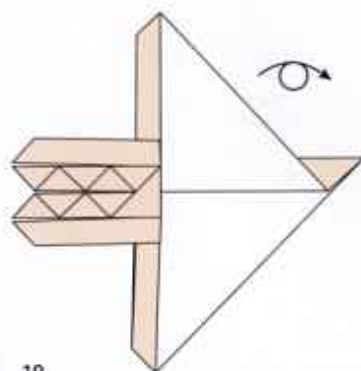

19

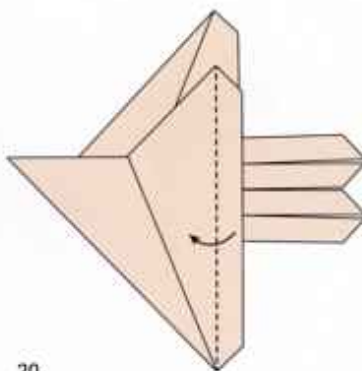

20

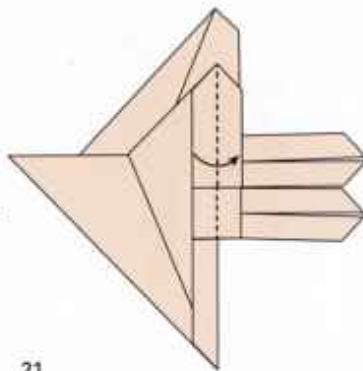

21

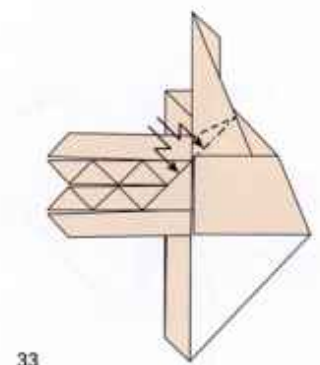
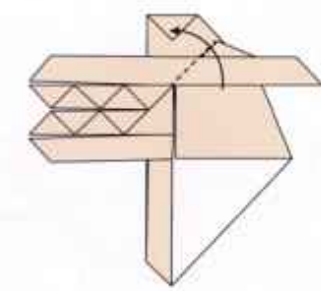
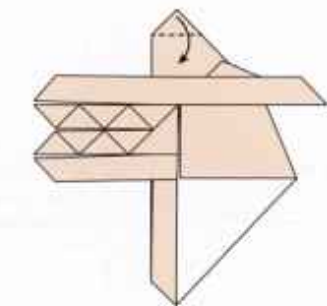
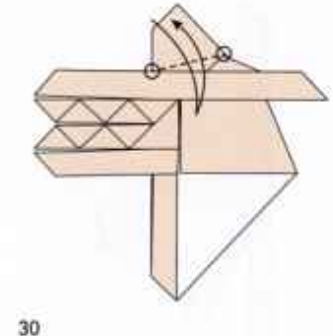
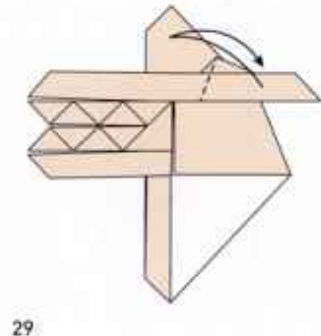
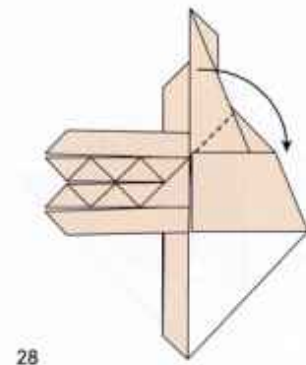
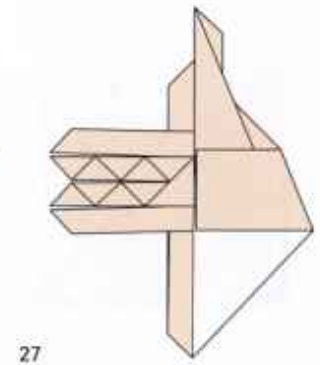
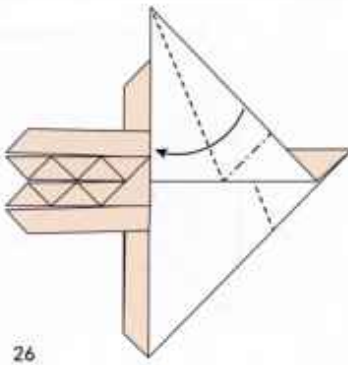
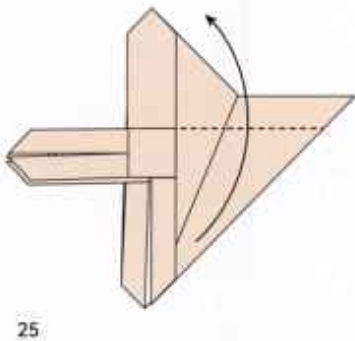
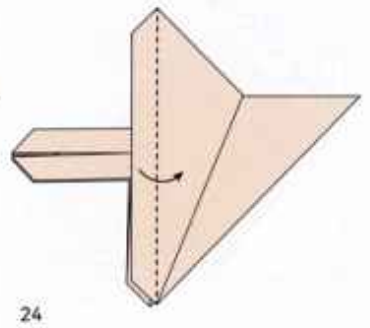
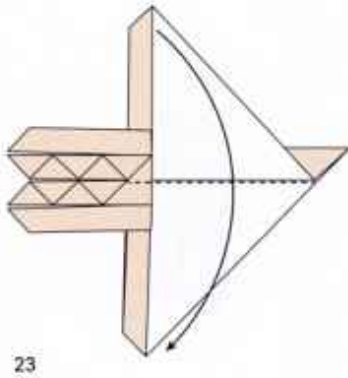
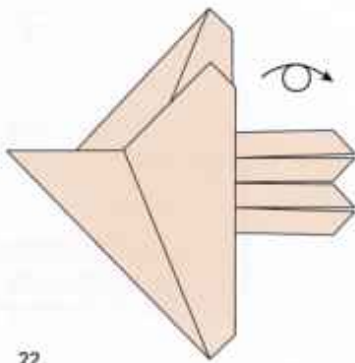

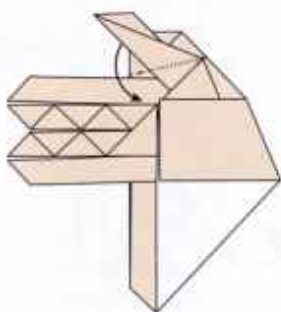

34

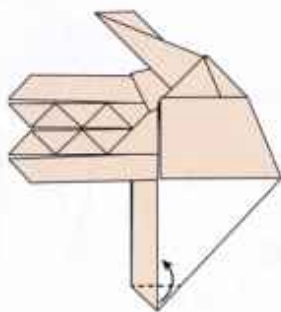

35

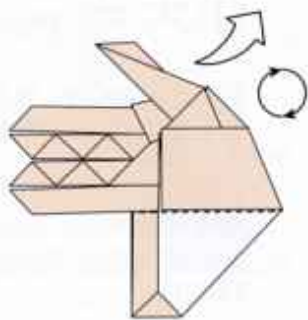

36

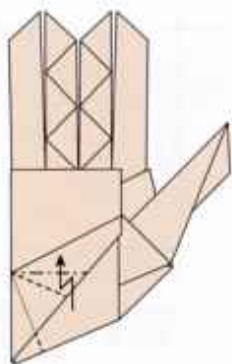

37

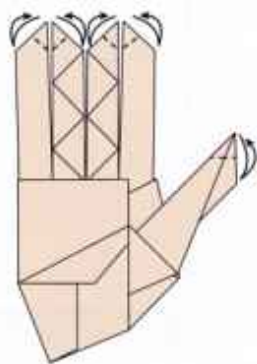

38

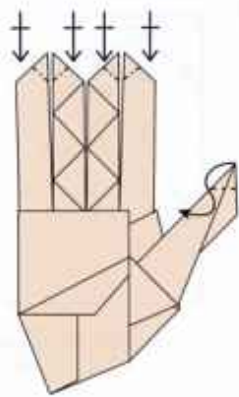

39

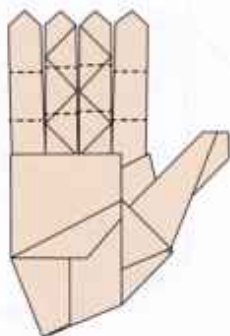

40

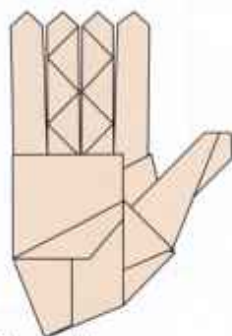

41 完成 complete

# 小天马 Pegasus

设计/Designed: 涂开明 Tukaiming  
 图示/Diagram: 银铃

推荐用纸/Paper size:  
 50cm教育折纸/kami/越前和纸  
 10/2023

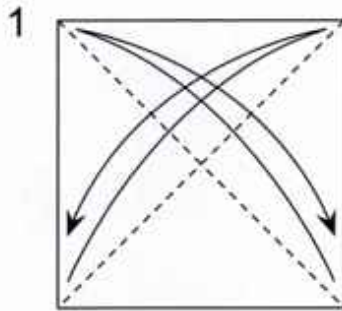
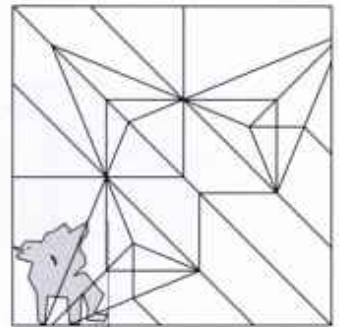

1 Fold the unfold,  
留下折痕

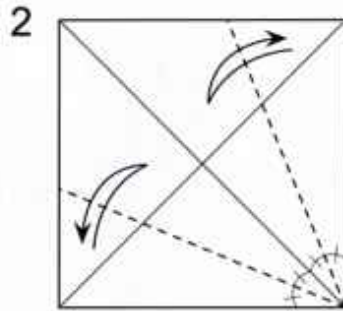

2 Fold along the angle bisectors.  
折出角平分线和中线的交点

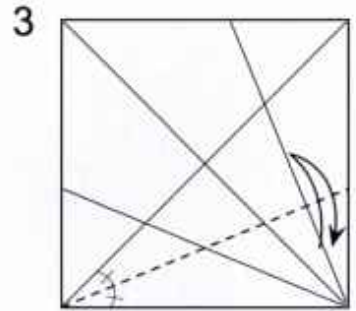

3 Fold along the angle bisectors.  
折出角平分线和中线的交点

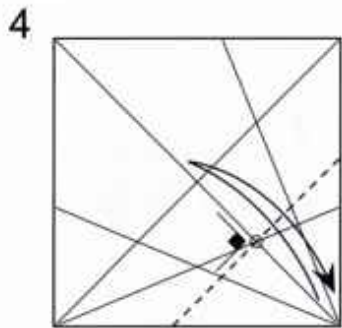

4 Fold the unfold.  
留下折痕

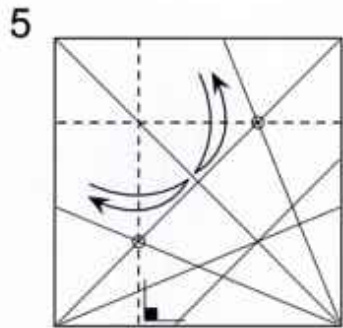

5 Fold the unfold.  
留下折痕

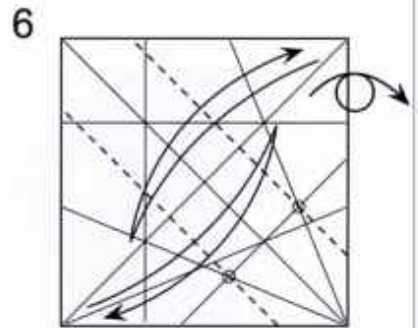

6 Turn over.  
翻面

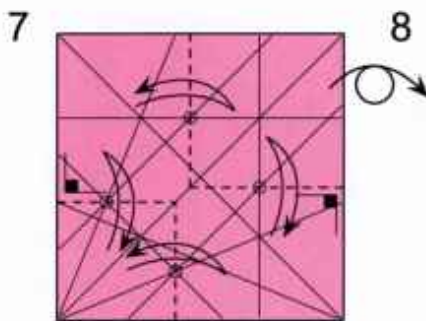

7 Turn over.  
翻面

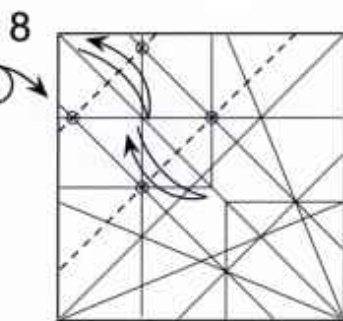

8 Fold the unfold.  
留下折痕

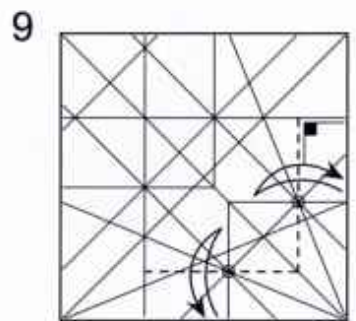

9 Fold the unfold.  
留下折痕

10

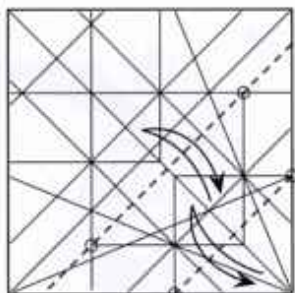

Fold the unfold.  
留下折痕

11

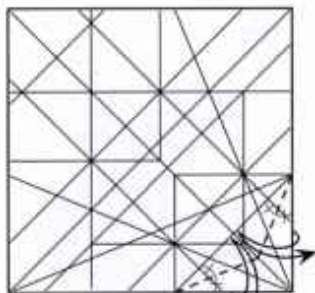

Fold along the angle bisectors.  
折出角平分线和中线的交点

12

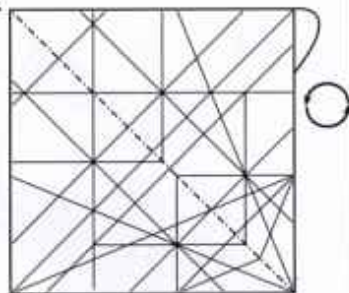

Mountain-fold.  
峰折

13

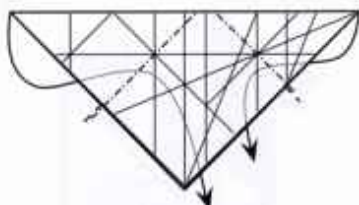

Inside reverse-fold.  
内翻折

14

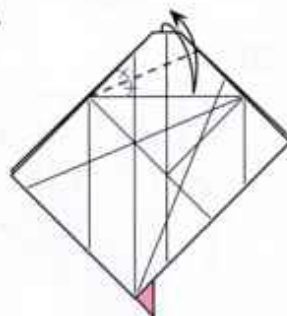

Fold along the angle bisectors.  
折出角平分线和中线的交点

15

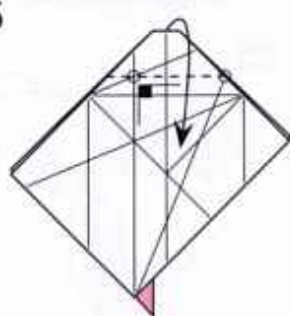

Valley-fold.  
谷折

16

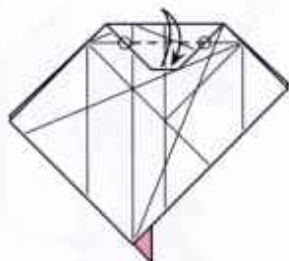

Fold the unfold.  
留下折痕

17

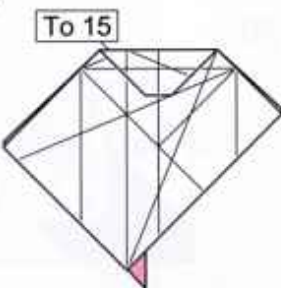

Unfold to step 15.  
复原至步骤15

18

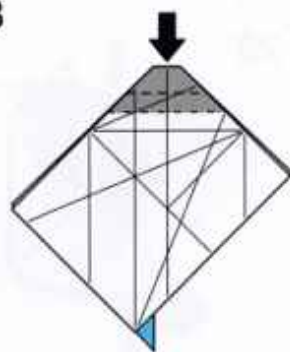

Open sink.  
开放沉折

19

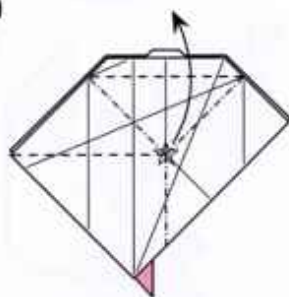

Pull up the point marked with ☆.  
将☆标注的点提上去

20

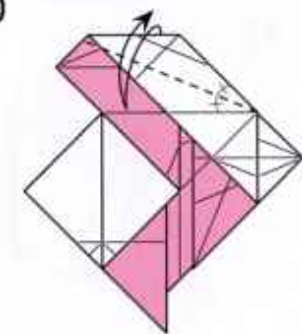

Fold along the angle bisectors.  
折出角平分线和中线的交点

21

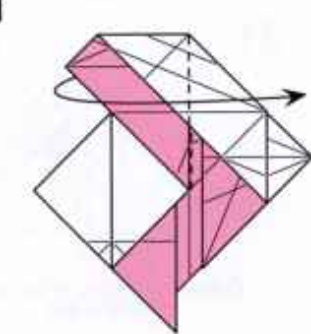

Fold one layer to the right.  
向右谷折一层

22

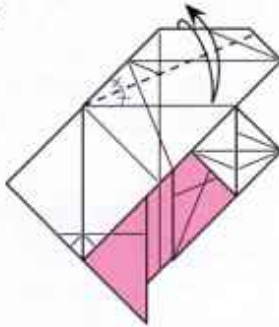

Fold along the angle bisectors.  
折出角平分线和中线的交点

23

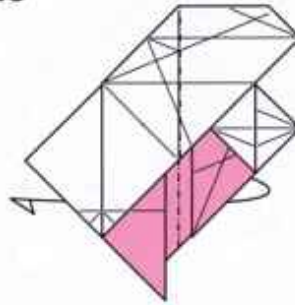

Mountain-fold.  
峰折

24

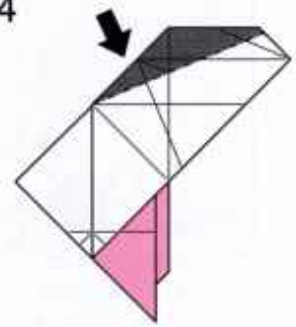

Open sink.  
开放沉折

25

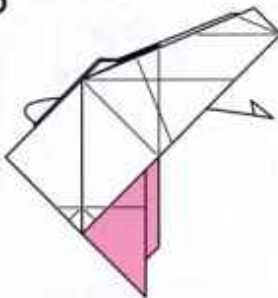

Fold the layers to the right.  
向右谷折

26

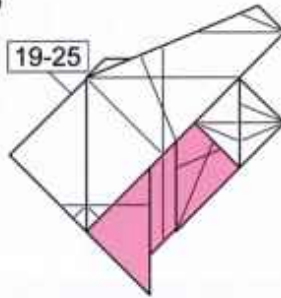

Repeat step 19 to 25 on the other side.  
另一侧重复步骤19-25

27

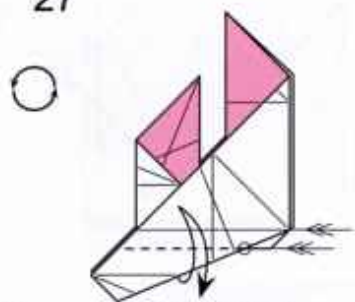

Fold the unfold.  
留下折痕

28



Open sink.  
开放沉折

29

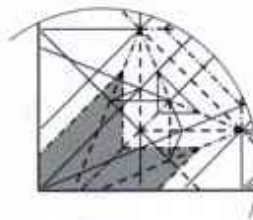

Collapse according to the creases.  
按峰谷聚合

30

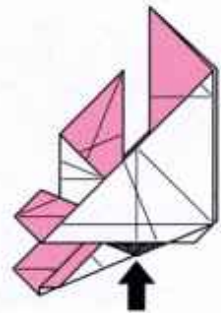

Open sink.  
开放沉折

31

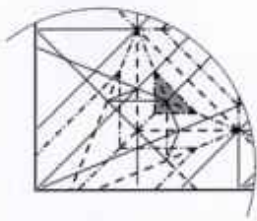

Collapse according to the creases.  
按峰谷聚合

32



Fold the unfold.  
留下折痕

33

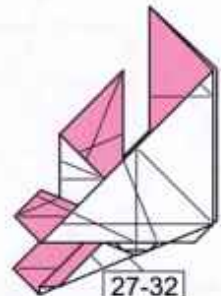

Repeat step 27 to 32 on the other side.  
另一侧重复步骤27-32

34

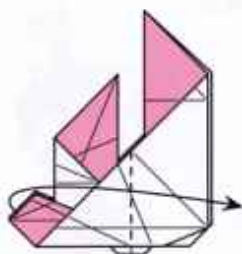

Fold the flap to the right.  
向右谷折

35

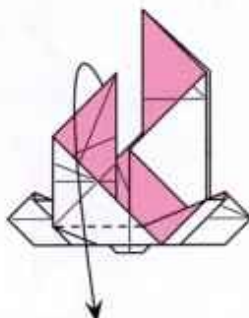

Valley-fold.  
谷折

36

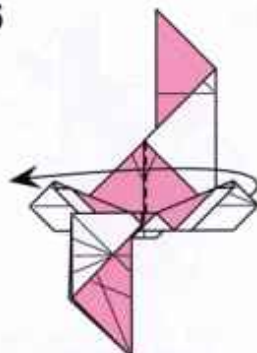

Fold the flap to the left.  
向左谷折

37

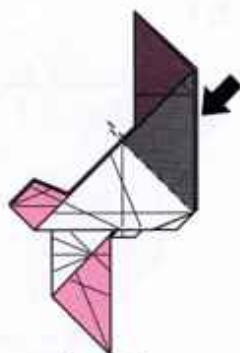

Open sink.  
开放沉折

38

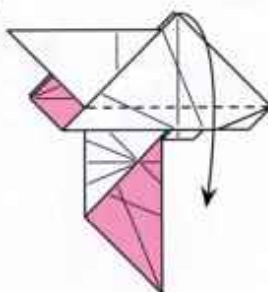

Valley-fold.  
谷折

39

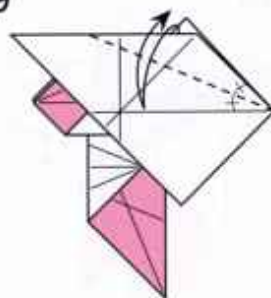

Fold along the angle bisectors.  
折出角平分线和中线的交点

40

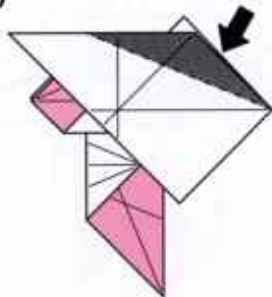

Open sink.  
开放沉折

41

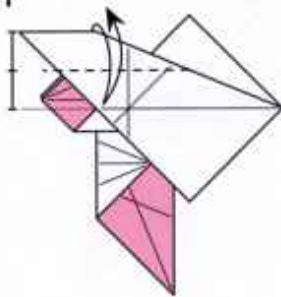

Fold the unfold.  
留下折痕

42

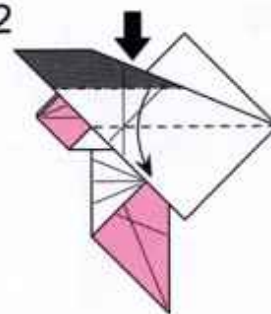

Spread sink.  
延展沉折

43

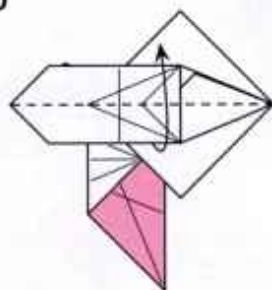

Valley-fold.  
谷折

44

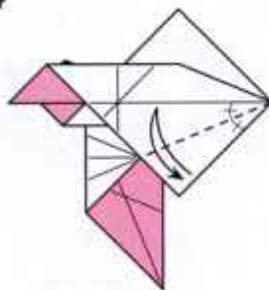

Fold along the angle bisectors.  
折出角平分线和中线的交点

45

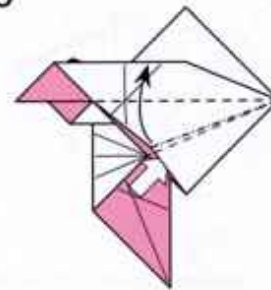

Squashfold.  
撑开压平



46

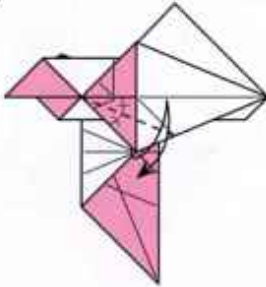

Fold along the angle bisectors.  
折出角平分线和中线的交点

47

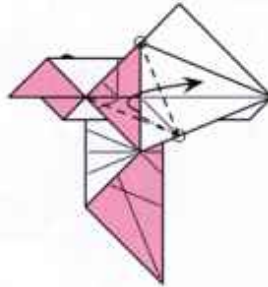

Swivel-fold.  
旋转折

48

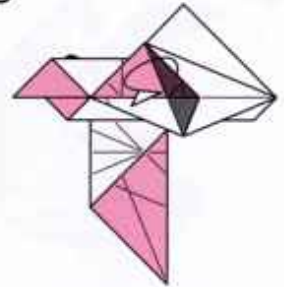

Tuck the shaded area inside.  
将阴影调整至内部

49

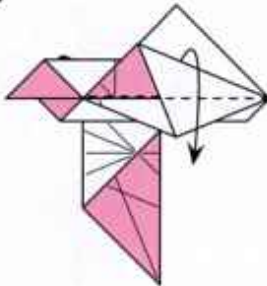

Valley-fold.  
谷折

50

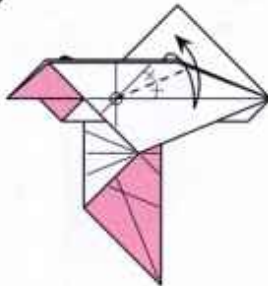

Fold along the angle bisectors.  
折出角平分线和中线的交点

51

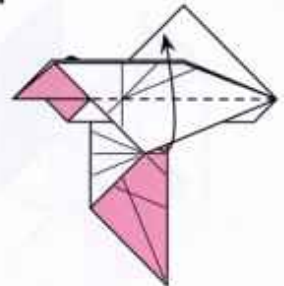

Valley-fold.  
谷折

52

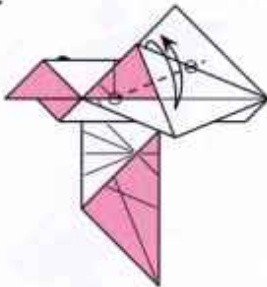

Fold the unfold.  
留下折痕

53

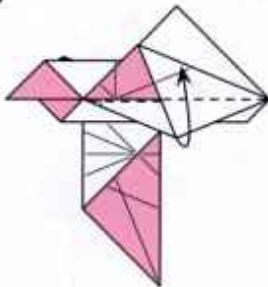

Valley-fold.  
谷折

54

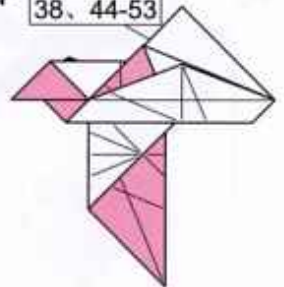

Repeat step 38, 44 to 53 behind.  
后侧重复步骤44-53

55

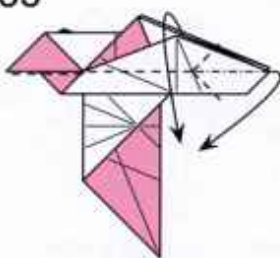

Collapse according to the creases.  
按峰谷聚合

56

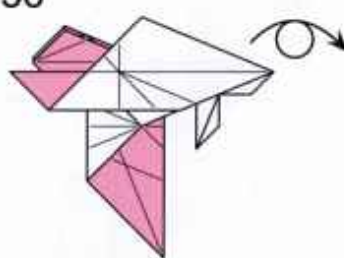

Turn over.  
翻面

57

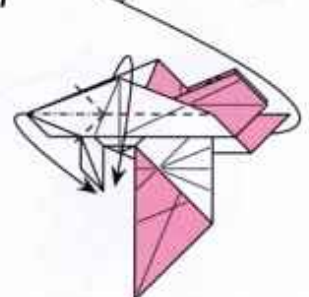

Collapse according to the creases.  
按峰谷聚合

70

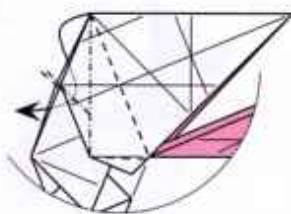

Inside reverse-fold.  
The model will not stay flat.  
内翻折, 模型无法压平

71

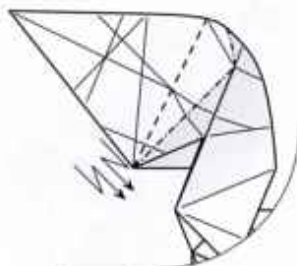

Collapse along the crease  
and flatten the model.  
按峰谷聚合, 压平模型

72

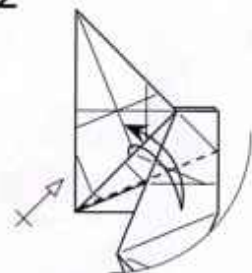

Fold the unfold. Repeat behind.  
留下折痕, 后侧重复

73

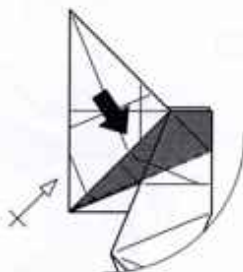

Closed sink. Repeat behind.  
闭合沉折, 后侧重复

74

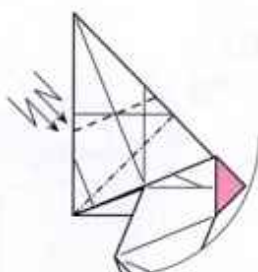

Crimp.  
双向段折

75

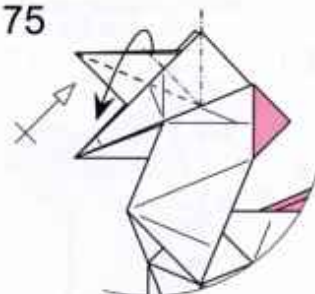

Swivel-fold. Repeat behind.  
旋转折, 后侧重复

76

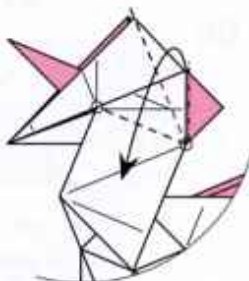

Swivel-fold.  
旋转折

77



Rabbit-ear fold.  
兔耳折

78



Bring the hidden layers to the front.  
将纸层调整至表面

79



Pleat-fold.  
段折

80

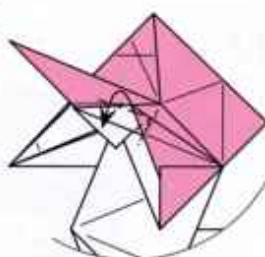

Swivel-fold.  
旋转折

81



Repeat step 76 to 80 on the other side.  
另一侧重复步骤76-80

82



Open the layer and pull the corner up.  
打开纸层并将纸角上拉

83

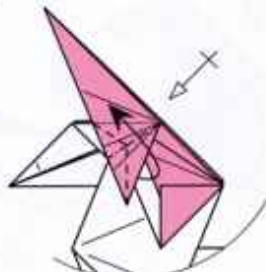

Rabbit-ear fold.Repeat behind.  
兔耳折, 后侧重复

84

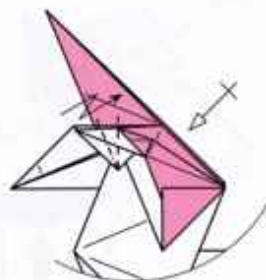

Pleat-fold.Repeat behind.  
段折, 后侧重复

85

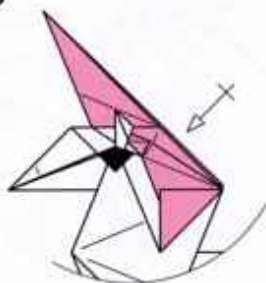

Adjust the layers.  
调整纸层位置

86

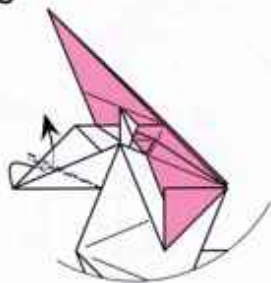

Inside reverse-fold.  
内翻折

87

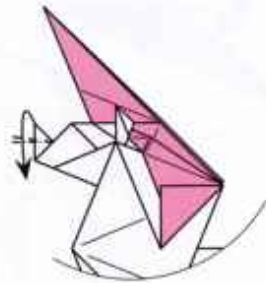

Inside reverse-fold.  
内翻折

88

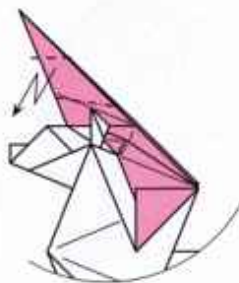

Pleat-fold.  
段折

89

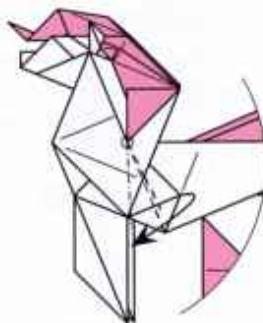

Swivel-fold.  
旋转折

90



Pull out the hidden layer.  
引出内部纸层

91

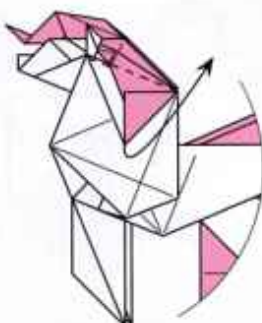

Fold the layer up.  
将纸层向上折

92

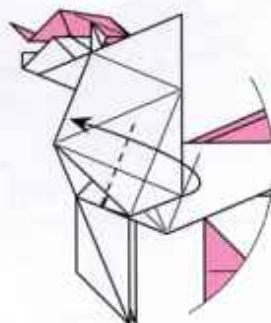

Valley-fold.  
谷折

93

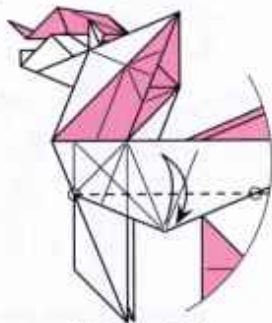

Fold the unfold.  
留下折痕

106

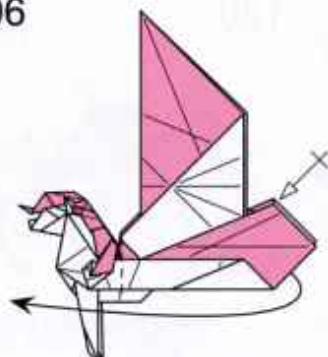

Valley-fold. Repeat behind.  
谷折, 后侧重复

107

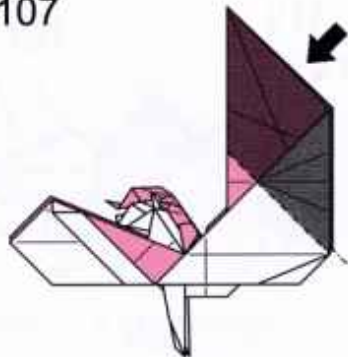

Open sink.  
开放沉折

108

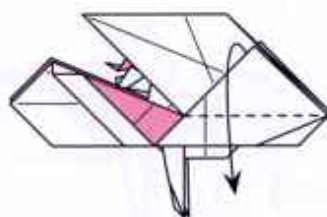

Valley-fold.  
谷折

109

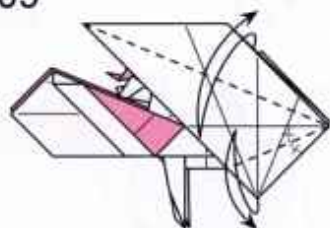

Fold along the angle bisectors.  
折出角平分线和中线的交点

110

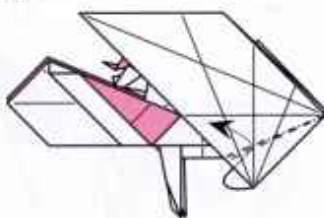

Inside reverse-fold.  
内翻折

111

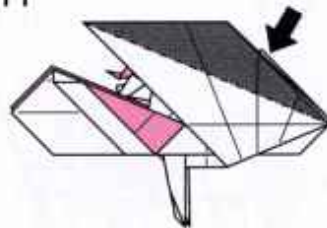

Open sink.  
开放沉折

112

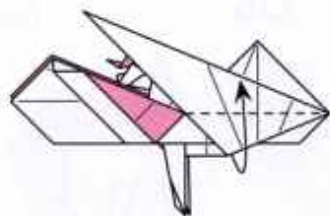

Valley-fold.  
谷折

113

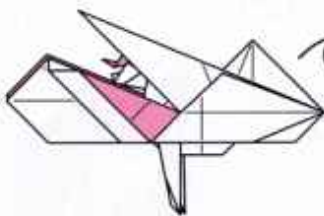

Turn over.  
翻面

114

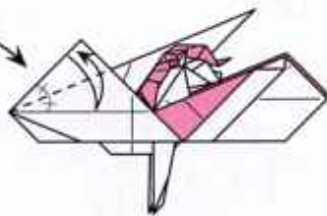

Fold along the angle bisectors.  
折出角平分线和中线的交点

115

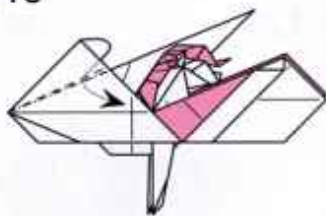

Inside reverse-fold.  
内翻折

116

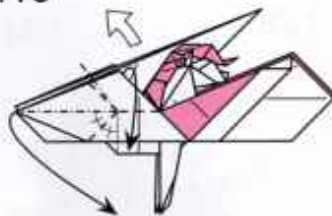

Collapse according to the creases.  
按峰谷聚合

117

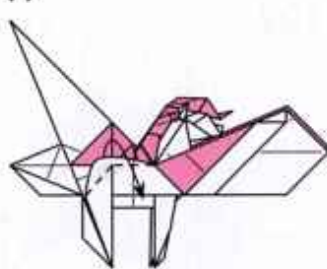

Flatten.  
压平

118

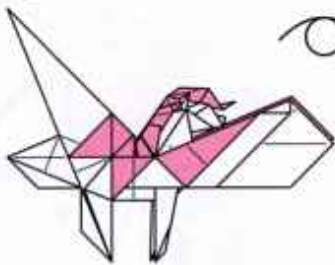

Turn over.  
翻面

119

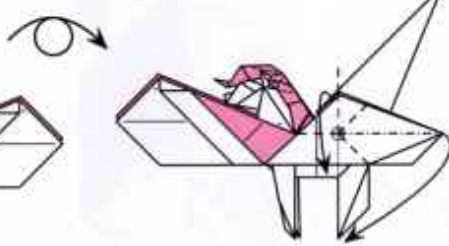

Collapse according to the creases.  
按峰谷聚合

120

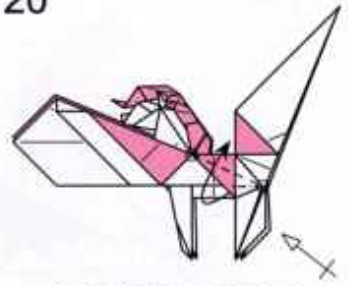

Swivel-fold. Repeat behind.  
旋转折, 后侧重复

121

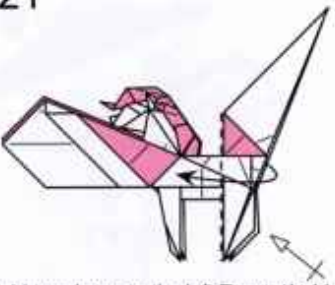

Fold two layer to the left. Repeat behind.  
向左谷折一层, 后侧重复

122



Outside reverse-fold.  
Open sink the middle layer.  
Zoom in.  
外翻折, 中间纸层开放沉折  
局部视图放大

123

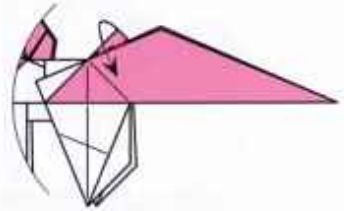

Inside reverse-fold.  
内翻折

124

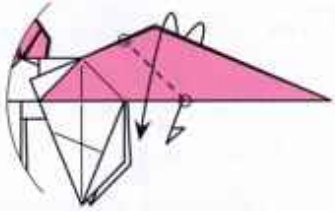

Outside reverse-fold.  
外翻折

125



Inside reverse-fold.  
内翻折

126

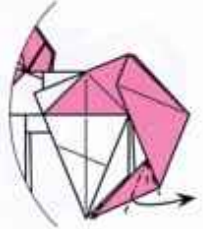

Swivel-fold.  
旋转折

127

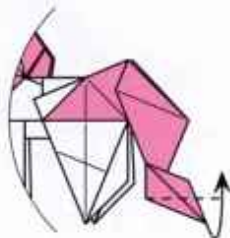

Valley-fold.  
谷折

128

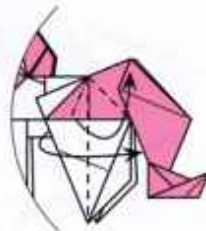

Swivel-fold.  
旋转折

129

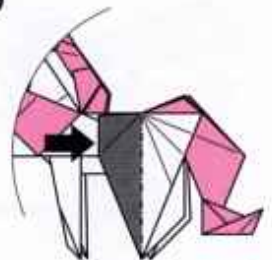

Closed sink.  
闭合沉折

130

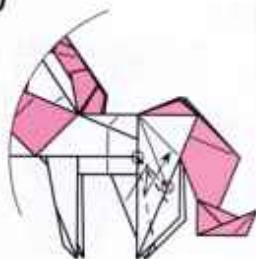

Swivel-fold.  
旋转折

131



Mountain-fold.  
峰折

132



Mountain-fold.  
峰折

133



Mountain-fold.  
峰折

134

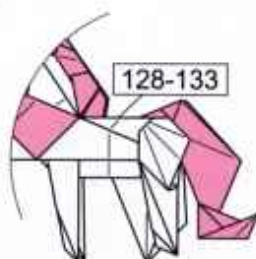

Repeat step 128 to 133 behind.  
后重复步骤128-133

135



Fold the flap to the right.  
Repeat behind.  
向右谷折, 后侧重复

136

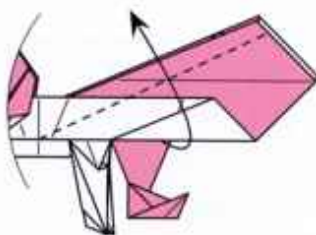

Valley-fold.  
谷折

137

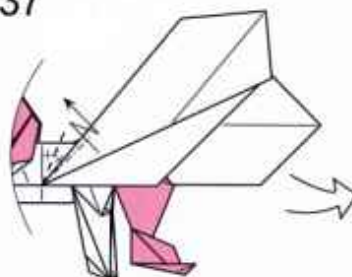

Pleat-fold.  
段折

138

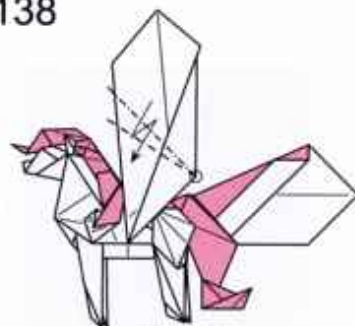

Pleat-fold.  
段折

139

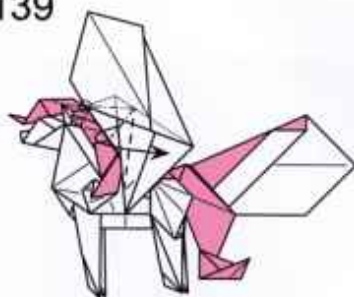

Swivel-fold.  
旋转折

140

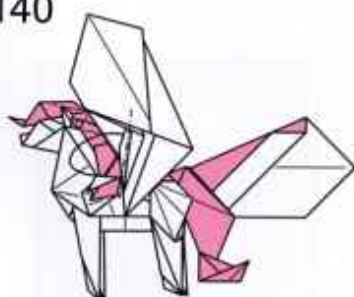

Mountain-fold.  
峰折

141

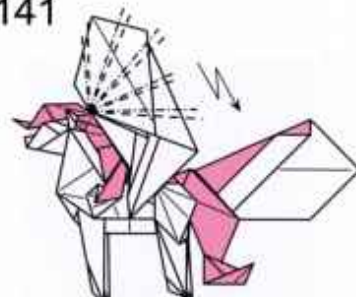

Pleat-fold.  
段折

142

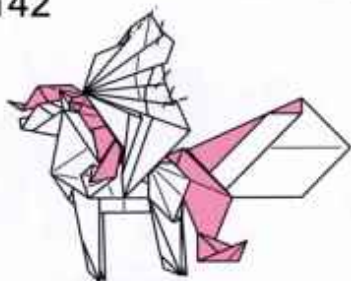

Shape the wing.  
整形翅膀

143

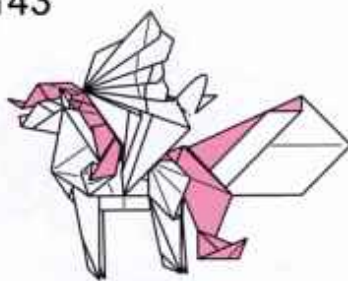

Mountain-fold.  
峰折

144

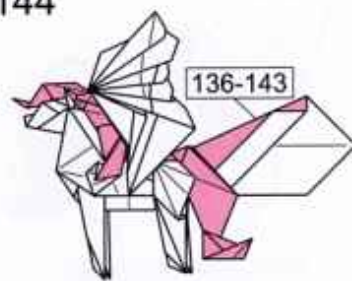

Repeat step 136 to 143 behind.  
后重复步骤136-143

145



Complete!  
完成!

# 背带长绒魮 *Ablabys taenianotus*

设计/Designed: 张义帆 Zhang Yifan

推荐用纸/Paper size:  
24cm 和纸miogami/生态纸biotope

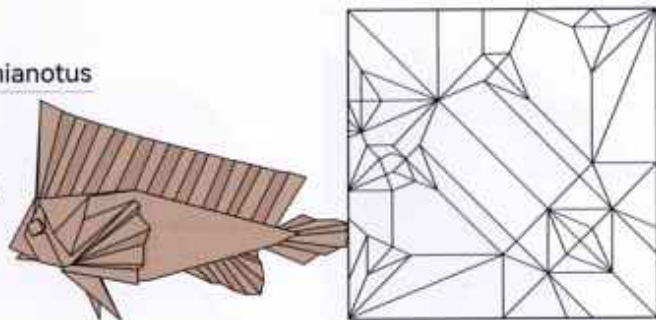

1

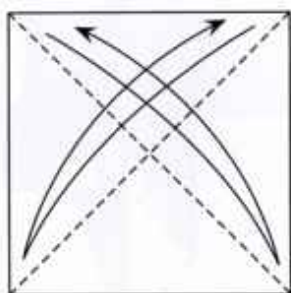

2

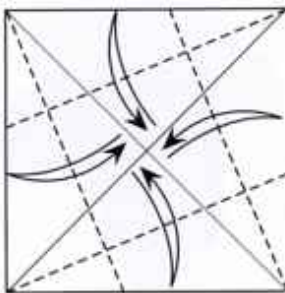

3

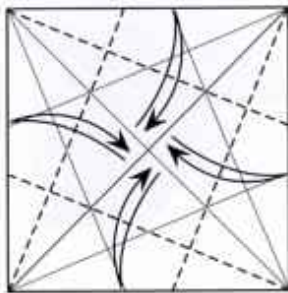

4

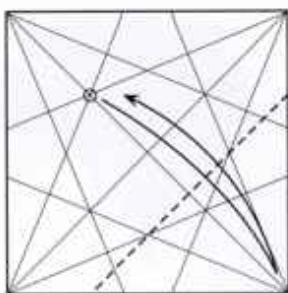

5

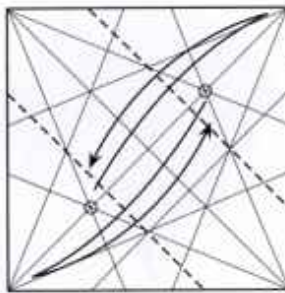

6

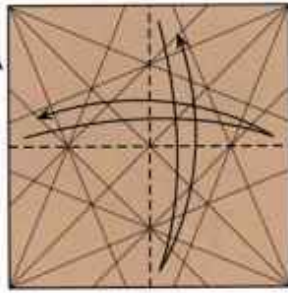

7

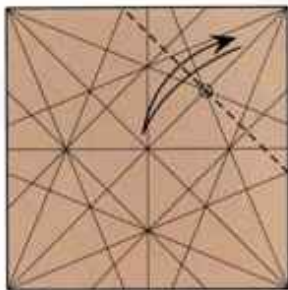

8

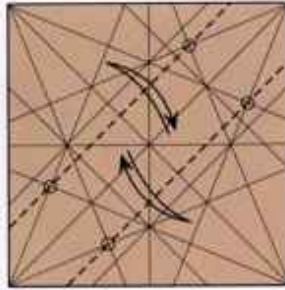

9

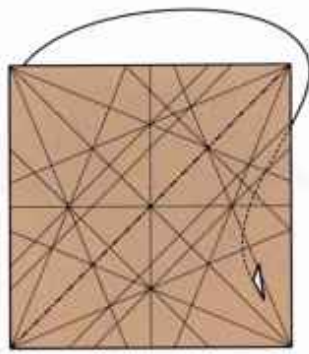



10

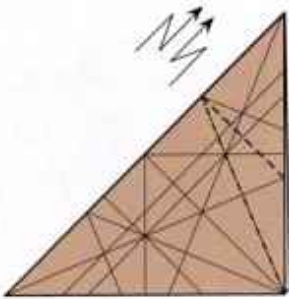

11

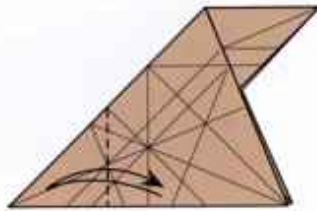

12

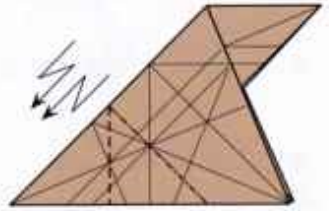

13



14

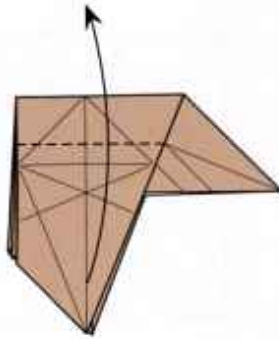

15

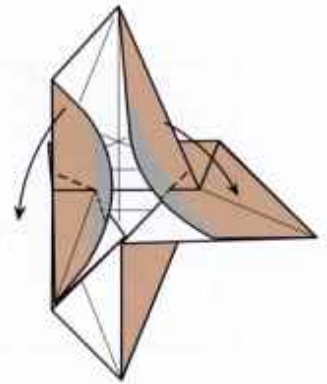

16

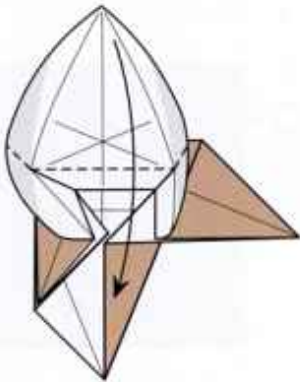

17

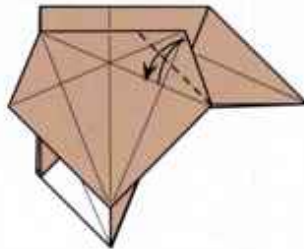

18

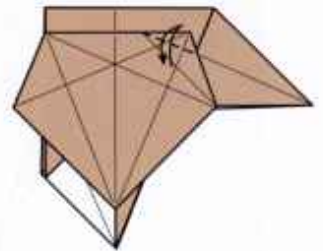

19

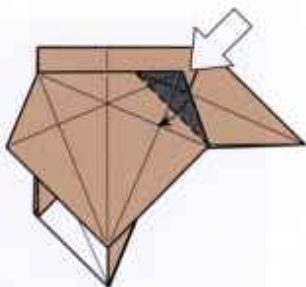

20

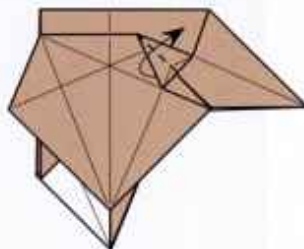

21

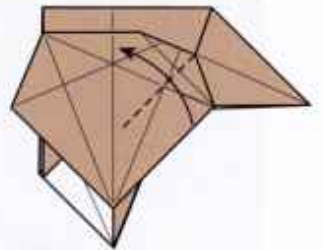

22

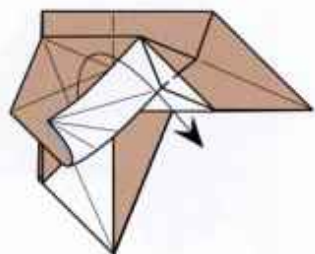

23

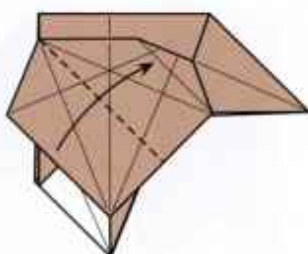

24

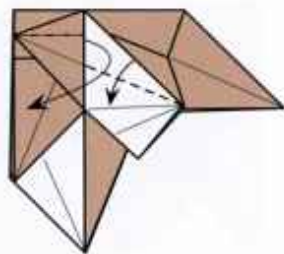

25

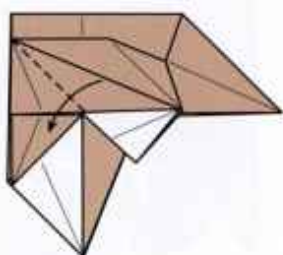

26

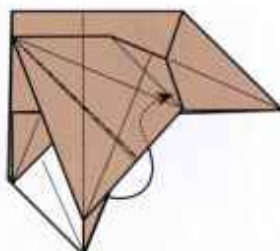

27

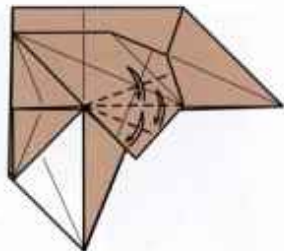

28

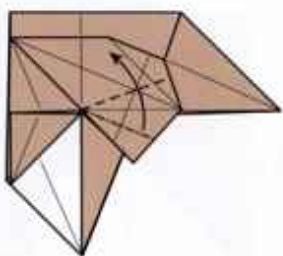

29

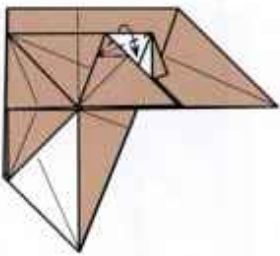

30

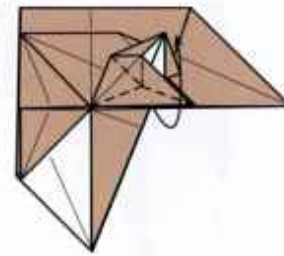

31

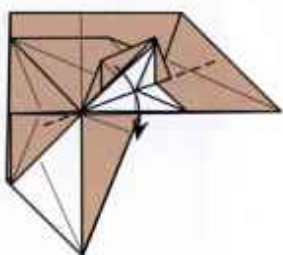

32

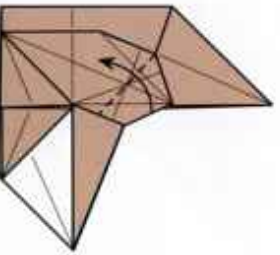

33

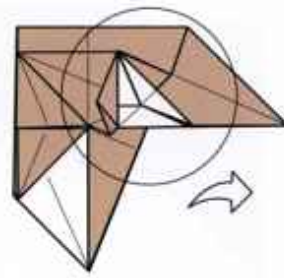

34

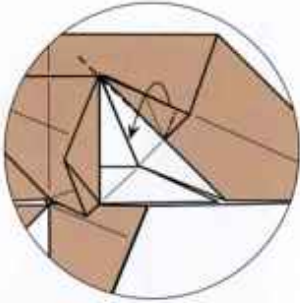

35

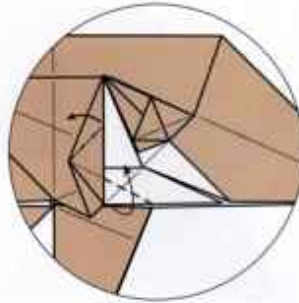

36

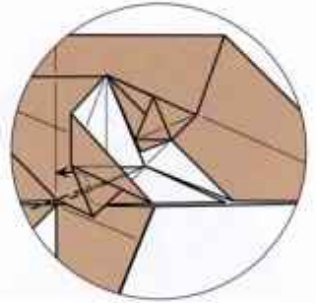

37

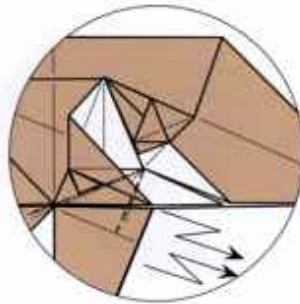

38

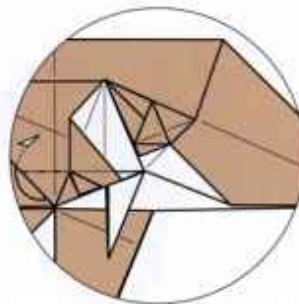

39

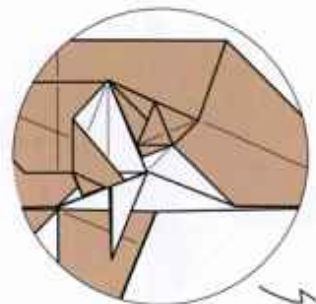

40

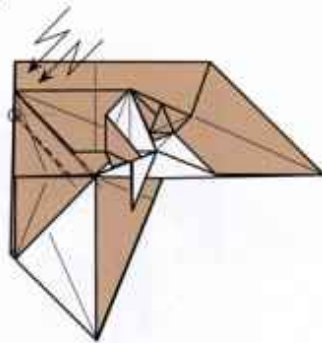

41

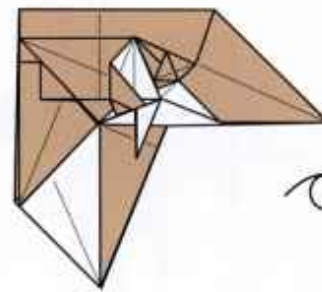

42

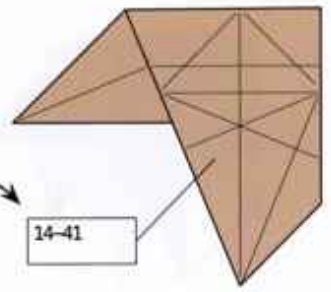

43

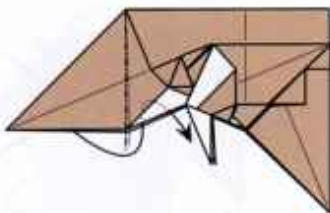

44

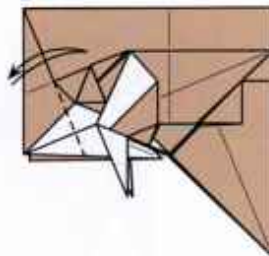

45

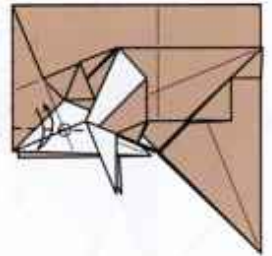

58

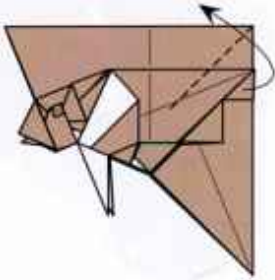

59

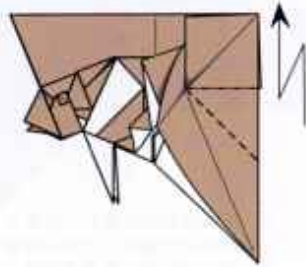

60

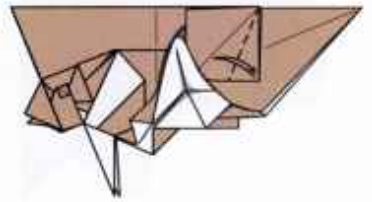

61

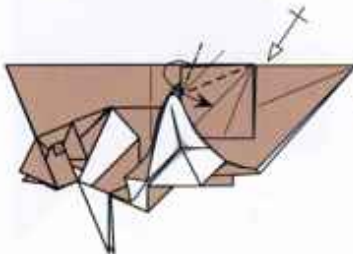

背面不要忘记-

62

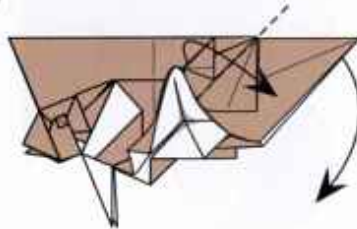

63

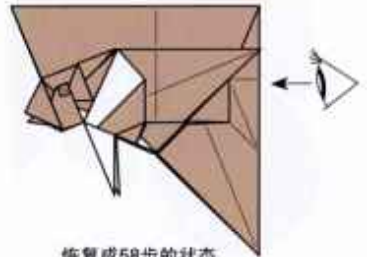

恢复成58步的状态

64

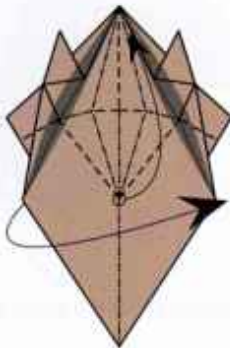

65

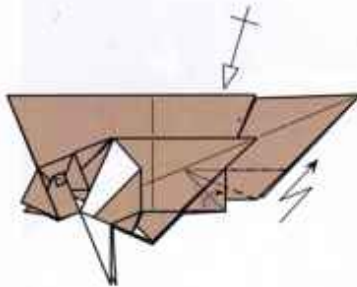

66

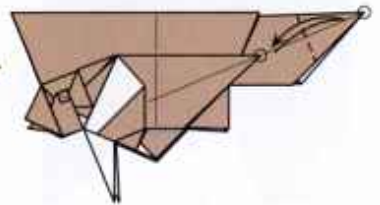

67

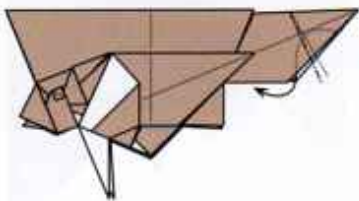

68

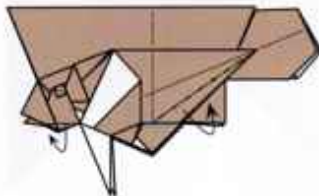

69

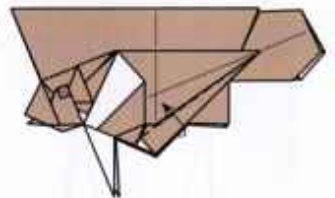

70

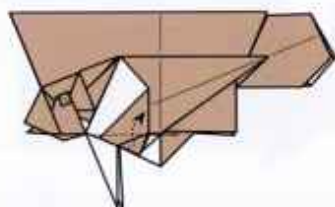

71

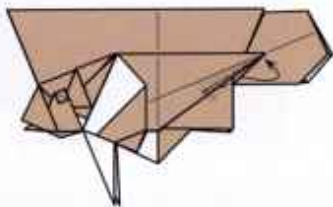

72

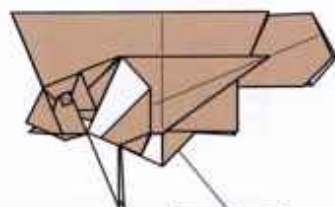

68-71

73

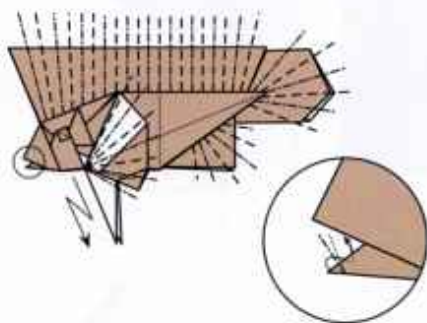

74

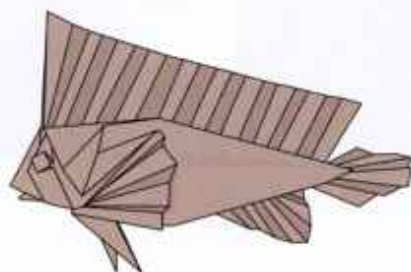

完成!

尾鳍和背鳍的根部请自行发挥折窄。

若没有对47步的旋转折作出修改。  
可在此时将眼睛往前搓一下。

# 蝠鲼 Manta

设计/Designed: St  
 图示/Diagram: St

推荐用纸/Paper size:  
 35cm教育折纸/kami

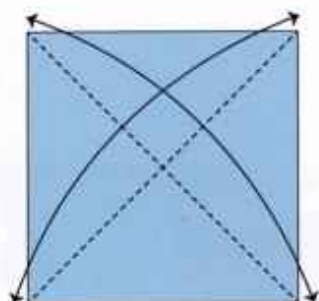
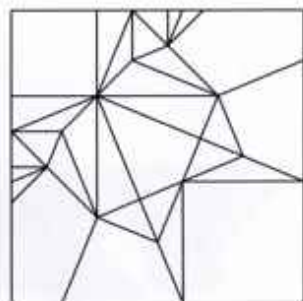
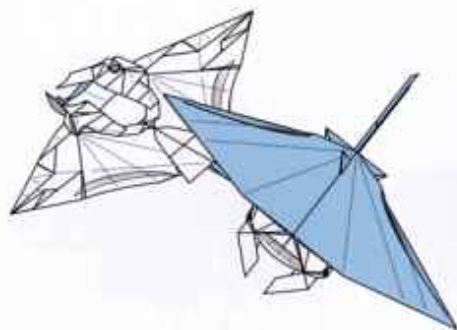

1

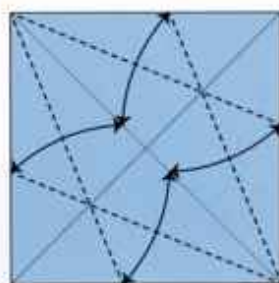

2

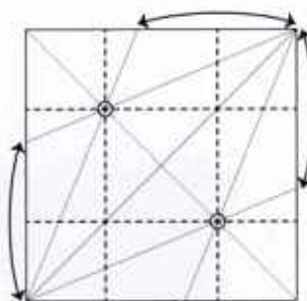

3

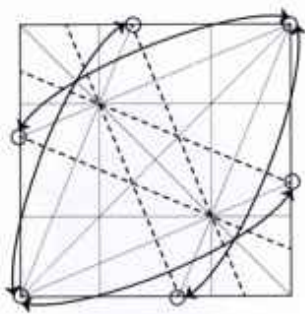

4

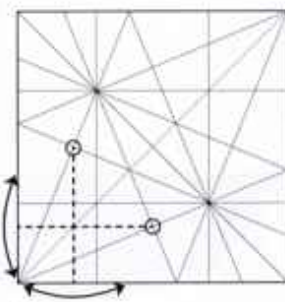

5

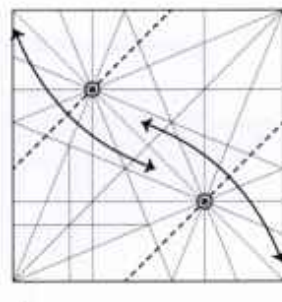

6

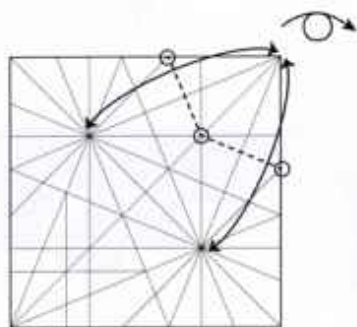

7

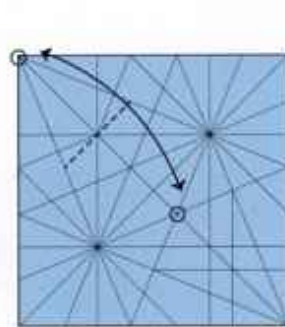

8

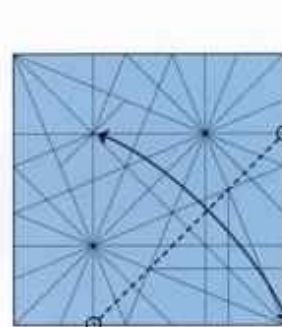

9

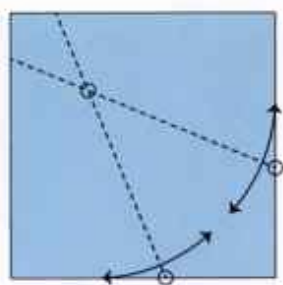

10

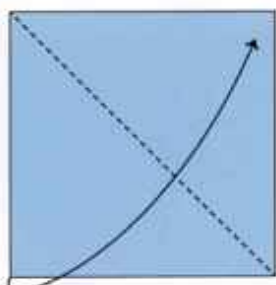

11

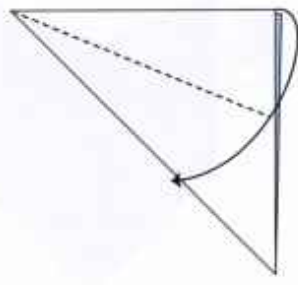

12

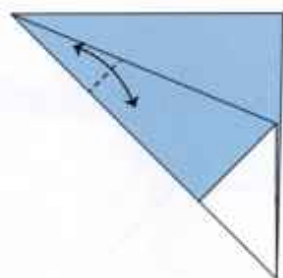

13

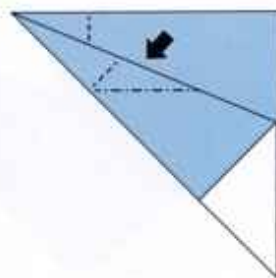

14

12-14

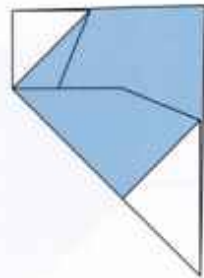

15

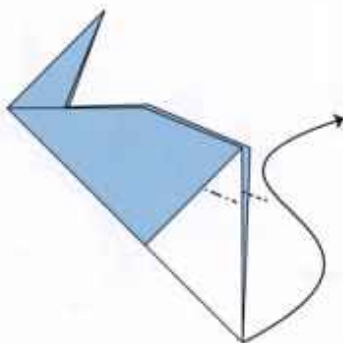

16

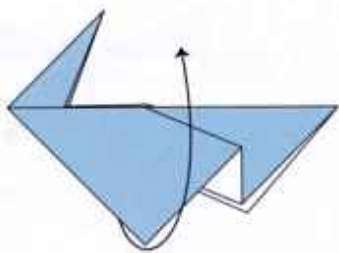

17

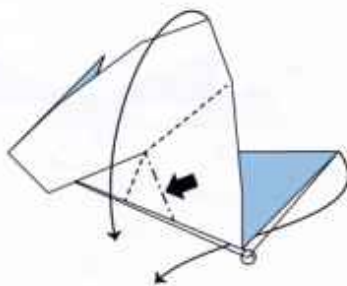

18

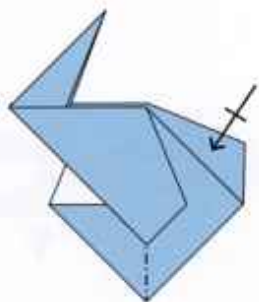

19

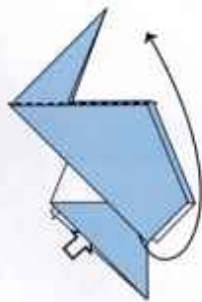

20

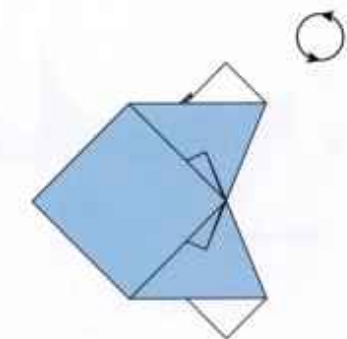

21

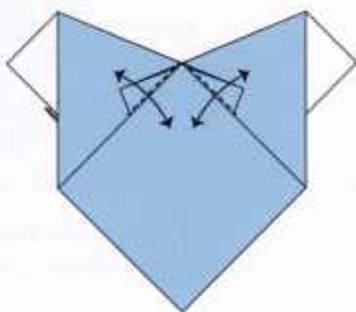

22

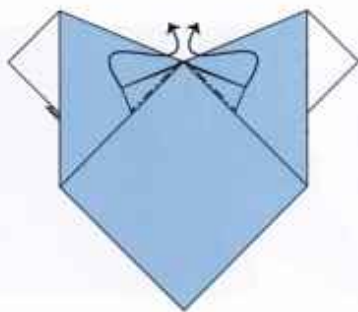

23

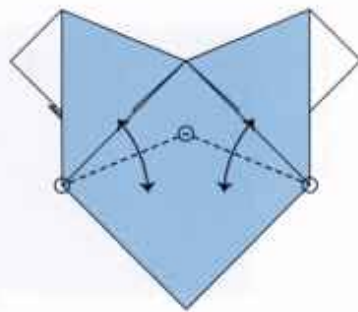

24

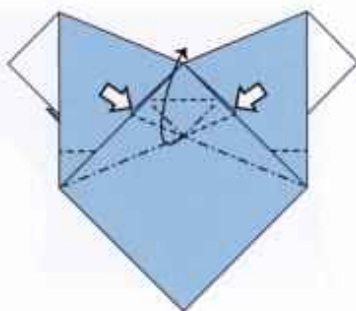

25

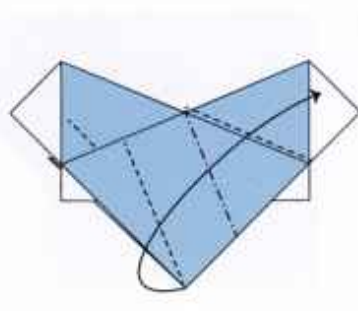

26

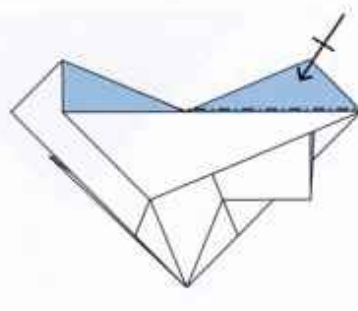

27

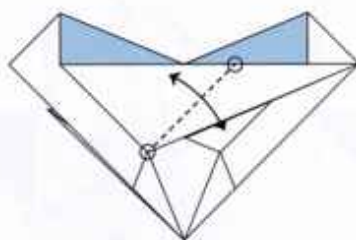

28

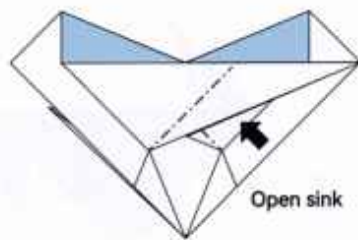

29

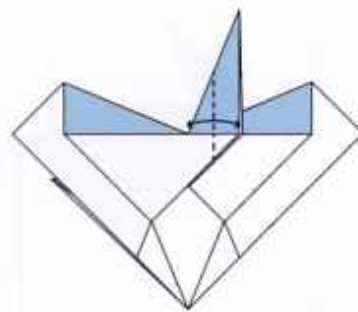

30

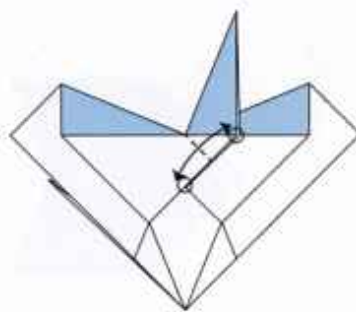

31

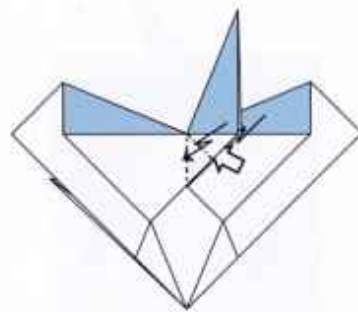

32

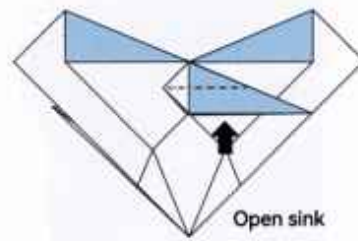

33



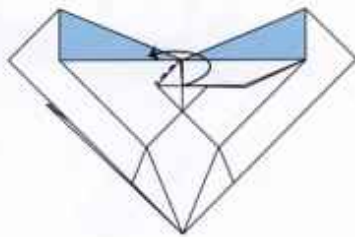

34

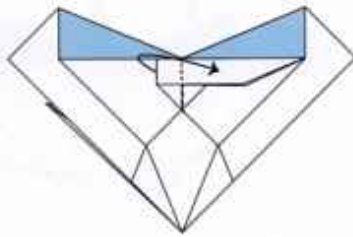

35

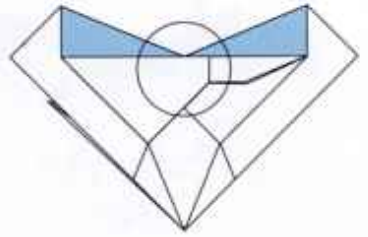

36

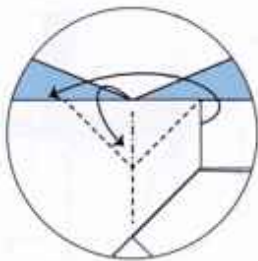

37

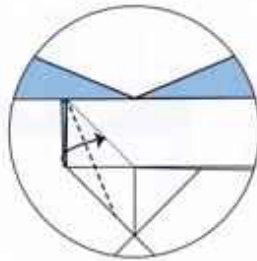

38

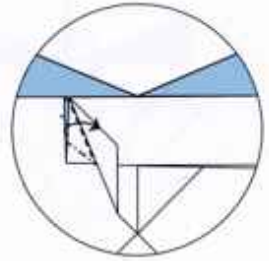

39



40

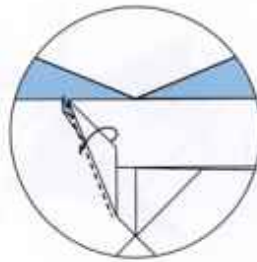

41

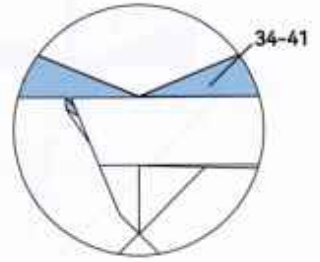

42

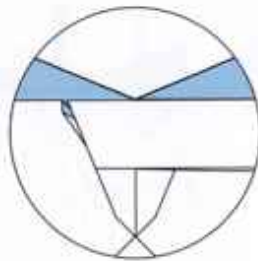

43

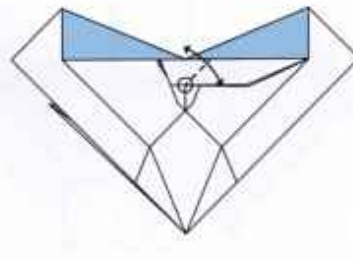

44

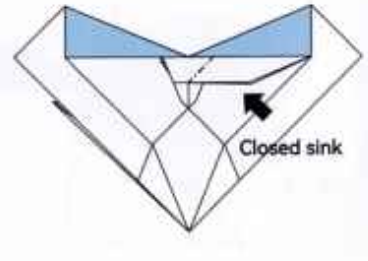

45

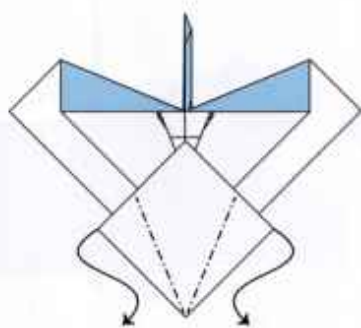

58

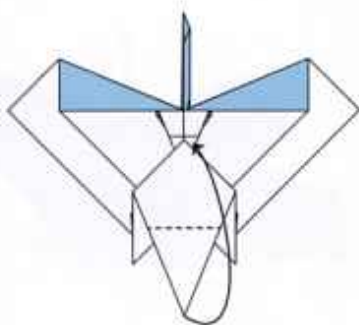

59

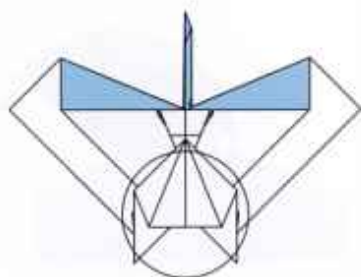

60

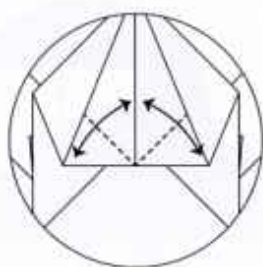

61

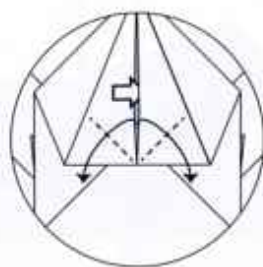

62

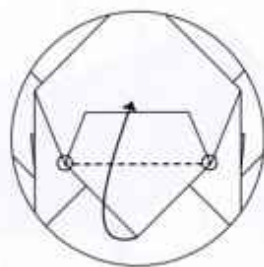

63

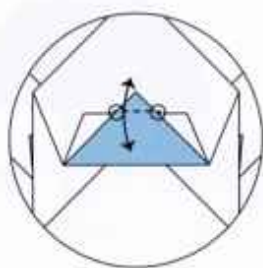

64 Back to 63

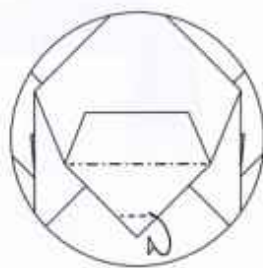

65

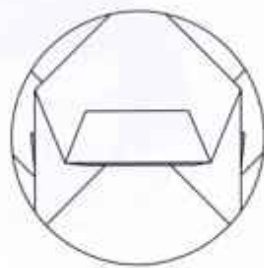

66

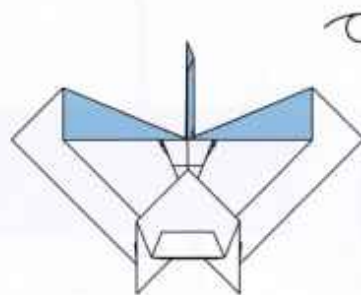

67

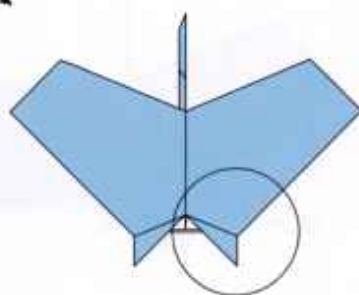

68

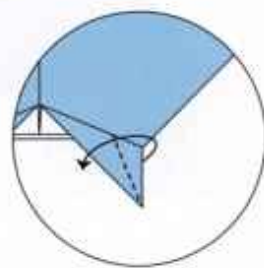

69

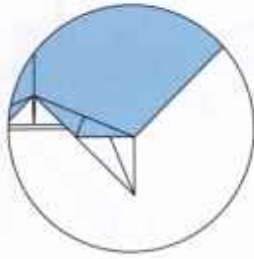

70

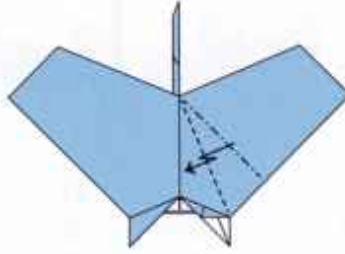

71

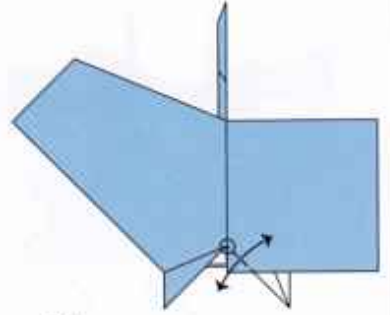

72

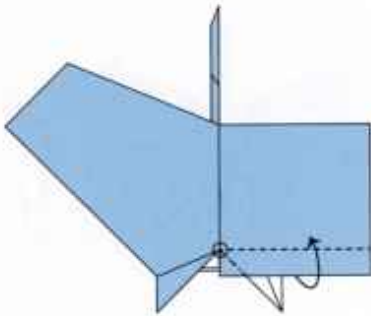

73

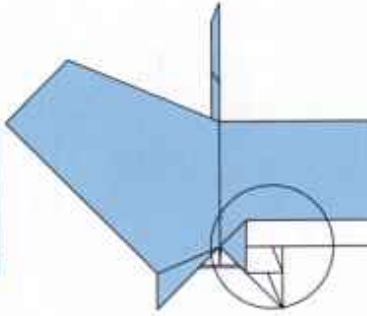

74

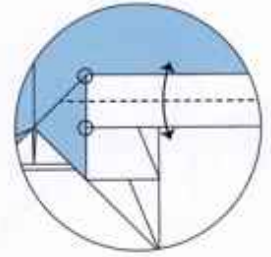

75

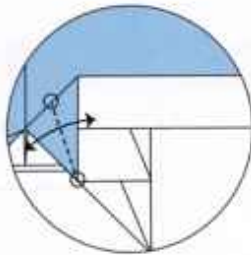

76

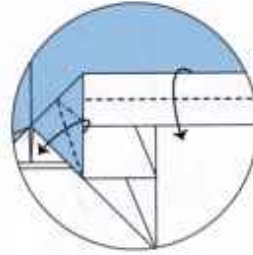

77

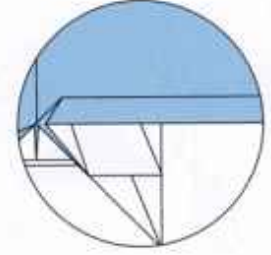

78 Closed sink

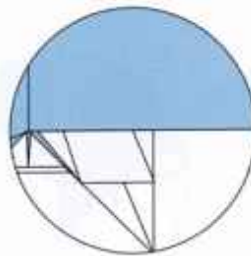

79

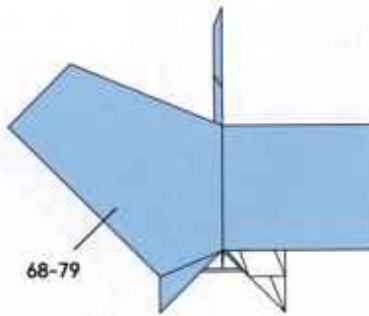

68-79

80

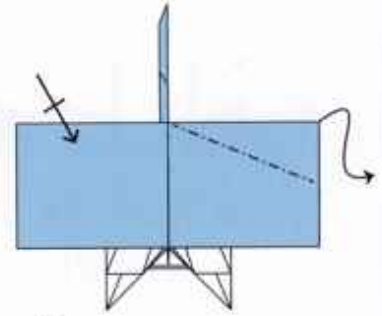

81

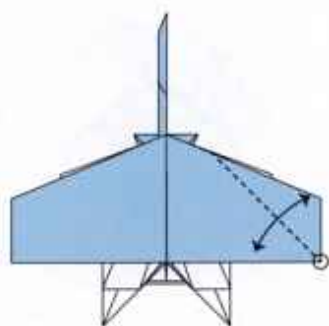

82

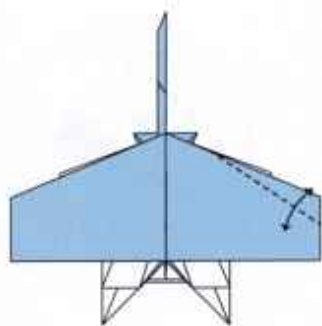

83



84

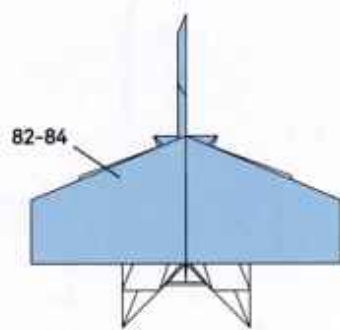

85

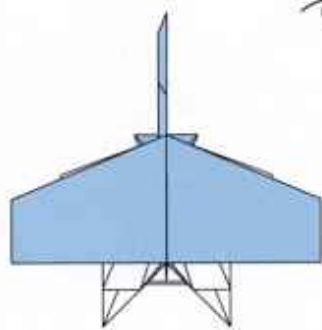

86

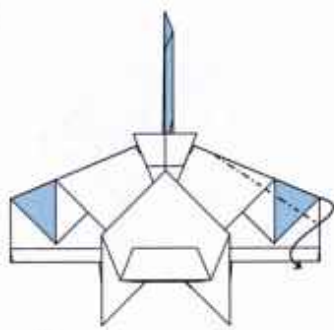

87

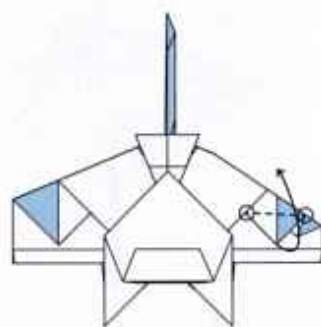

88

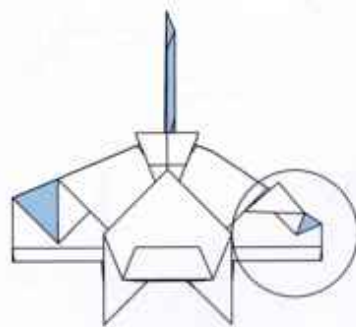

89

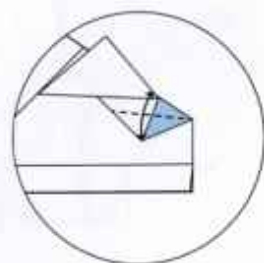

90

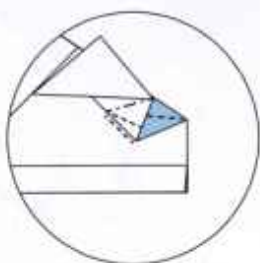

91

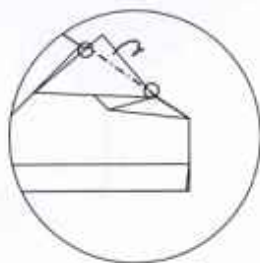

92

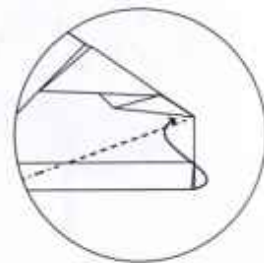

93

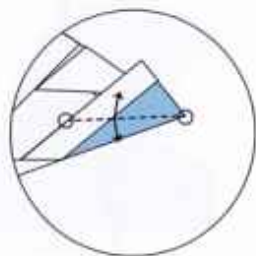

94

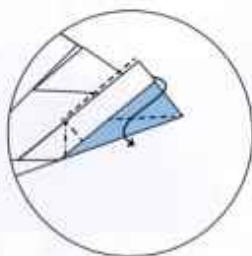

95

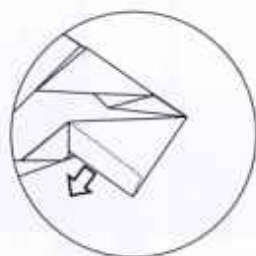

96

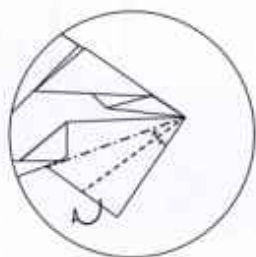

97

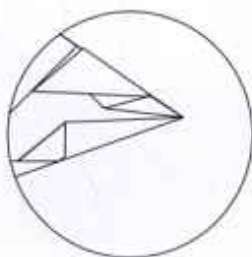

98

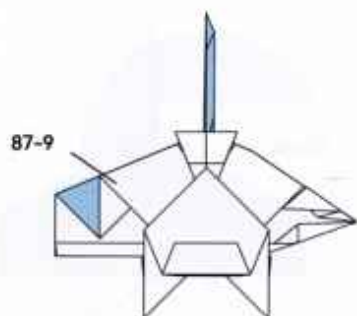

99

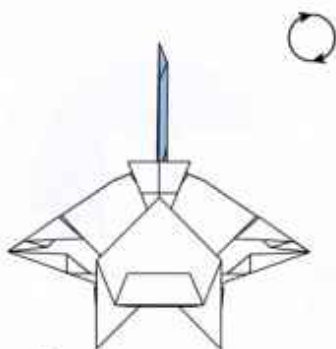

100

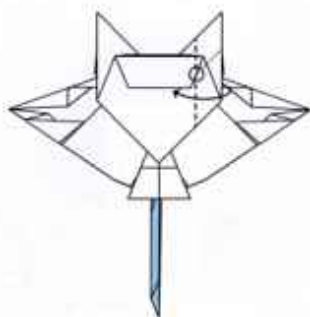

101

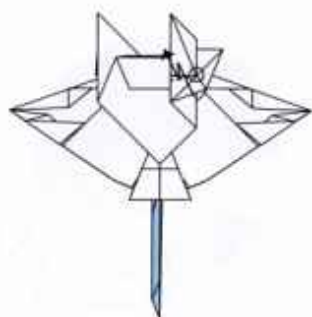

102

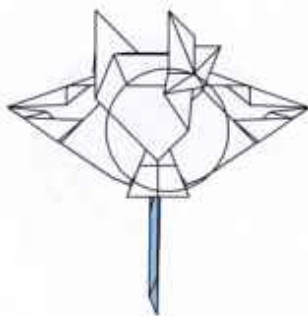

103

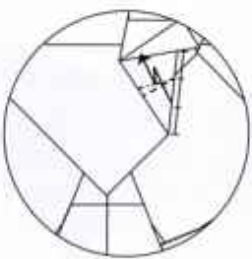

104

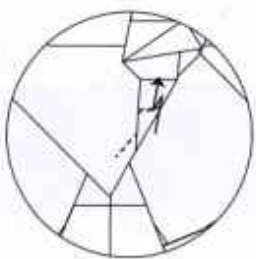

105

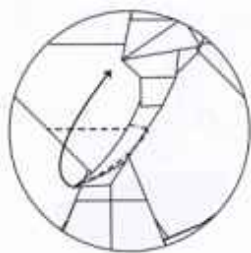

106

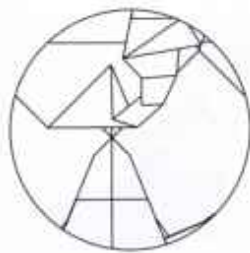

107

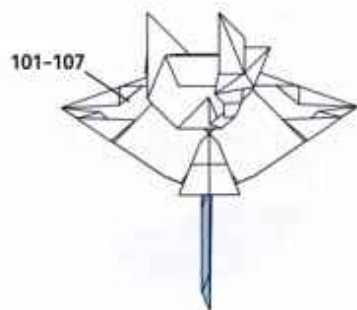

108

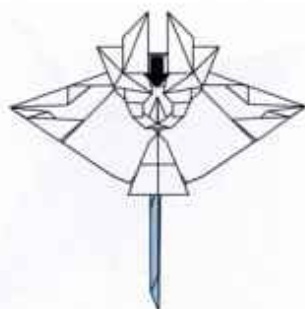

109



110

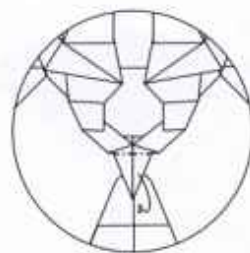

111

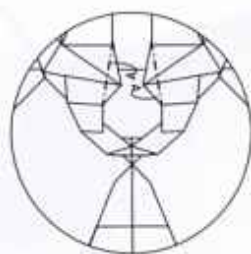

112

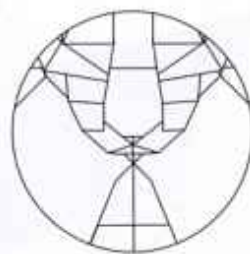

113

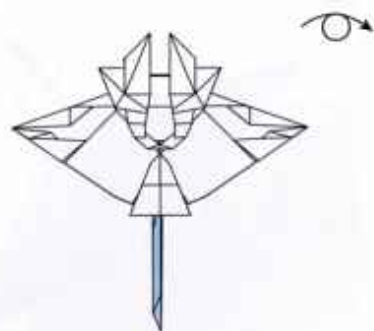

114

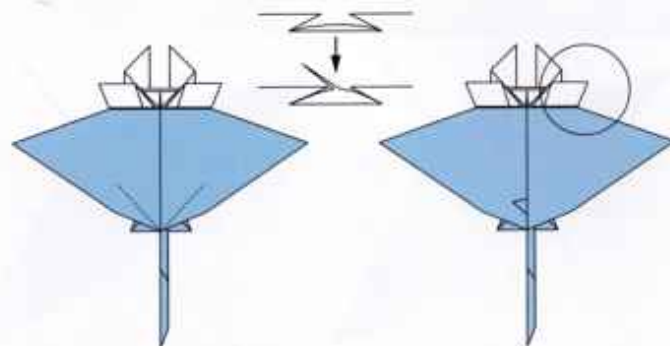

115

116

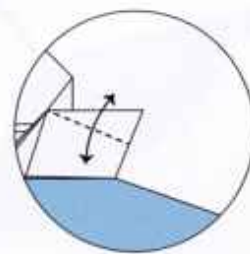

117



118



119

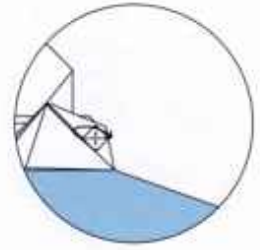

120

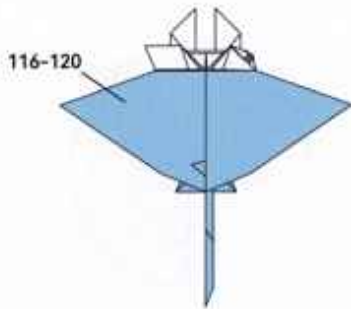

121

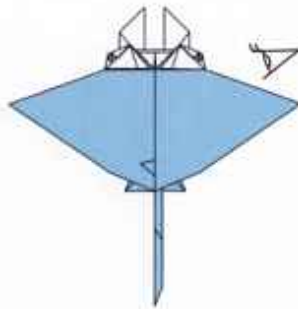

122

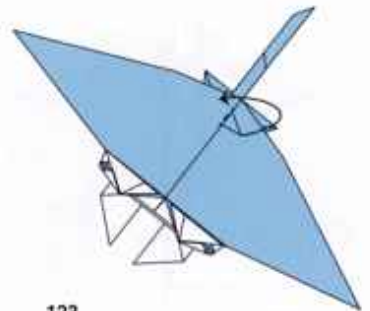

123

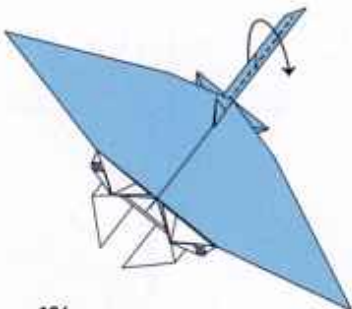

124

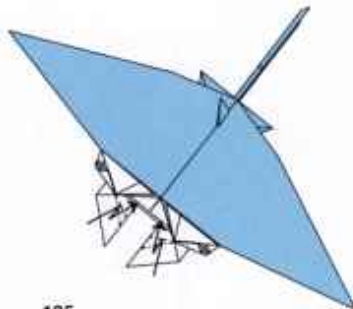

125



126

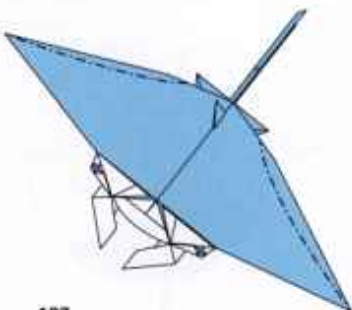

127



128



129 完成 Complete

# 妖娆龙 Enchanting Loong

设计：李清泉  
Design: LiQingquan

推荐用纸/Paper size:  
35cm 生态纸biotope

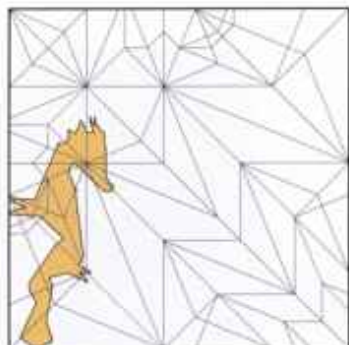

01

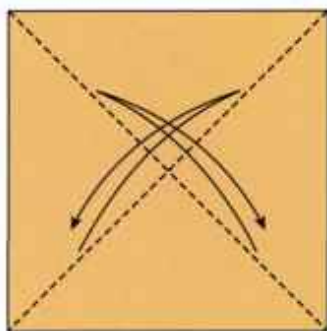

02

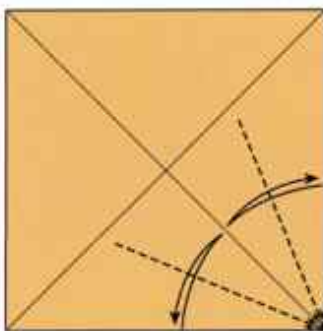

03

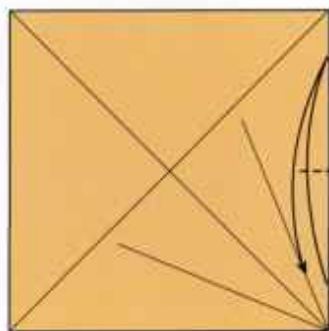

04

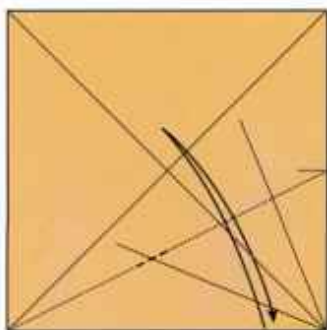

05

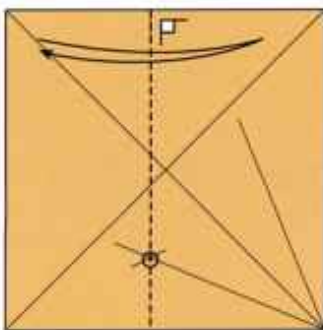

06

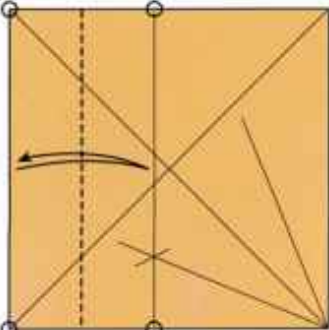

07

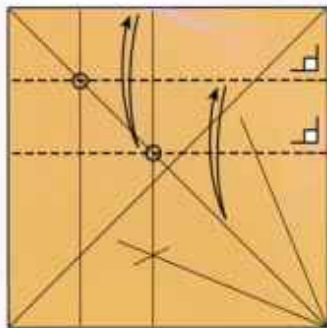

08

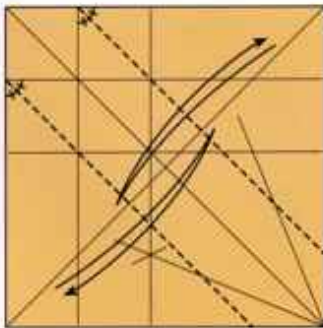

09

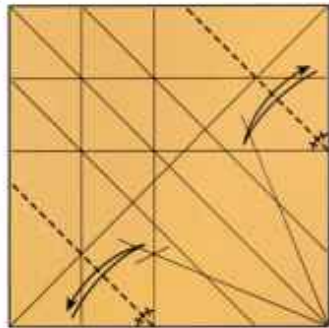



10

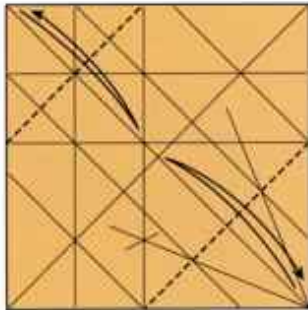

11

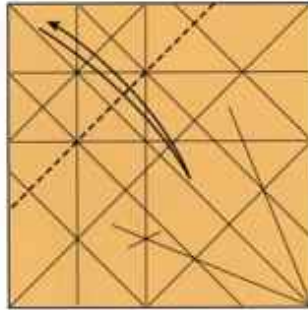

12

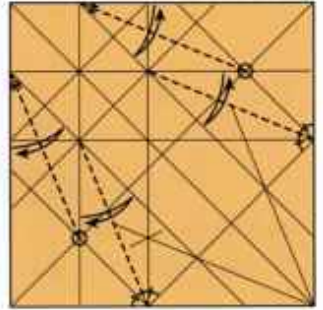

13

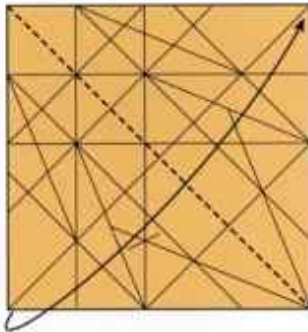

14

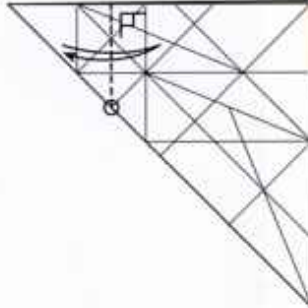

15

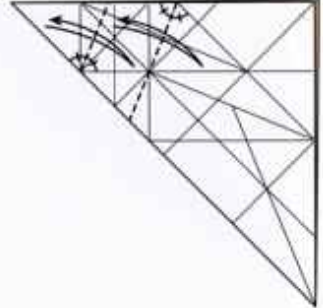

16

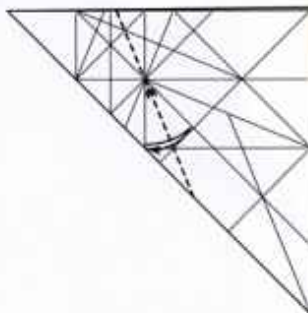

17

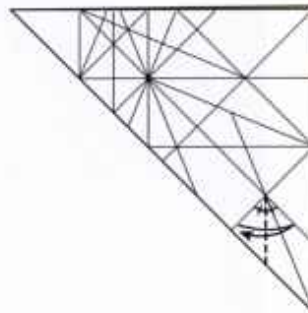

18

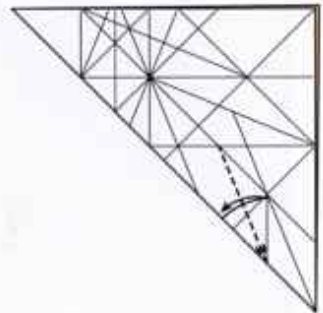

19

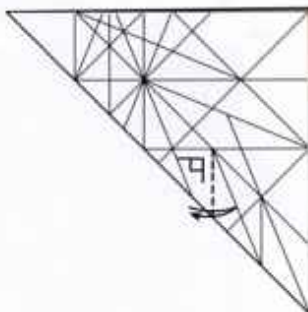

20

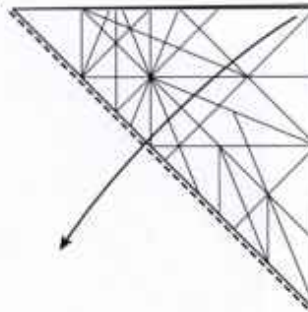

21

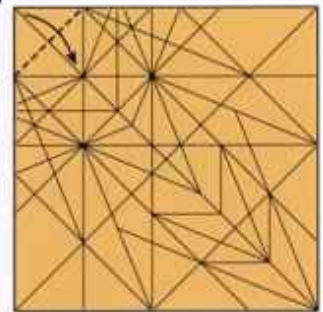

22

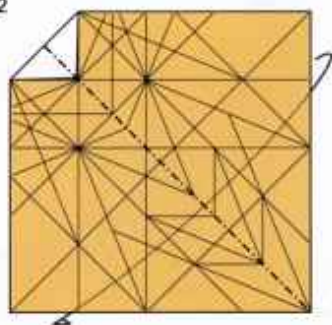

23

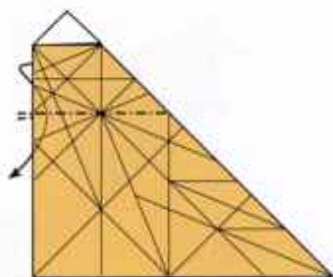

24

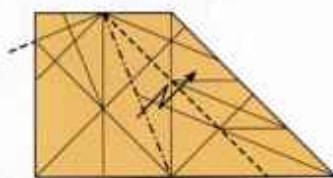

25

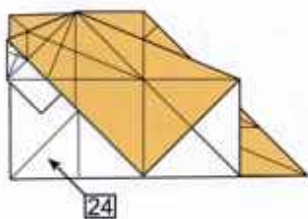

26

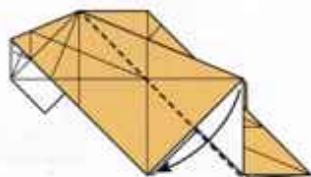

27

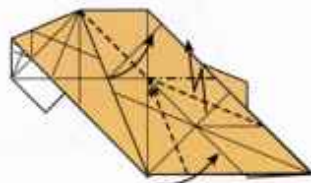

28

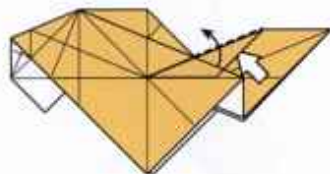

29

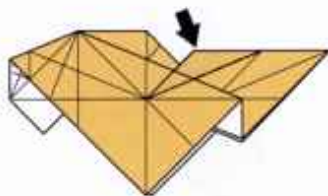

30

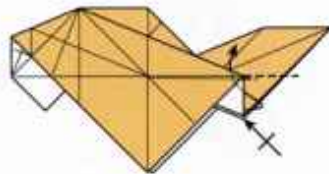

Closed sink

31

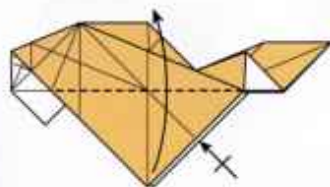

32

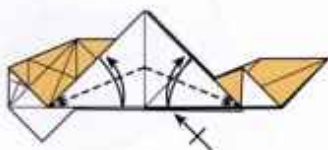

33

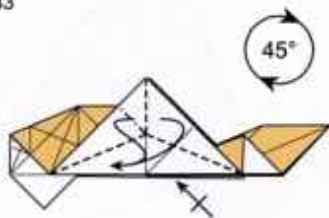

34

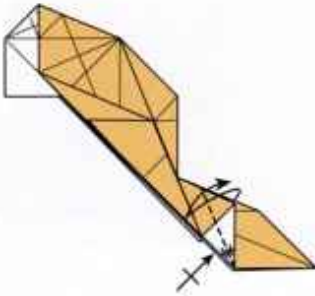

35

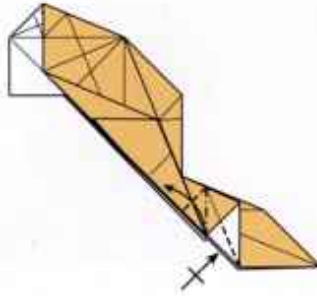

36

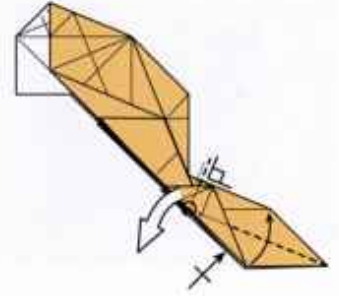

37

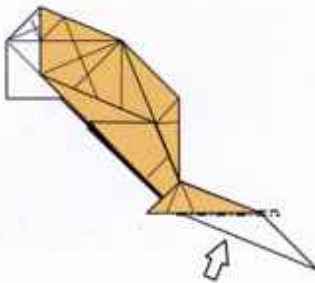

Open sink

38

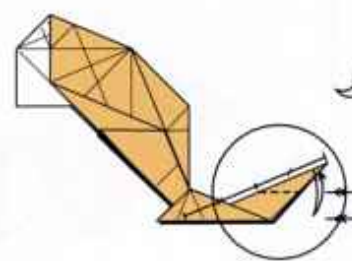

39

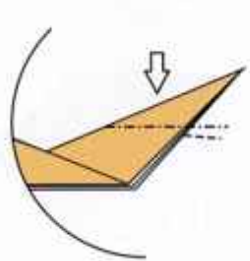

Open sink

40

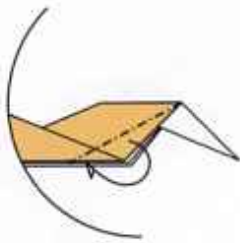

41

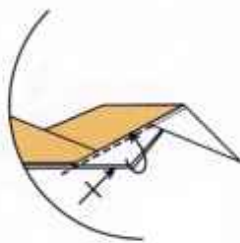

42

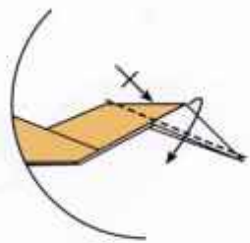

43

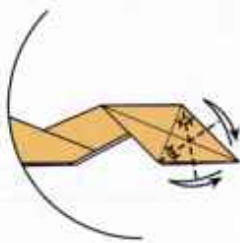

44

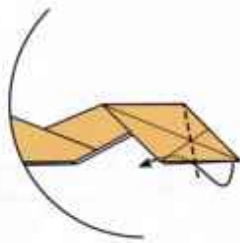

45

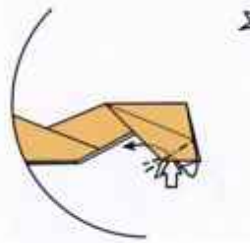

46

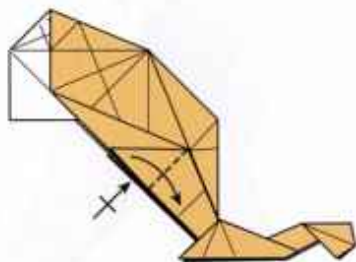

47

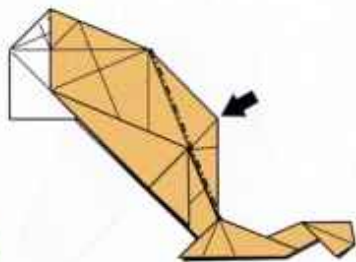

48

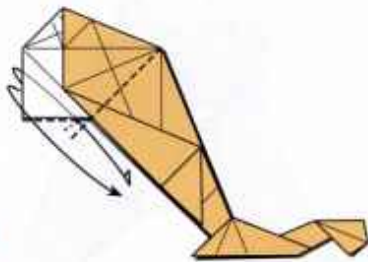

Open sink

49

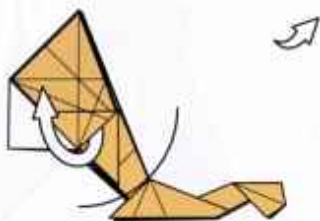

50

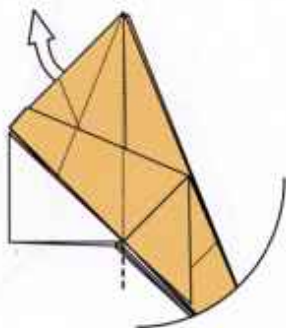

51

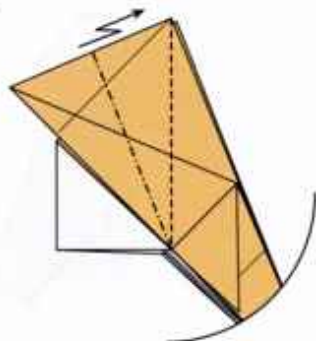

52

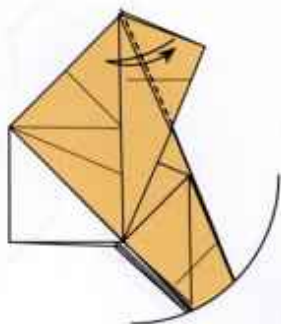

53

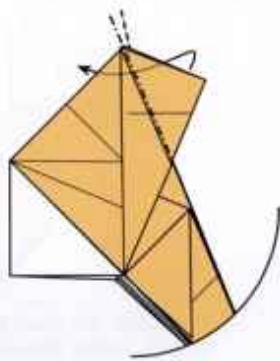

54

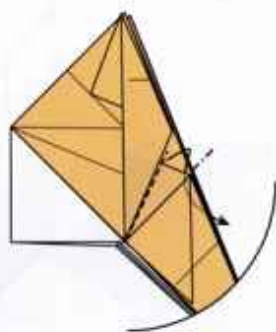

55

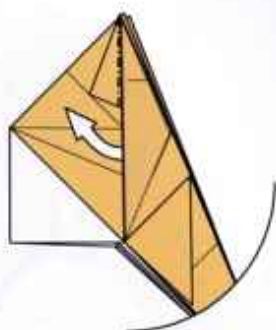

56

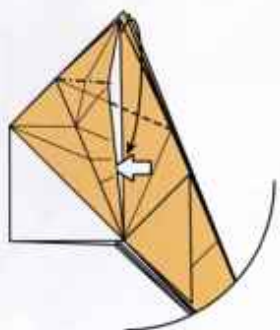

57

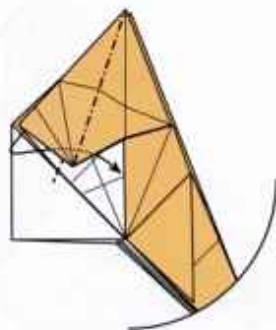

70

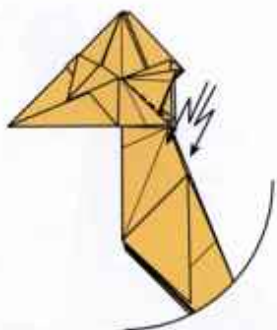

71

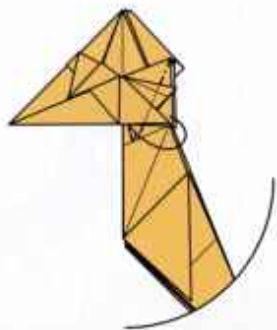

72

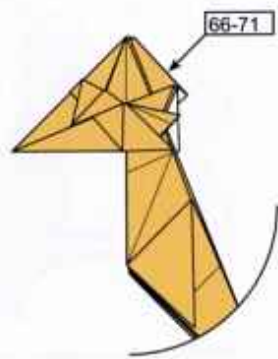

73

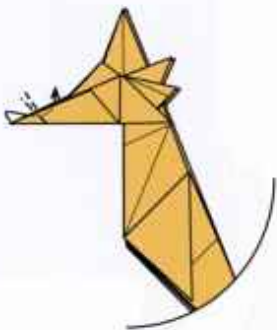

74

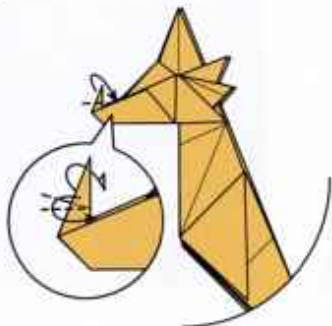

75

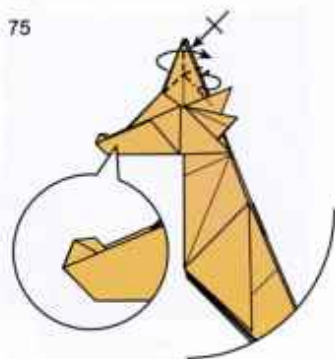

76

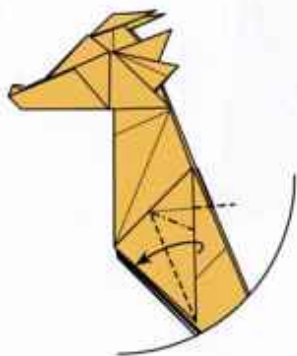

77

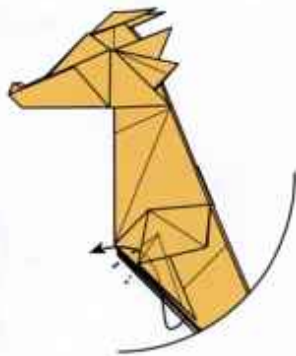

78

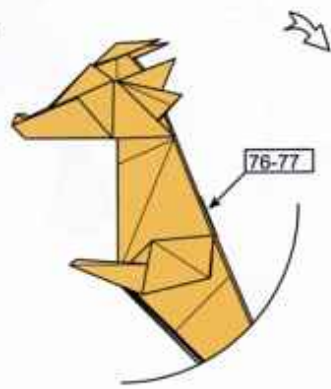

79

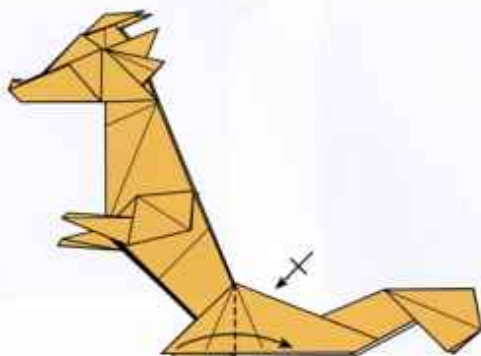

80

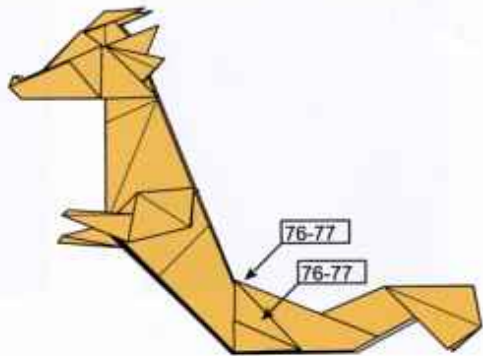

81

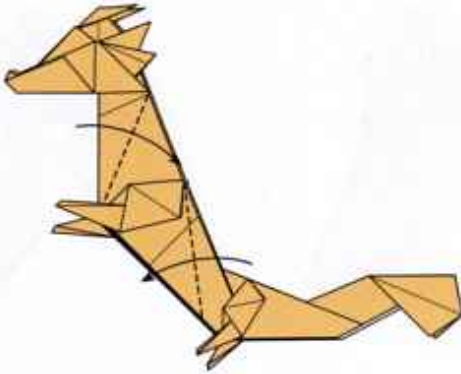

82

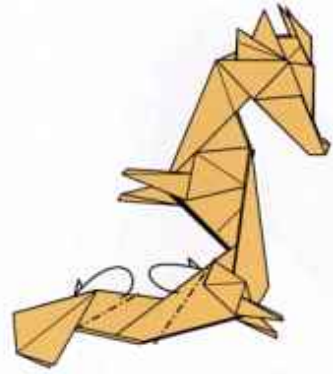

83

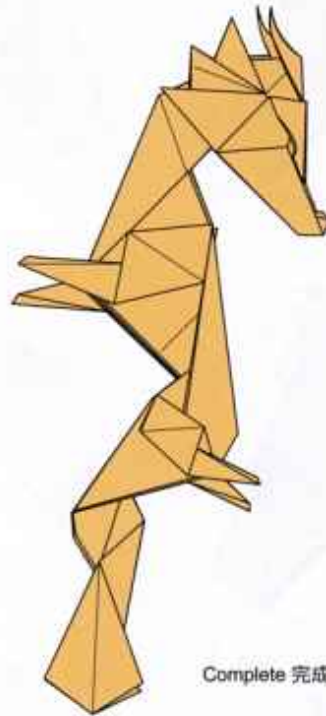
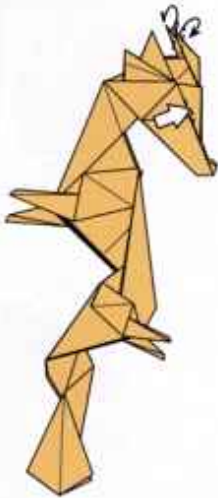

Complete 完成

# 龙

Loong

设计/Designer  
syn/李嘉辉

制图/Diagrams  
咕咕菜

03/2024

纸张大小/Paper Size  
40×40 cm

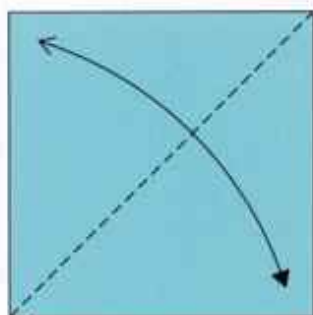
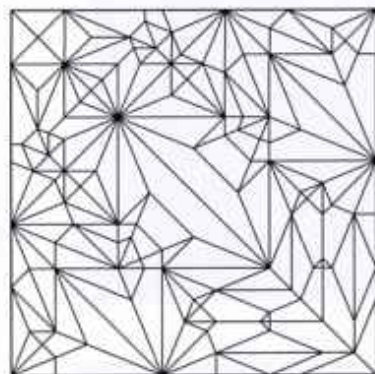
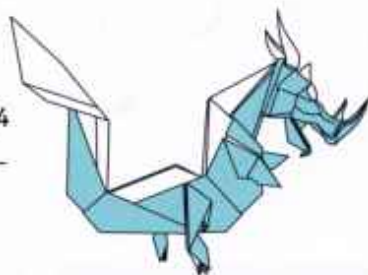

01.

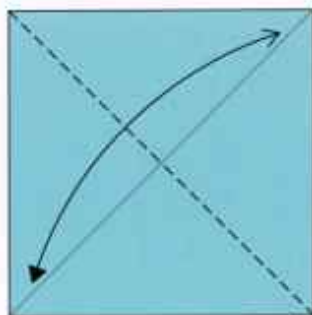

02.

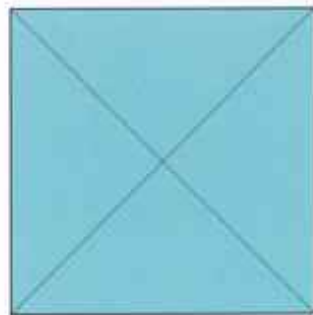

03.

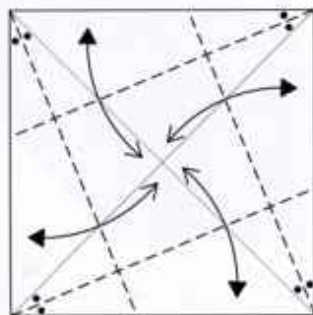

04.

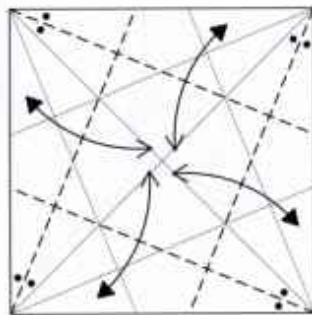

05.

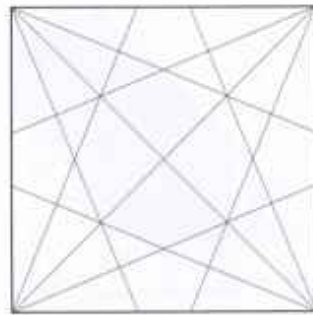

06.

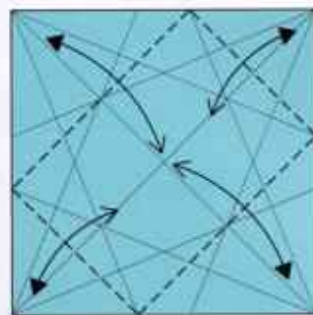

07.



08.

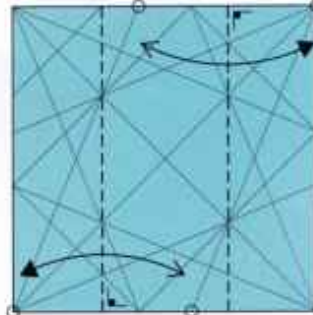

09.

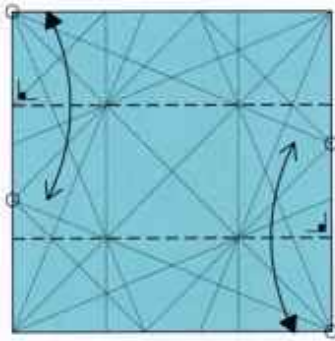

10.

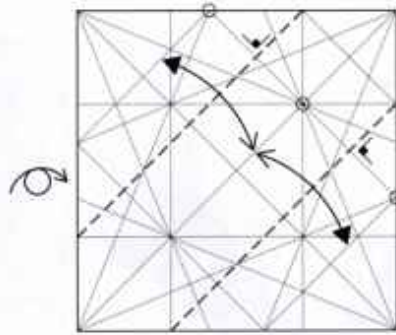

11.

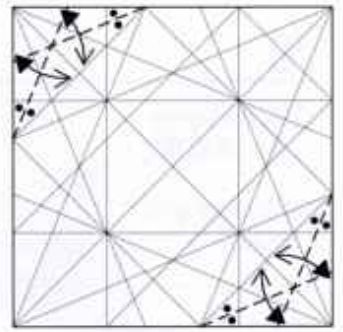

12.

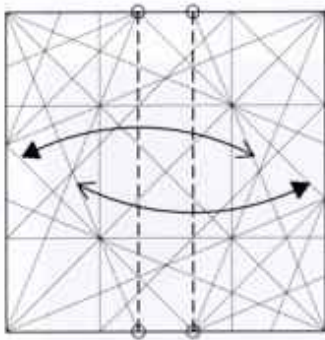

13.

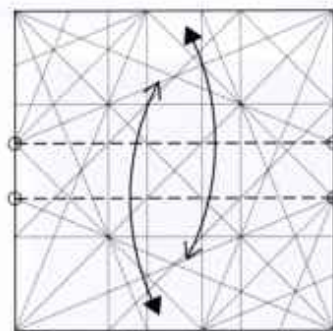

14.

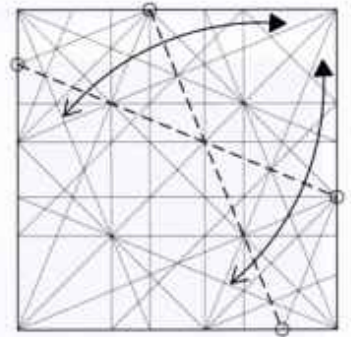

15.

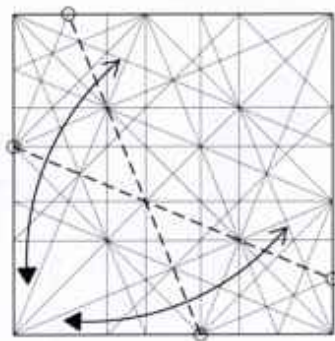

16.

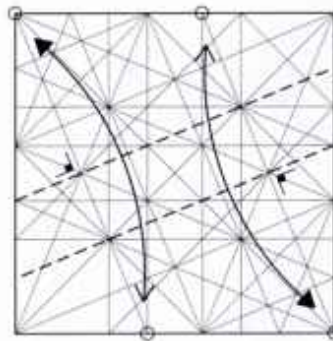

17.

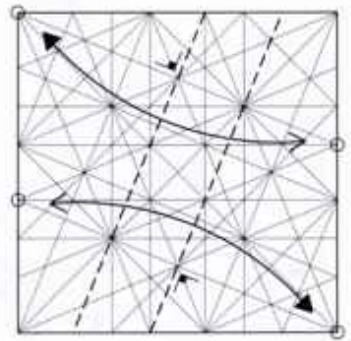

18.

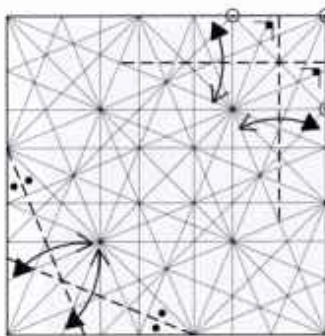

19.

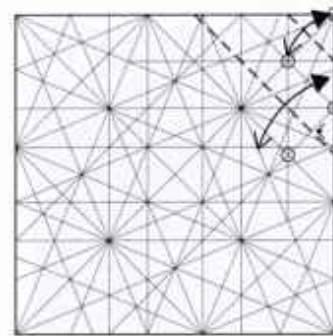

20.

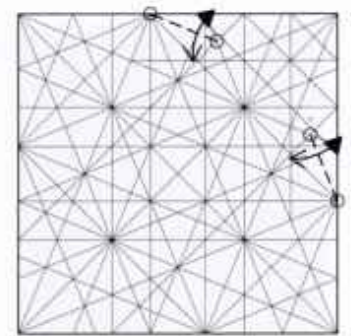

21.



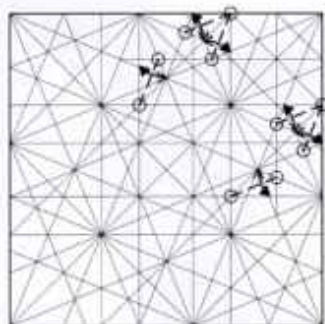

22.

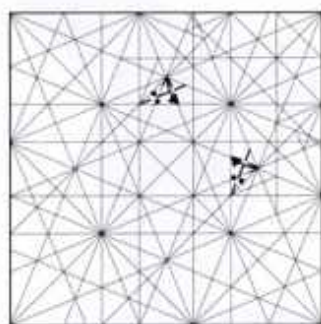

23.

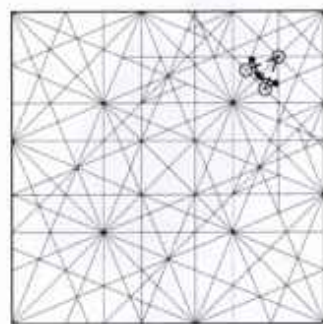

24.

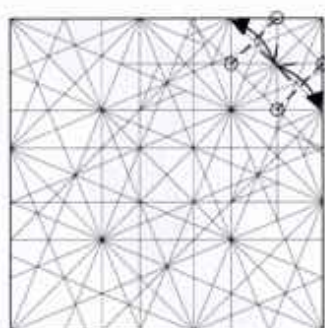

25.

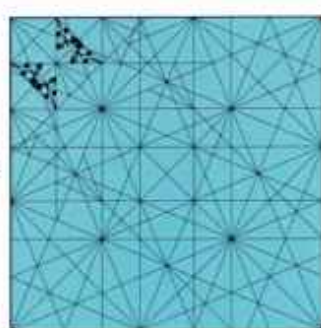

26.

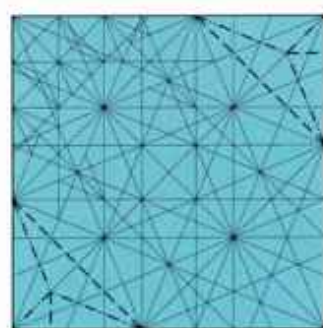

27.



28.

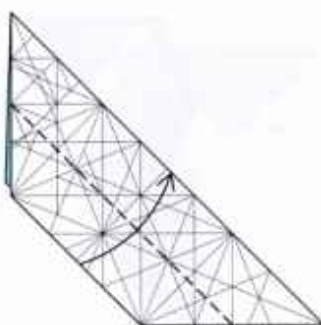

29.

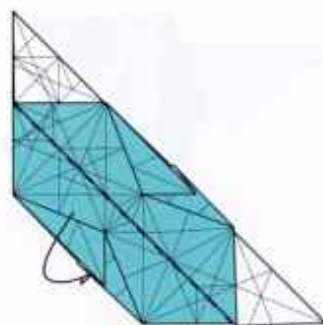

30.

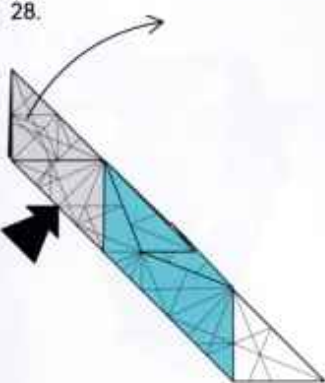

31. 开放沉折

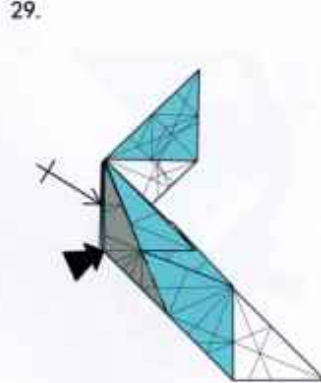

32. 开放沉折, 后面重复操作

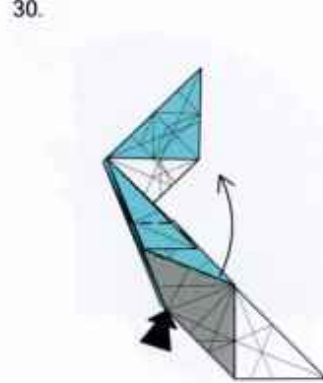

33. 延展沉折

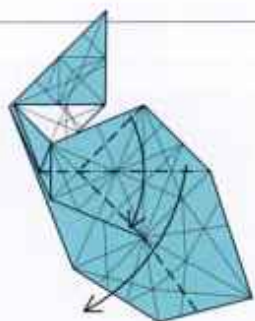

34.

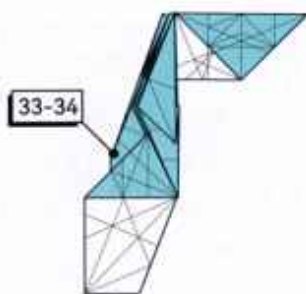

35. 后面重复33-34步，然后压平

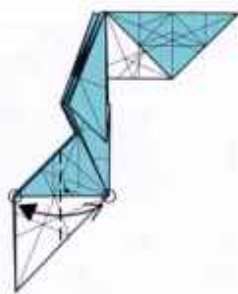

36.

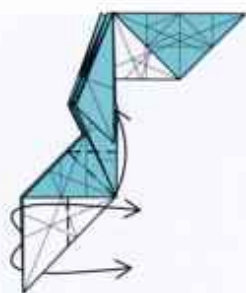

37.



38. 开放沉折，后面重复操作

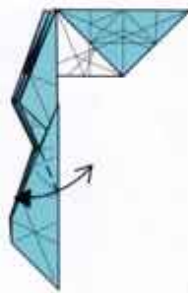

39.

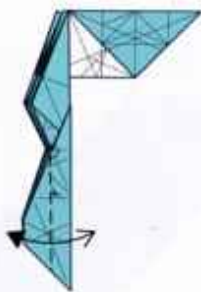

40.

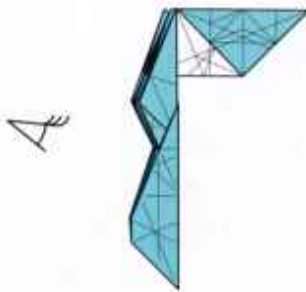

41. 转换视角，并打开纸层

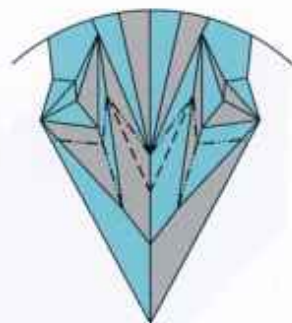

42. 按照峰谷聚合

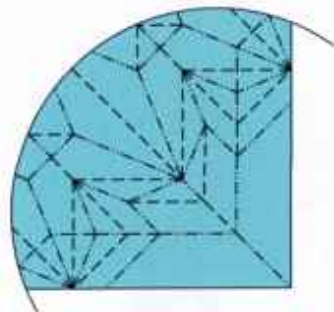

43. 折痕图

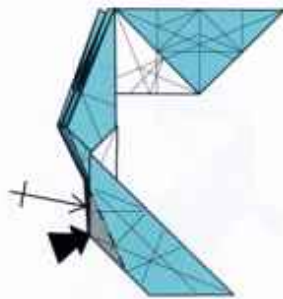

44. 开放沉折，后面重复操作



45.

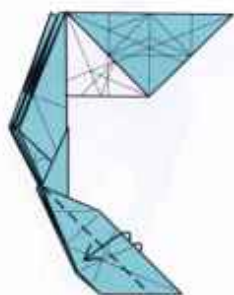

46.

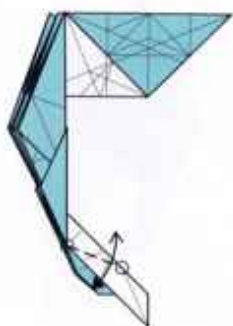

47.



48. 开放沉折



49.



50. 纸层折到里面

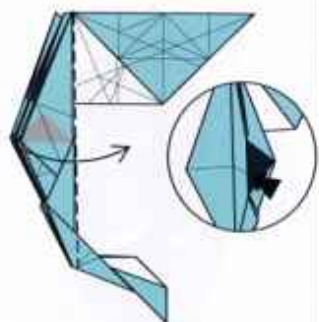

51. 打开纸层, 延展沉折

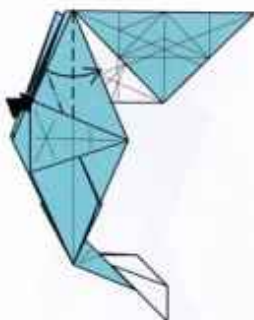

52. 延展沉折

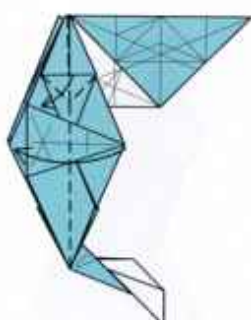

53.

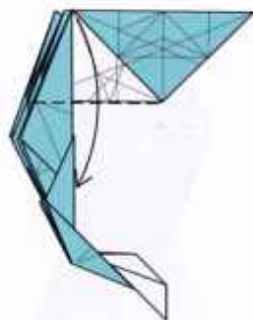

54.

50-54



55. 重复50-54步

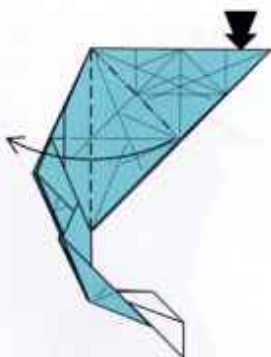

56.

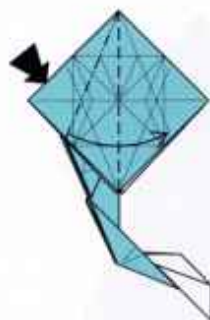

57.



58.

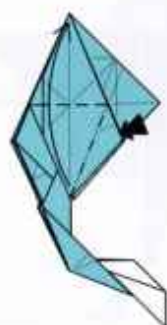

59.



60. 延展沉折



61.

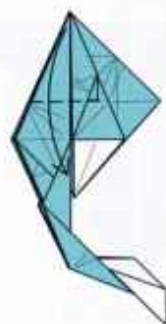

62.



63. 按图示发力，将纸层朝箭头方向挤出



64. 闭合沉折到后面的纸层

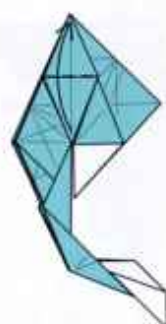

65.



66. 此时内部纸层如图所示

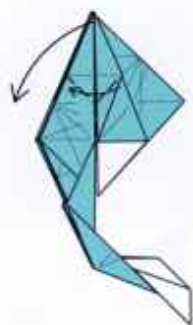

67.

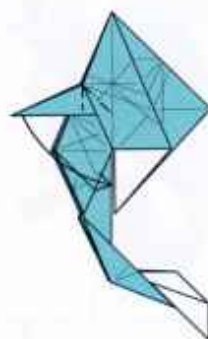

68. 双向段折，前面只有一层纸层



69.

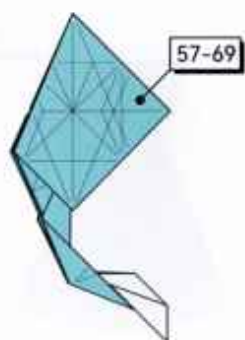

70. 重复57-9步

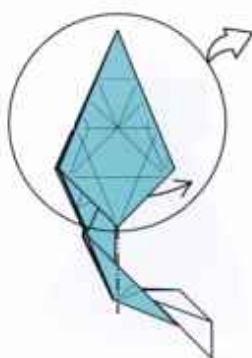

71. 将背后纸层均匀折过来

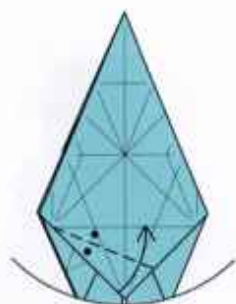

72.

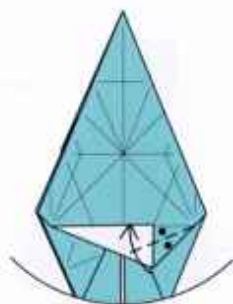

73.

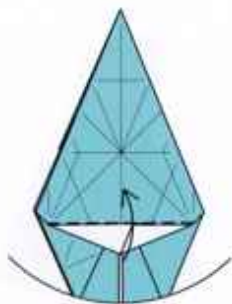

74.

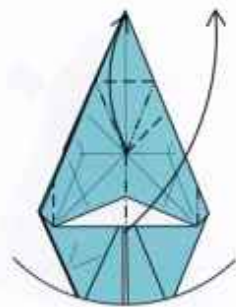

75.

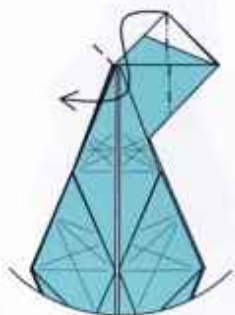

76.

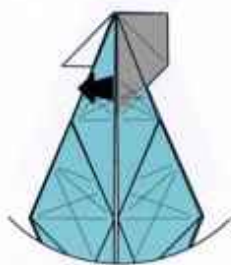

77. 将阴影部分两层纸层其中一层引到另一半

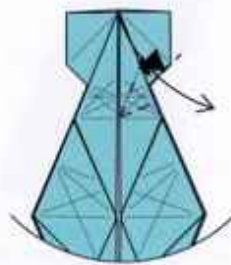

78.



79.

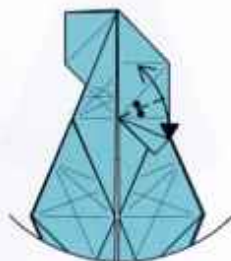

80.

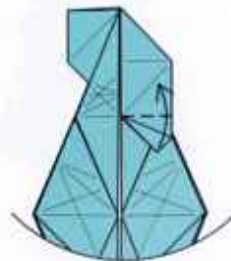

81.

78-93

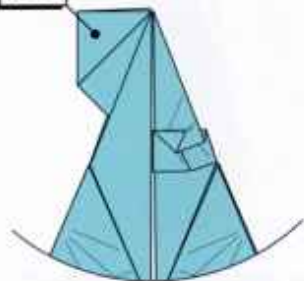

94.

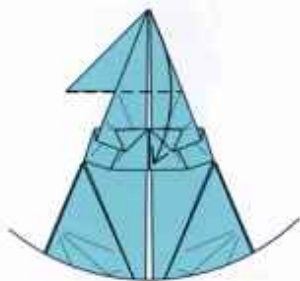

95.

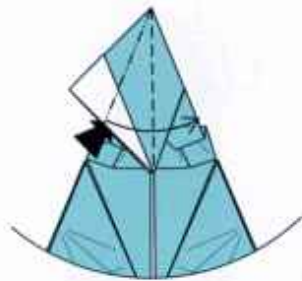

96.

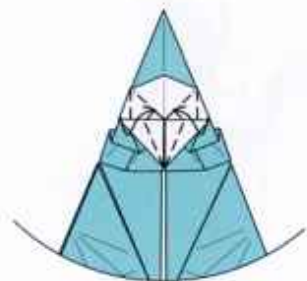

97.

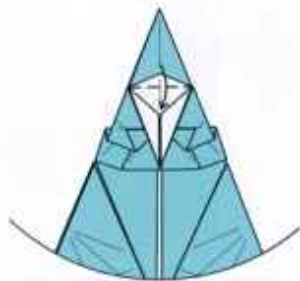

98.

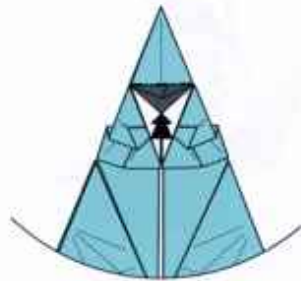

99. 沉折进里面

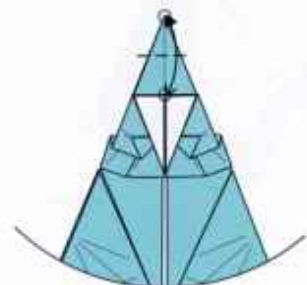

100.

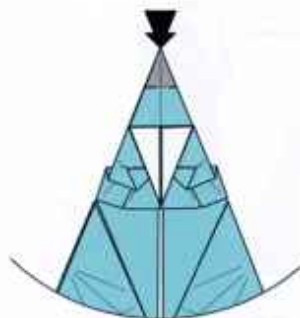

101. 开放沉折

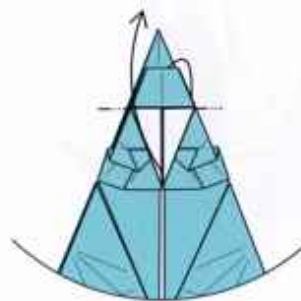

102. 上面的纸层折下去，下面的纸层折上来

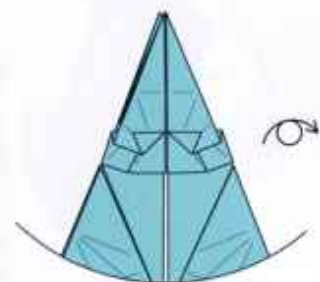

103. 翻到背面

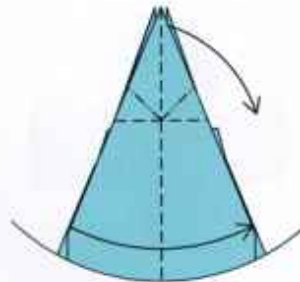

104.

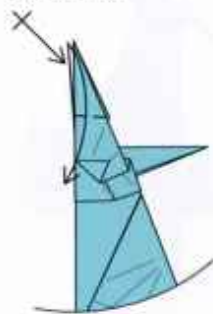

105.

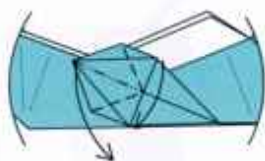

130.

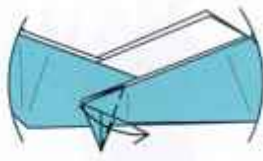

131.

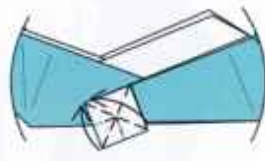

132.

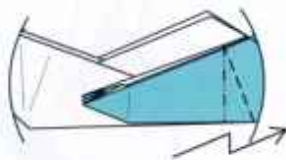

133.

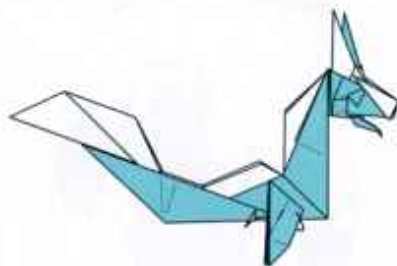

134.

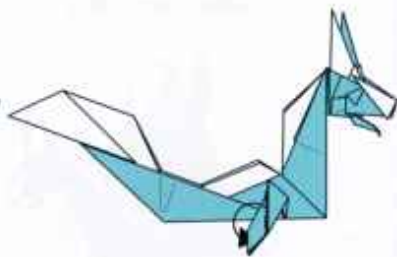

135.

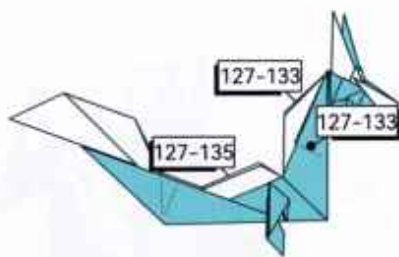

136.

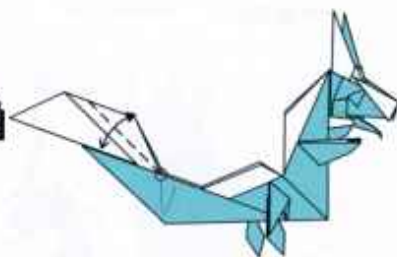

137.

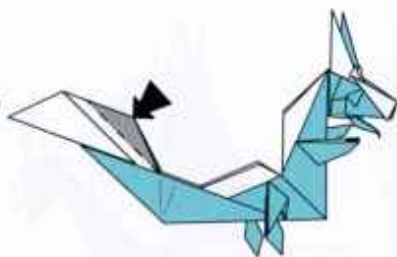

138. 开放沉折

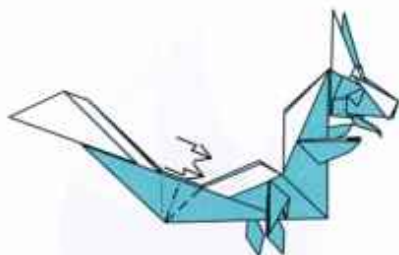

139.

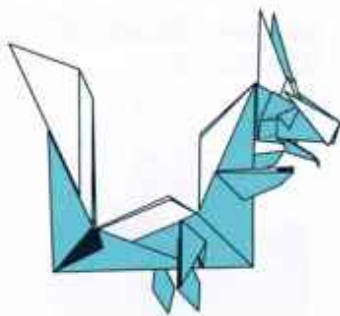

140. 如前面步骤一样闭合沉折

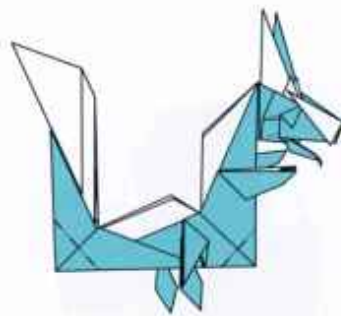

141. 将纸层分别折进里面

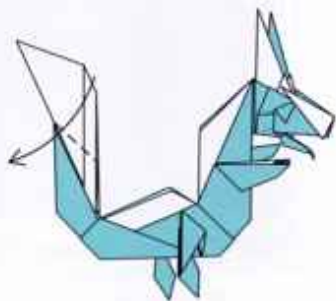

142.

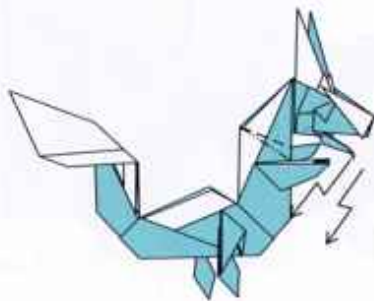

143.

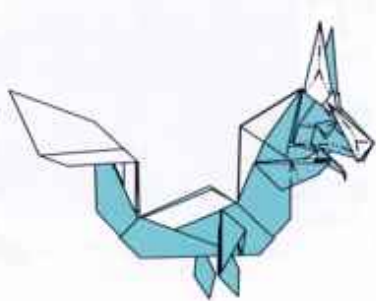

144. 最后稍微捏出造型

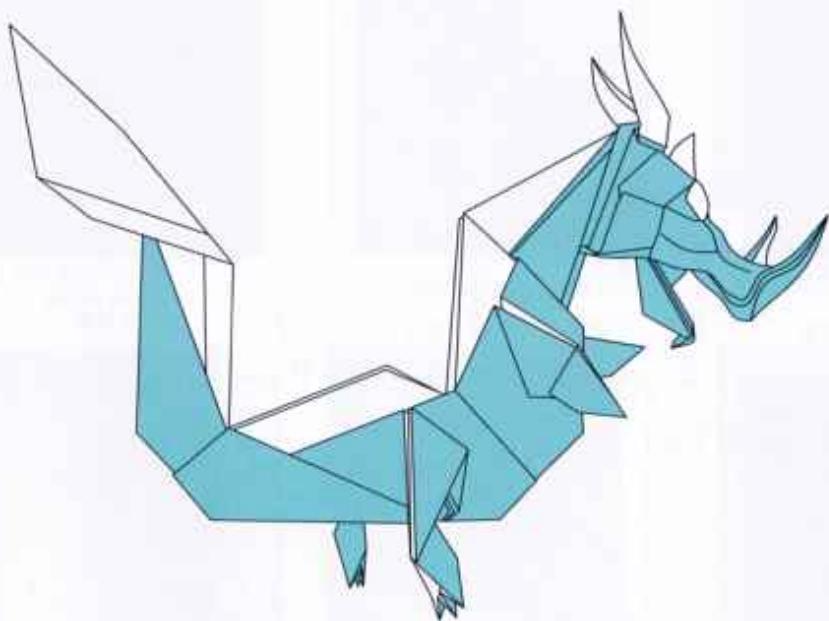

145. 完成!



# 中国龙

Loong

设计 / Designed: 涂开明  
 图示 / Diagram: 银铃

推荐用纸 / Paper :  
 - Kami 60x60 cm

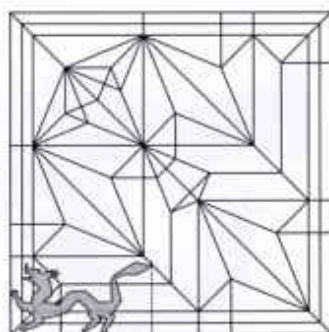
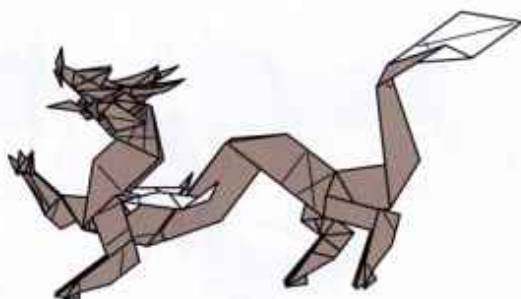

0.44

- 1**

Fold along the diagonals and unfold.  
沿对角线留下折痕
- 2**

Fold along the angle bisectors and unfold.  
沿角平分线留下折痕
- 3**

Fold then unfold.  
留下折痕
- 4**

Fold then unfold.  
留下折痕
- 5**

Fold along the angle bisectors and unfold.  
沿角平分线留下折痕
- 6**

Fold along the angle bisectors and unfold.  
沿角平分线留下折痕
- 7**

Crease according to the marked points.  
依参考点留下折痕
- 8**

Turn over.  
翻面
- 9**

Fold then unfold.  
留下折痕

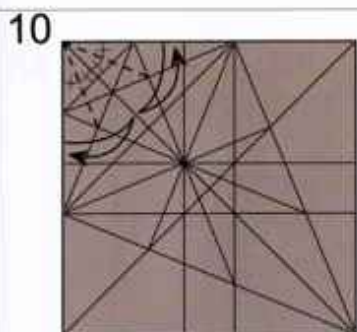

Fold along the angle bisectors and unfold.  
沿角平分线留下折痕

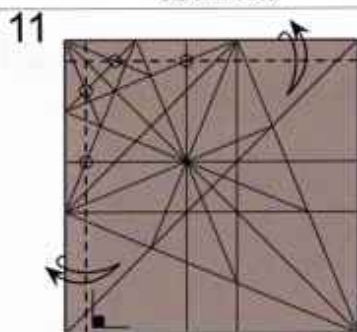

Crease according to the marked points.  
依参考点留下折痕

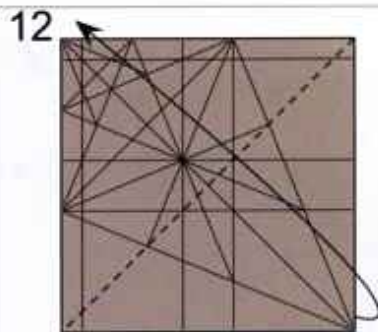

Valley-fold along the diagonal.  
沿对角线谷折

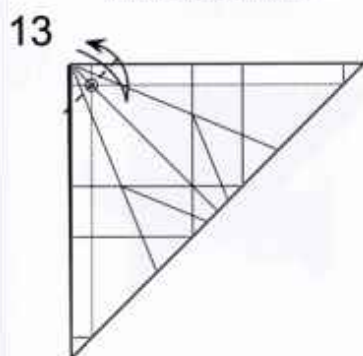

Crease according to the marked point.  
依参考点留下折痕

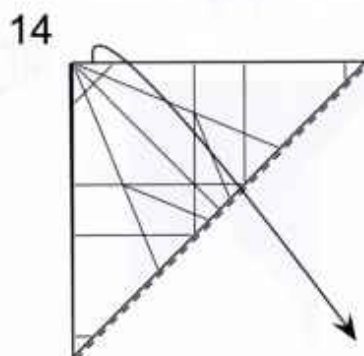

Unfold.  
打开

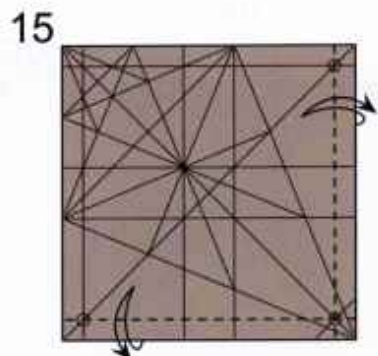

Crease according to the marked points.  
依参考点留下折痕

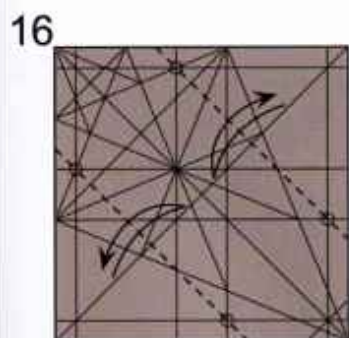

Crease according to the marked points.  
依参考点留下折痕

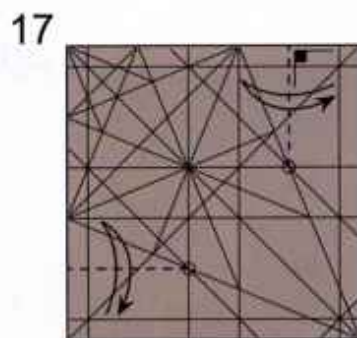

Fold then unfold.  
留下折痕

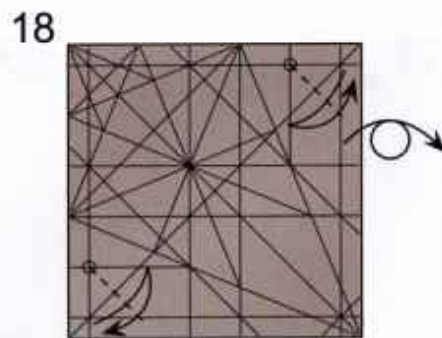

Fold then unfold.  
留下折痕

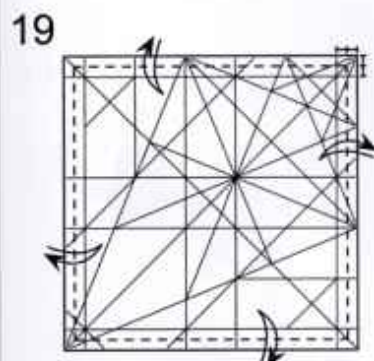

Fold then unfold.  
留下折痕

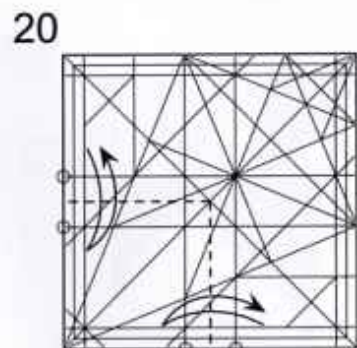

Fold then unfold.  
留下折痕

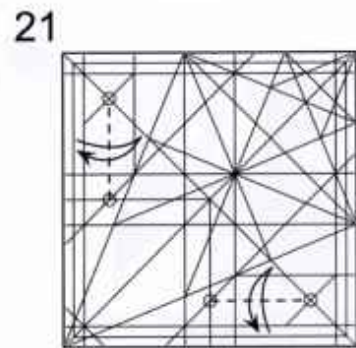

Fold then unfold.  
留下折痕

22

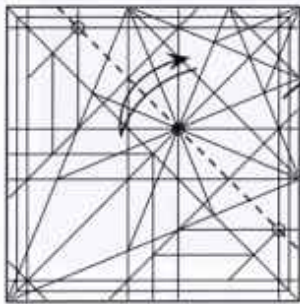

Turn over.  
翻面

23

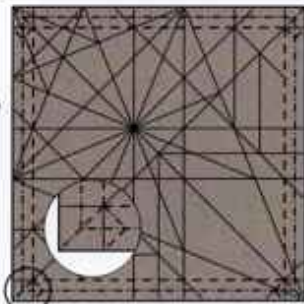

Collapse according to the creases.  
按峰谷聚合

24

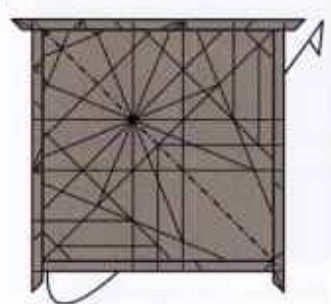

Mountain-fold in half.  
沿峰线对折

25

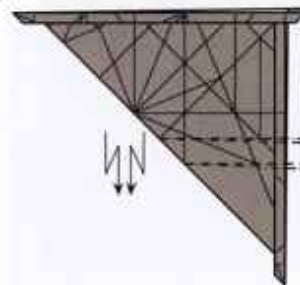

Crimp.  
双向段折

26

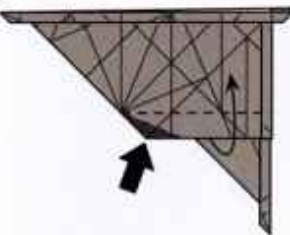

Spread sink.  
延展沉折

27

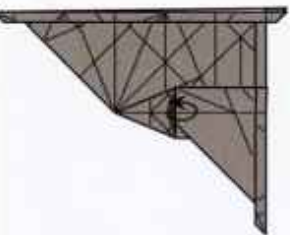

Pull out the hidden layer.  
引出内部纸层

28

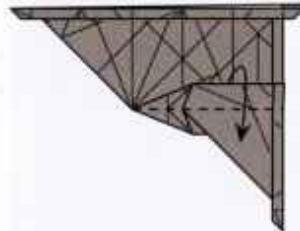

Valley-fold.  
谷折

29

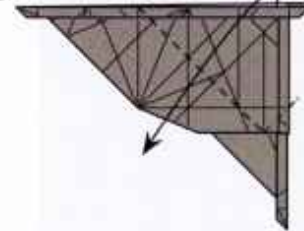

Valley-fold. The model will not stay flat.  
谷折。模型无法压平

30

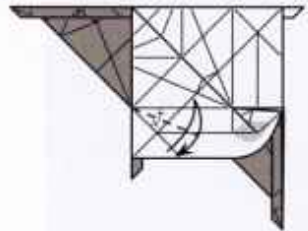

Fold along the angle bisectors  
and unfold.  
沿角平分线留下折痕

31

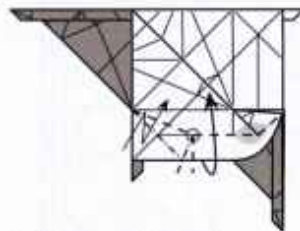

Collapse according to the creases.  
按峰谷聚合

32

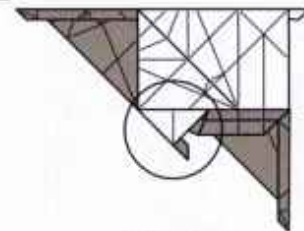

Zoom in.  
局部视图放大

33

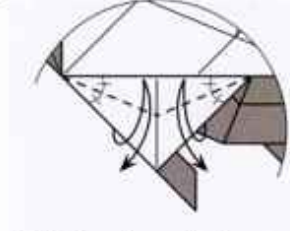

Fold along the angle bisectors  
and unfold.  
沿角平分线留下折痕

46

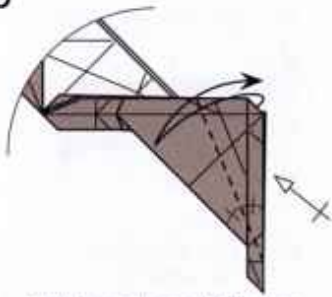

Fold along the angle bisectors  
and unfold. Repeat behind.  
沿角平分线留下折痕，后侧重复

47

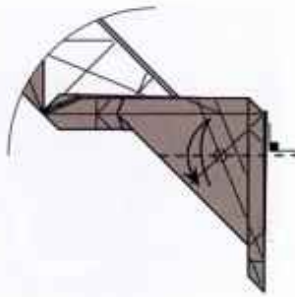

Fold then unfold.  
留下折痕

48

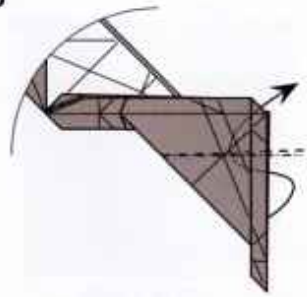

Inside reverse-fold.  
内翻折

49

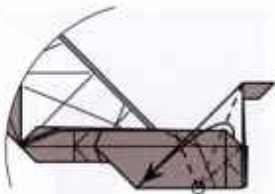

Swivel-fold.  
旋转折

50

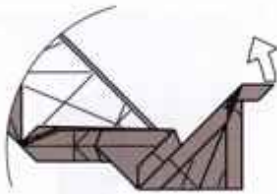

Pull out the hidden layer.  
引出内部纸层

51

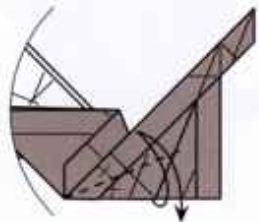

Fold along the angle bisectors  
and unfold.  
沿角平分线留下折痕

52

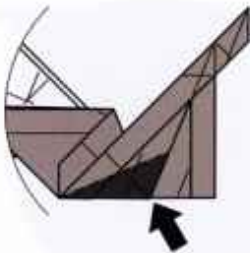

Open sink.  
开放沉折

53

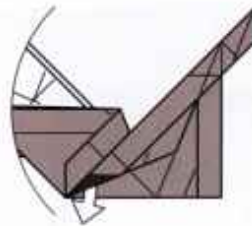

Pull out the hidden layer.  
引出内部纸层

54

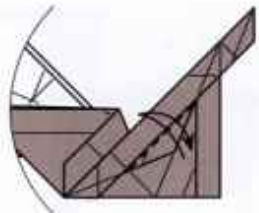

Pre-crease.  
留下折痕

55

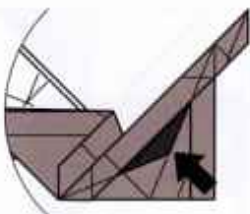

Open sink.  
开放沉折

56

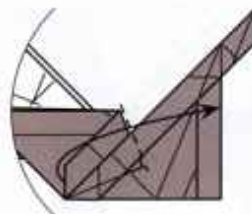

Valley-fold.  
谷折

57

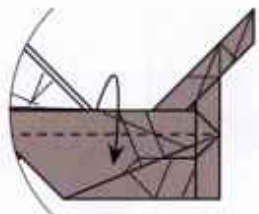

Valley-fold.  
谷折

58

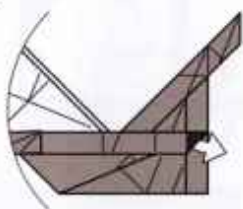

Pull out the hidden layer.  
引出内部纸层

59

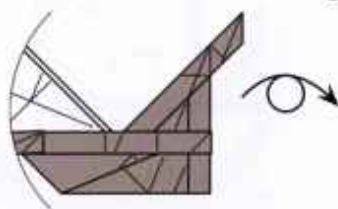

Turn over.  
翻面

60

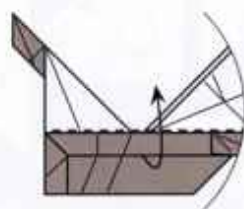

Valley-fold.  
谷折

61

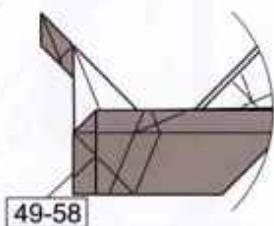

Repeat step 49 to 58.  
重复步骤49-58

62

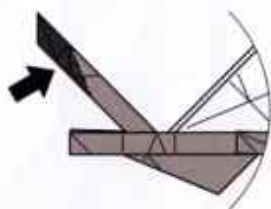

Open sink.  
开放沉折

63

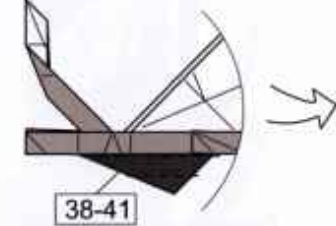

Repeat step 38-41. Zoom out.  
重复步骤38-41, 视图复原

64

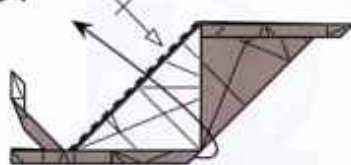

Valley-fold. Repeat behind.  
谷折, 后侧重复

65

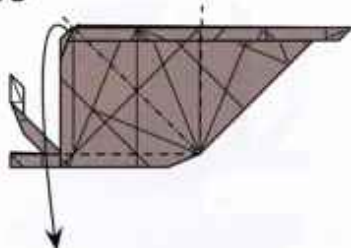

Swivel-fold.  
旋转折

66

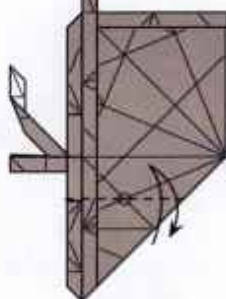

Fold then unfold.  
留下折痕

67

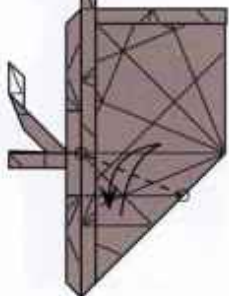

Crease according to the marked points.  
依参考点留下折痕

68

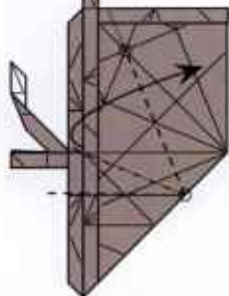

Swivel-fold.  
旋转折

69

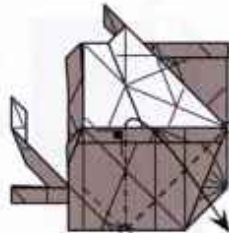

Swivel-fold. The model will not stay flat.  
旋转折, 模型无法压平

82

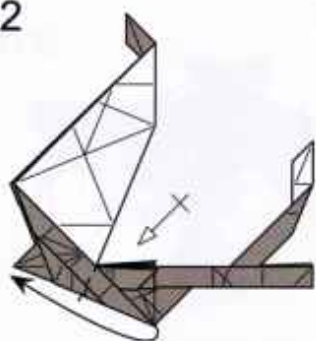

Fold one layer to the left.Repeat behind.  
向左谷折一层, 后侧重复

83

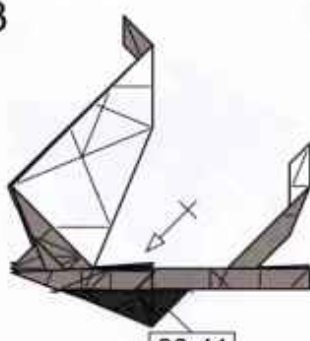

Repeat step 38 to 41.Repeat behind.  
重复步骤38-41,后侧重复

84

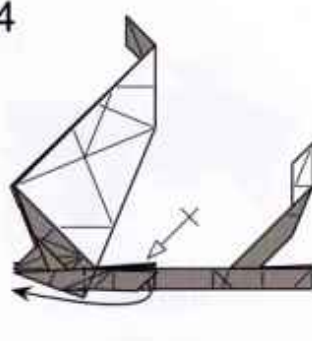

Fold one layer to the left.Repeat behind.  
向左谷折一层, 后侧重复

85

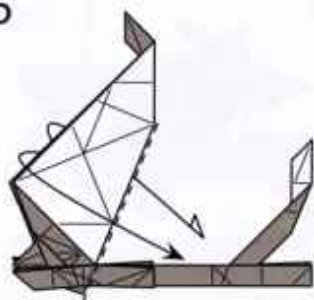

Outside reverse-fold.  
外翻折

86

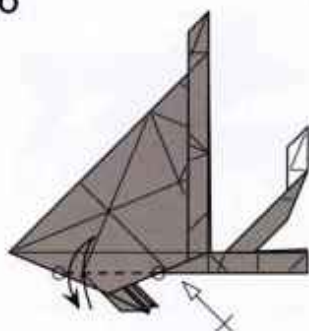

Pre-crease.Repeat behind.  
留下折痕, 后侧重复

87

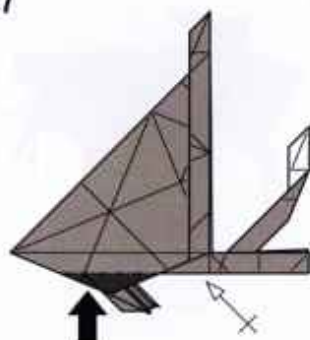

Open sink.Repeat behind.  
开放沉折, 后侧重复

88

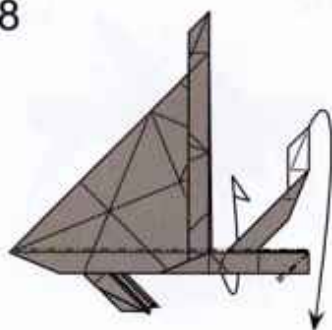

Fold up the back layers.  
后方纸层向上翻折

89

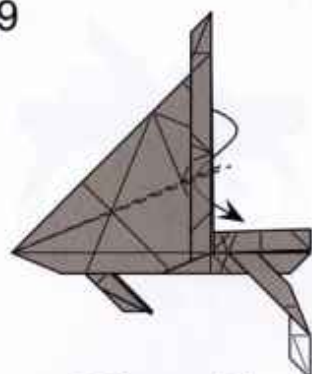

Inside reverse-fold.  
内翻折

90

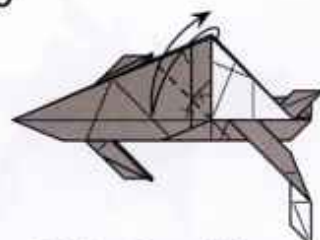

Fold along the angle bisectors  
and unfold.  
沿角平分线留下折痕

91

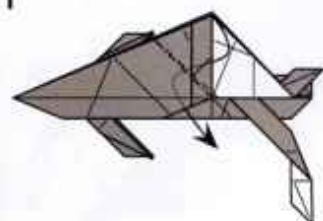

Reverse-fold all layers.  
所有纸层翻折

92

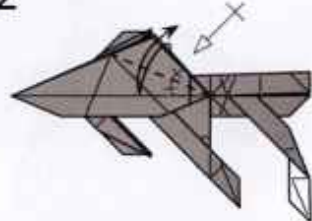

Fold along the angle bisectors  
and unfold.Repeat on the other flap.  
沿角平分线留下折痕, 另一片重复

93

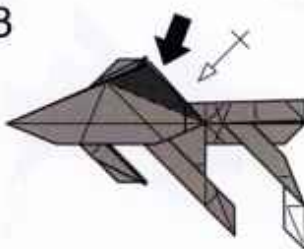

Open sink.Repeat on the other flap.  
开放沉折, 另一片重复

94

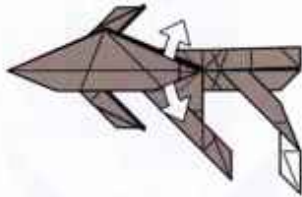

Pull out the hidden layer.  
引出内部纸层

95

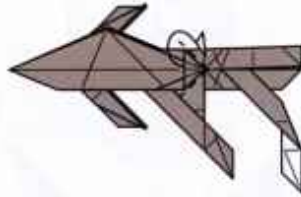

Unwrap.  
翻出纸层

96

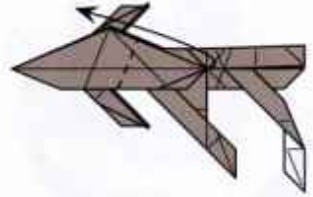

Valley-fold.  
谷折

97

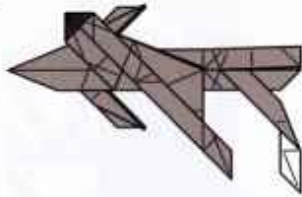

Unwrap.  
翻出纸层

98

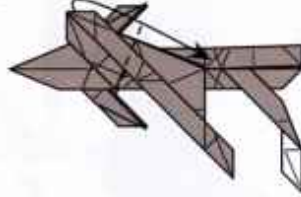

Valley-fold.  
谷折

99

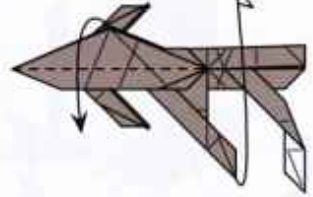

Valley-fold and adjust the layers.  
谷折调整纸层

100

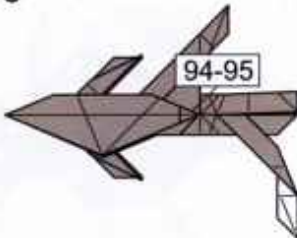

Repeat step 94 to 95.  
重复步骤94-95

101

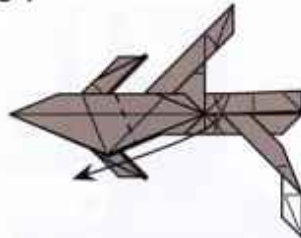

Valley-fold.  
谷折

102

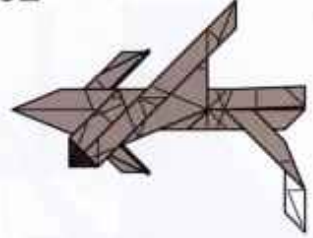

Unwrap.  
翻出纸层

103

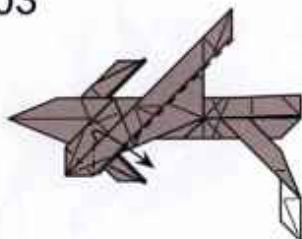

Swivel-fold and open the layer.  
The model will not stay flat.  
旋转折打开纸层，模型无法压平

104

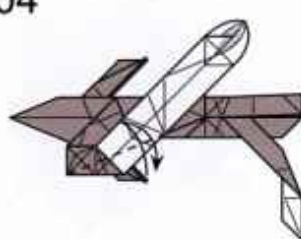

Fold then unfold.  
留下折痕

105

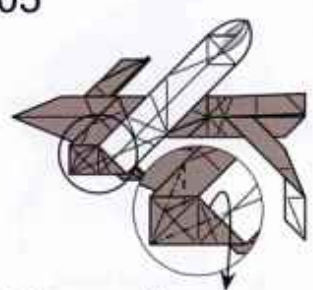

Collapse according to the creases.  
按峰谷聚合

106

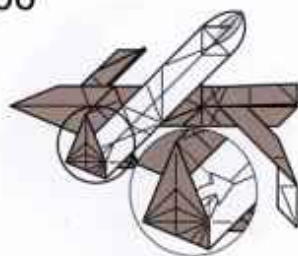

Pull out the hidden layer.  
引出内部纸层

107

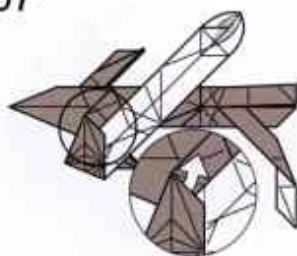

Pull out the hidden layer.  
引出内部纸层

108

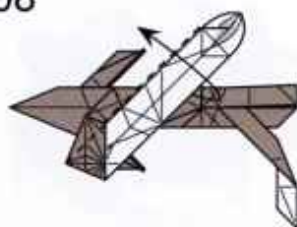

Valley-fold.  
谷折

109

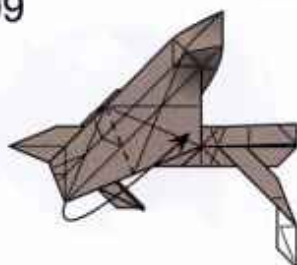

Valley-fold.  
谷折

110

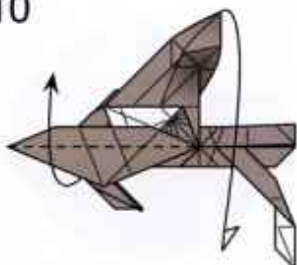

Valley-fold and adjust the layers.  
谷折调整纸层

111

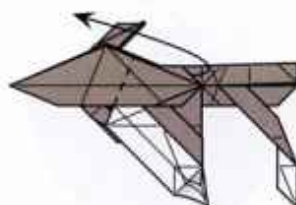

Valley-fold.  
谷折

112

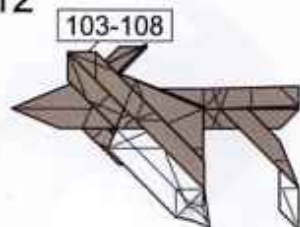

Repeat step 103 to 108.  
重复步骤103-108

113

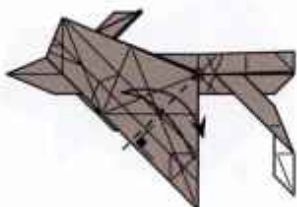

Fold then unfold.  
留下折痕

114

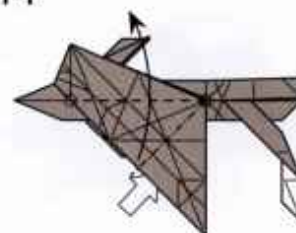

Squash fold.  
撑开压平

115

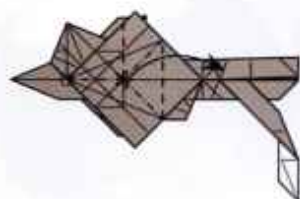

Pull the point marked with ☆  
to the right.  
将☆标注的点向右折

116

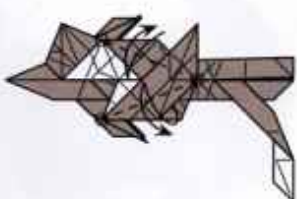

Pre-crease.  
留下折痕

117

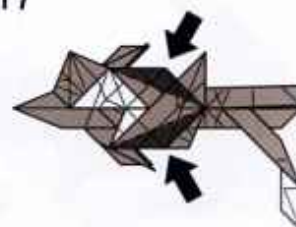

Open sink.  
开放沉折



118

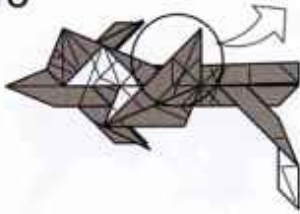

Zoom in.  
局部视图放大

119

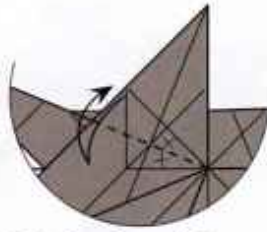

Fold along the angle bisector  
and unfold.  
沿角平分线留下折痕

120

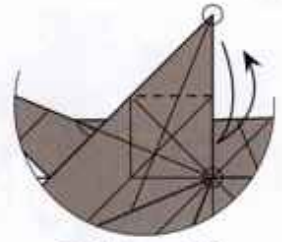

Fold then unfold.  
留下折痕

121

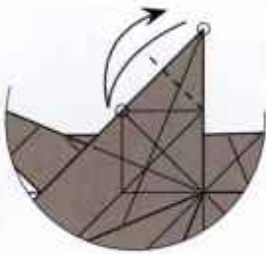

Fold then unfold.  
留下折痕

122

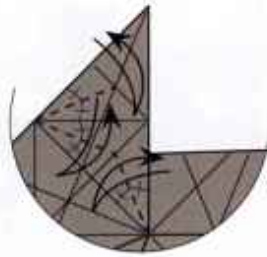

Fold along the angle bisectors  
and unfold.  
沿角平分线留下折痕

123

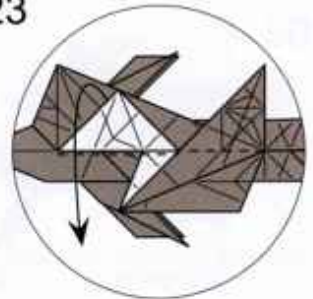

Valley-fold.  
谷折

124

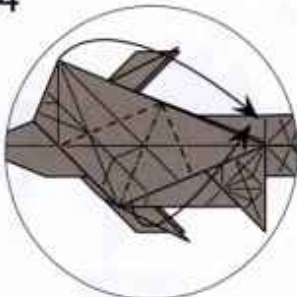

Collapse according to the creases.  
按峰谷聚合

125

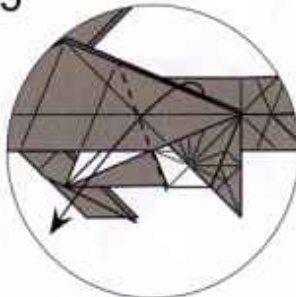

Fold one layer to the left.  
向左谷折一层

126

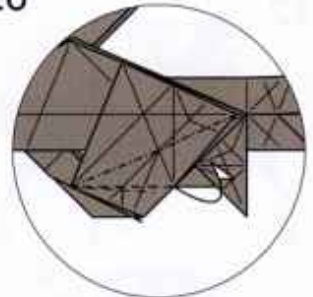

Swivel-fold.  
旋转折

127

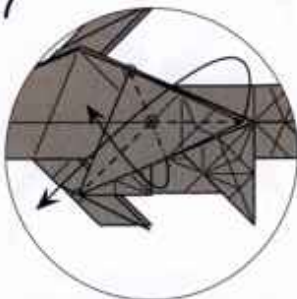

Collapse according to the creases.  
按峰谷聚合

128

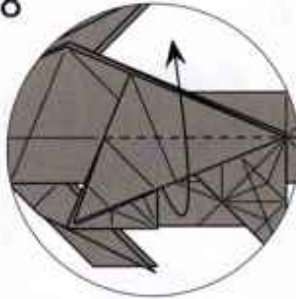

Valley-fold.  
谷折

129

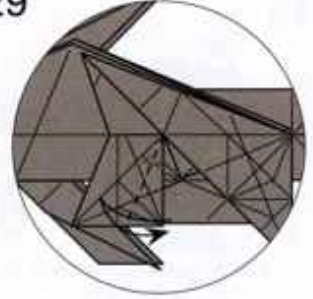

Fold along the angle bisector  
and unfold.  
沿角平分线留下折痕

130

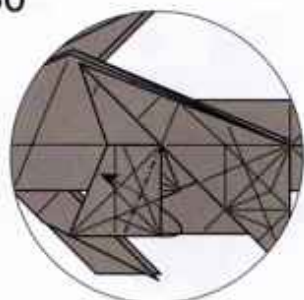

Inside reverse-fold.  
内翻折

131

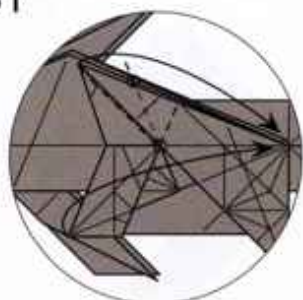

Swivel-fold.  
旋转折

132

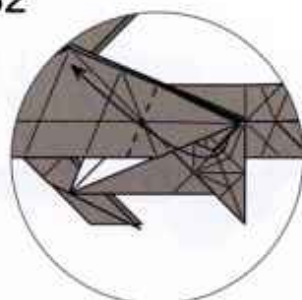

Fold one layer to the left.  
向左谷折一层

133

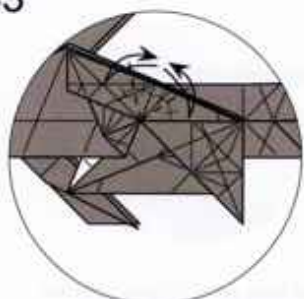

Fold along the angle bisectors  
and unfold.  
沿角平分线留下折痕

134

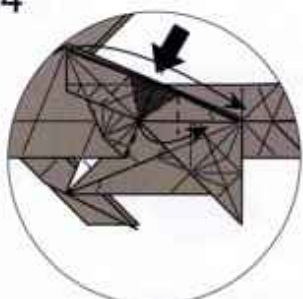

Collapse according to the creases.  
按峰谷聚合

135

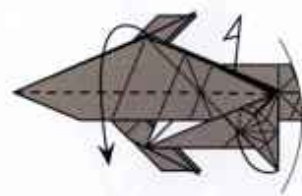

Valley-fold and adjust the layers.  
谷折调整纸层

136

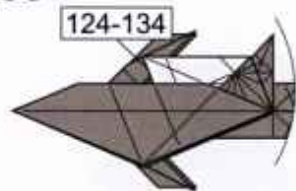

Repeat step 124-134.  
重复步骤124-134

137

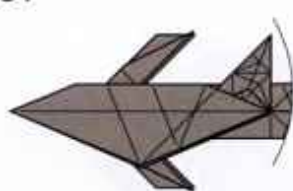

Zoom out. Turn over.  
视图复原, 翻面

138

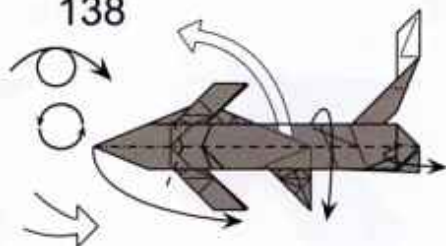

Collapse according to the creases.  
按峰谷聚合

139

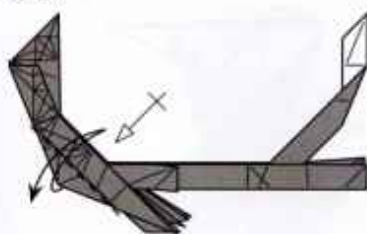

Fold then unfold. Repeat behind.  
留下折痕, 后侧重复

140

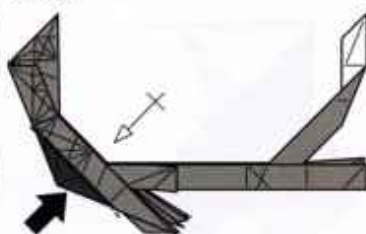

Open sink. Repeat behind.  
开放沉折, 后侧重复

141

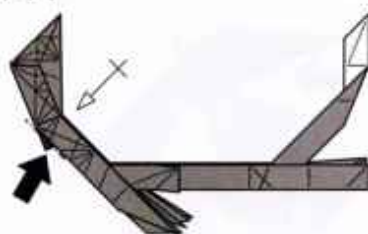

Open sink. Repeat behind.  
开放沉折, 后侧重复

154

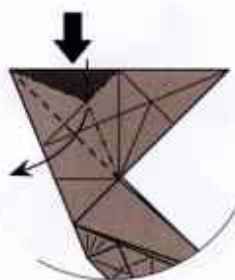

Collapse according to the creases.  
按峰谷聚合

155

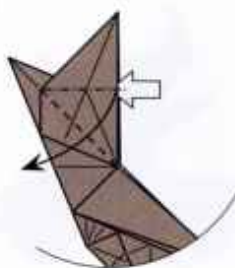

Squash fold.  
撑开压平

156



Petal-fold.  
花瓣折

157

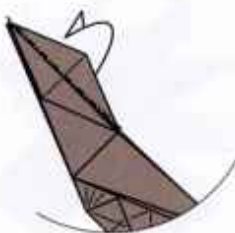

Mountain-fold.  
峰折

158

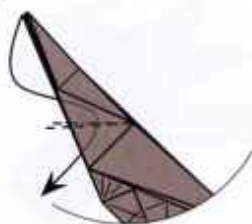

Inside reverse-fold.  
内翻折

159

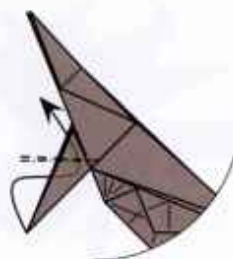

Inside reverse-fold.  
内翻折

160

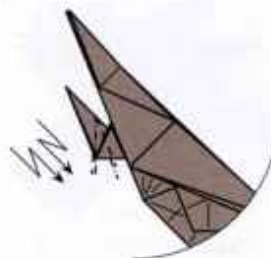

Crimp.  
双向段折

161



Swivel-fold.Repeat behind.  
旋转折, 后侧重复

162

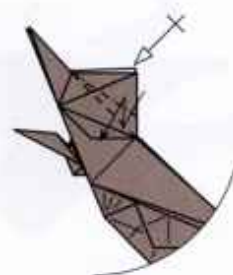

Pleat-fold.Repeat behind.  
段折, 后侧重复

163



Swivel-fold.Repeat behind.  
旋转折, 后侧重复

164



Pull out the hidden layer.Repeat behind.  
引出内部纸层, 后侧重复

165



Outside reverse-fold.  
外翻折

166

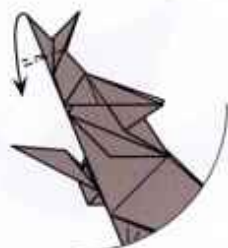

Inside reverse-fold.  
内翻折

167

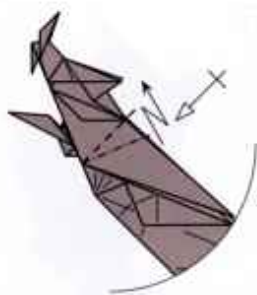

Pleat-fold.Repeat behind.  
段折, 后侧重复

168

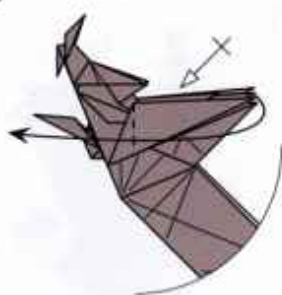

Fold one flap to the left.Repeat behind.  
向左谷折一片, 后侧重复

169



Swivel-fold.Repeat behind.  
旋转折, 后侧重复

170

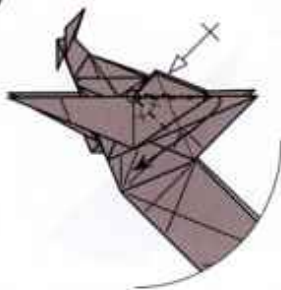

Swivel-fold.Repeat behind.  
旋转折, 后侧重复

171



Swivel-fold.Repeat behind.  
旋转折, 后侧重复

172

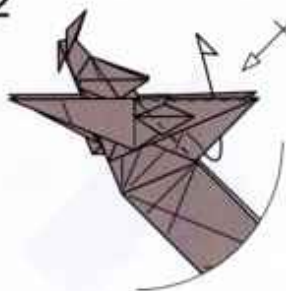

Swivel-fold.Repeat behind.  
旋转折, 后侧重复

173

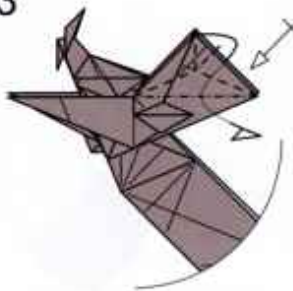

Collapse according to the creases.  
按峰谷聚合

174

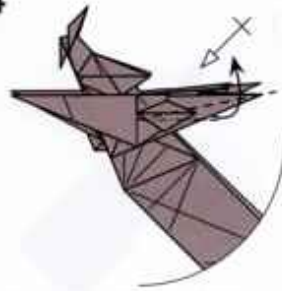

Pleat-fold.Repeat behind.  
段折, 后侧重复

175

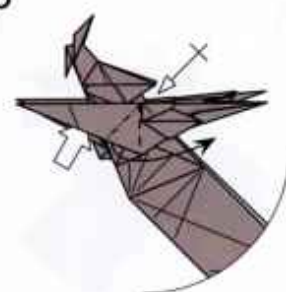

Squash fold.Repeat behind.  
撑开压平, 后侧重复

176

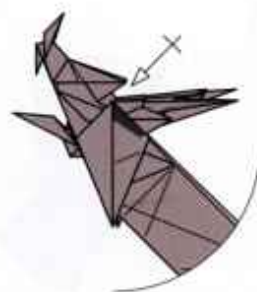

Bring the hidden layers to the front.  
Repeat behind.  
将纸层调整至表面, 后侧重复

177

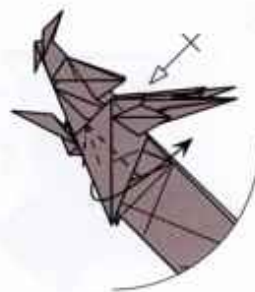

Swivel-fold.Repeat behind.  
旋转折, 后侧重复

178

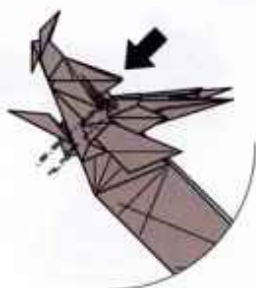

Crimp.  
双向段折

179



Crimp.  
双向段折

180



Pull out the hidden layer.  
Repeat behind.  
引出内部纸层, 后侧重复

181



Fold one flap up. Repeat behind.  
向上谷折一片, 后侧重复

182

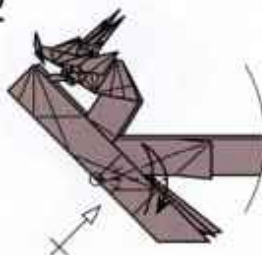

Fold along the angle bisectors  
and unfold. Repeat behind.  
沿角平分线留下折痕, 后侧重复

183

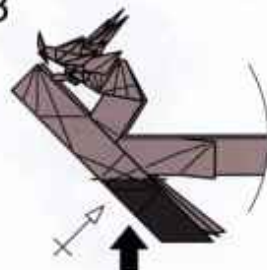

Open sink. Repeat behind.  
开放沉折, 后侧重复

184



Pleat-fold. Repeat behind.  
段折, 后侧重复

185



Fold along the angle bisector.  
Repeat behind.  
沿角平分线折叠, 后侧重复

186



Crimp.  
双向段折

187



Crimp.  
双向段折

188

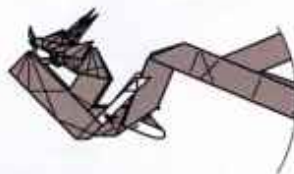

Valley-fold to hide the corner.  
谷折藏起纸角

189



Valley-fold.  
谷折

190

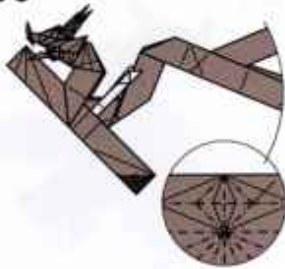

Adjust the layers according to the crease.  
按峰谷调整纸层

191



Valley-fold.  
谷折

192

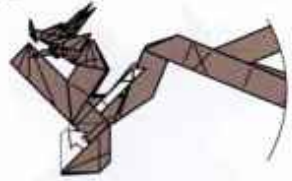

Pull out the hidden layer.  
引出内部纸层

193

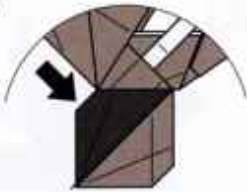

Open sink.  
开放沉折

194

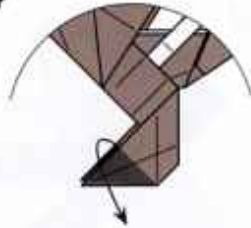

Unfold the shaded layers.  
打开阴影处纸层

195

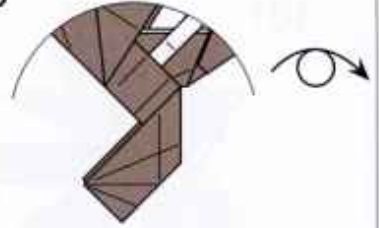

Turn over.  
翻面

196

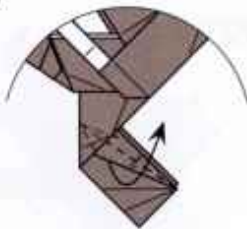

Swivel-fold.  
旋转折

197

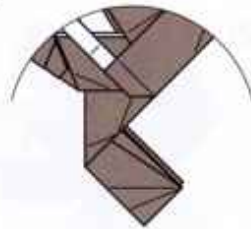

Turn over.  
翻面

198

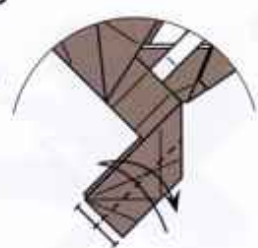

Pre-crease.  
留下折痕

199

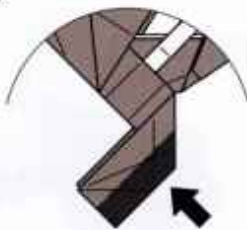

Closed sink.  
闭合沉折

200

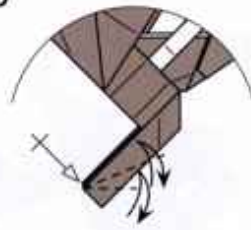

Fold then unfold.  
Repeat on the other flap.  
留下折痕, 另一片重复

201

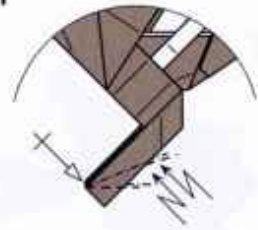

Crimp. Repeat on the other flap.  
双向段折, 另一片重复

202



Mountain-fold.  
峰折

203



Collapse according to the creases.  
按峰谷聚合

204



Outside reverse-fold.  
外翻折

205

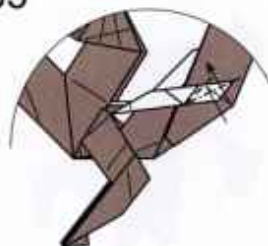

Pleat-fold.  
段折

206



Turn over.  
翻面

207

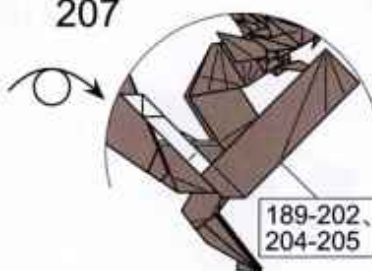

Repeat step 189 to 202, 204-205.  
另一側重复步骤189-202、204-205

208



Pleat-fold.  
段折

209



Pleat-fold.  
段折

210



Turn over.  
翻面

211



Shape the paw.  
整形爪子

212



Change view.  
转换视角

213

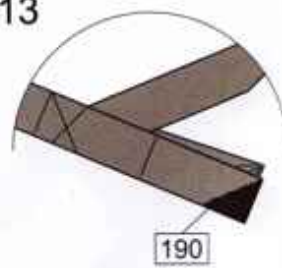

Repeat step 190.  
重复步骤190

214

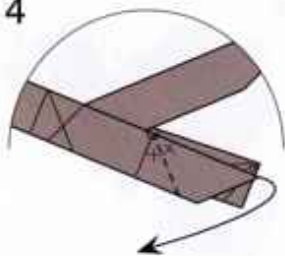

Fold along the angle bisectors.  
沿角平分线折叠

215

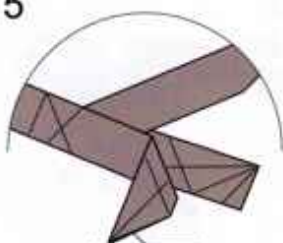

Repeat step 192 to 195.  
重复步骤192-195

216

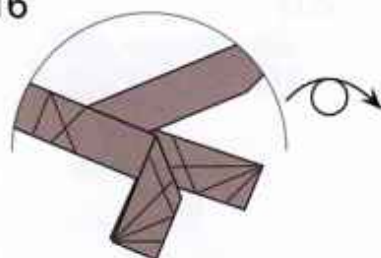

Turn over.  
翻面

217

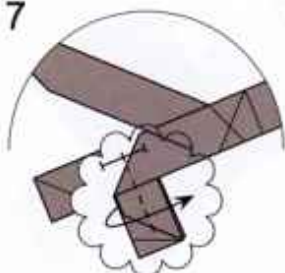

X-ray view. Valley-fold.  
透视图角. 谷折

218

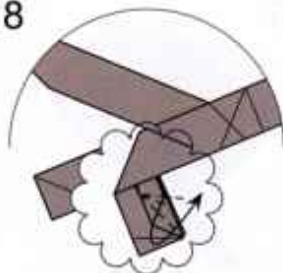

X-ray view. Swivel-fold.  
透视图角. 旋转折

219

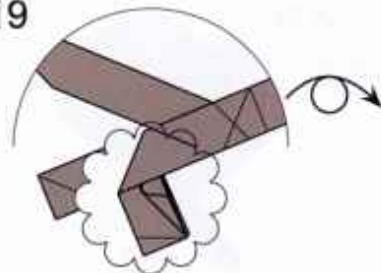

Turn over.  
翻面

220



Repeat step 198 to 201.  
重复步骤198-201

221

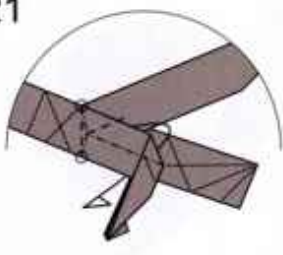

Collapse according to the creases.  
按峰谷聚合

222

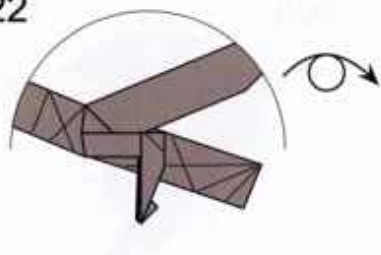

Turn over.  
翻面

223

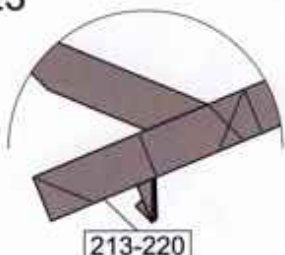

Repeat step 213 to 220.  
重复步骤213-220

224

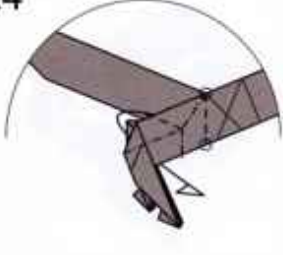

Collapse according to the creases.  
按峰谷聚合

225

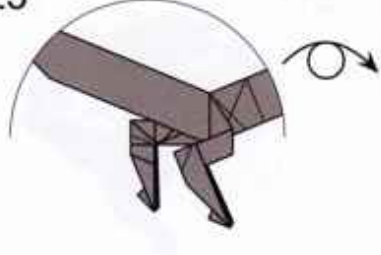

Turn over.  
翻面



226

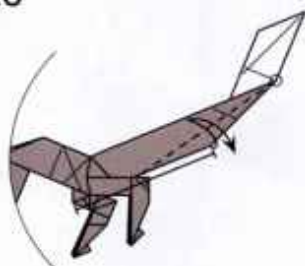

Fold and unfold all layers.  
所有纸层折出折痕

227

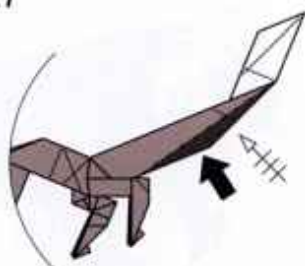

Open sink.  
Repeat on the other three flaps.  
开放沉折, 另外三片重复

228

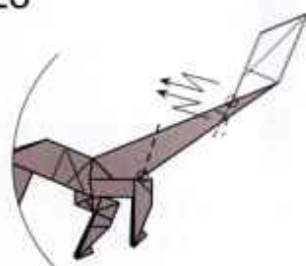

Crimp.  
双向段折

229



Pleat-fold.  
段折

230

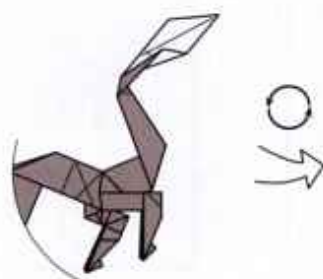

Zoom out.  
视图复原

231



Shape the model.  
整形

232



Complete!  
完成!

# 龙

Dragon

设计 / Designed: 刘晓阳 Liu Xiaoyang  
 图示 / Diagram: 银铃 Yin Ling

推荐用纸 / Paper:  
 - Kami 70x70 cm

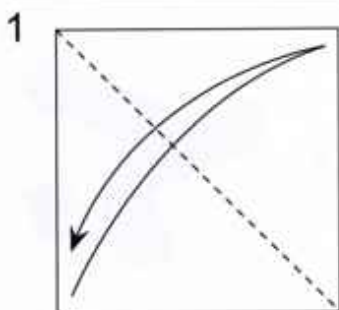
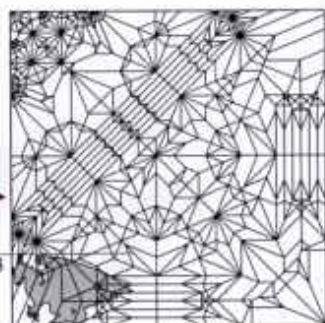

Fold then unfold  
 留下折痕

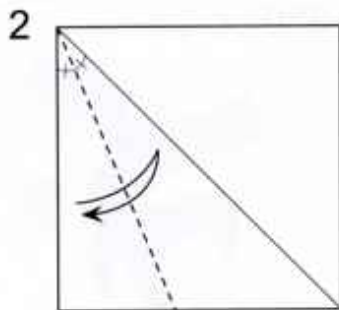

Fold along the angle bisector  
 and unfold.  
 沿角平分线留下折痕

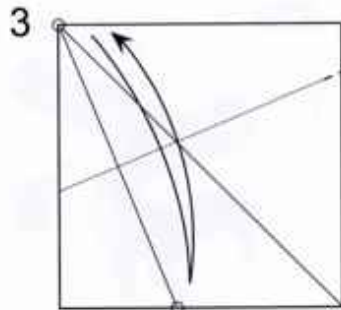

Crease according to the marked points.  
 依参考点留下折痕

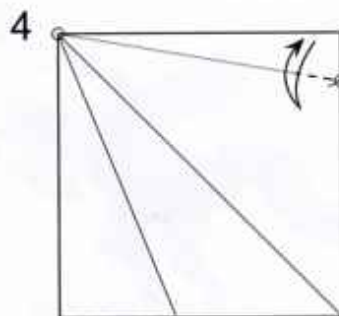

Crease according to the marked points.  
 依参考点留下折痕

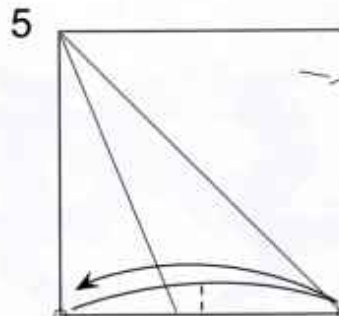

Crease according to the marked points.  
 依参考点留下折痕

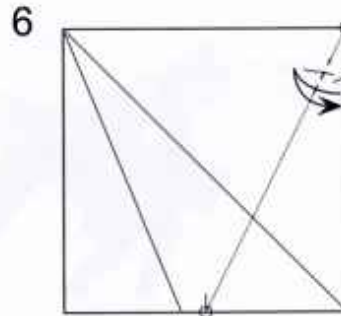

Crease according to the marked points.  
 依参考点留下折痕

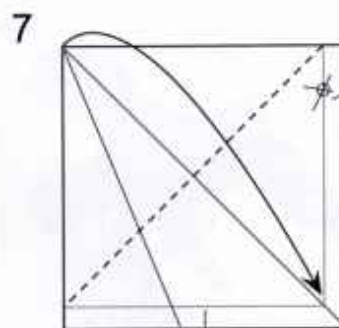

Crease according to the marked points.  
 依参考点留下折痕

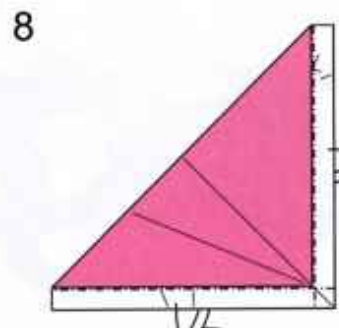

Mountain-fold along the edges  
 then unfold.  
 沿边缘峰折留下折痕

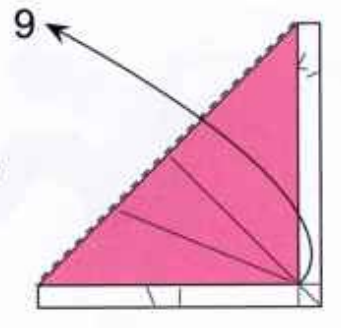

Unfold.  
 打开

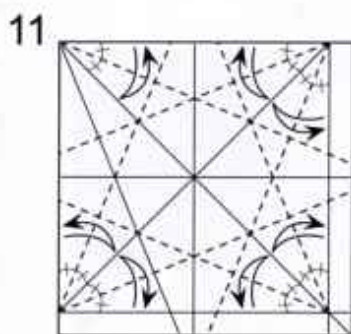
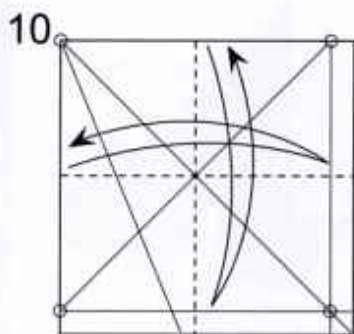

Fold along the angle bisectors  
and unfold.  
沿角平分线留下折痕

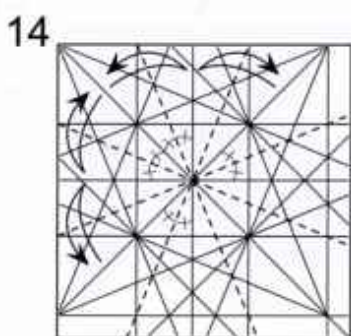
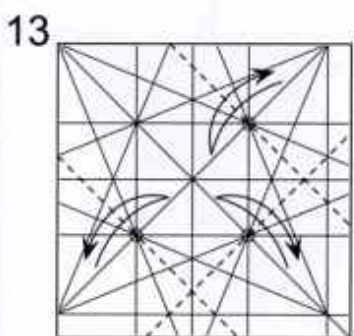
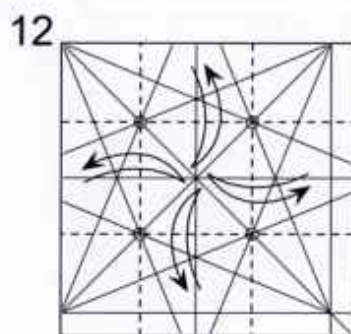

Fold along the angle bisectors  
and unfold.  
沿角平分线留下折痕

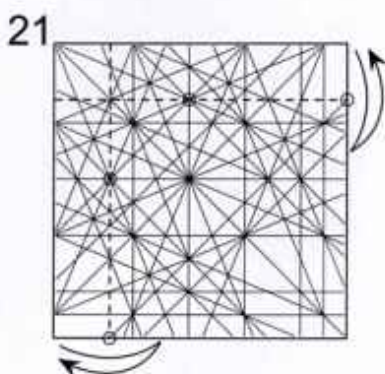
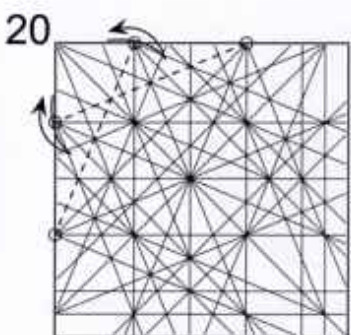
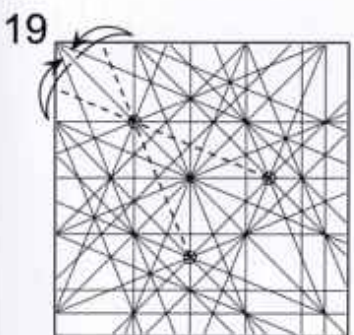
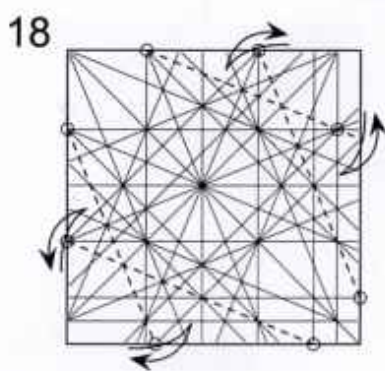
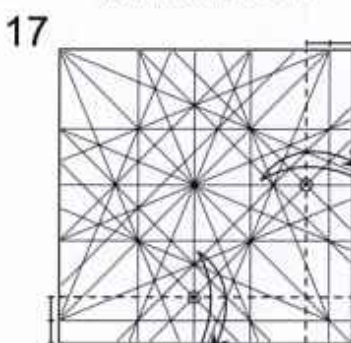
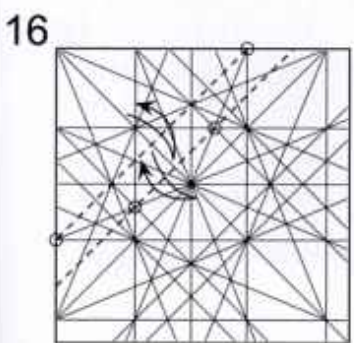
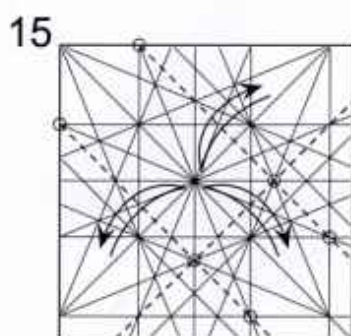

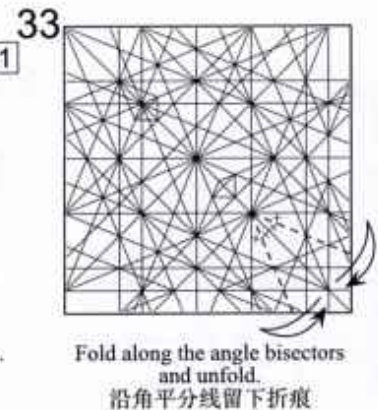
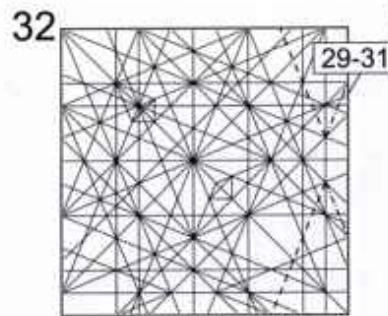
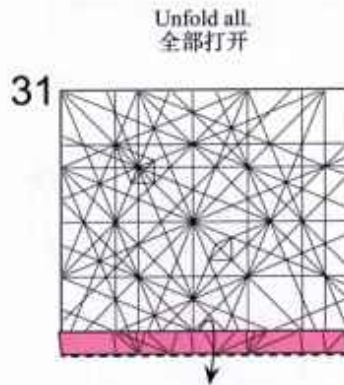
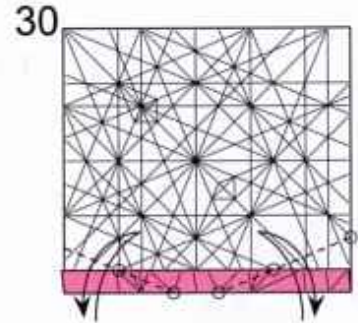
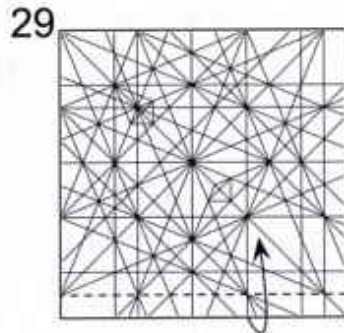
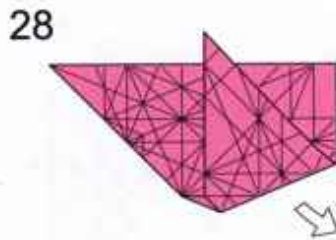
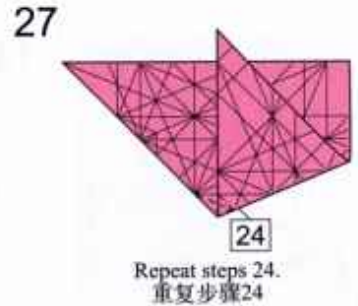
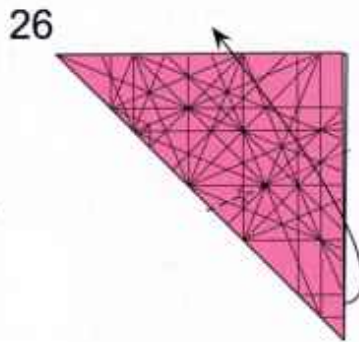
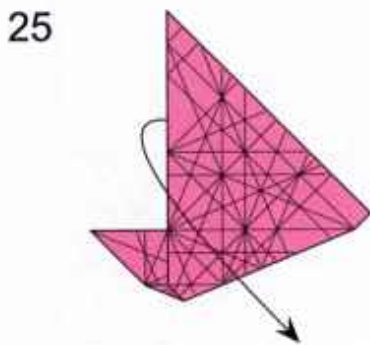
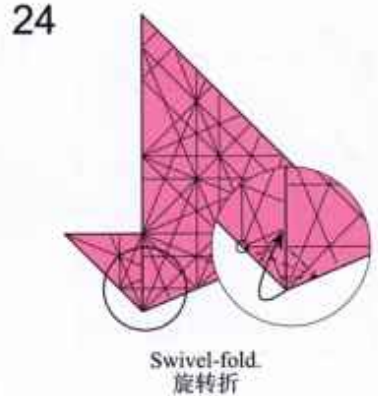
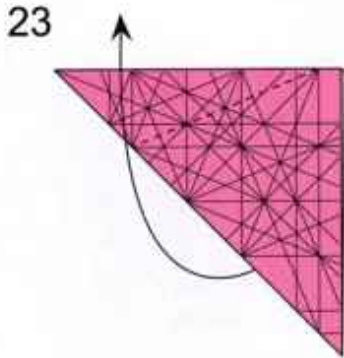
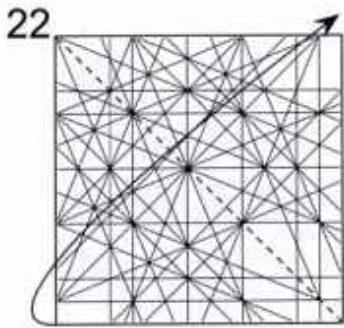

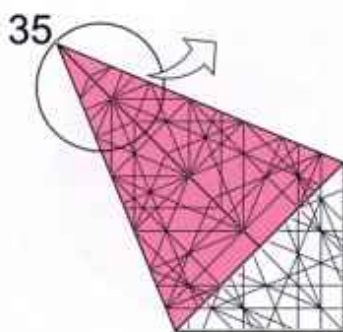
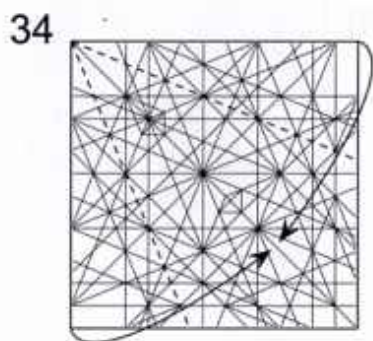

Zoom in.  
局部视图放大

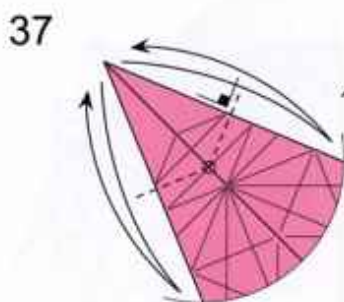
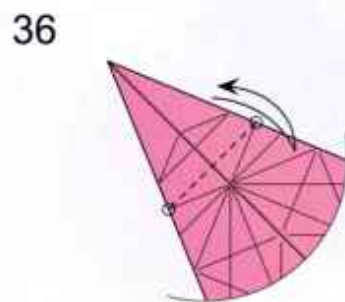

Turn over.  
翻面

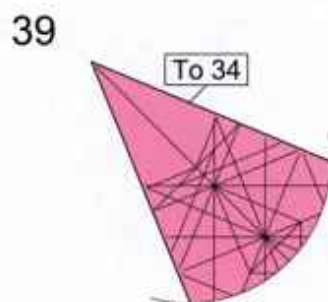
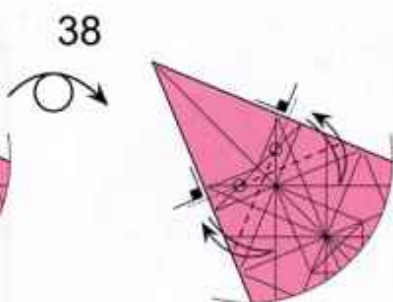

Unfold to step 34.  
复原至步骤34

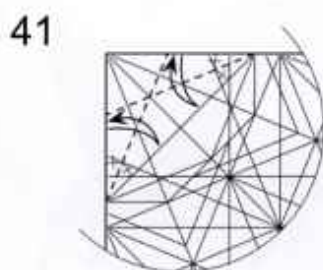
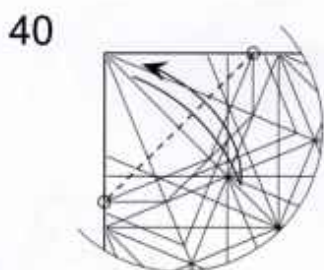

Fold along the angle bisectors  
and unfold.  
沿角平分线留下折痕

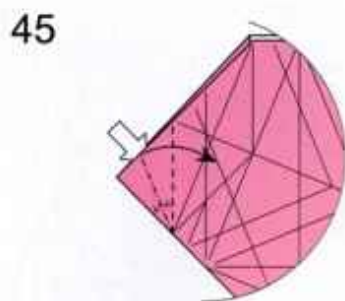
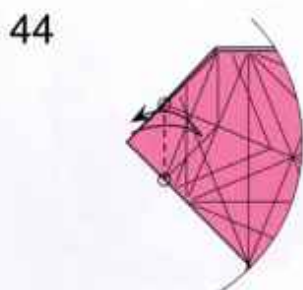
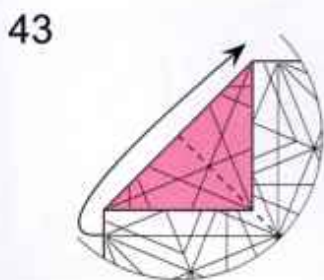
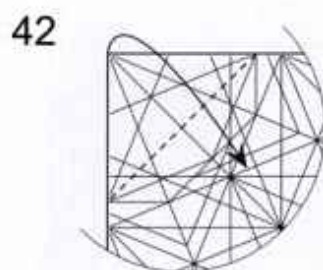

Squash fold.  
撑开压平

46



Petal-fold.  
花瓣折

47

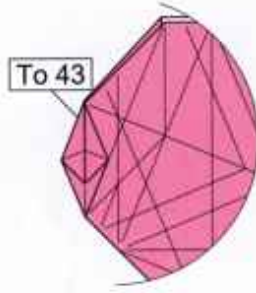

Unfold to step 43.  
复原至步骤43

48

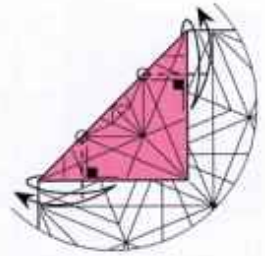

49

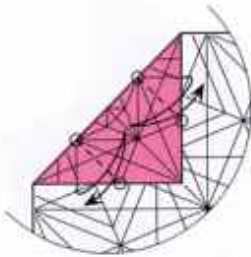

50

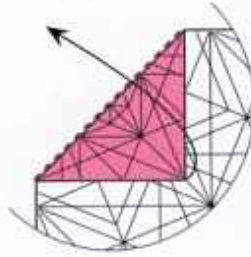

51

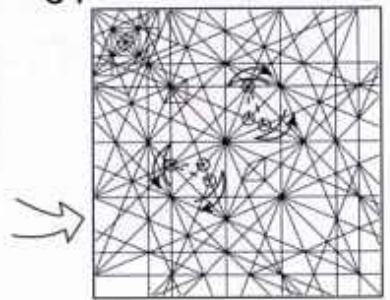

52

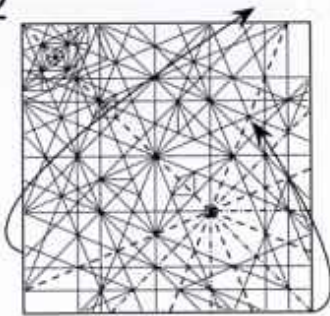

Collapse according to the creases.  
按峰谷聚合

53

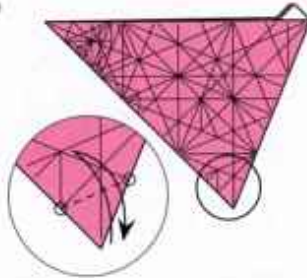

54

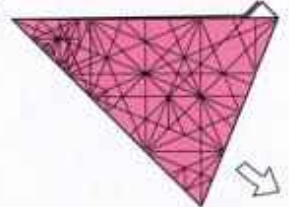

Unfold all.  
全部打开

55

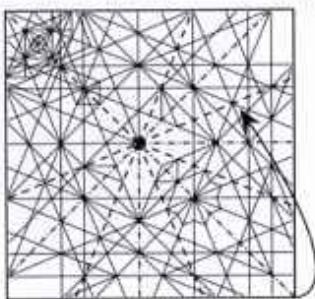

Collapse according to the creases.  
按峰谷聚合

56

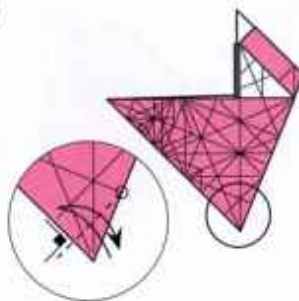

57

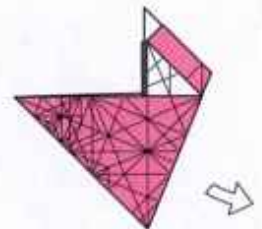

Unfold all.  
全部打开

58

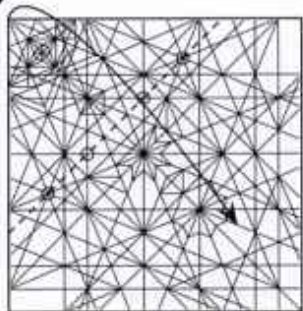

59

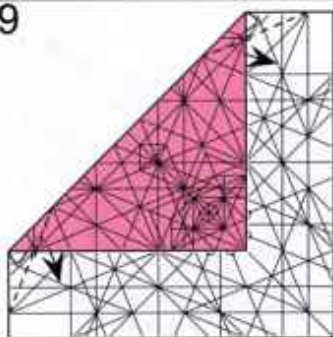

60

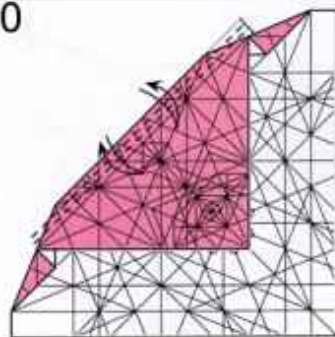

Inside reverse-fold.  
内翻折

61

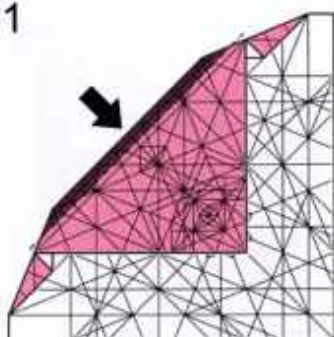

Open sink.  
开放沉折

62

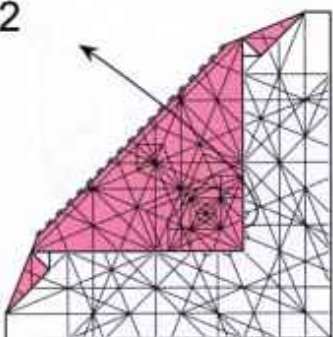

Open the layer.  
打开纸层

63

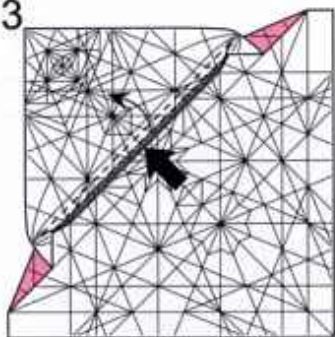

Spread sink.  
延展沉折

64

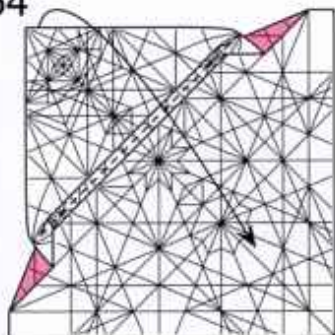

65

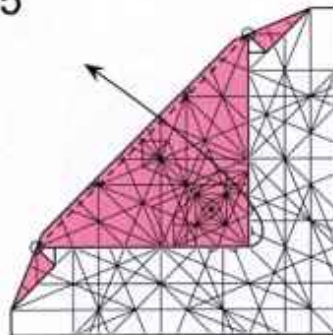

66

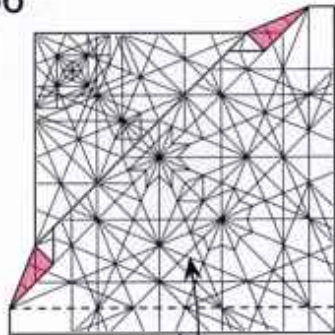

67

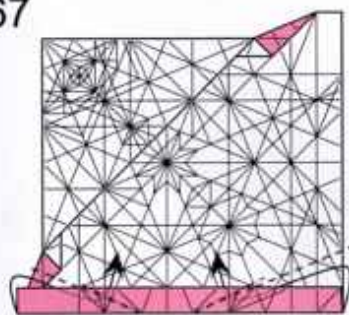

Inside reverse-fold.  
内翻折

68

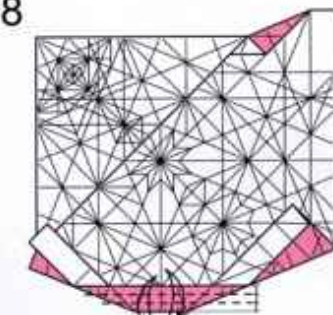

69

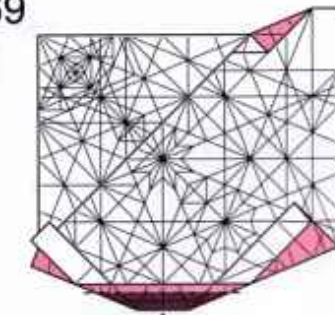

Open sink.  
开放沉折

70

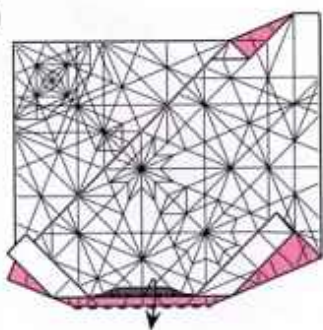

Spread sink.  
延展沉折

71

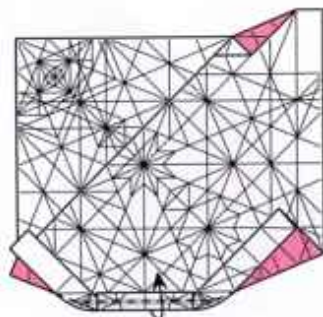

72

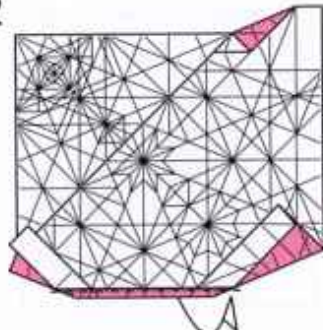

73

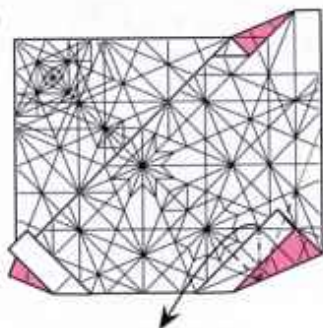

Swivel-fold.  
旋转折

74

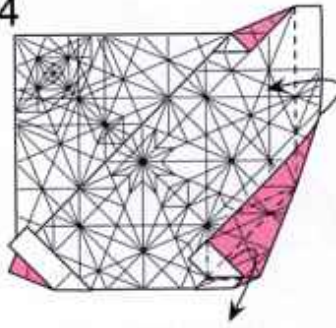

Swivel-fold along the creases.  
沿折痕旋转折

75

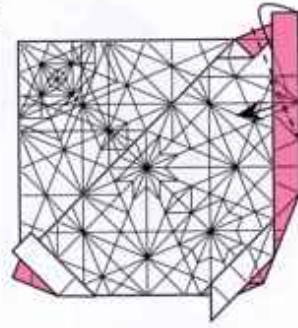

Inside reverse-fold.  
内翻折

76

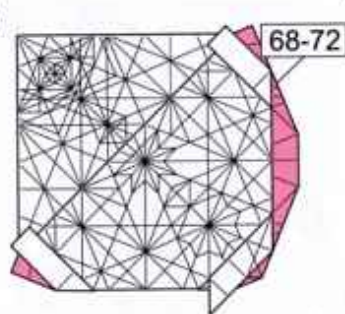

Repeat steps 68 to 72 on the other side.  
另一侧重复步骤68-72

77

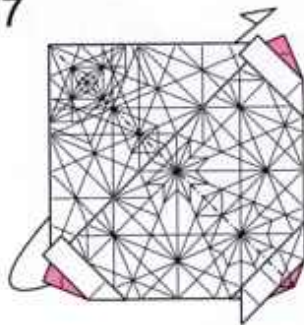

78

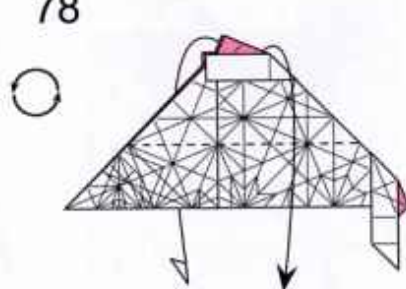

79

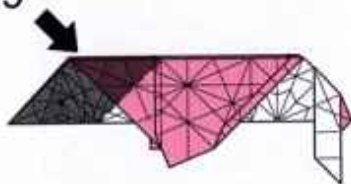

Open sink.  
开放沉折

80

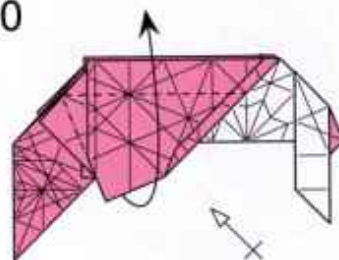

Petal-fold. Repeat behind.  
花瓣折, 后侧重复

81

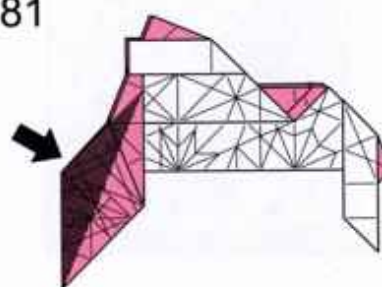

Open sink.  
开放沉折



82

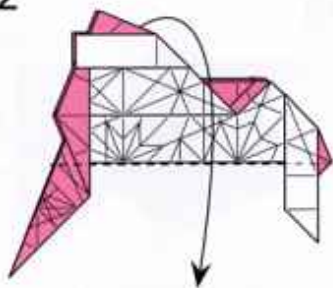

83

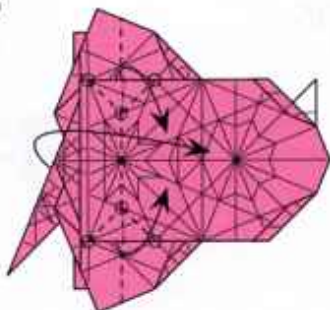

Inside reverse-fold then  
flatten teh model along the crease.  
内翻折并沿峰谷压平

84

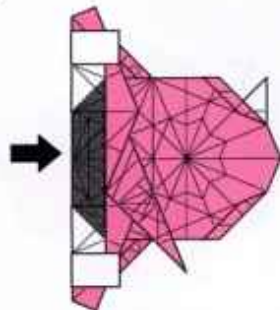

Open sink the shaded area.  
阴影部分开放沉折

85

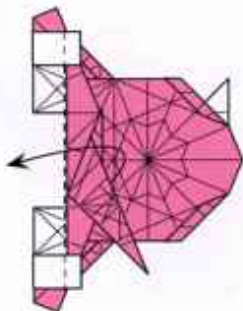

86

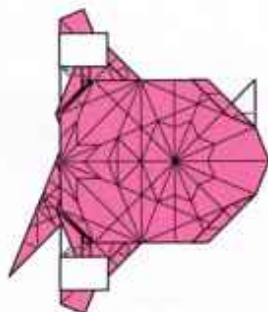

Turn over.  
翻面

87

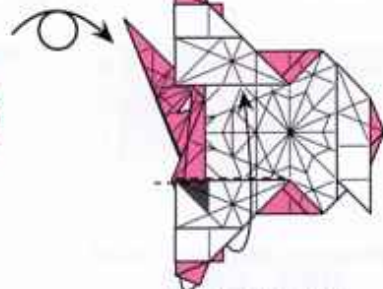

Outside reverse-fold.  
外翻折

88

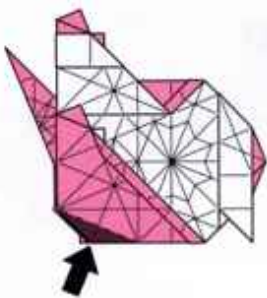

Open sink.  
开放沉折

89

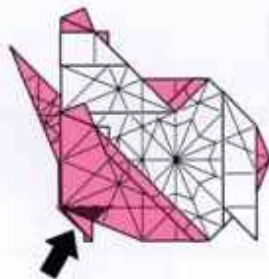

Open sink the hidden layers.  
内部纸层开放沉折

90

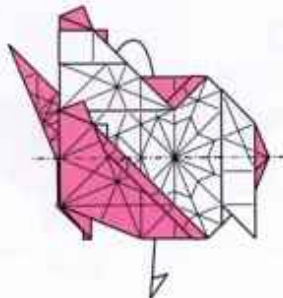

91

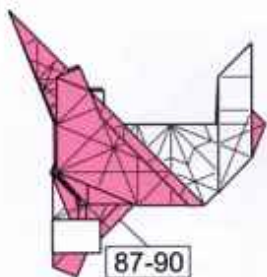

Repeat steps 87 to 90 on the other side.  
另一侧重复步骤10-15

92

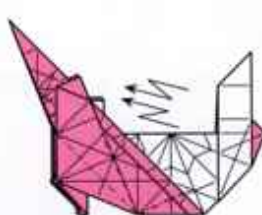

Crimp.  
双向段折

93

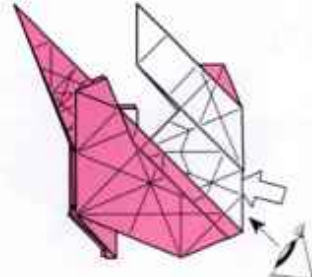

Change perspective.  
视角转换

94

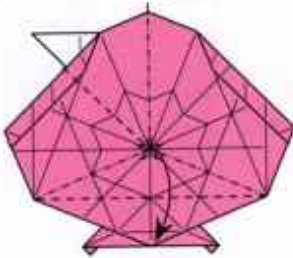

Pull down the point marked with ☆.  
将☆标注的点下拉

95

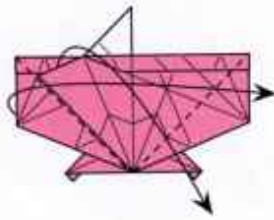

96

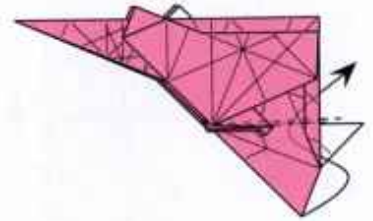

Inside reverse-fold.  
内翻折

97

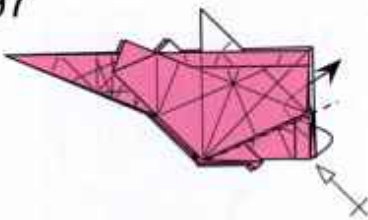

Inside reverse-fold. Repeat behind.  
内翻折, 后侧重复

98

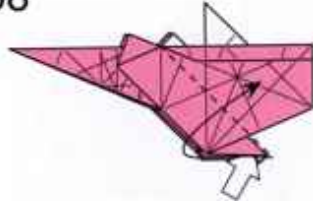

Squash fold.  
撑开压平

99

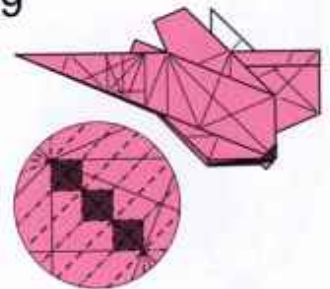

Adjust the layers  
according to the creases.  
按峰谷调整纸层

100

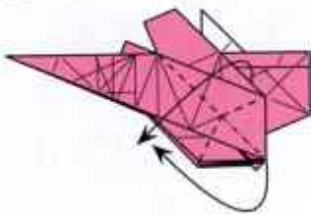

101

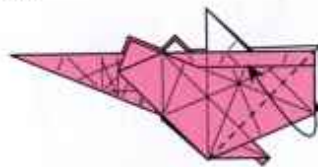

102

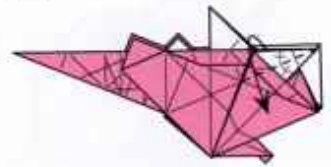

103

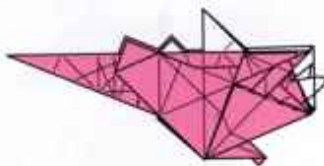

104

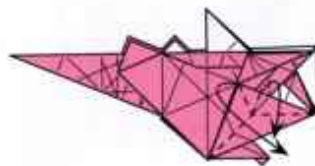

105

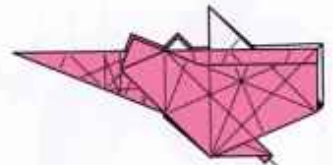

98-104

Repeat steps 98 to 104 on the other side.  
另一侧重复步骤98-104

106

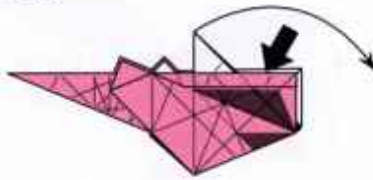

Open sink and pull out the hidden layer.  
开放沉折引出内部纸层

107



Swivel-fold.  
旋转折

108



Swivel-fold.  
旋转折

109

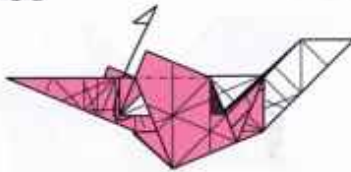

Pull out the hidden layer  
and pull the layer up.  
引出内部纸层并上拉

110

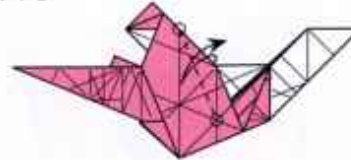

111

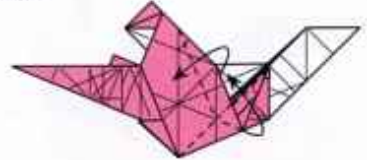

112



113

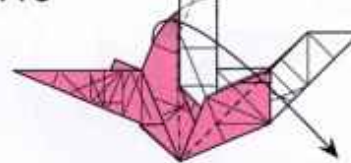

Swivel-fold to flatten the model.  
旋转折压平

114



Repeat steps 107 to 113 on the other side.  
另一侧重复步骤107-113

115

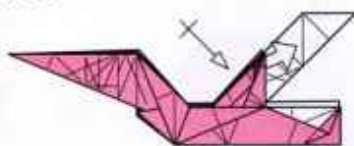

Pull out the hidden layer.  
Repeat behind.  
引出内部纸层, 后侧重复

116

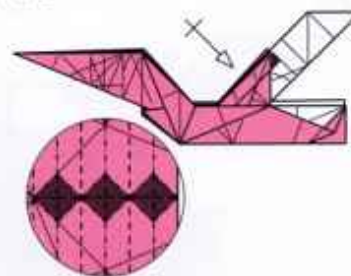

Adjust the layers according to  
the creases. Repeat behind.  
按峰谷调整纸层, 后侧重复

117

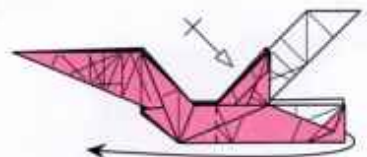

118

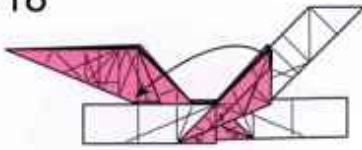

119

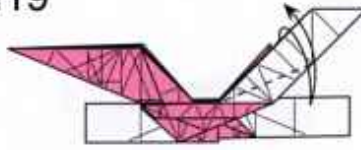

120

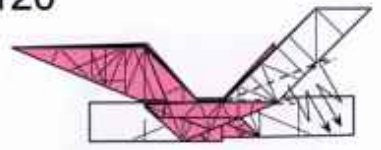

Crimp.  
双向段折

121

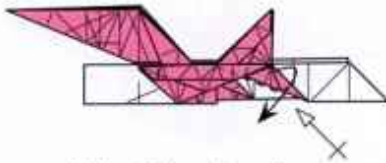

Valley-fold one layer down.  
Repeat behind.  
向下谷折一层，后侧重复

122

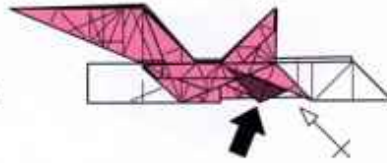

Closed sink. Repeat behind.  
闭合沉折，后侧重复

123

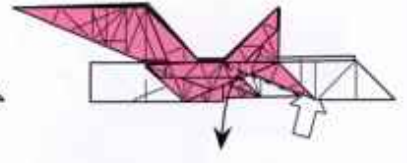

Squash fold. The model will not stay flat.  
撑开纸层，模型无法压平

124

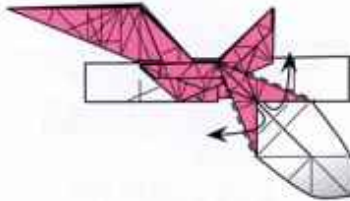

125

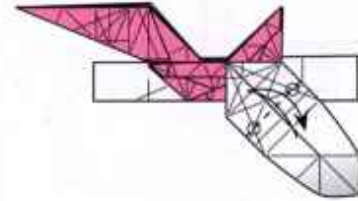

126

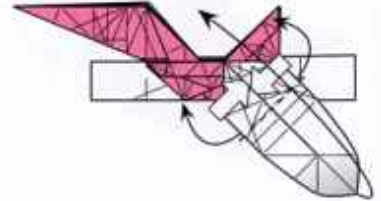

Open the layers  
and flatten along the creases.  
打开纸层并沿峰谷压平

127

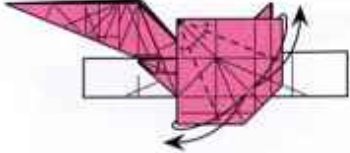

128

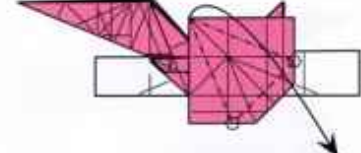

Petal-fold.  
花瓣折

129

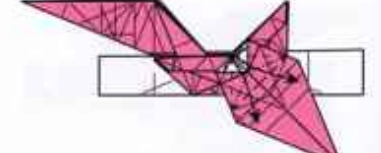

Swivel-folds.  
旋转折

118

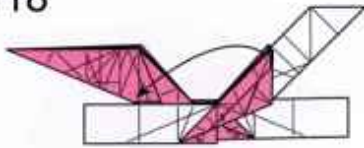

119

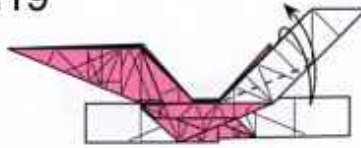

120

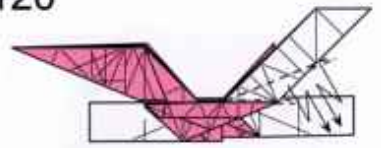

Crimp.  
双向段折

121

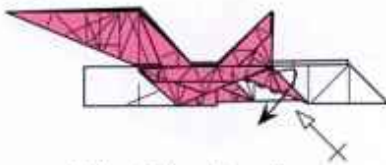

Valley-fold one layer down.  
Repeat behind.  
向下谷折一层，后侧重复

122

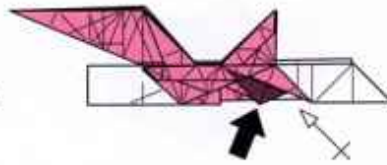

Closed sink. Repeat behind.  
闭合沉折，后侧重复

123

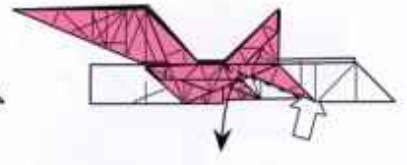

Squash fold. The model will not stay flat.  
撑开纸层，模型无法压平

124

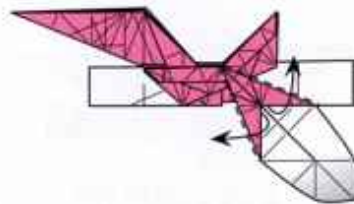

125

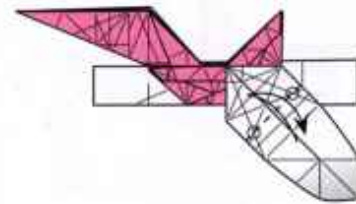

126

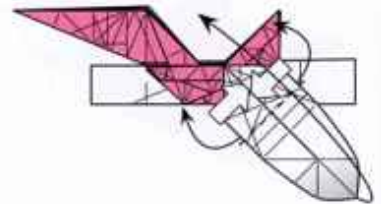

Open the layers  
and flatten along the creases.  
打开纸层并沿峰谷压平

127

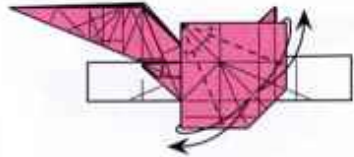

128

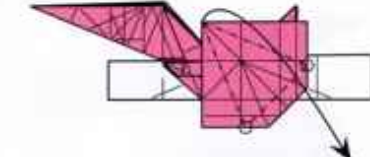

Petal-fold.  
花瓣折

129

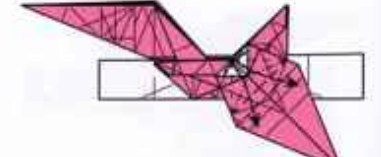

Swivel-folds.  
旋转折

118

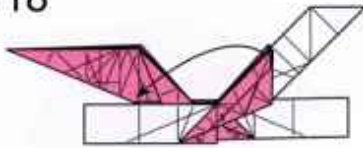

119

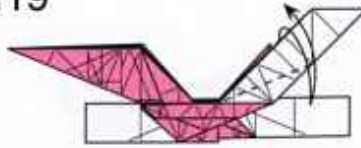

120



Crimp.  
双向段折

121

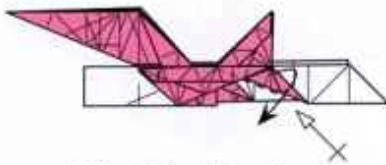

Valley-fold one layer down.  
Repeat behind.  
向下谷折一层，后侧重复

122

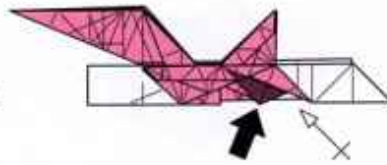

Closed sink. Repeat behind.  
闭合沉折，后侧重复

123

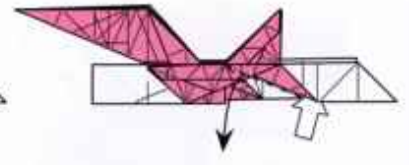

Squash fold. The model will not stay flat.  
撑开纸层，模型无法压平

124

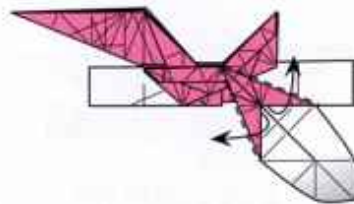

125

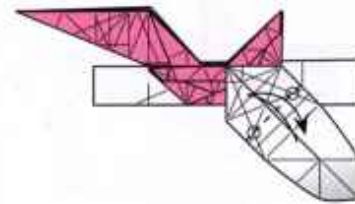

126

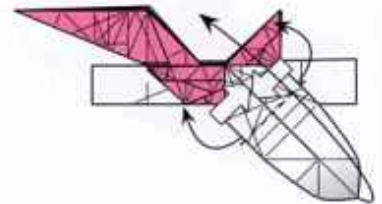

Open the layers  
and flatten along the creases.  
打开纸层并沿峰谷压平

127

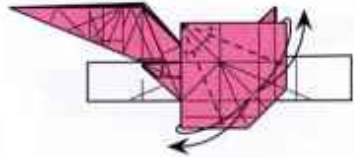

128

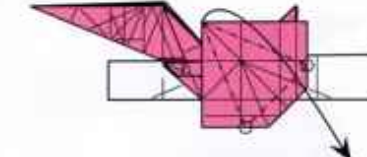

Petal-fold.  
花瓣折

129

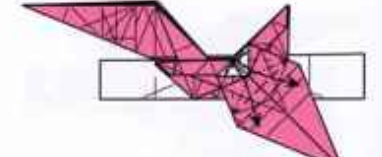

Swivel-folds.  
旋转折

118

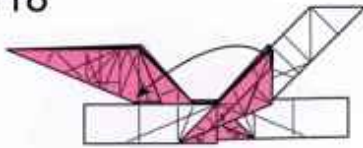

119

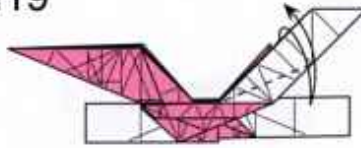

120



Crimp.  
双向段折

121

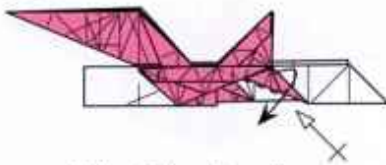

Valley-fold one layer down.  
Repeat behind.  
向下谷折一层，后侧重复

122

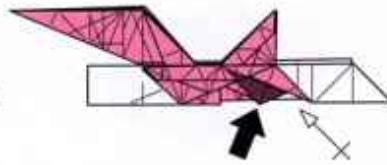

Closed sink. Repeat behind.  
闭合沉折，后侧重复

123

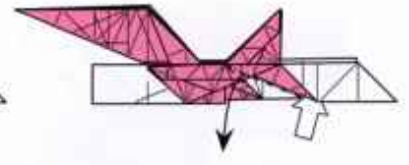

Squash fold. The model will not stay flat.  
撑开纸层，模型无法压平

124

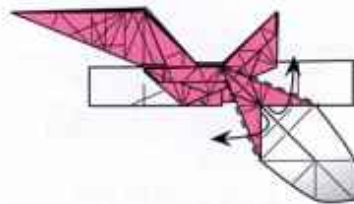

125

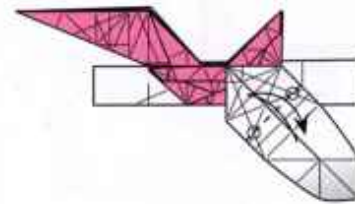

126

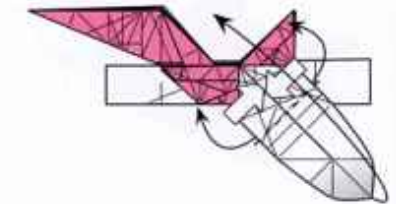

Open the layers  
and flatten along the creases.  
打开纸层并沿峰谷压平

127

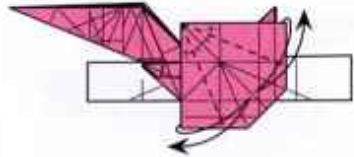

128

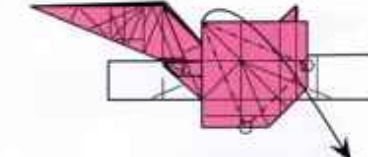

Petal-fold.  
花瓣折

129

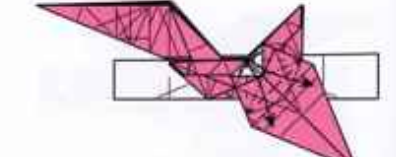

Swivel-folds.  
旋转折

118

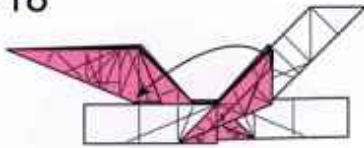

119

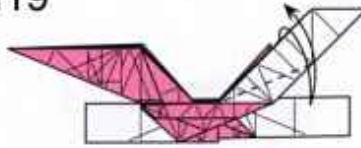

120

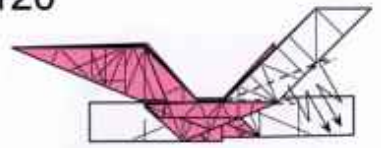

Crimp.  
双向段折

121

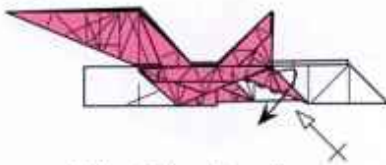

Valley-fold one layer down.  
Repeat behind.  
向下谷折一层，后侧重复

122

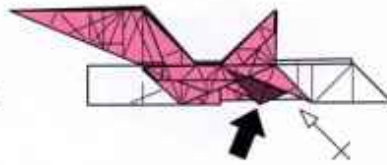

Closed sink. Repeat behind.  
闭合沉折，后侧重复

123

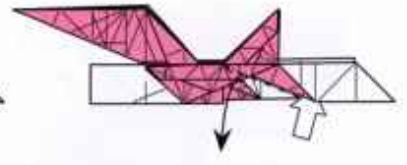

Squash fold. The model will not stay flat.  
撑开纸层，模型无法压平

124

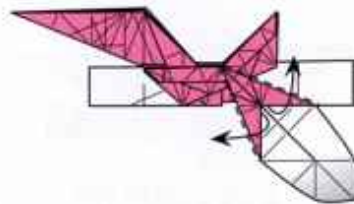

125

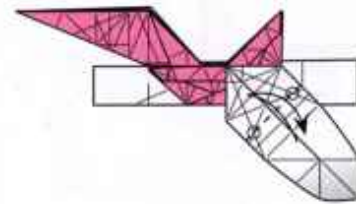

126

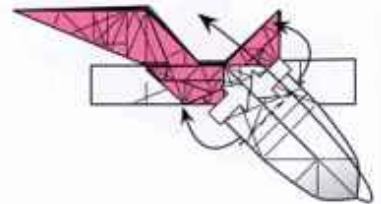

Open the layers  
and flatten along the creases.  
打开纸层并沿峰谷压平

127

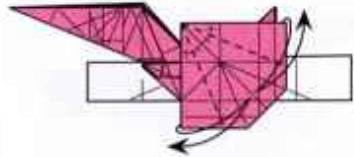

128

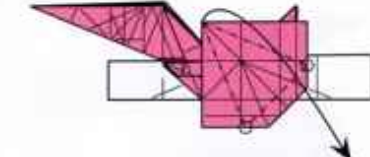

Petal-fold.  
花瓣折

129

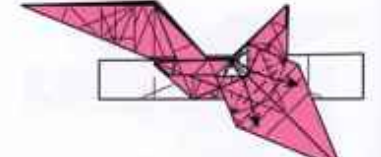

Swivel-folds.  
旋转折



118

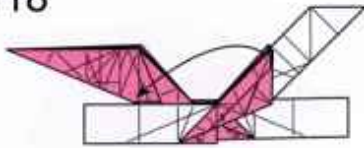

119

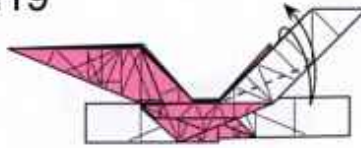

120

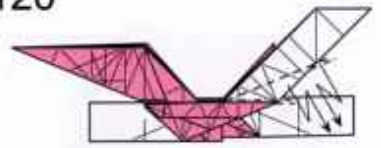

Crimp.  
双向段折

121

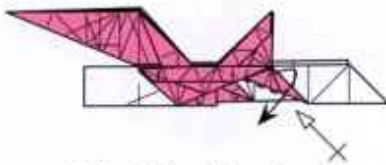

Valley-fold one layer down.  
Repeat behind.  
向下谷折一层，后侧重复

122

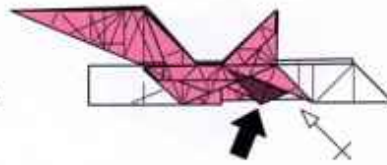

Closed sink. Repeat behind.  
闭合沉折，后侧重复

123

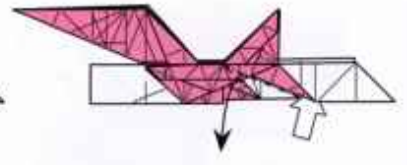

Squash fold. The model will not stay flat.  
撑开纸层，模型无法压平

124

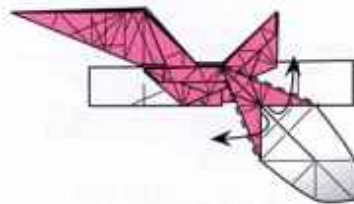

125

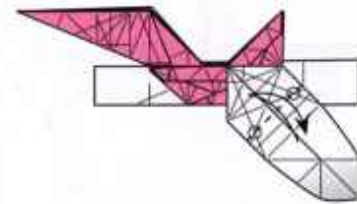

126

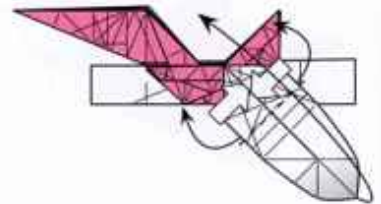

Open the layers  
and flatten along the creases.  
打开纸层并沿峰谷压平

127

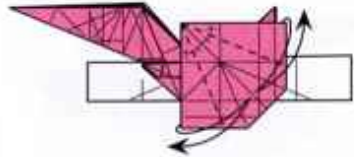

128

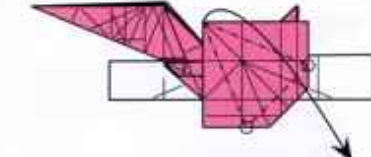

Petal-fold.  
花瓣折

129

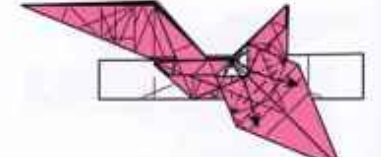

Swivel-folds.  
旋转折

118

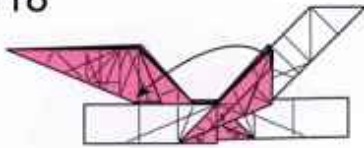

119

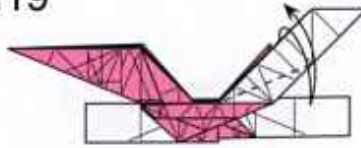

120

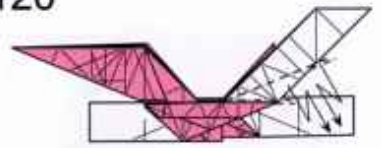

Crimp.  
双向段折

121

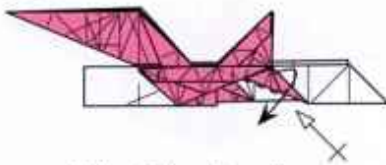

Valley-fold one layer down.  
Repeat behind.  
向下谷折一层，后侧重复

122

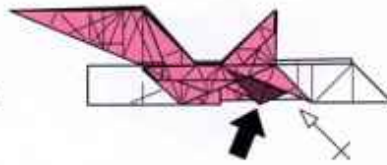

Closed sink. Repeat behind.  
闭合沉折，后侧重复

123

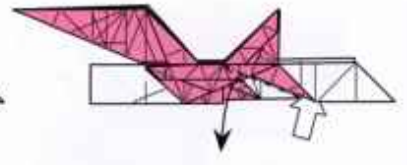

Squash fold. The model will not stay flat.  
撑开纸层，模型无法压平

124

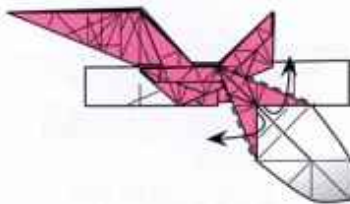

125

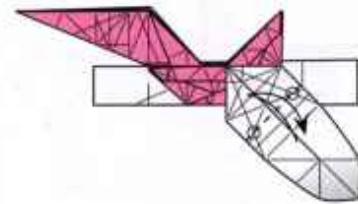

126

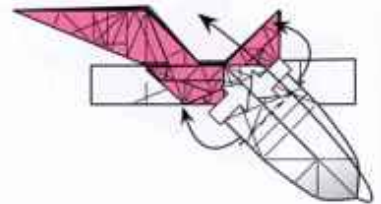

Open the layers  
and flatten along the creases.  
打开纸层并沿峰谷压平

127

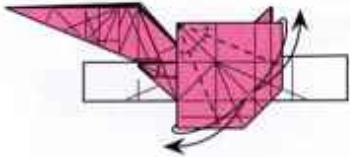

128

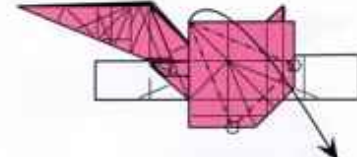

Petal-fold.  
花瓣折

129

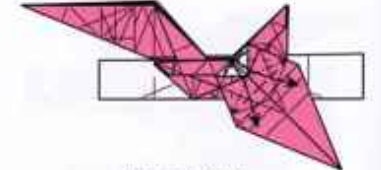

Swivel-folds.  
旋转折

118

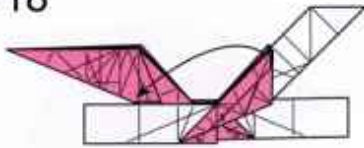

119

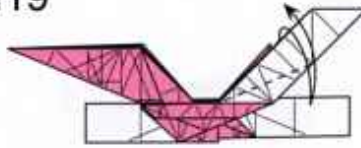

120

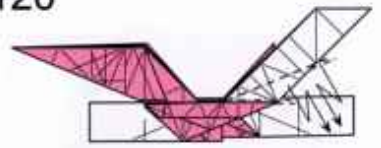

Crimp.  
双向段折

121

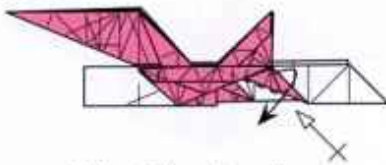

Valley-fold one layer down.  
Repeat behind.  
向下谷折一层，后侧重复

122

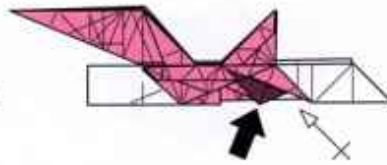

Closed sink. Repeat behind.  
闭合沉折，后侧重复

123

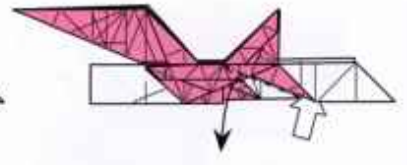

Squash fold. The model will not stay flat.  
撑开纸层，模型无法压平

124

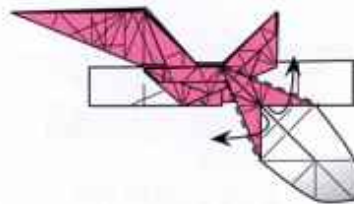

125

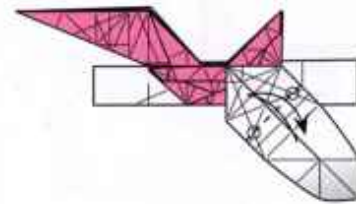

126

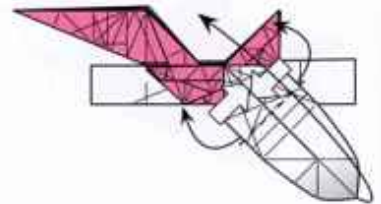

Open the layers  
and flatten along the creases.  
打开纸层并沿峰谷压平

127

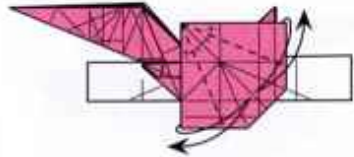

128

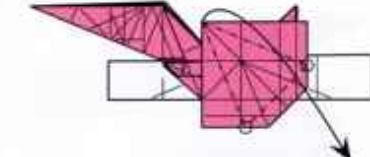

Petal-fold.  
花瓣折

129

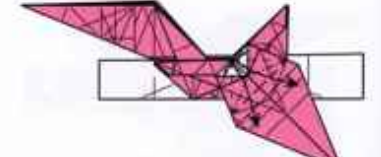

Swivel-folds.  
旋转折

118

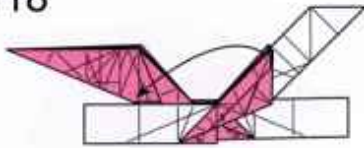

119

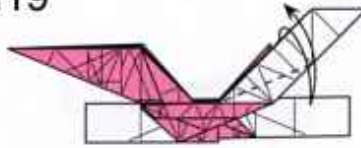

120

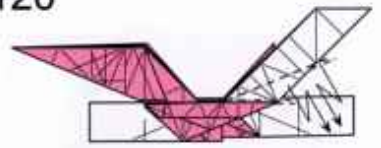

Crimp.  
双向段折

121

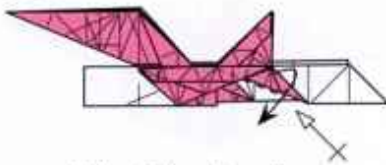

Valley-fold one layer down.  
Repeat behind.  
向下谷折一层，后侧重复

122

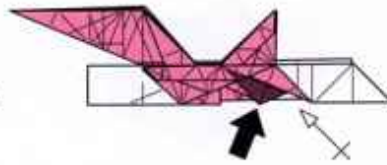

Closed sink. Repeat behind.  
闭合沉折，后侧重复

123

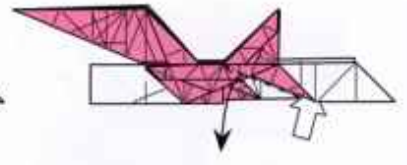

Squash fold. The model will not stay flat.  
撑开纸层，模型无法压平

124

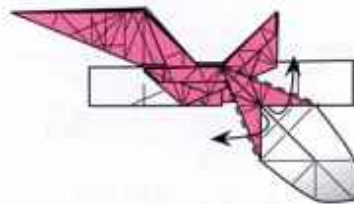

125

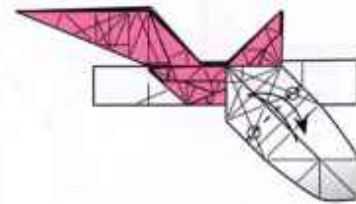

126

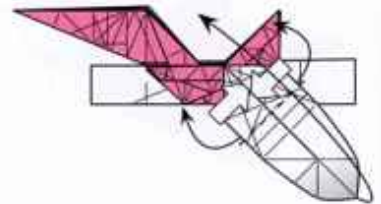

Open the layers  
and flatten along the creases.  
打开纸层并沿峰谷压平

127

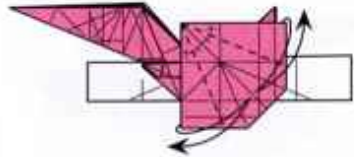

128

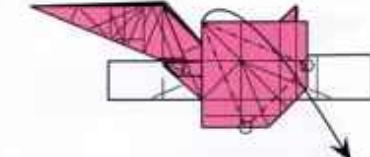

Petal-fold.  
花瓣折

129

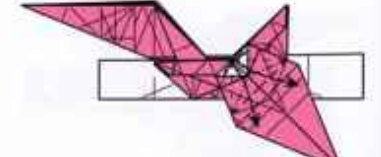

Swivel-folds.  
旋转折

118

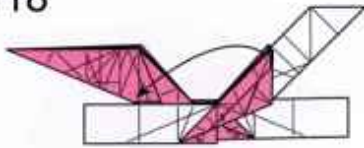

119

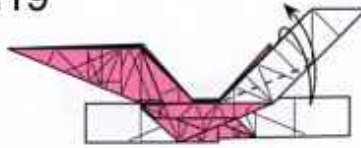

120

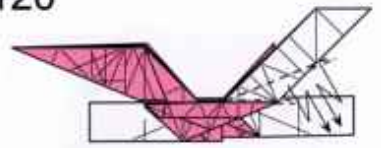

Crimp.  
双向段折

121

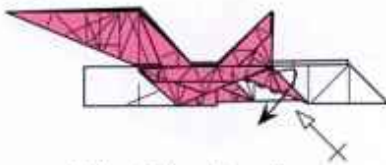

Valley-fold one layer down.  
Repeat behind.  
向下谷折一层，后侧重复

122

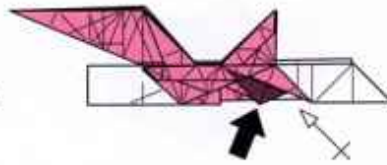

Closed sink. Repeat behind.  
闭合沉折，后侧重复

123

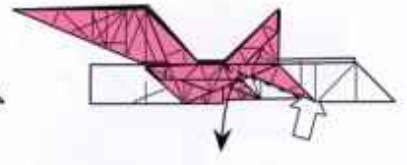

Squash fold. The model will not stay flat.  
撑开纸层，模型无法压平

124

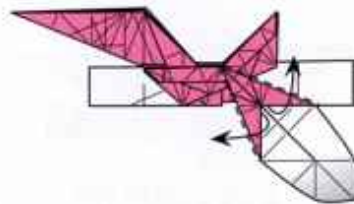

125

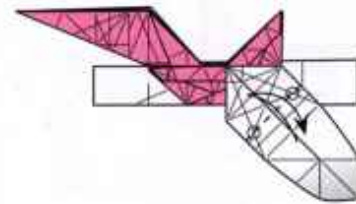

126

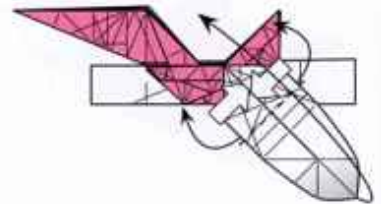

Open the layers  
and flatten along the creases.  
打开纸层并沿峰谷压平

127

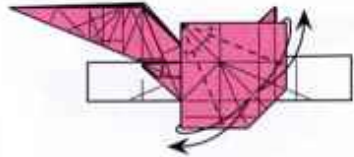

128

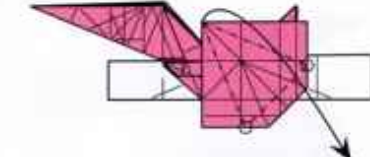

Petal-fold.  
花瓣折

129

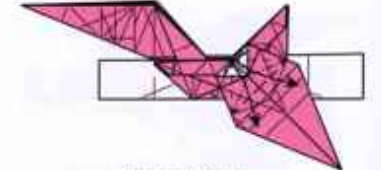

Swivel-folds.  
旋转折

118

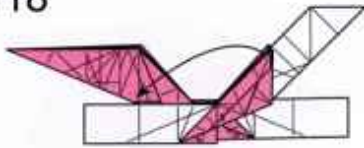

119

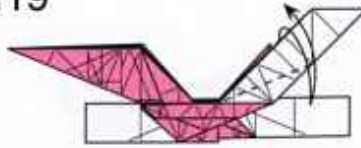

120

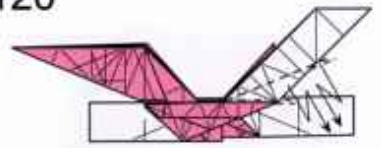

Crimp.  
双向段折

121

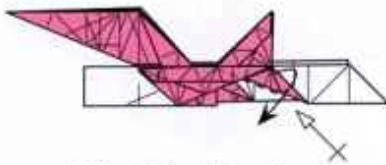

Valley-fold one layer down.  
Repeat behind.  
向下谷折一层，后侧重复

122

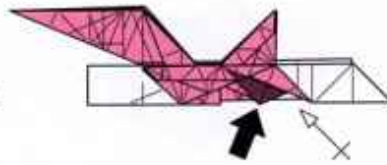

Closed sink. Repeat behind.  
闭合沉折，后侧重复

123

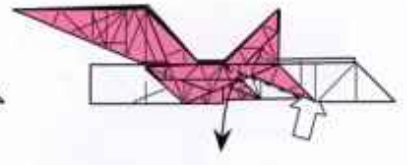

Squash fold. The model will not stay flat.  
撑开纸层，模型无法压平

124

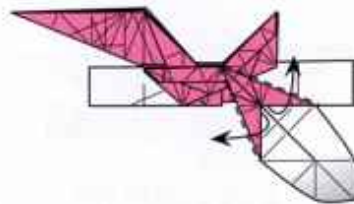

125

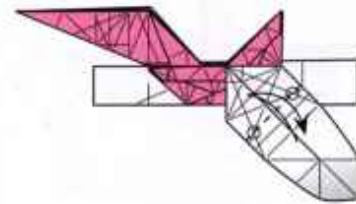

126

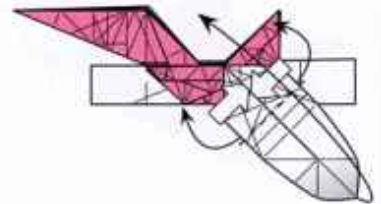

Open the layers  
and flatten along the creases.  
打开纸层并沿峰谷压平

127

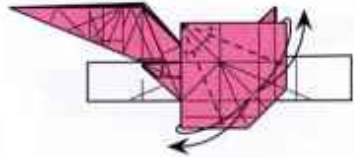

128

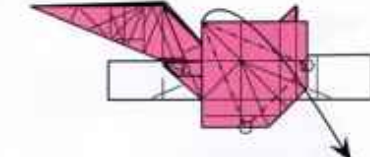

Petal-fold.  
花瓣折

129

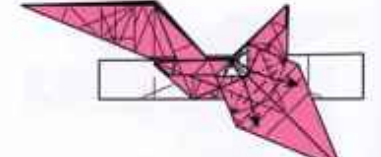

Swivel-folds.  
旋转折

118

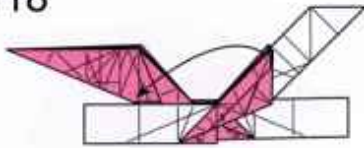

119

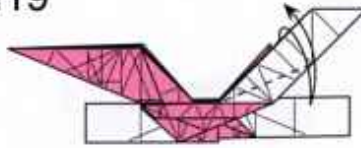

120

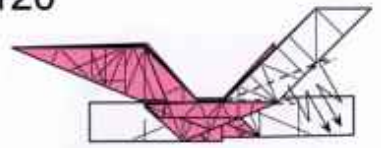

Crimp.  
双向段折

121

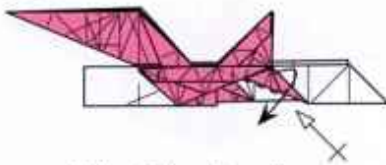

Valley-fold one layer down.  
Repeat behind.  
向下谷折一层，后侧重复

122

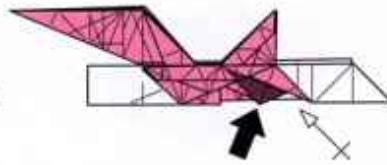

Closed sink. Repeat behind.  
闭合沉折，后侧重复

123

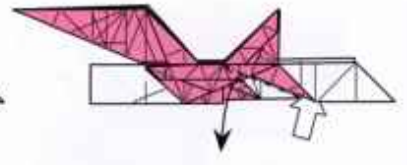

Squash fold. The model will not stay flat.  
撑开纸层，模型无法压平

124

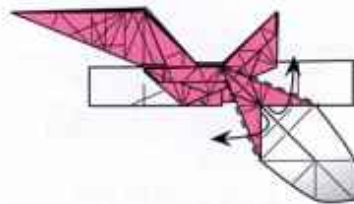

125

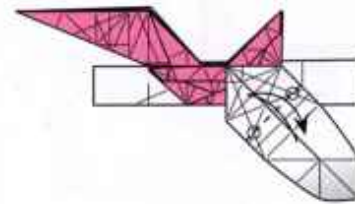

126

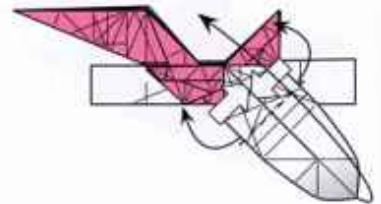

Open the layers  
and flatten along the creases.  
打开纸层并沿峰谷压平

127

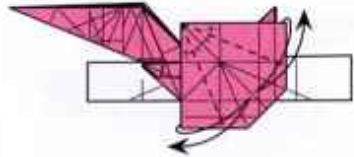

128

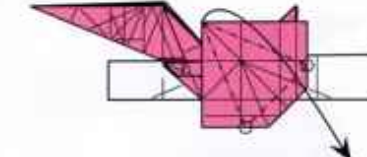

Petal-fold.  
花瓣折

129

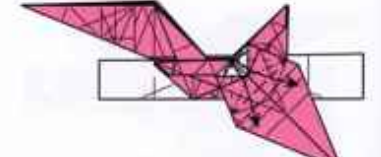

Swivel-folds.  
旋转折

118

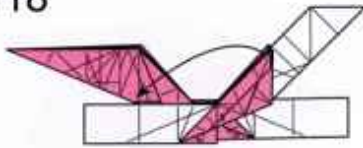

119

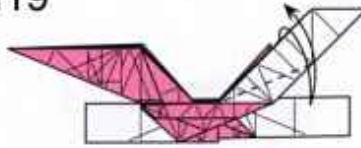

120

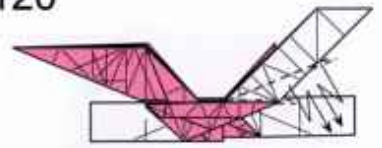

Crimp.  
双向段折

121

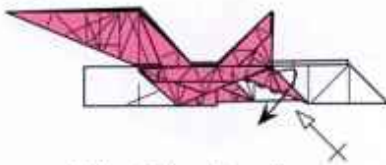

Valley-fold one layer down.  
Repeat behind.  
向下谷折一层，后侧重复

122

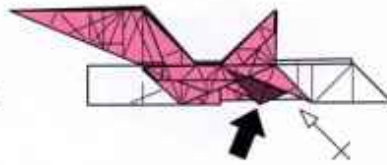

Closed sink. Repeat behind.  
闭合沉折，后侧重复

123

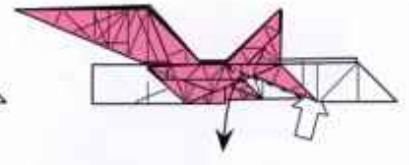

Squash fold. The model will not stay flat.  
撑开纸层，模型无法压平

124

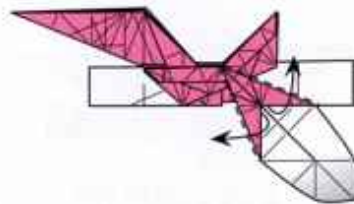

125

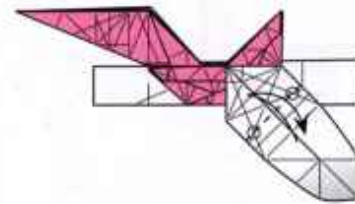

126

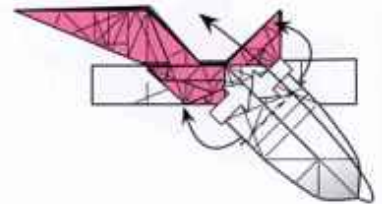

Open the layers  
and flatten along the creases.  
打开纸层并沿峰谷压平

127

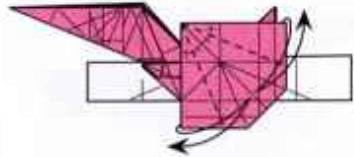

128

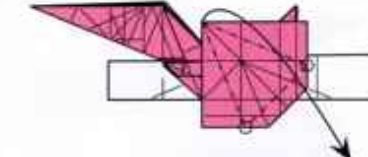

Petal-fold.  
花瓣折

129

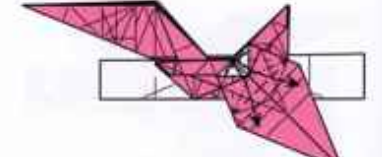

Swivel-folds.  
旋转折



118

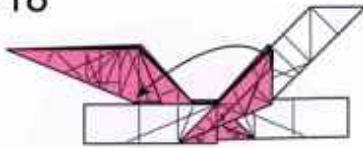

119

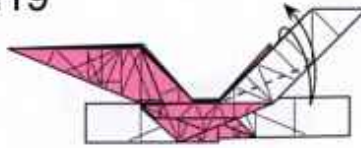

120



Crimp.  
双向段折

121

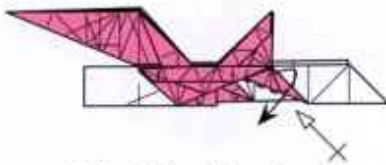

Valley-fold one layer down.  
Repeat behind.  
向下谷折一层，后侧重复

122

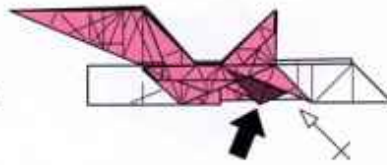

Closed sink. Repeat behind.  
闭合沉折，后侧重复

123

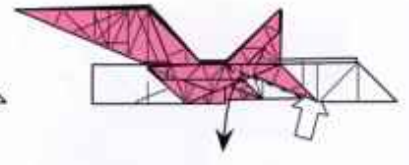

Squash fold. The model will not stay flat.  
撑开纸层，模型无法压平

124

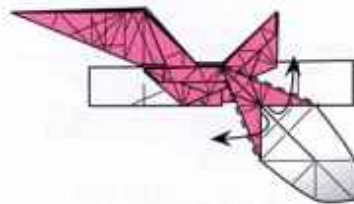

125

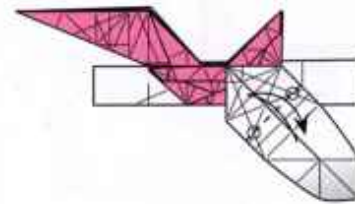

126

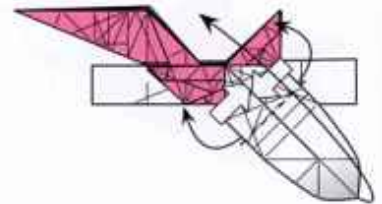

Open the layers  
and flatten along the creases.  
打开纸层并沿峰谷压平

127

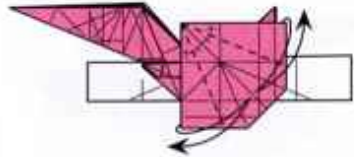

128

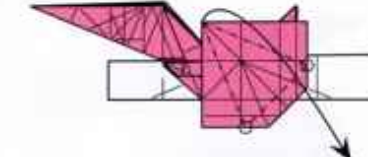

Petal-fold.  
花瓣折

129

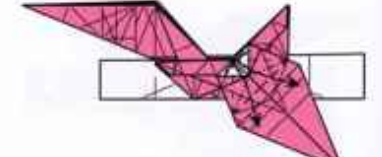

Swivel-folds.  
旋转折

118

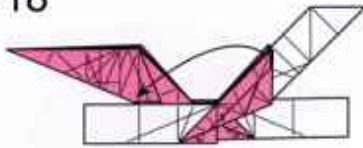

119

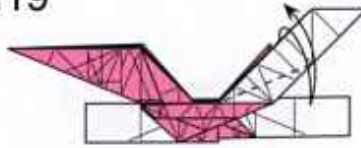

120

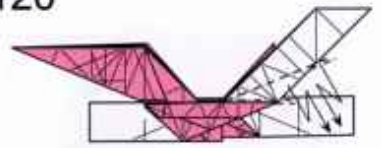

Crimp.  
双向段折

121

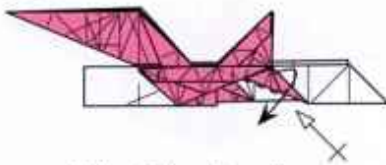

Valley-fold one layer down.  
Repeat behind.  
向下谷折一层，后侧重复

122

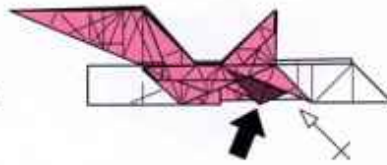

Closed sink. Repeat behind.  
闭合沉折，后侧重复

123

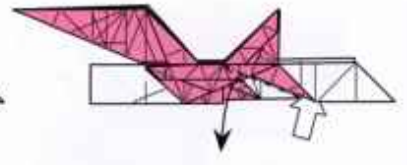

Squash fold. The model will not stay flat.  
撑开纸层，模型无法压平

124

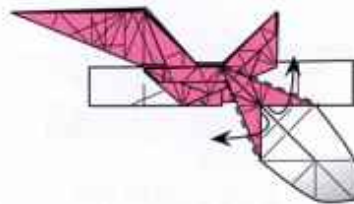

125

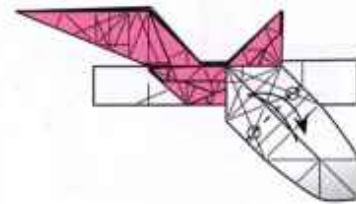

126

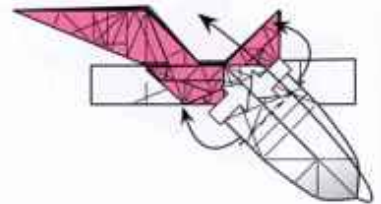

Open the layers  
and flatten along the creases.  
打开纸层并沿峰谷压平

127

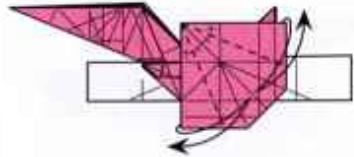

128

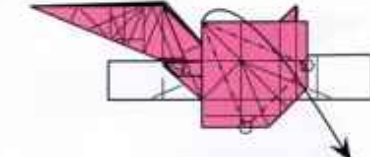

Petal-fold.  
花瓣折

129

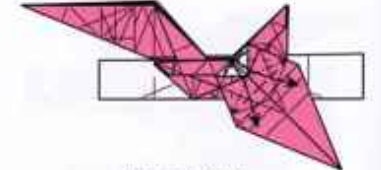

Swivel-folds.  
旋转折

118

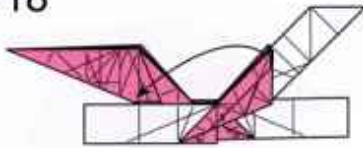

119

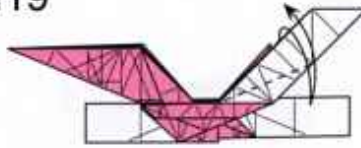

120

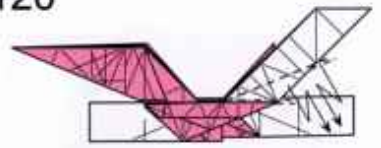

Crimp.  
双向段折

121

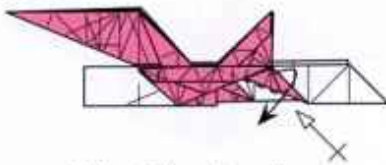

Valley-fold one layer down.  
Repeat behind.  
向下谷折一层，后侧重复

122

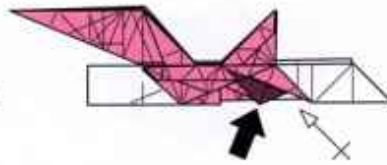

Closed sink. Repeat behind.  
闭合沉折，后侧重复

123

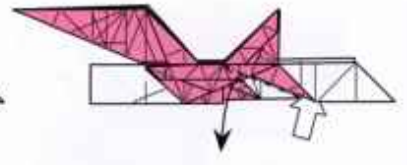

Squash fold. The model will not stay flat.  
撑开纸层，模型无法压平

124

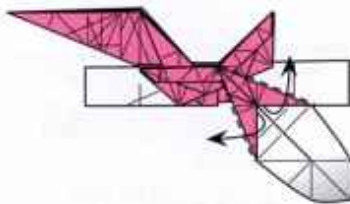

125

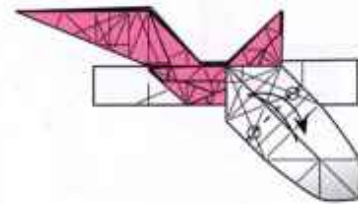

126

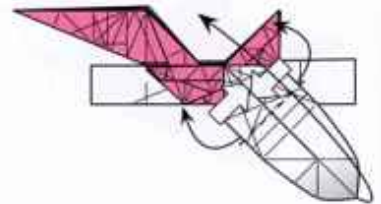

Open the layers  
and flatten along the creases.  
打开纸层并沿峰谷压平

127

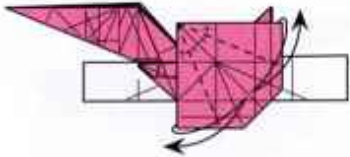

128

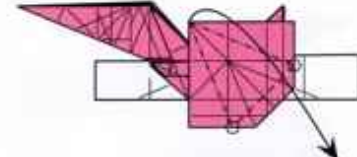

Petal-fold.  
花瓣折

129

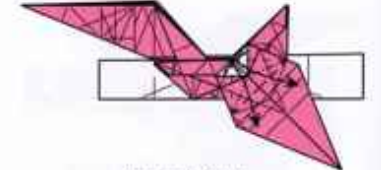

Swivel-folds.  
旋转折

118

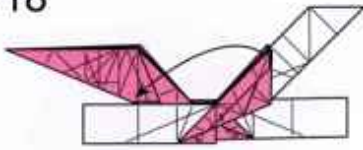

119

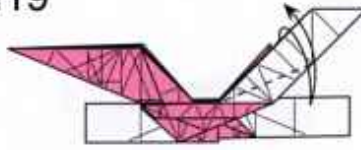

120

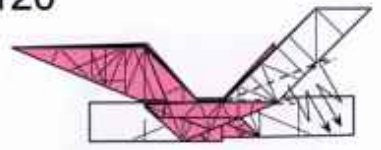

Crimp.  
双向段折

121

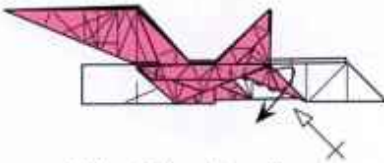

Valley-fold one layer down.  
Repeat behind.  
向下谷折一层，后侧重复

122

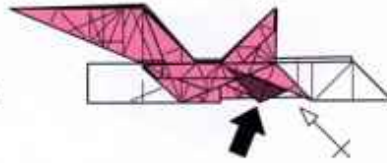

Closed sink. Repeat behind.  
闭合沉折，后侧重复

123

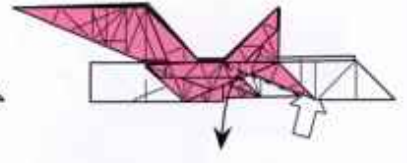

Squash fold. The model will not stay flat.  
撑开纸层，模型无法压平

124

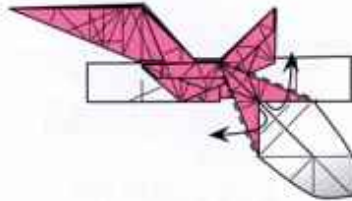

125

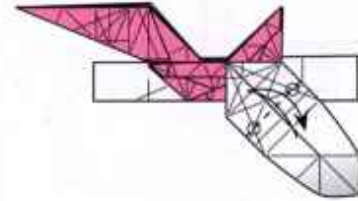

126

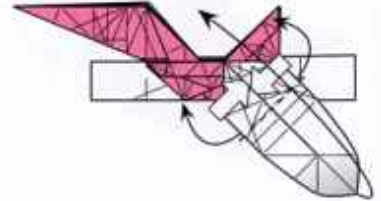

Open the layers  
and flatten along the creases.  
打开纸层并沿峰谷压平

127

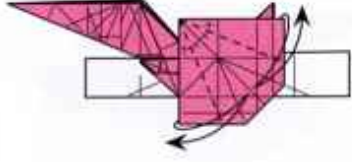

128

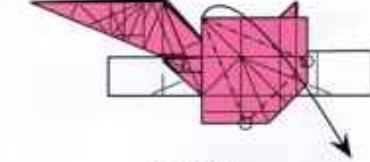

Petal-fold.  
花瓣折

129

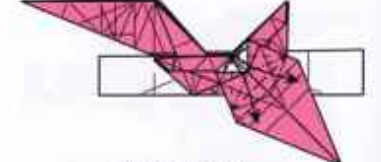

Swivel-folds.  
旋转折

118

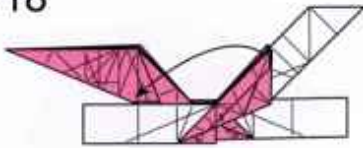

119

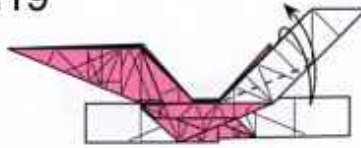

120

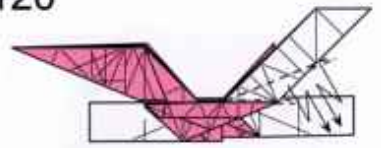

Crimp.  
双向段折

121

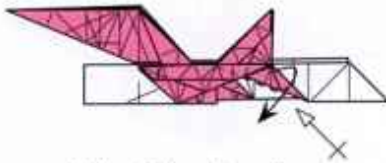

Valley-fold one layer down.  
Repeat behind.  
向下谷折一层，后侧重复

122

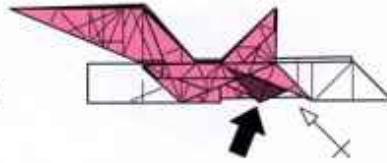

Closed sink. Repeat behind.  
闭合沉折，后侧重复

123

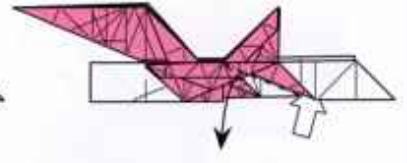

Squash fold. The model will not stay flat.  
撑开纸层，模型无法压平

124

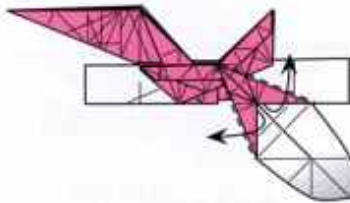

125

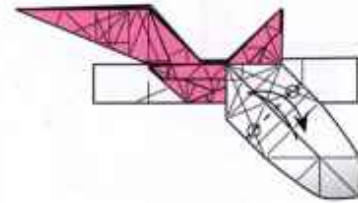

126

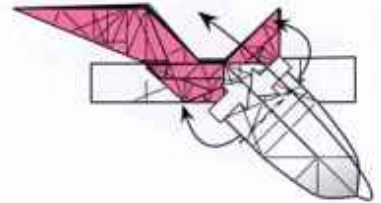

Open the layers  
and flatten along the creases.  
打开纸层并沿峰谷压平

127

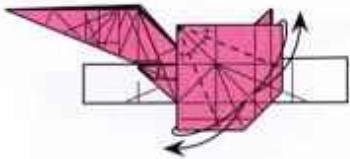

128

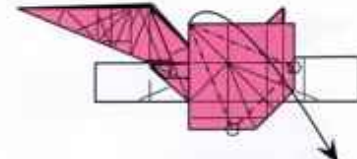

Petal-fold.  
花瓣折

129

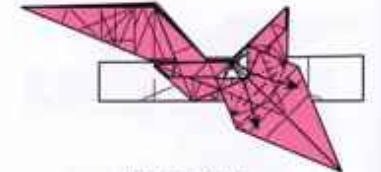

Swivel-folds.  
旋转折

118

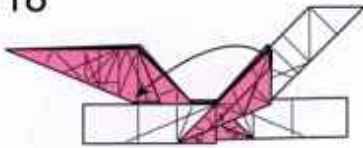

119

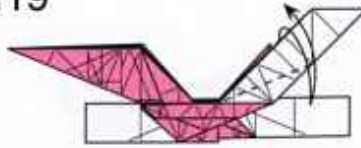

120

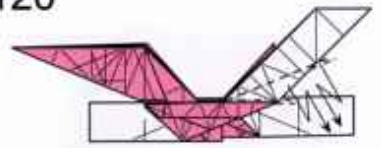

Crimp.  
双向段折

121

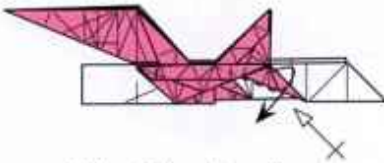

Valley-fold one layer down.  
Repeat behind.  
向下谷折一层，后侧重复

122

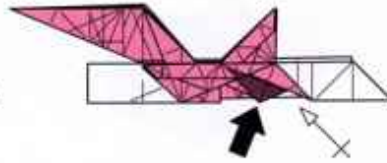

Closed sink. Repeat behind.  
闭合沉折，后侧重复

123

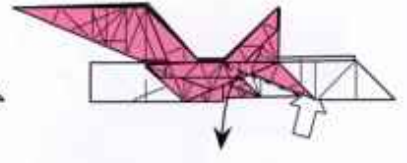

Squash fold. The model will not stay flat.  
撑开纸层，模型无法压平

124

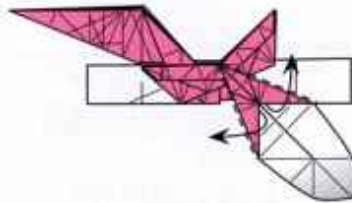

125

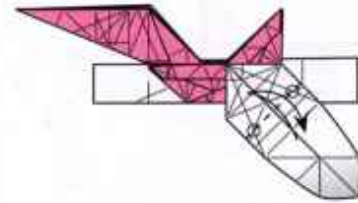

126

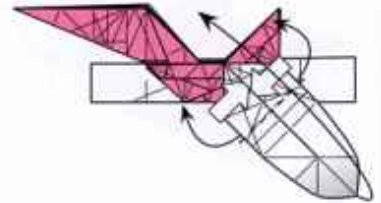

Open the layers  
and flatten along the creases.  
打开纸层并沿峰谷压平

127

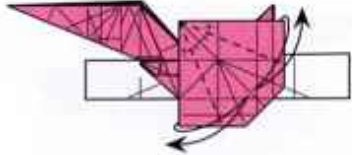

128

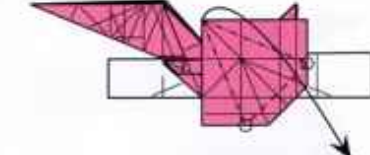

Petal-fold.  
花瓣折

129

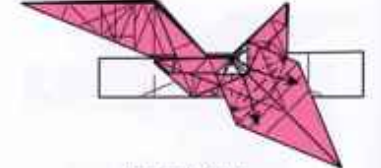

Swivel-folds.  
旋转折

118

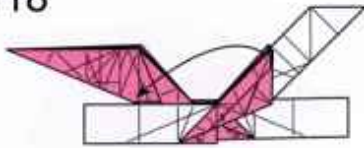

119

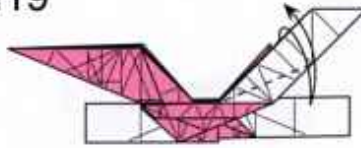

120

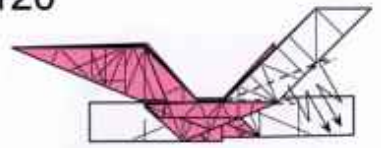

Crimp.  
双向段折

121

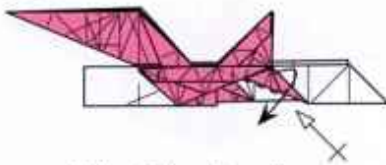

Valley-fold one layer down.  
Repeat behind.  
向下谷折一层，后侧重复

122

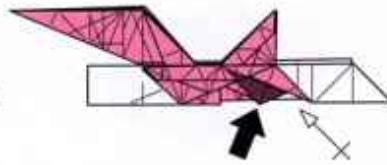

Closed sink. Repeat behind.  
闭合沉折，后侧重复

123

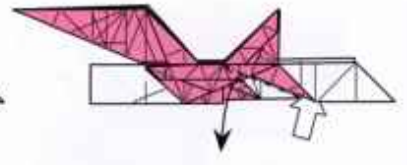

Squash fold. The model will not stay flat.  
撑开纸层，模型无法压平

124

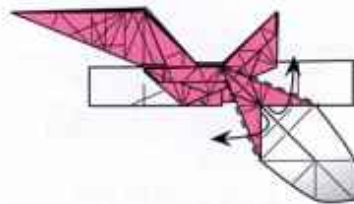

125

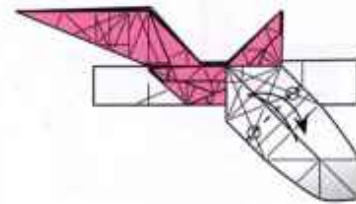

126

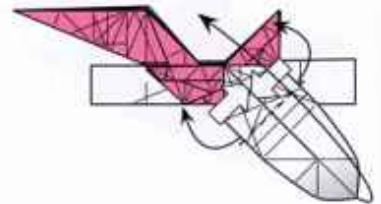

Open the layers  
and flatten along the creases.  
打开纸层并沿峰谷压平

127

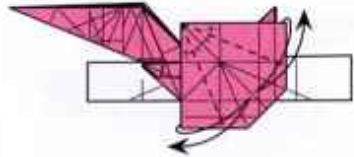

128

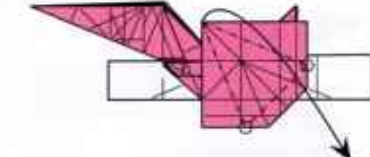

Petal-fold.  
花瓣折

129

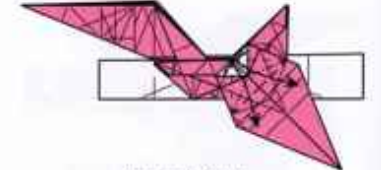

Swivel-folds.  
旋转折

118

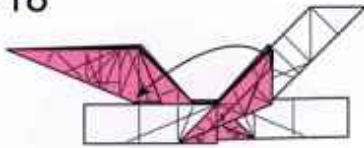

119

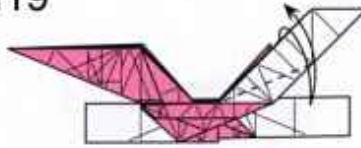

120

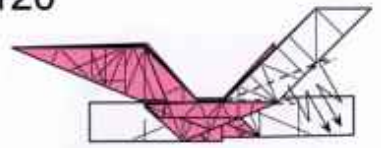

Crimp.  
双向段折

121

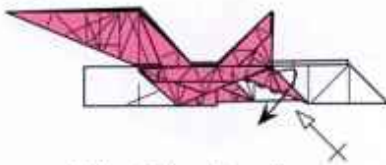

Valley-fold one layer down.  
Repeat behind.  
向下谷折一层，后侧重复

122

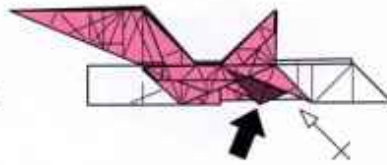

Closed sink. Repeat behind.  
闭合沉折，后侧重复

123

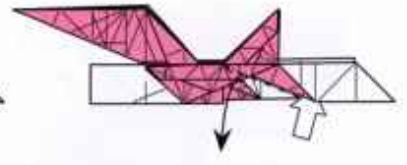

Squash fold. The model will not stay flat.  
撑开纸层，模型无法压平

124

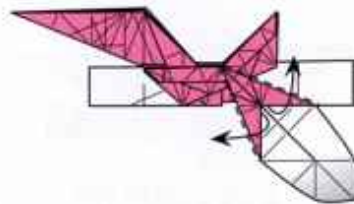

125

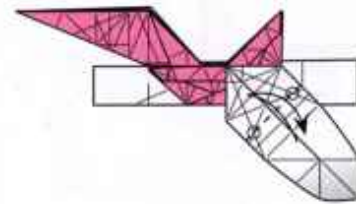

126

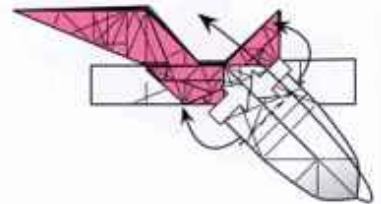

Open the layers  
and flatten along the creases.  
打开纸层并沿峰谷压平

127

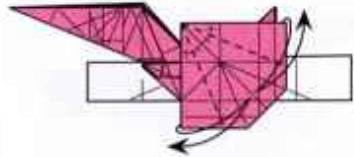

128

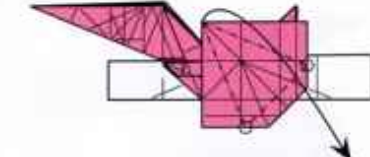

Petal-fold.  
花瓣折

129

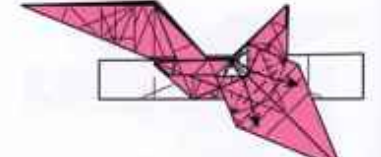

Swivel-folds.  
旋转折



118

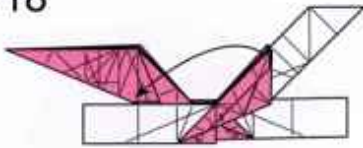

119

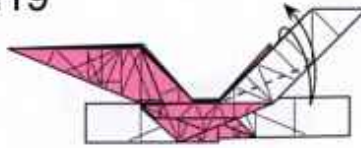

120

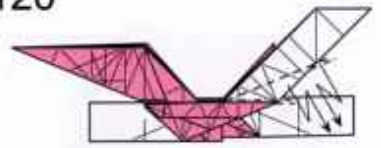

Crimp.  
双向段折

121

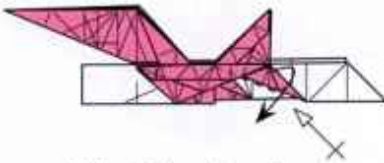

Valley-fold one layer down.  
Repeat behind.  
向下谷折一层，后侧重复

122

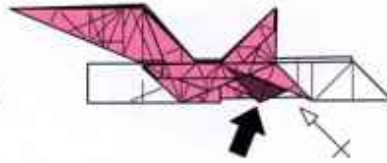

Closed sink. Repeat behind.  
闭合沉折，后侧重复

123

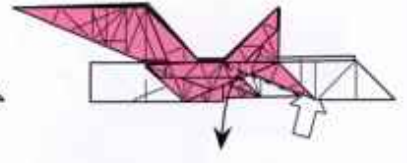

Squash fold. The model will not stay flat.  
撑开纸层，模型无法压平

124

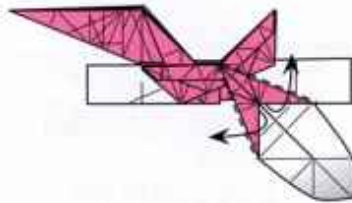

125

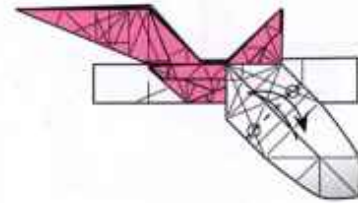

126

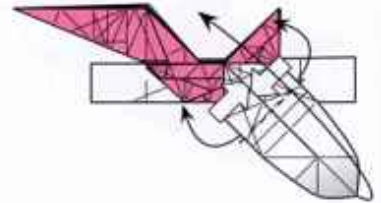

Open the layers  
and flatten along the creases.  
打开纸层并沿峰谷压平

127

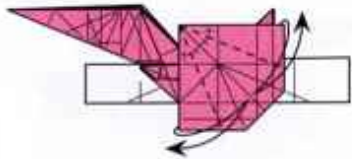

128

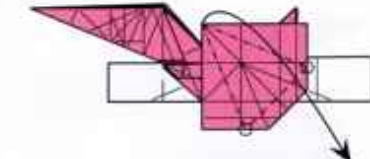

Petal-fold.  
花瓣折

129

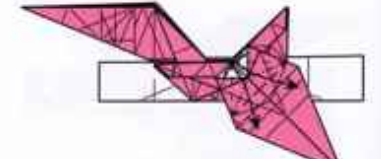

Swivel-folds.  
旋转折

118

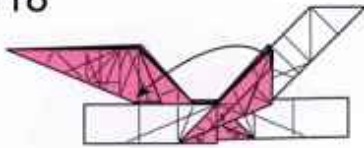

119

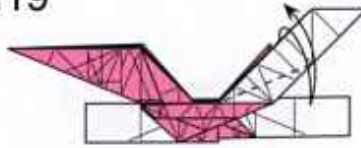

120

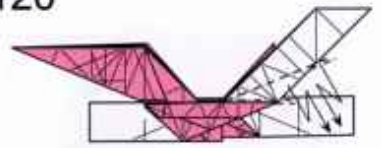

Crimp.  
双向段折

121

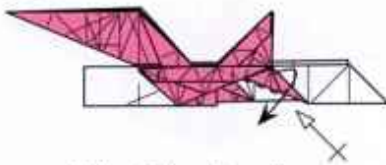

Valley-fold one layer down.  
Repeat behind.  
向下谷折一层，后侧重复

122

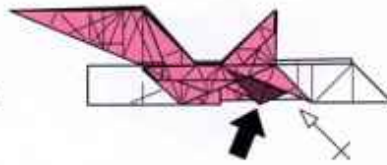

Closed sink. Repeat behind.  
闭合沉折，后侧重复

123

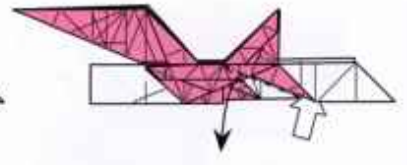

Squash fold. The model will not stay flat.  
撑开纸层，模型无法压平

124

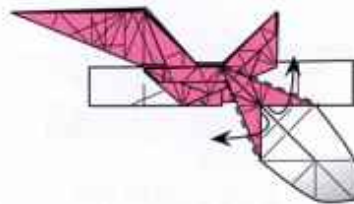

125

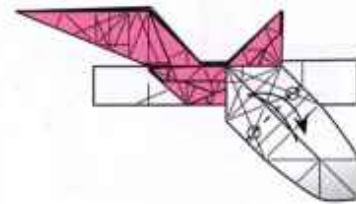

126

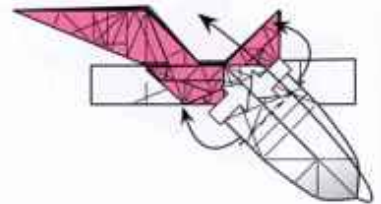

Open the layers  
and flatten along the creases.  
打开纸层并沿峰谷压平

127

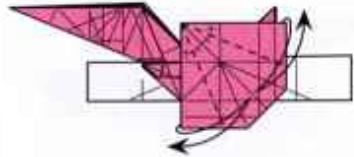

128

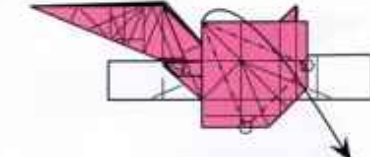

Petal-fold.  
花瓣折

129

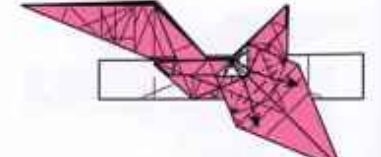

Swivel-folds.  
旋转折

118

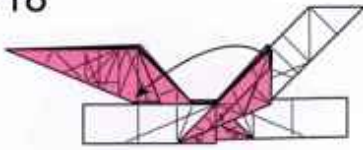

119

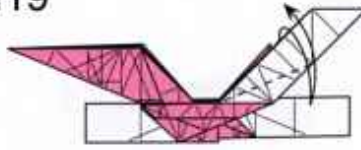

120

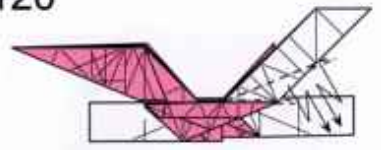

Crimp.  
双向段折

121

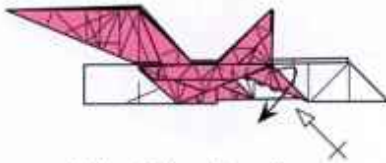

Valley-fold one layer down.  
Repeat behind.  
向下谷折一层，后侧重复

122

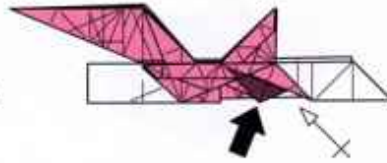

Closed sink. Repeat behind.  
闭合沉折，后侧重复

123

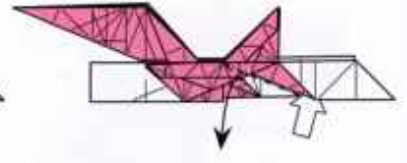

Squash fold. The model will not stay flat.  
撑开纸层，模型无法压平

124

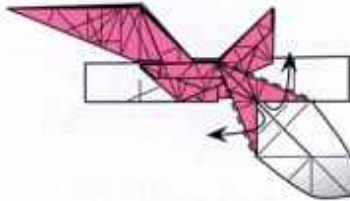

125

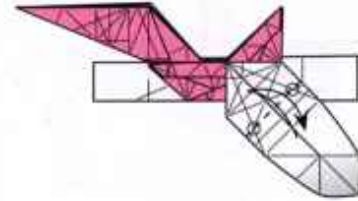

126

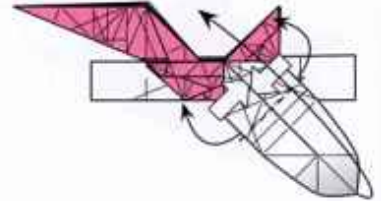

Open the layers  
and flatten along the creases.  
打开纸层并沿峰谷压平

127

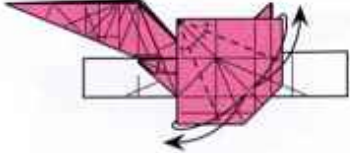

128

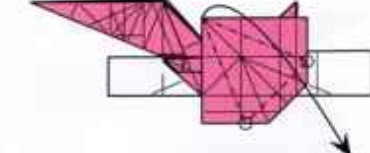

Petal-fold.  
花瓣折

129

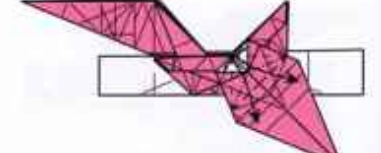

Swivel-folds.  
旋转折

130

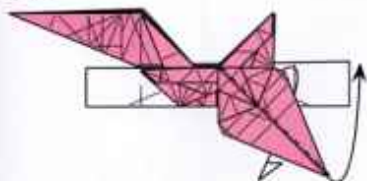

131



132



Open sink.  
开放沉折

133

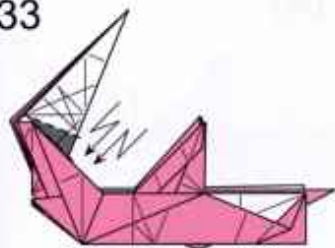

Crimp all layers.  
所有纸层段折

134

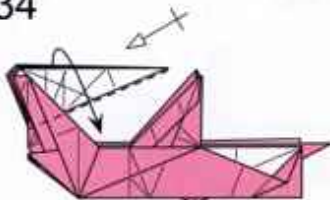

135

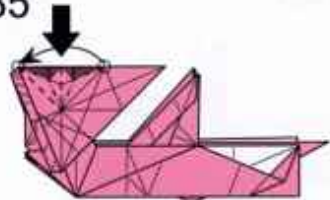

Collapse according to the creases.  
按峰谷聚合

136

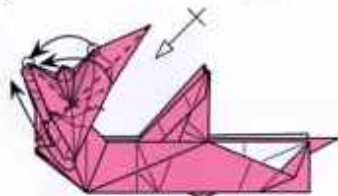

Collapse according to the creases.  
按峰谷聚合

137

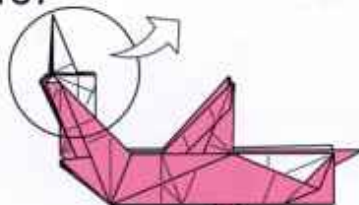

Zoom in.  
局部视图放大

138

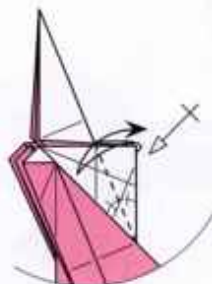

Fold along the angle bisector  
and unfold.Repeat behind.  
沿角平分线留下折痕, 后侧重复

139

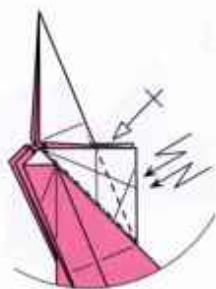

Crimp.Repeat behind.  
双向段折, 后侧重复

140

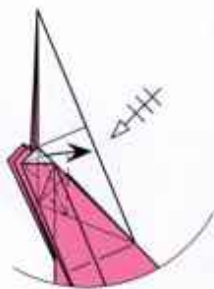

Swivel-fold.  
Repeat on the other three flaps.  
旋转折, 另外三片重复

141



Swivel-fold.Repeat behind.  
旋转折, 后侧重复

142

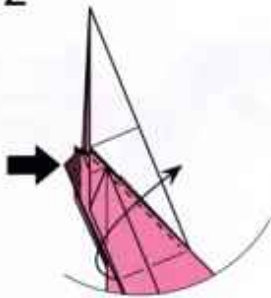

Spread sink.  
延展沉折

143

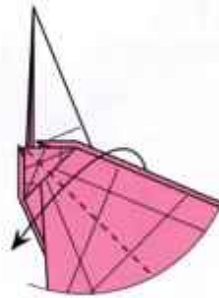

144

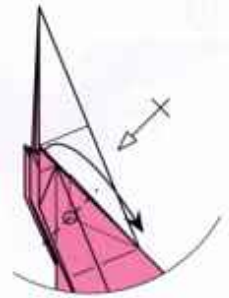

145

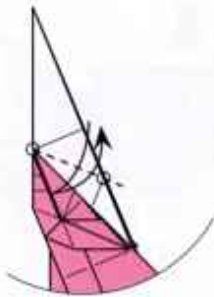

146



Crimp all layers.  
所有纸层段折

147

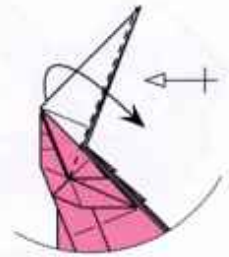

148

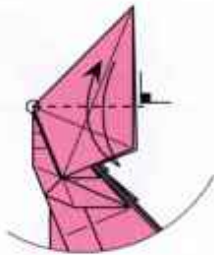

149

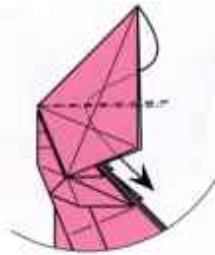

Inside reverse-fold.  
内翻折

150

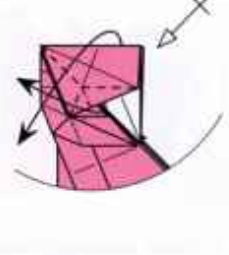

151



Change perspective.  
视角转换

152

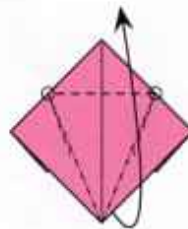

Petal-fold.  
花瓣折

153

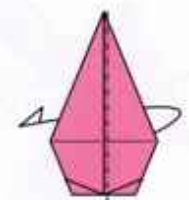

154

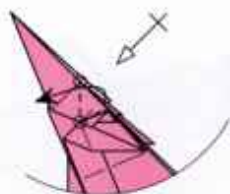

Swivel-fold.Repeat behind.  
旋转折, 后侧重复

155

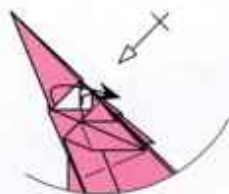

156

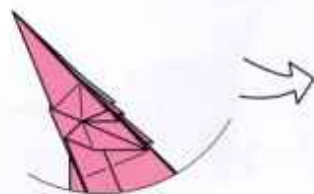

Zoom out.  
视图复原

157

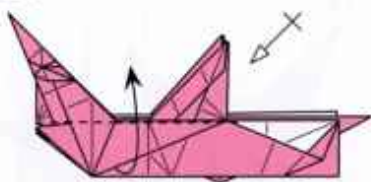

158

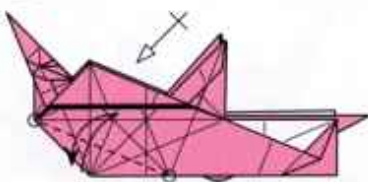

159

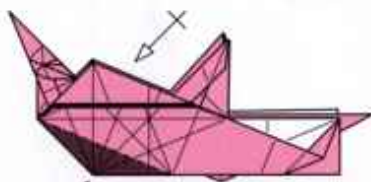

Open sink.Repeat behind.  
开放沉折, 后侧重复

160

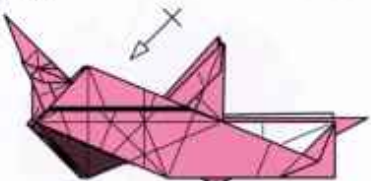

Open sink.Repeat behind.  
开放沉折, 后侧重复

161

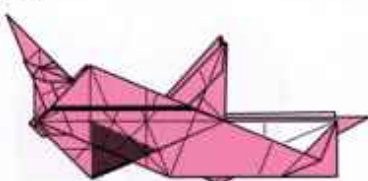

Open sink along the creases.  
沿折痕开放沉折

162

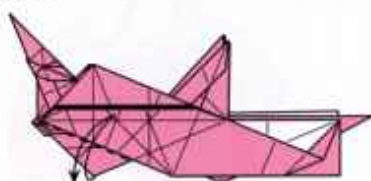

163

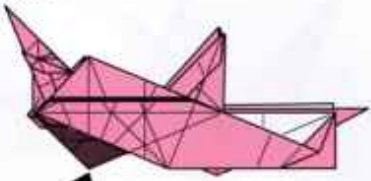

Closed sink.  
闭合沉折

164

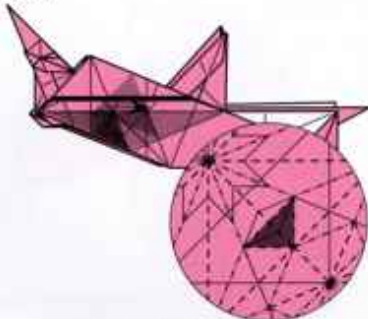

Swivel-fold.  
旋转折

165

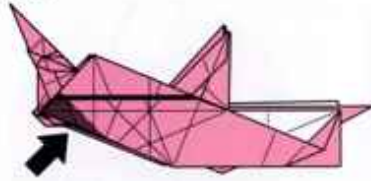

Open sink along the creases.  
沿折痕开放沉折

202

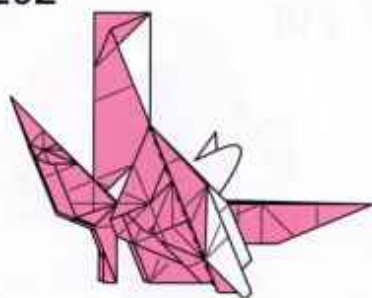

203

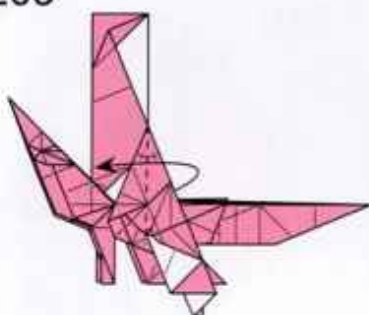

204

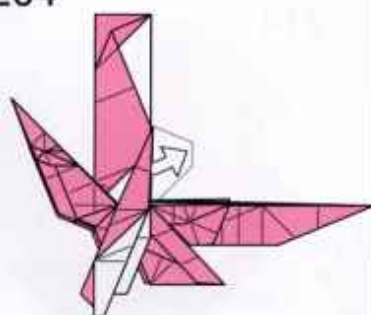

Pull out the hidden layer.  
引出内部纸层

205

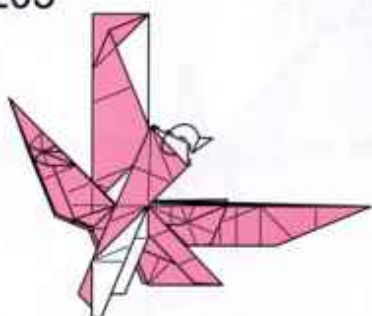

Unwrap to color change.  
翻双色

206

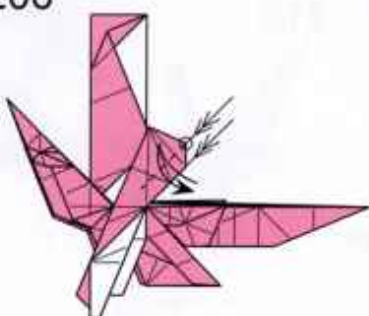

207

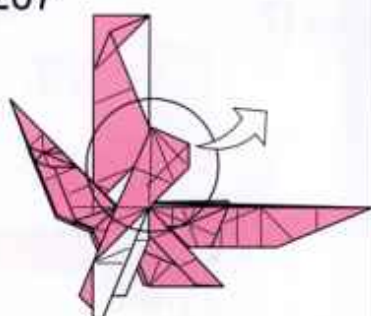

Zoom in.  
局部视图放大

208

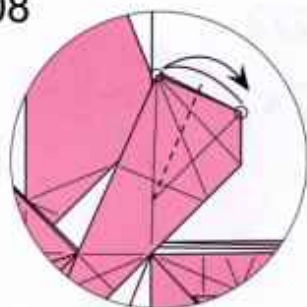

209

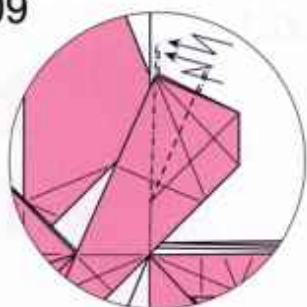

Crimp.  
双向段折

210

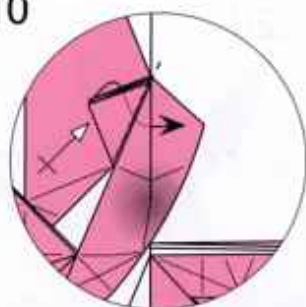

Inside reverse-fold.  
Repeat on the other flap.  
内翻折, 另一片重复

211

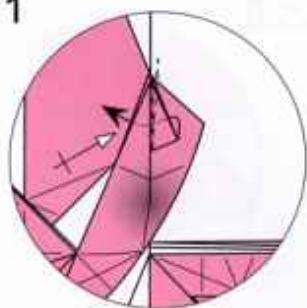

Inside reverse-fold.  
Repeat on the other flap.  
内翻折, 另一片重复

212

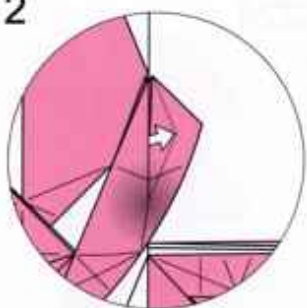

Pull out the hidden layer.  
引出内部纸层

213

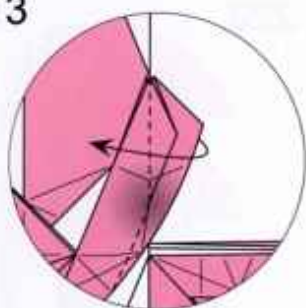

214

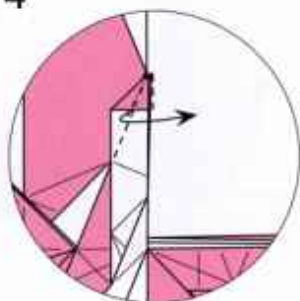

Swivel-fold.  
旋转折

215

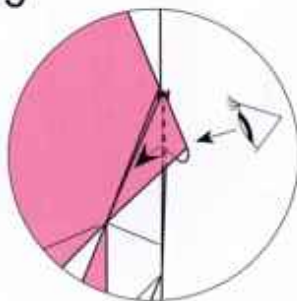

Inside reverse-fold.  
内翻折

216

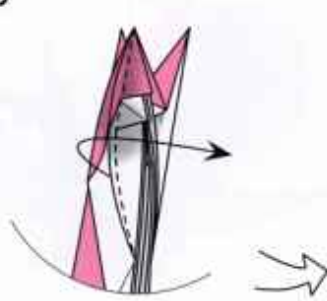

217

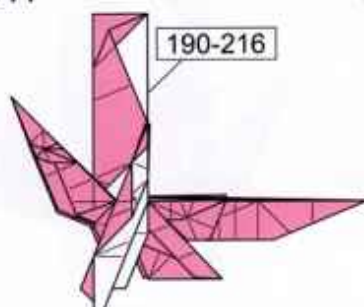

Repeat steps 190 to 216  
on the other side.  
另一侧重复步骤190-216

218

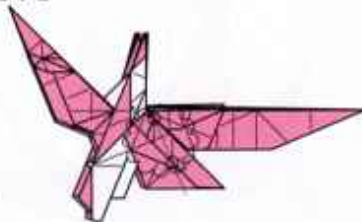

X-ray view.  
透视视角

219

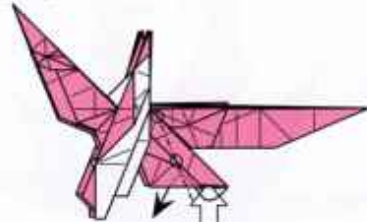

Inside reverse-fold.  
内翻折

220

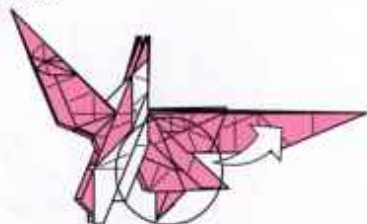

Zoom in.  
局部视图放大

221

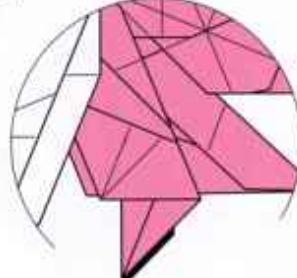

Turn over.  
翻面

222

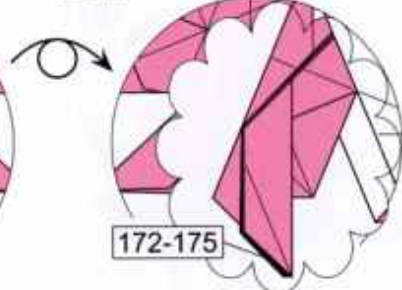

Repeat steps 172 to 175.  
重复步骤10-15

223



224



Inside reverse-fold.  
内翻折

225



Crimp.  
双向段折



226



Repeat steps 223 to 225.  
重复步骤223-225

227



Turn over.  
翻面

228

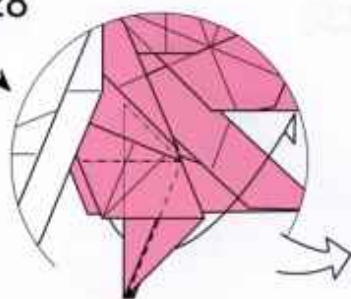

Swivel-fold the layers up.  
旋转折将纸层上拉

229

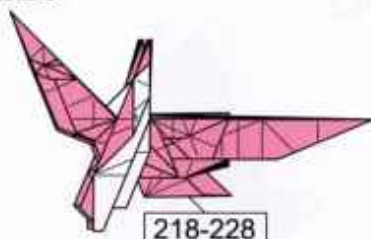

Repeat steps 218 to 228  
on the other side.  
另一侧重复步骤218-228

230

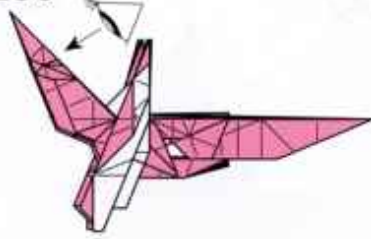

Change perspective.  
视角转换

231

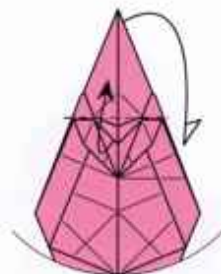

232

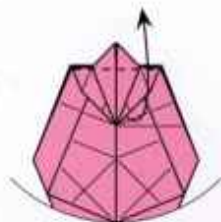

233



234

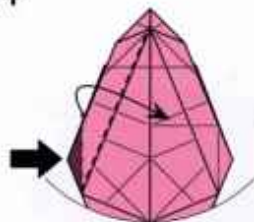

Spread sink. The model will not stay flat.  
延展沉折，模型无法压平

235



Swivel-fold to flatten the model.  
旋转折压平模型

236

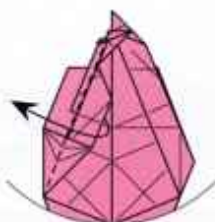

237



Pull out the hidden layer.  
引出内部纸层

238



Closed sink.  
闭合沉折

239

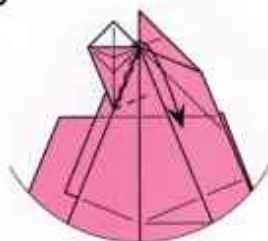

Swivel-fold.  
旋转折

240

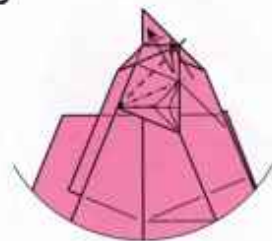

Pleat-fold.  
段折

241

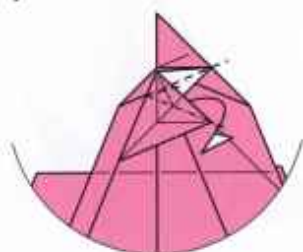

Swivel-fold.  
旋转折

242

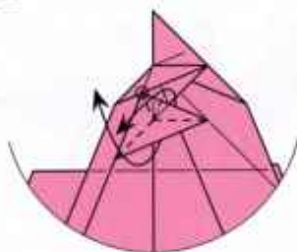

243

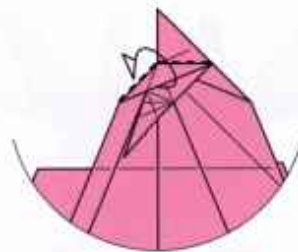

Unwrap.  
翻出纸层

244

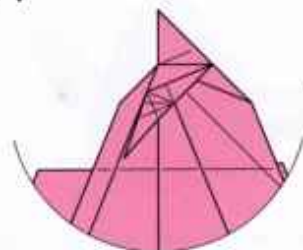

Turn over.  
翻面

245

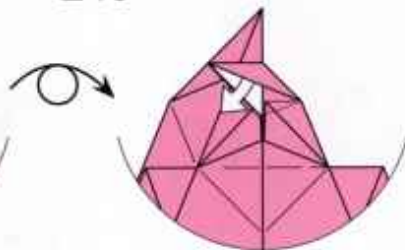

Pull out the hidden layer.  
引出内部纸层

246

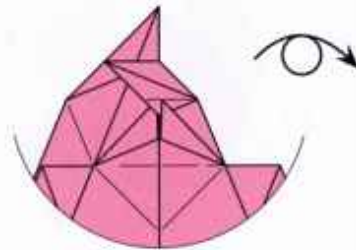

Turn over.  
翻面

247

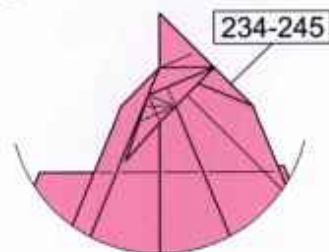

Repeat steps 234-245  
on the other side.  
另一侧重复步骤234-245

248

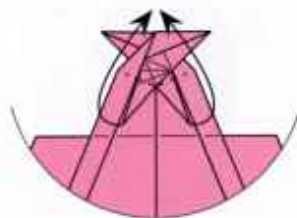

249

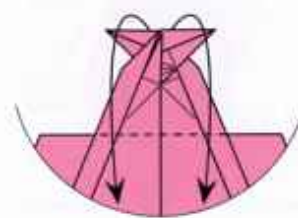

250

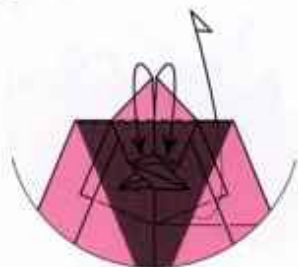

251

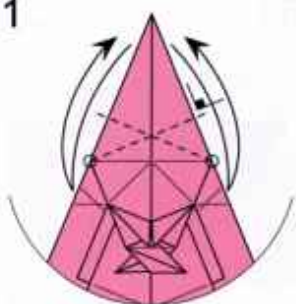

252

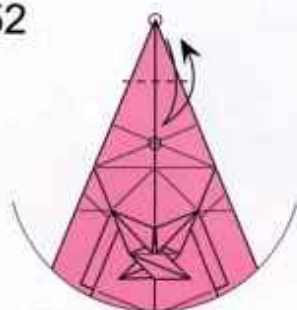

253

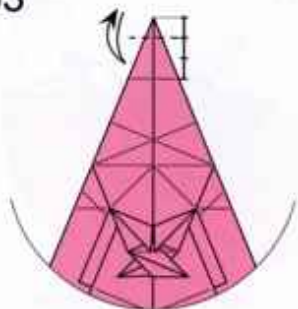

254

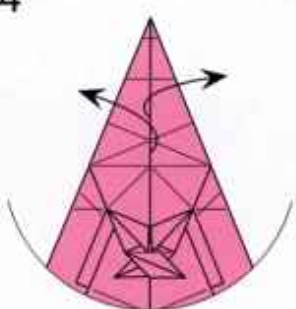

255

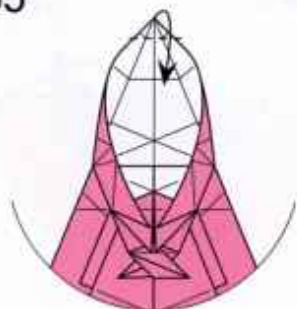

256

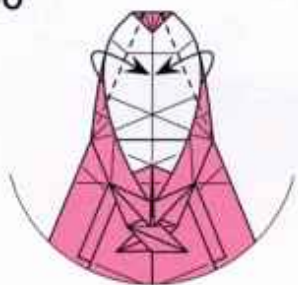

257

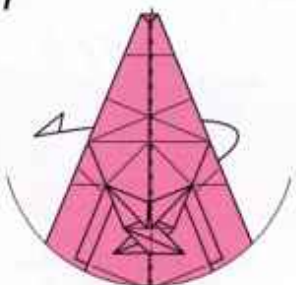

258

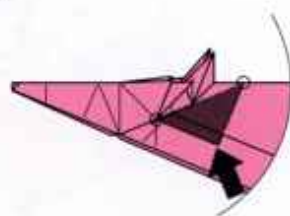

Closed sink.  
闭合沉折

259

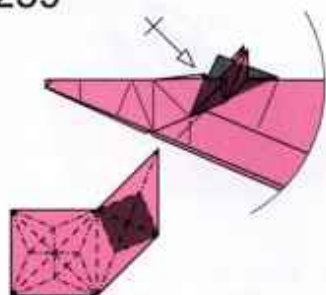

Repeat behind.  
后侧重复

260

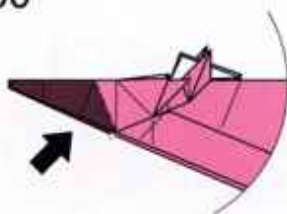

Open sink.  
开放沉折

261

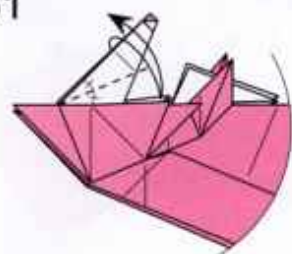

262

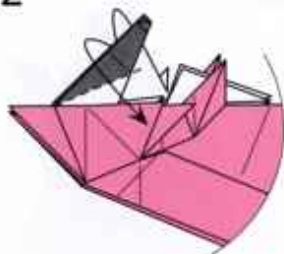

Reverse-fold all layers.  
所有纸层翻折

263

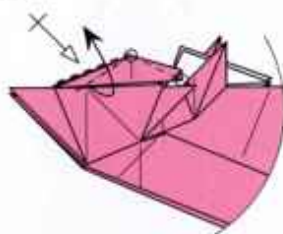

Swivel-fold.Repeat behind.  
旋转折, 后侧重复

264

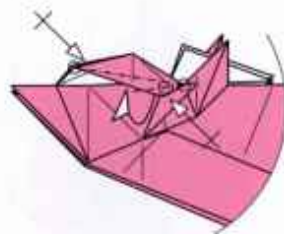

Mountain-fold.  
峰折

265

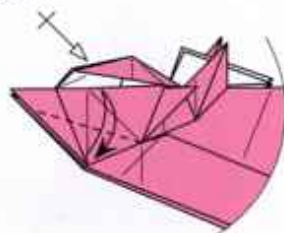

266

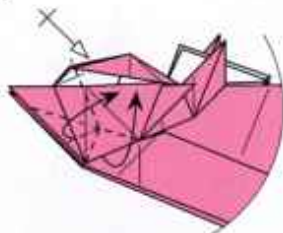

Collapse according to the creases.  
按峰谷聚合

267

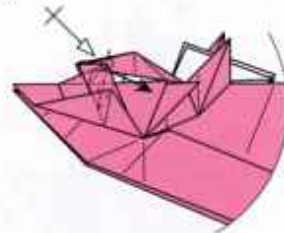

Inside reverse-fold  
along the angle bisector.  
沿角平分线内翻折

268

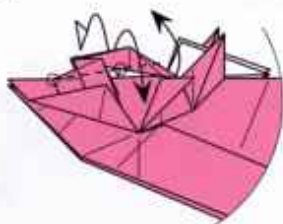

Valley-fold on both sides  
and pull the corner up..  
两侧谷折并将纸角上拉

269

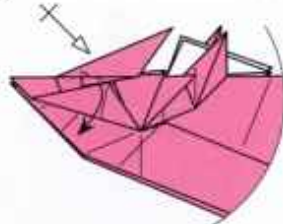

Swivel-fold.Repeat behind.  
旋转折, 后侧重复

270

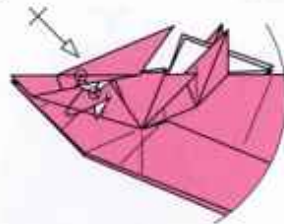

271

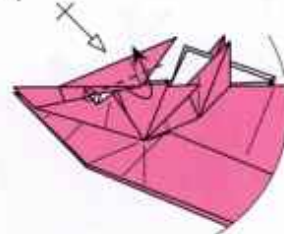

272

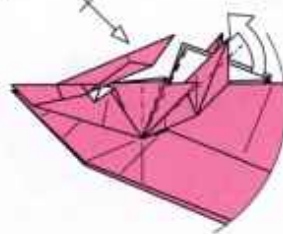

Swivel-fold.Repeat behind.  
旋转折, 后侧重复

273



Swivel-fold.Repeat behind.  
旋转折, 后侧重复

274

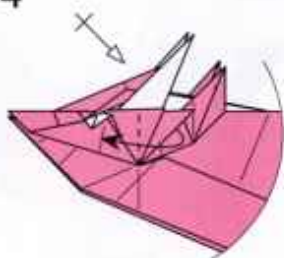

275

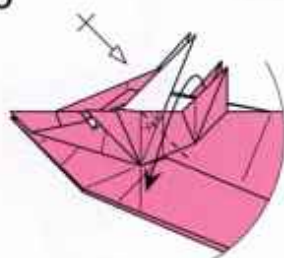

276

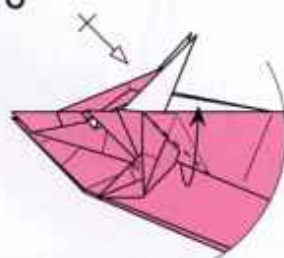

Swivel-fold. Repeat behind.  
旋转折, 后侧重复

277

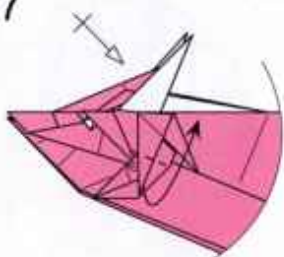

278

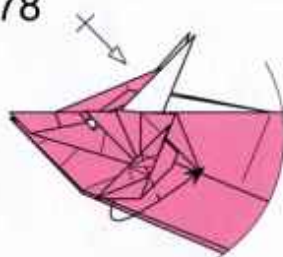

279

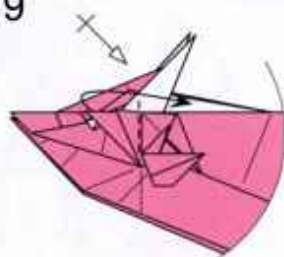

280

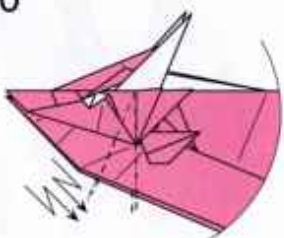

Crimp.  
双向段折

281

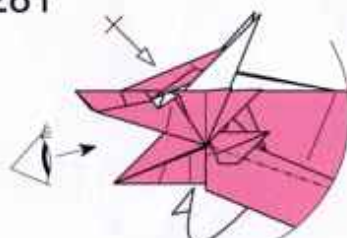

Change perspective.  
视角转换

282

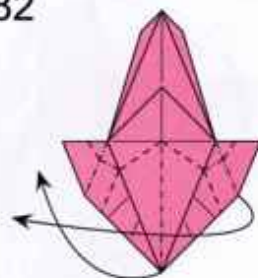

283

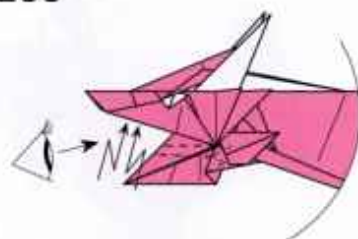

Change perspective.  
视角转换

284

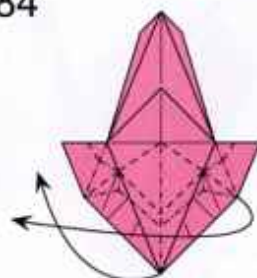

Collapse according to the creases.  
按峰谷聚合

285

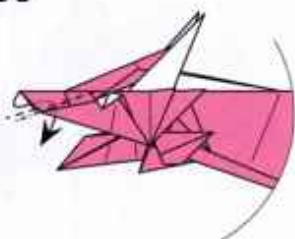

Inside reverse-fold.  
内翻折

286

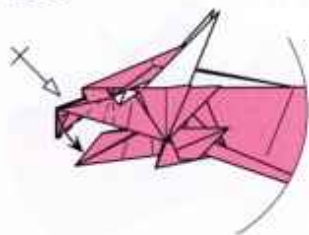

Swivel-fold. Repeat behind.  
旋转折, 后侧重复

287

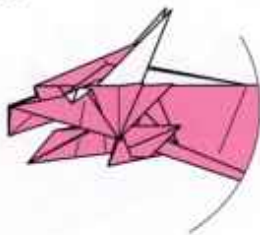

Zoom out.  
视图复原

288

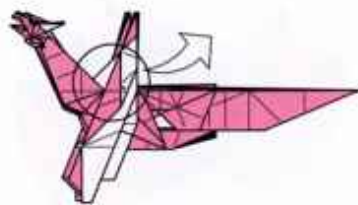

Zoom in.  
局部视图放大

289

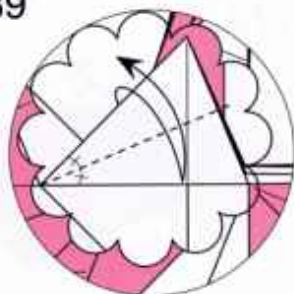

X-ray view.  
透视视角

290

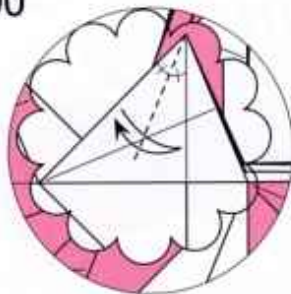

291

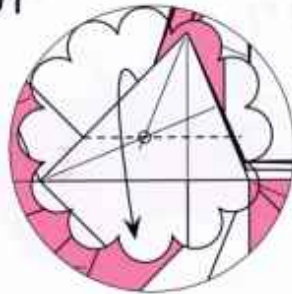

292

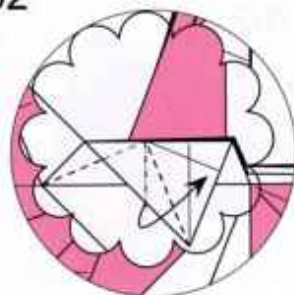

Swivel-fold.  
旋转折

293

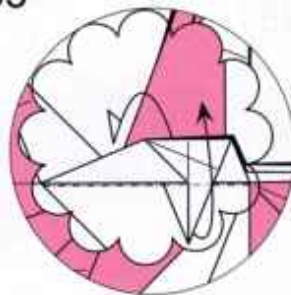

294

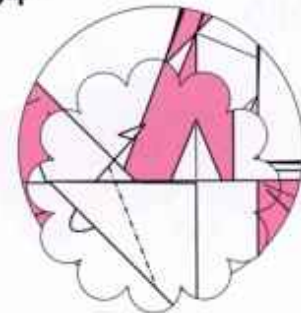

295

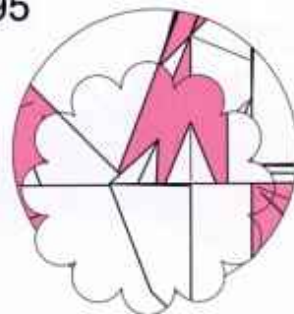

296

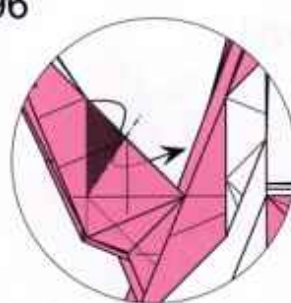

Reverse-fold all layers.  
所有纸层翻折

297

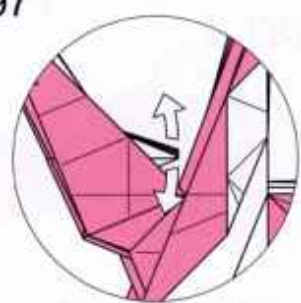

Pull up the corners.  
将纸角上拉

298

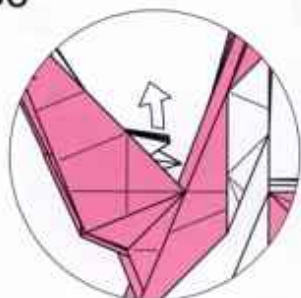

Pull up the corners.  
将纸角上拉

299

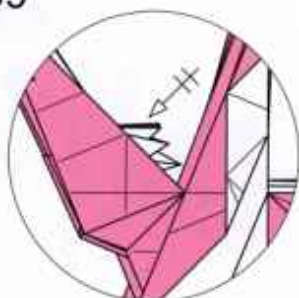

Repeat on the other two layers.  
另外两层重复

300

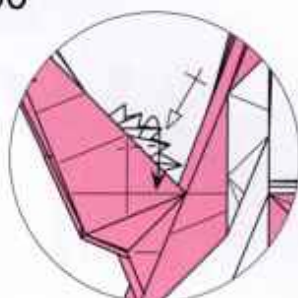

301



302

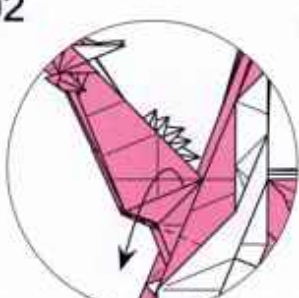

303

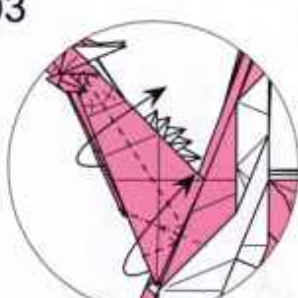

Collapse according to the creases.  
按峰谷聚合

304

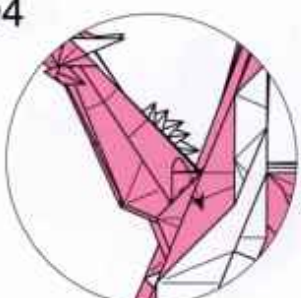

Inside reverse-fold.  
内翻折

305

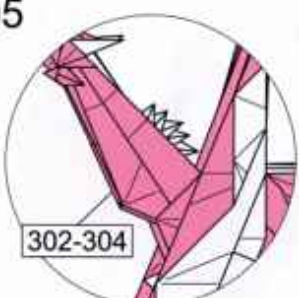

Repeat steps 302 to 304  
on the other side. Zoom out.  
另一侧重复步骤302-304, 视图复原

306

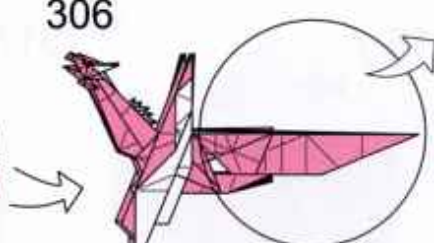

Zoom in.  
局部视图放大

307

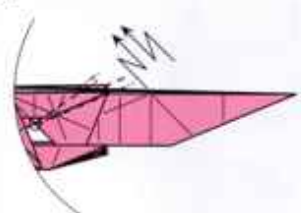

Crimp.  
双向段折

308

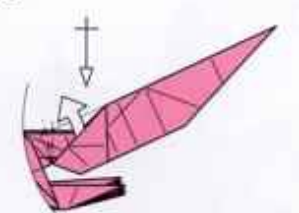

Pull out the hidden layer. Repeat behind.  
引出内部纸层, 后侧重复

309

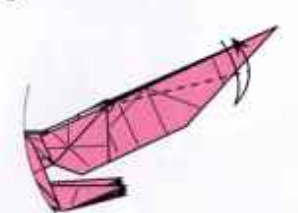

310



Crimp.  
双向段折

311



Closed sink.Repeat behind.  
闭合沉折, 后侧重复

312

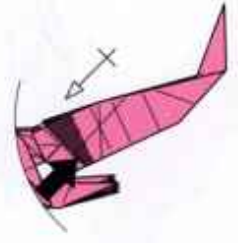

313



Adjust the layers.  
调整纸层

314

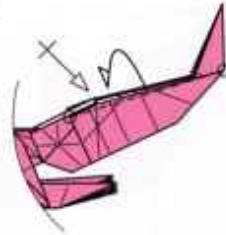

Swivel along the crease.Repeat behind.  
沿折痕旋转, 后侧重复

315



Pull out the hidden layer.  
引出内部纸层

316

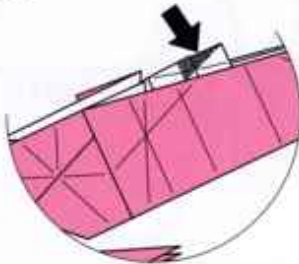

Complex sink.  
复杂沉折

317

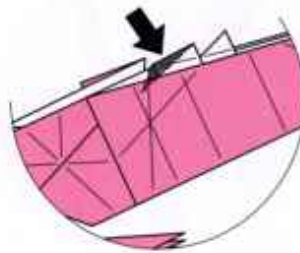

Open sink.  
开放沉折

318

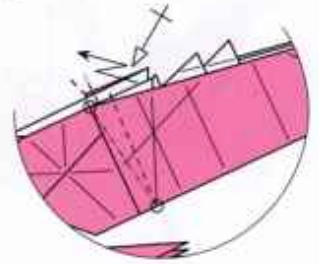

Pleat-fold.Repeat behind.  
段折, 后侧重复

319

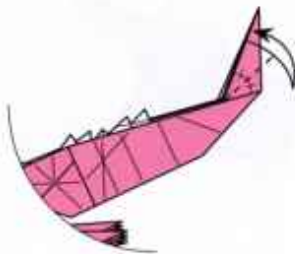

320

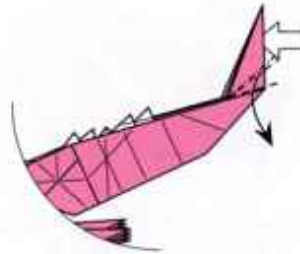

Squash fold.  
撑开压平

321

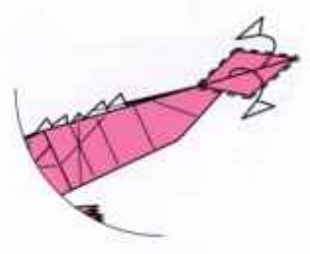

Unwrap to color change.  
翻双色



118

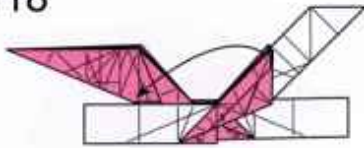

119

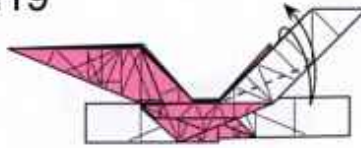

120

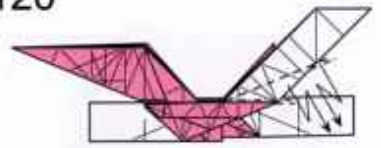

Crimp.  
双向段折

121

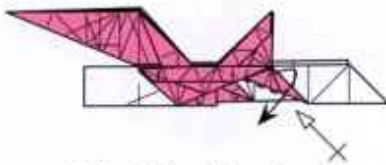

Valley-fold one layer down.  
Repeat behind.  
向下谷折一层，后侧重复

122

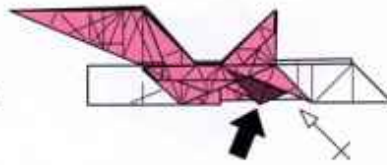

Closed sink. Repeat behind.  
闭合沉折，后侧重复

123

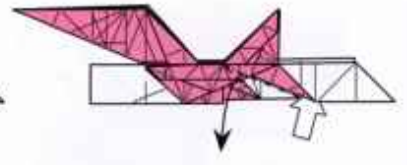

Squash fold. The model will not stay flat.  
撑开纸层，模型无法压平

124

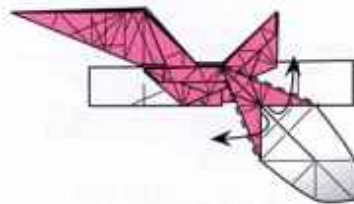

125

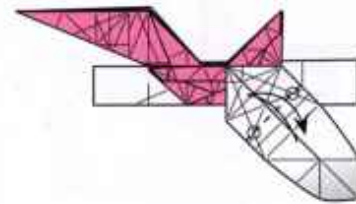

126

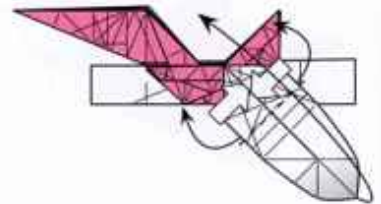

Open the layers  
and flatten along the creases.  
打开纸层并沿峰谷压平

127

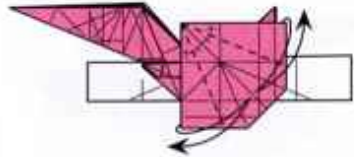

128

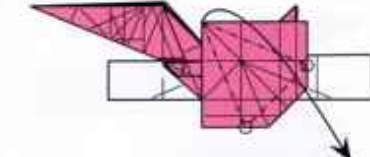

Petal-fold.  
花瓣折

129

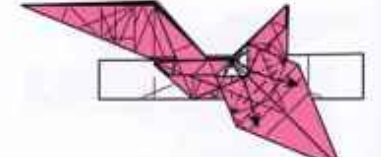

Swivel-folds.  
旋转折

310



Crimp.  
双向段折

311



Closed sink.Repeat behind.  
闭合沉折, 后侧重复

312

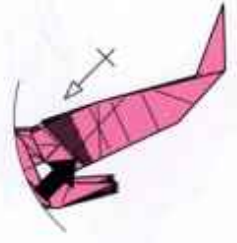

313



Adjust the layers.  
调整纸层

314

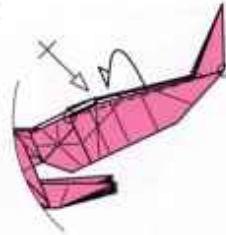

Swivel along the crease.Repeat behind.  
沿折痕旋转, 后侧重复

315



Pull out the hidden layer.  
引出内部纸层

316

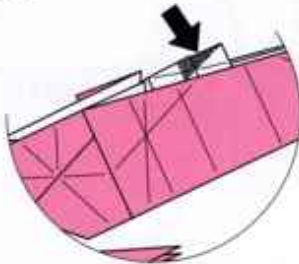

Complex sink.  
复杂沉折

317

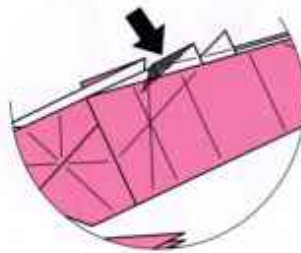

Open sink.  
开放沉折

318

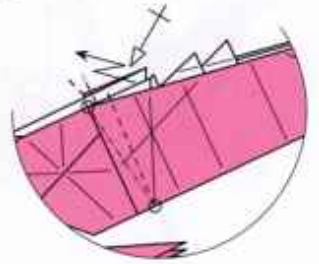

Pleat-fold.Repeat behind.  
段折, 后侧重复

319



320

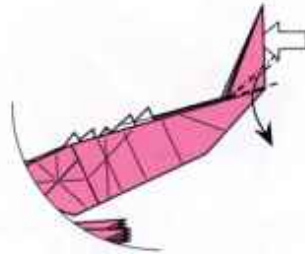

Squash fold.  
撑开压平

321

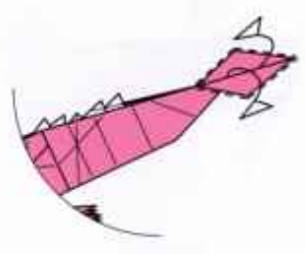

Unwrap to color change.  
翻双色

118

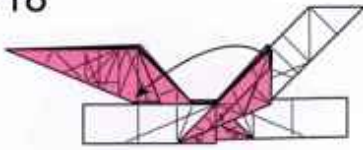

119

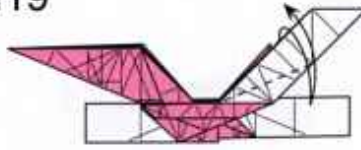

120

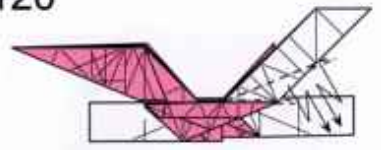

Crimp.  
双向段折

121

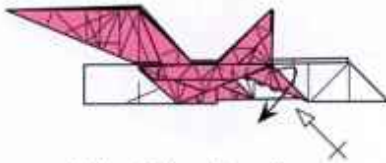

Valley-fold one layer down.  
Repeat behind.  
向下谷折一层，后侧重复

122

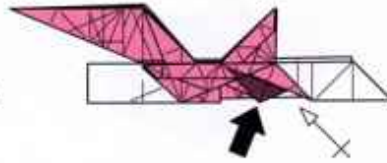

Closed sink. Repeat behind.  
闭合沉折，后侧重复

123

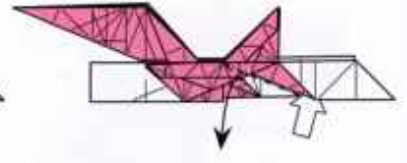

Squash fold. The model will not stay flat.  
撑开纸层，模型无法压平

124

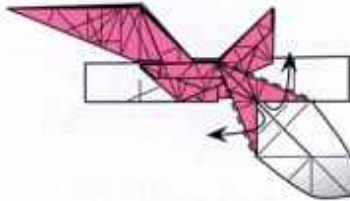

125

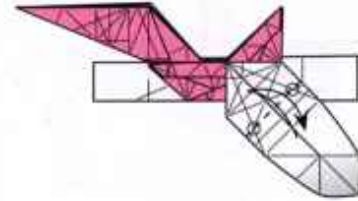

126

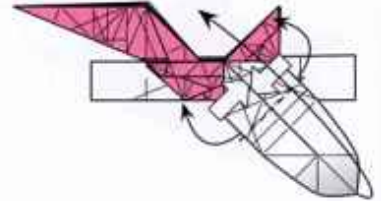

Open the layers  
and flatten along the creases.  
打开纸层并沿峰谷压平

127

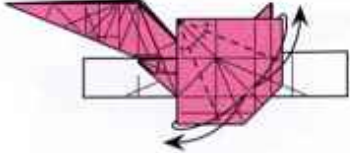

128

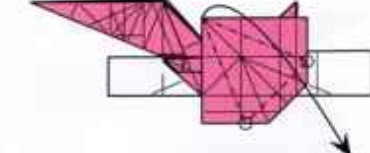

Petal-fold.  
花瓣折

129

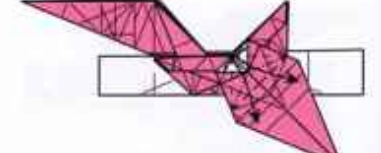

Swivel-folds.  
旋转折

310



Crimp.  
双向段折

311



312

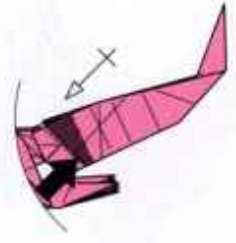

Closed sink.Repeat behind.  
闭合沉折, 后侧重复

313



Adjust the layers.  
调整纸层

314

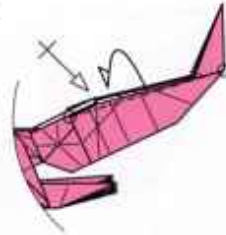

Swivel along the crease.Repeat behind.  
沿折痕旋转, 后侧重复

315



Pull out the hidden layer.  
引出内部纸层

316

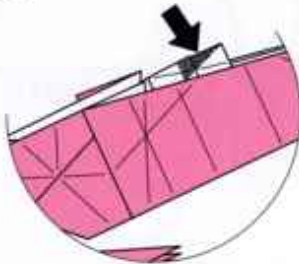

Complex sink.  
复杂沉折

317

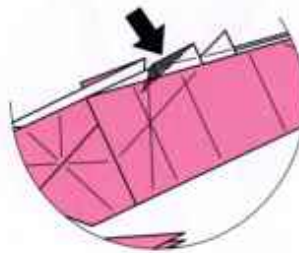

Open sink.  
开放沉折

318

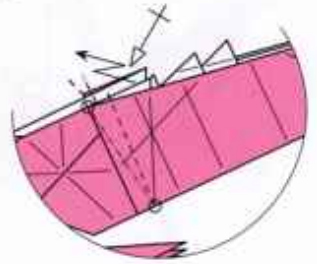

Pleat-fold.Repeat behind.  
段折, 后侧重复

319

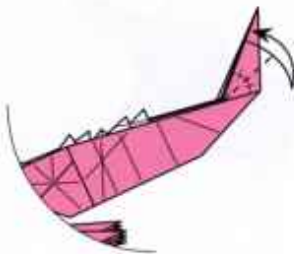

320

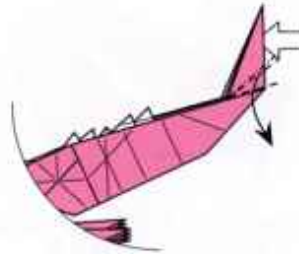

Squash fold.  
撑开压平

321

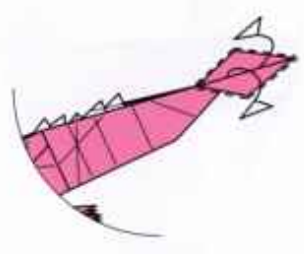

Unwrap to color change.  
翻双色

118

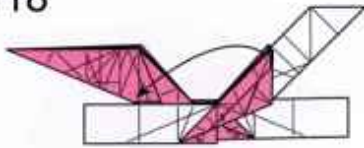

119

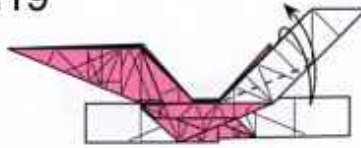

120

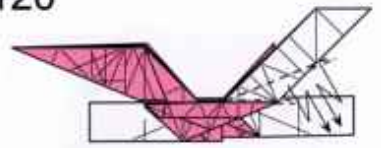

Crimp.  
双向段折

121

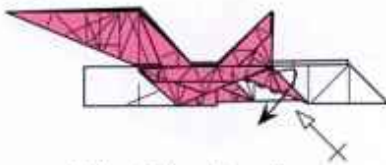

Valley-fold one layer down.  
Repeat behind.  
向下谷折一层，后侧重复

122

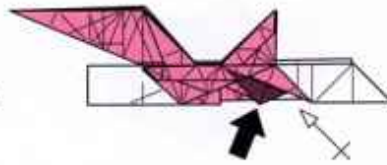

Closed sink. Repeat behind.  
闭合沉折，后侧重复

123

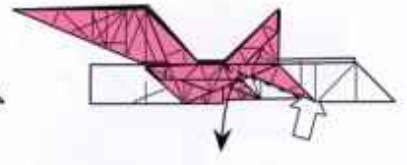

Squash fold. The model will not stay flat.  
撑开纸层，模型无法压平

124

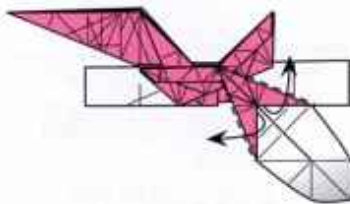

125

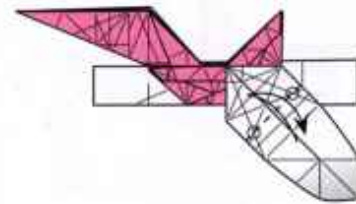

126

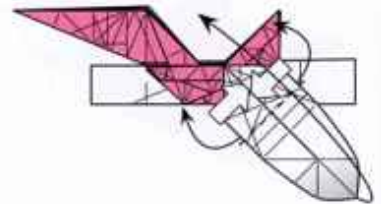

Open the layers  
and flatten along the creases.  
打开纸层并沿峰谷压平

127

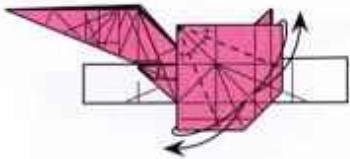

128

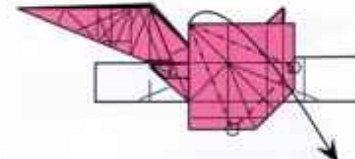

Petal-fold.  
花瓣折

129

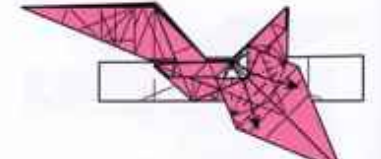

Swivel-folds.  
旋转折

310



Crimp.  
双向段折

311



Closed sink.Repeat behind.  
闭合沉折, 后侧重复

312

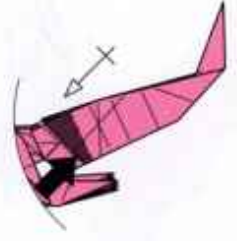

313



Adjust the layers.  
调整纸层

314

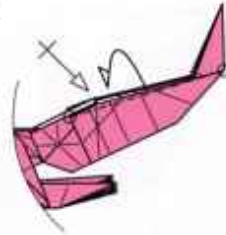

Swivel along the crease.Repeat behind.  
沿折痕旋转, 后侧重复

315



Pull out the hidden layer.  
引出内部纸层

316

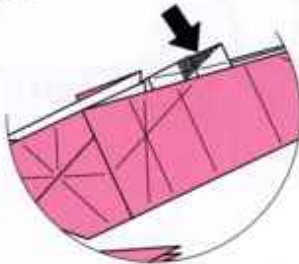

Complex sink.  
复杂沉折

317

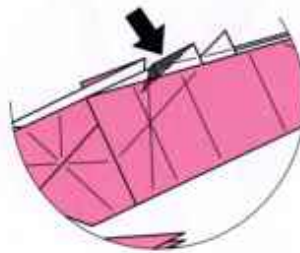

Open sink.  
开放沉折

318

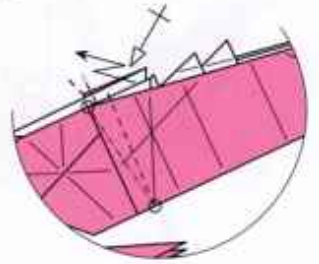

Pleat-fold.Repeat behind.  
段折, 后侧重复

319



320

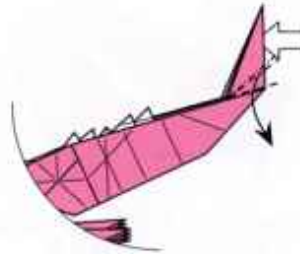

Squash fold.  
撑开压平

321

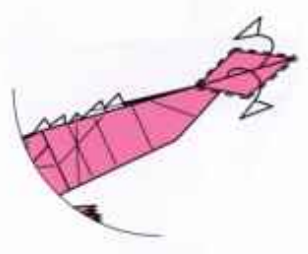

Unwrap to color change.  
翻双色

118

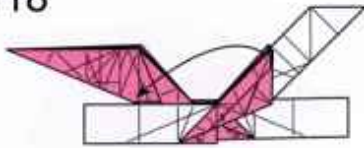

119

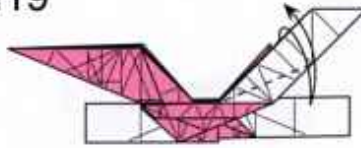

120

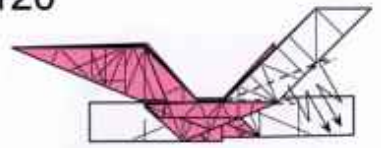

Crimp.  
双向段折

121

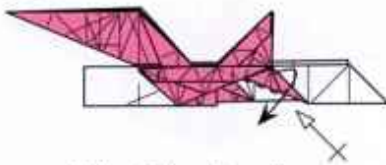

Valley-fold one layer down.  
Repeat behind.  
向下谷折一层，后侧重复

122

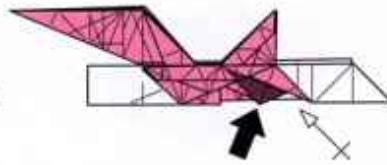

Closed sink. Repeat behind.  
闭合沉折，后侧重复

123

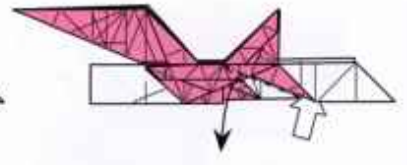

Squash fold. The model will not stay flat.  
撑开纸层，模型无法压平

124

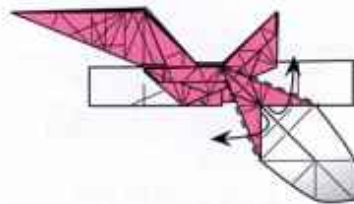

125

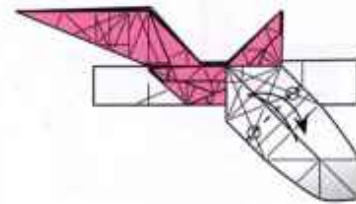

126

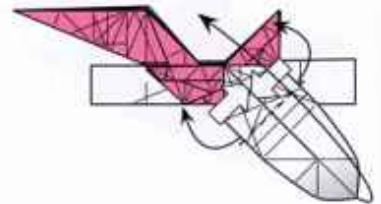

Open the layers  
and flatten along the creases.  
打开纸层并沿峰谷压平

127

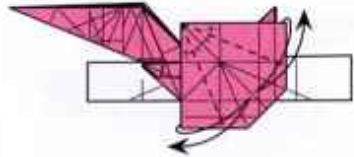

128

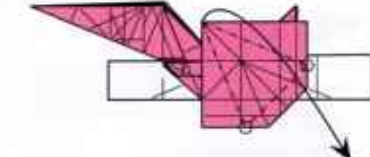

Petal-fold.  
花瓣折

129

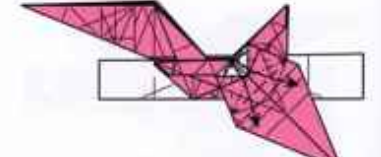

Swivel-folds.  
旋转折

310



Crimp.  
双向段折

311



Closed sink.Repeat behind.  
闭合沉折, 后侧重复

312

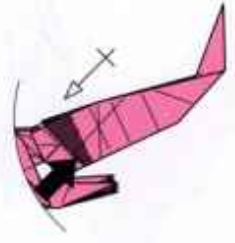

313



Adjust the layers.  
调整纸层

314

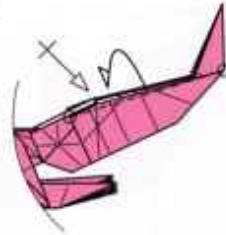

Swivel along the crease.Repeat behind.  
沿折痕旋转, 后侧重复

315



Pull out the hidden layer.  
引出内部纸层

316

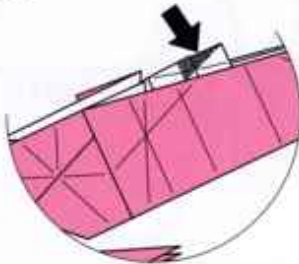

Complex sink.  
复杂沉折

317

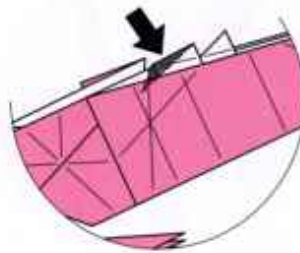

Open sink.  
开放沉折

318

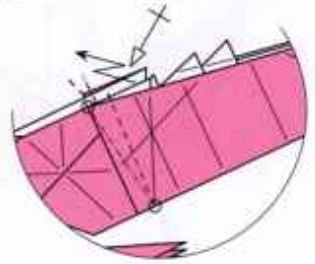

Pleat-fold.Repeat behind.  
段折, 后侧重复

319

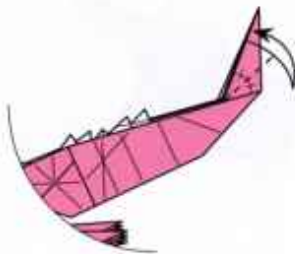

320

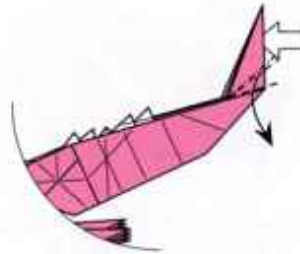

Squash fold.  
撑开压平

321

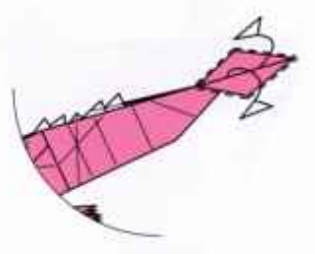

Unwrap to color change.  
翻双色



118

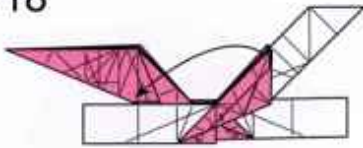

119

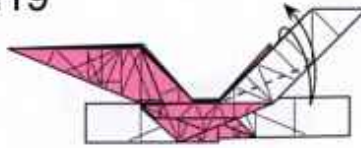

120

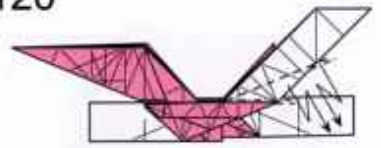

Crimp.  
双向段折

121

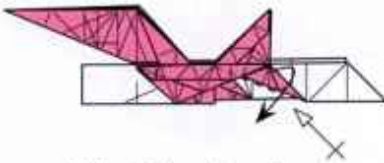

Valley-fold one layer down.  
Repeat behind.  
向下谷折一层，后侧重复

122

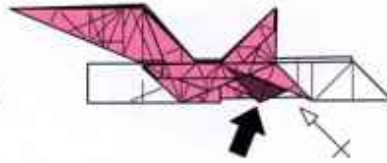

Closed sink.Repeat behind.  
闭合沉折，后侧重复

123

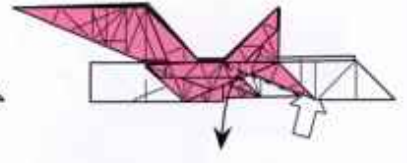

Squash fold.The model will not stay flat.  
撑开纸层，模型无法压平

124

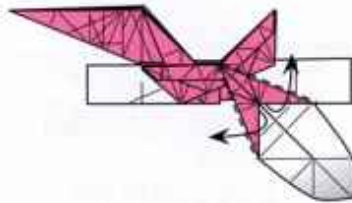

125

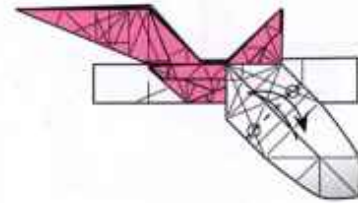

126

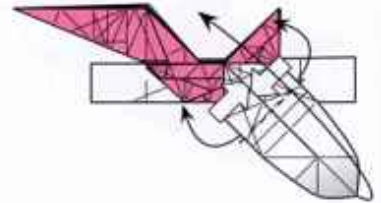

Open the layers  
and flatten along the creases.  
打开纸层并沿峰谷压平

127

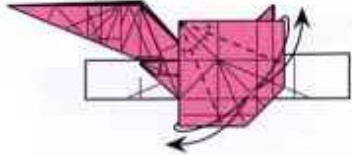

128

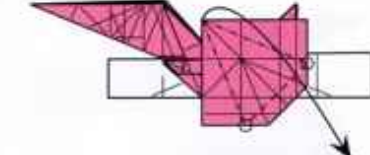

Petal-fold.  
花瓣折

129

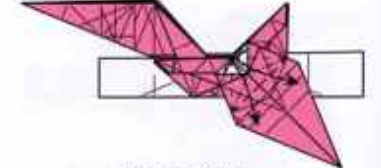

Swivel-folds.  
旋转折

310



Crimp.  
双向段折

311



Closed sink.Repeat behind.  
闭合沉折, 后侧重复

312

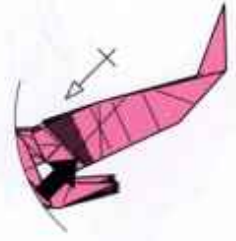

313



Adjust the layers.  
调整纸层

314

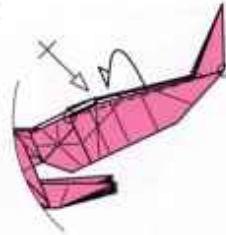

Swivel along the crease.Repeat behind.  
沿折痕旋转, 后侧重复

315



Pull out the hidden layer.  
引出内部纸层

316

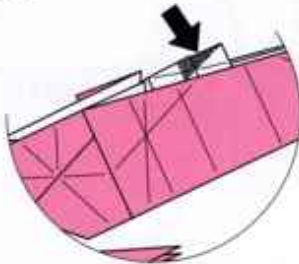

Complex sink.  
复杂沉折

317

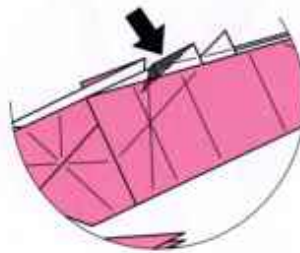

Open sink.  
开放沉折

318

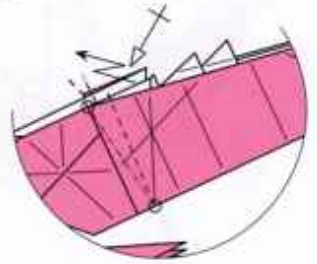

Pleat-fold.Repeat behind.  
段折, 后侧重复

319



320

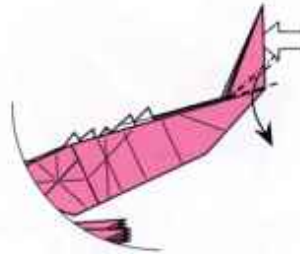

Squash fold.  
撑开压平

321

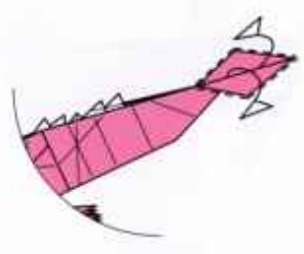

Unwrap to color change.  
翻双色

310



Crimp.  
双向段折

311



Closed sink.Repeat behind.  
闭合沉折, 后侧重复

312

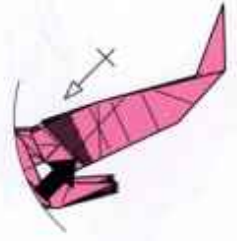

313



Adjust the layers.  
调整纸层

314

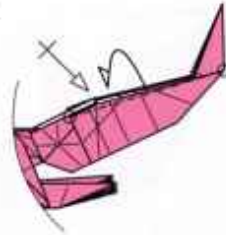

Swivel along the crease.Repeat behind.  
沿折痕旋转, 后侧重复

315



Pull out the hidden layer.  
引出内部纸层

316

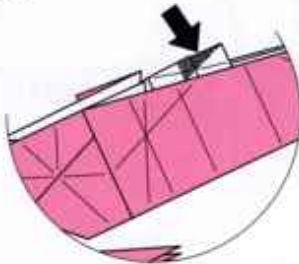

Complex sink.  
复杂沉折

317

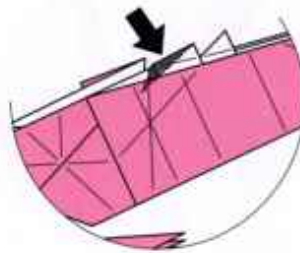

Open sink.  
开放沉折

318

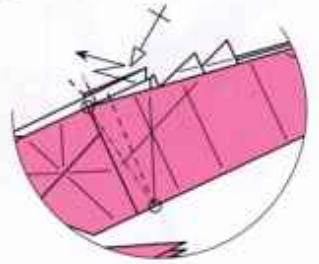

Pleat-fold.Repeat behind.  
段折, 后侧重复

319



320

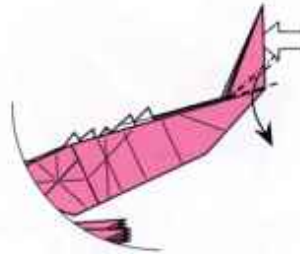

Squash fold.  
撑开压平

321

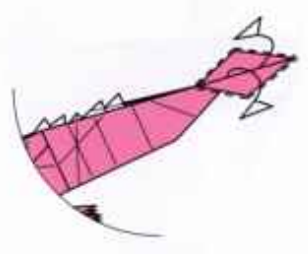

Unwrap to color change.  
翻双色

322

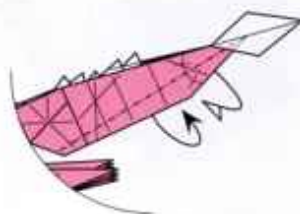

Mountain-fold along the angle bisectors.  
沿角平分线峰折

323

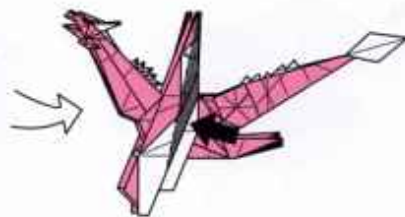

Closed sink.  
闭合沉折

324

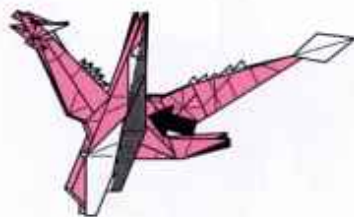

Closed sink.  
闭合沉折

325



Zoom in.  
局部视图放大

326

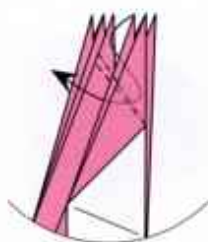

Inside reverse-fold.  
内翻折

327

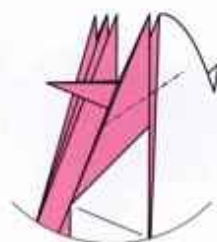

328



Swivel-fold.  
旋转折

329



Unwrap.  
将纸层后翻

330

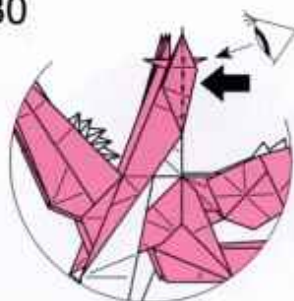

Inside reverse-fold.  
内翻折

331

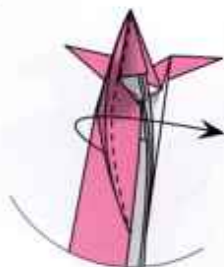

332

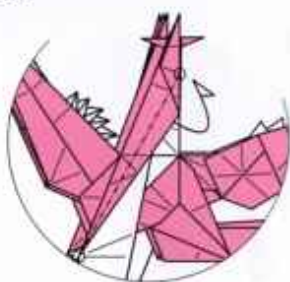

333

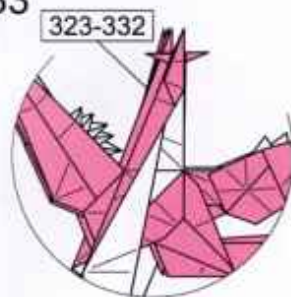

Repeat steps 323 to 332  
on the other side.  
另一侧重复步骤323-332

334

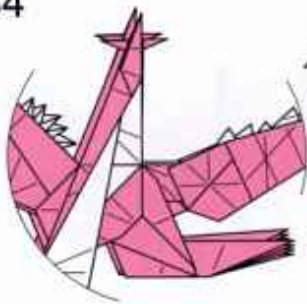

Turn over.  
翻面

335

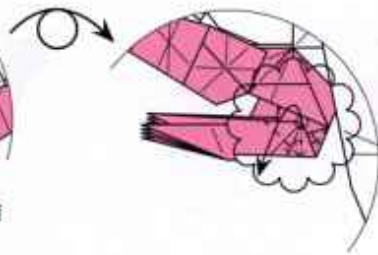

X-ray view. Swivel-fold.  
透视视角, 旋转折

336

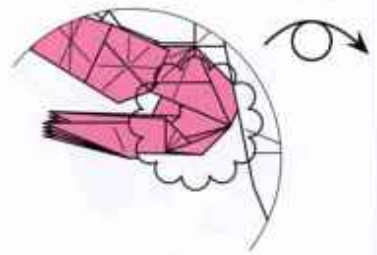

Turn over.  
翻面

337

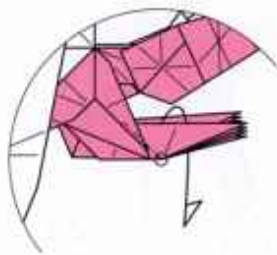

338



Outside reverse-fold.  
外翻折

339

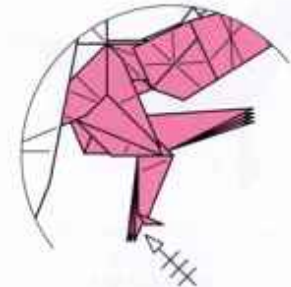

Repeat on the other three flaps.  
另外三片重复

340

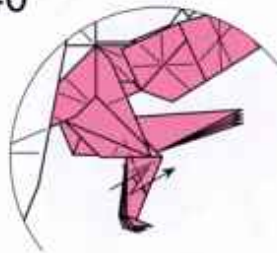

341



Mountain-fold one layer to the right.  
向右峰折一层

342

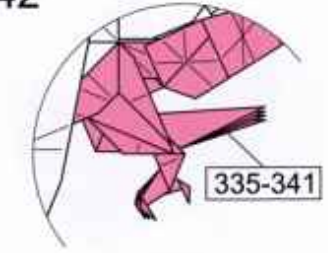

Repeat steps 335 to 341  
on the other side.  
另一侧重复步骤335-341

343

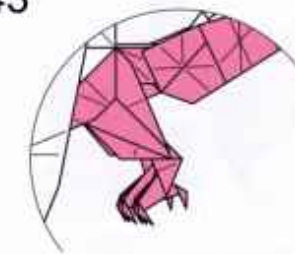

Zoom out.  
视图复原

344

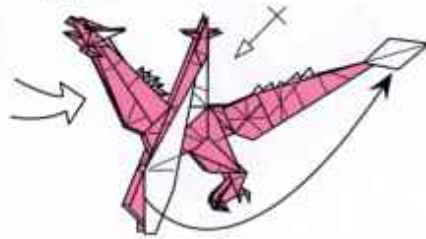

Open the layers. Repeat behind.  
打开纸层, 后侧重复

345

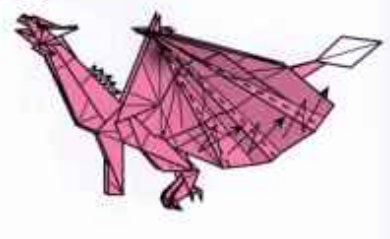

Pleat-fold.  
段折

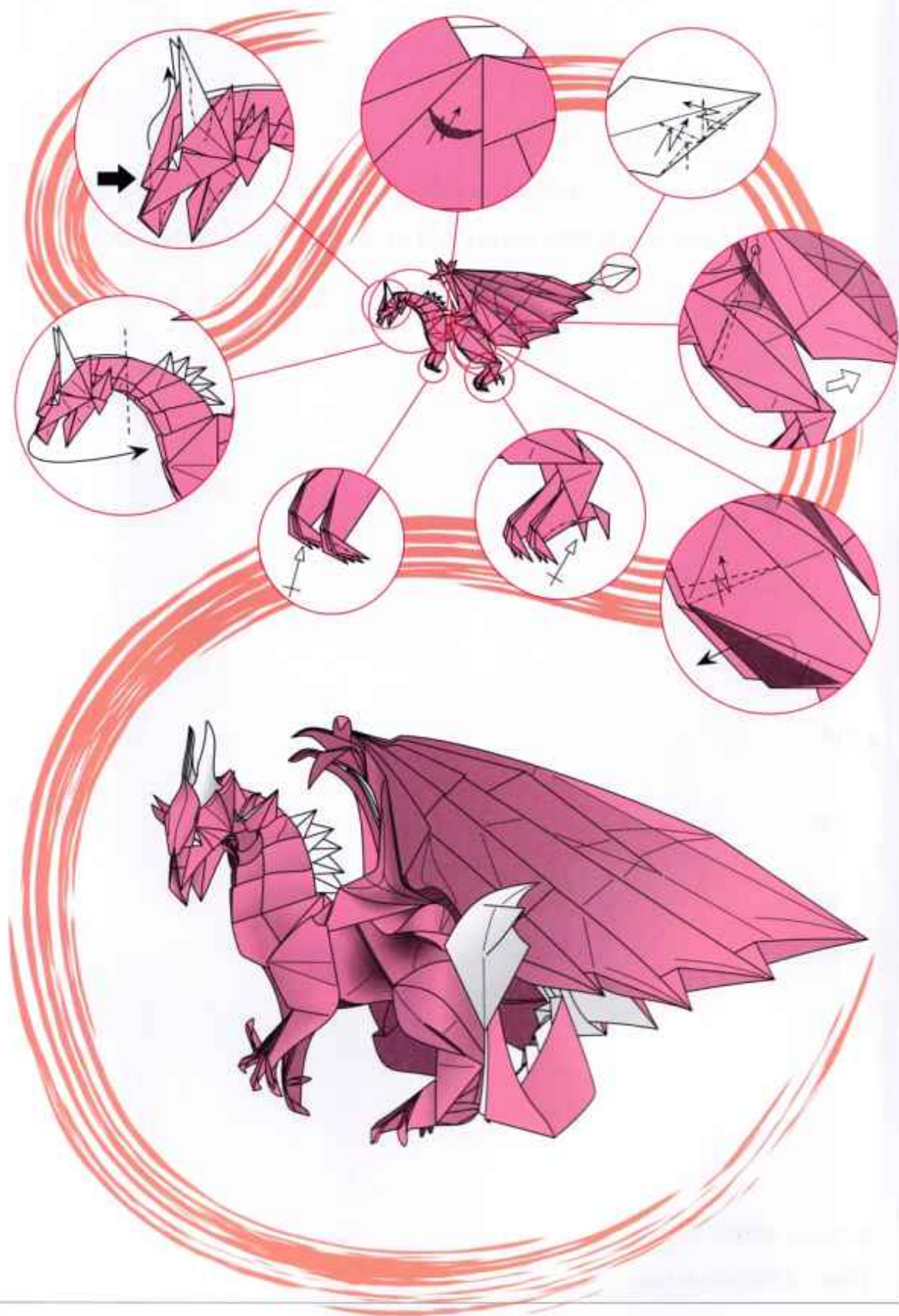

Chinese New Year Origami 2024

Copyright © 2024 Spring and Autumn Origami Club(SAOC).

All rights reserved.

Author: SAOC

ISBN: 9798990161504

