

# Pekin Duck

Seth Friedman

©2014 - New York

Complex

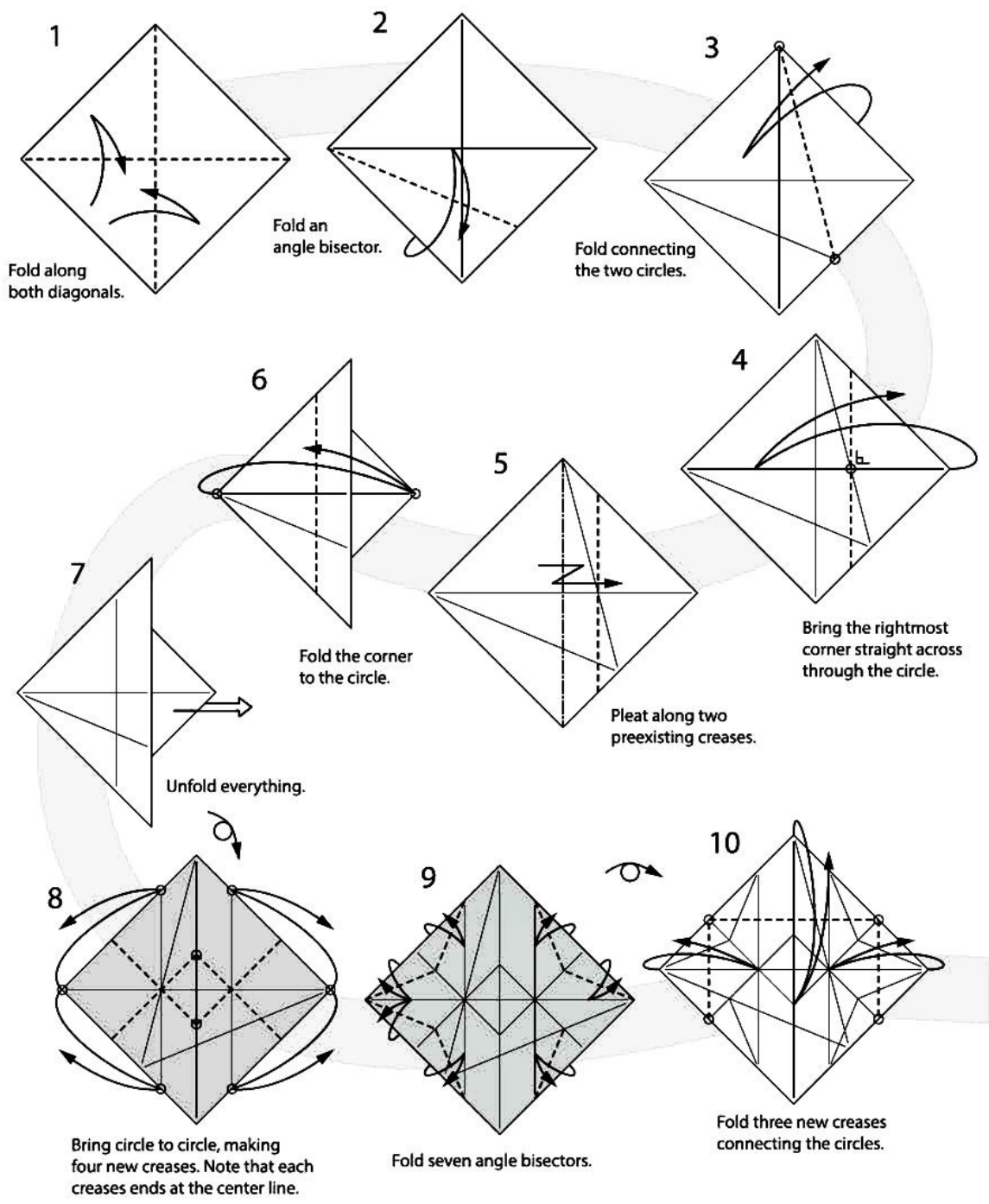

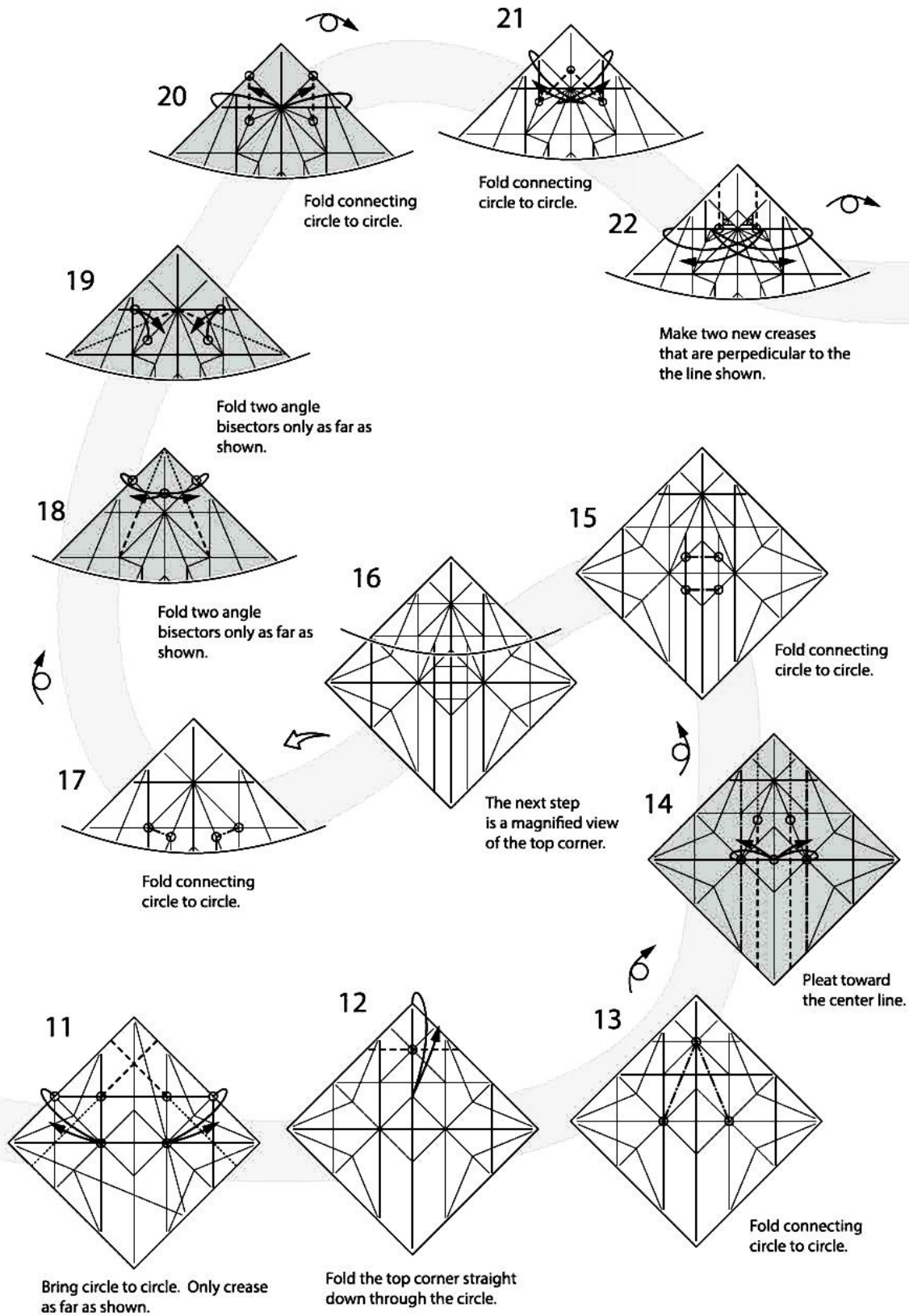

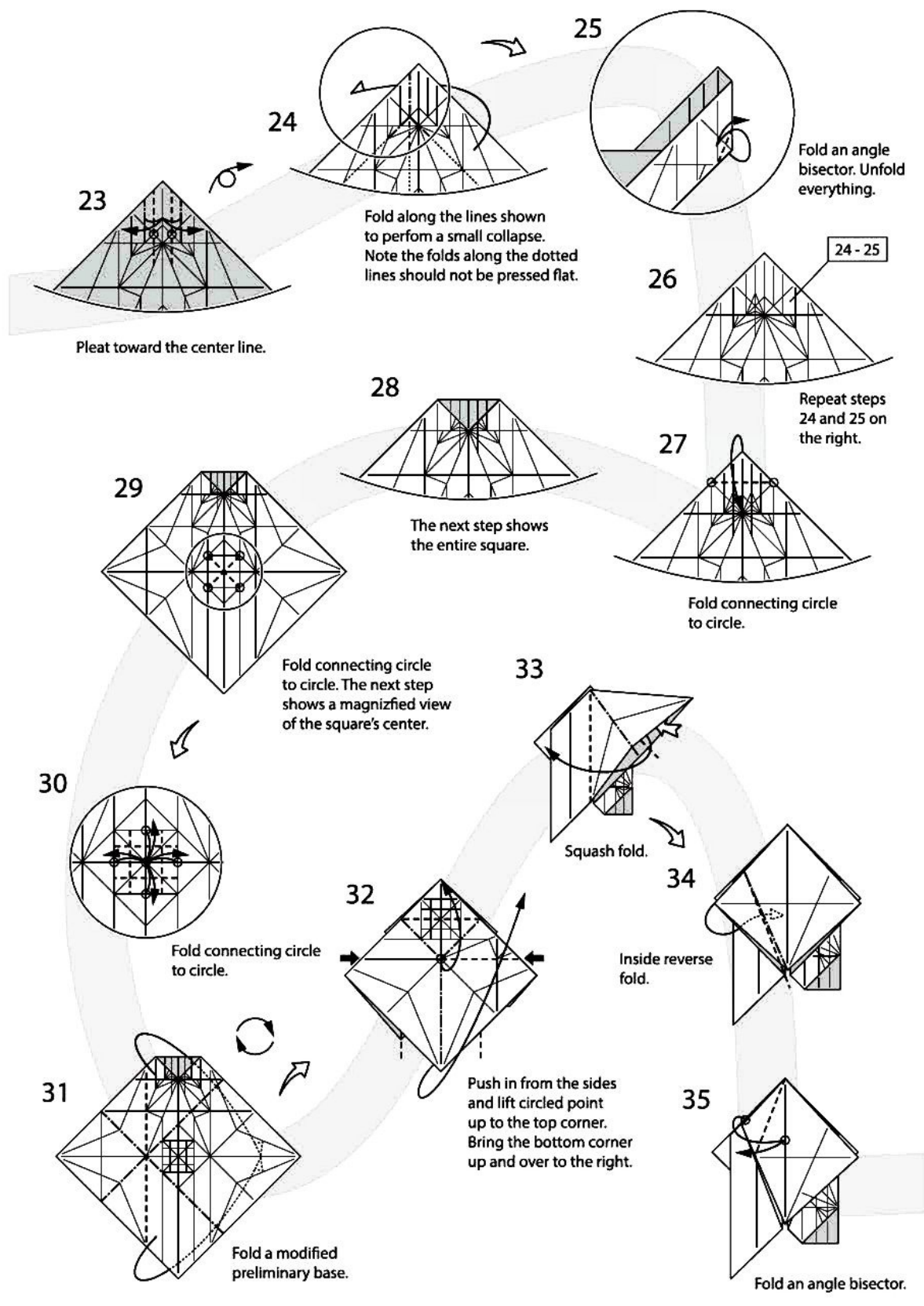

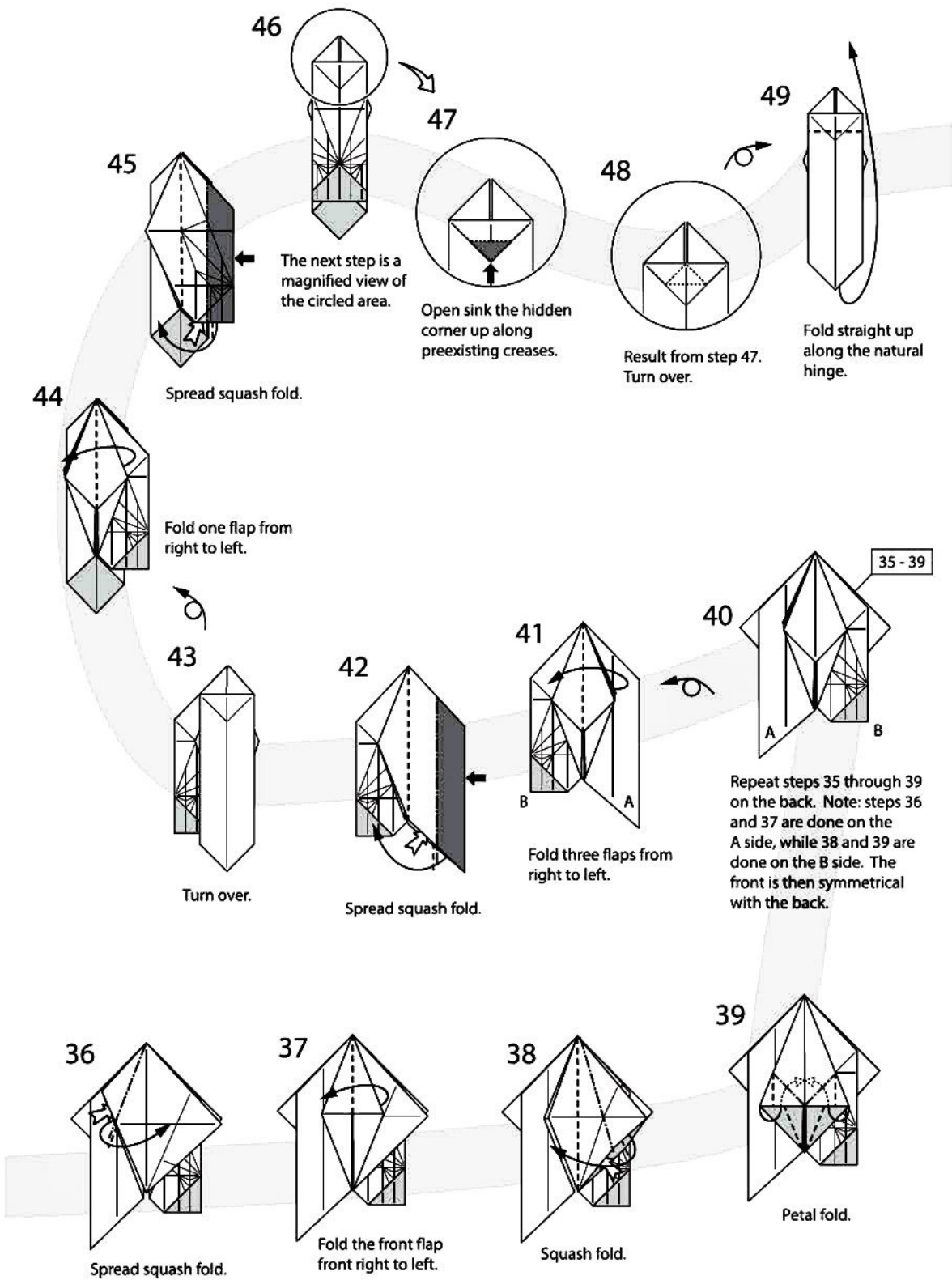

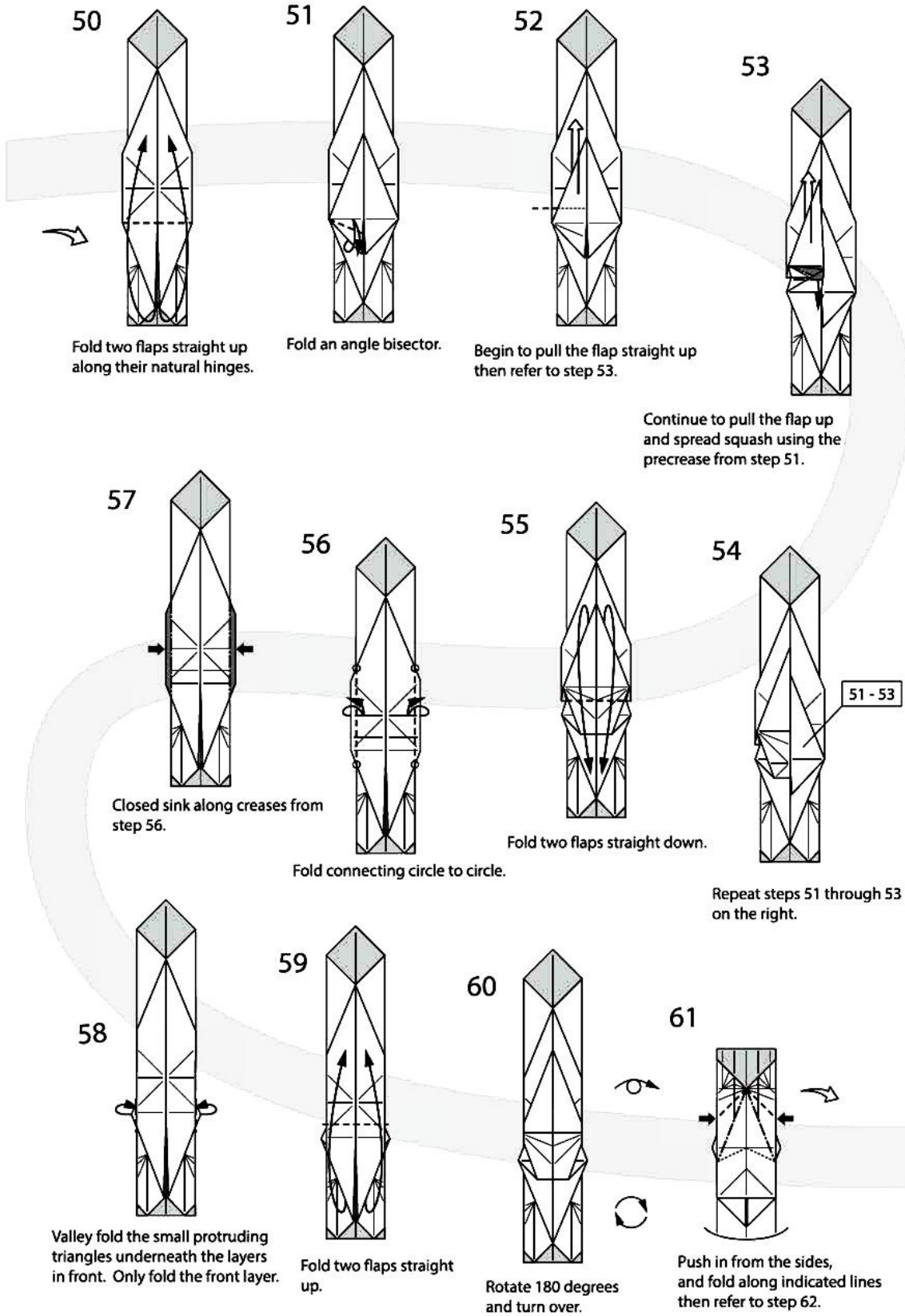

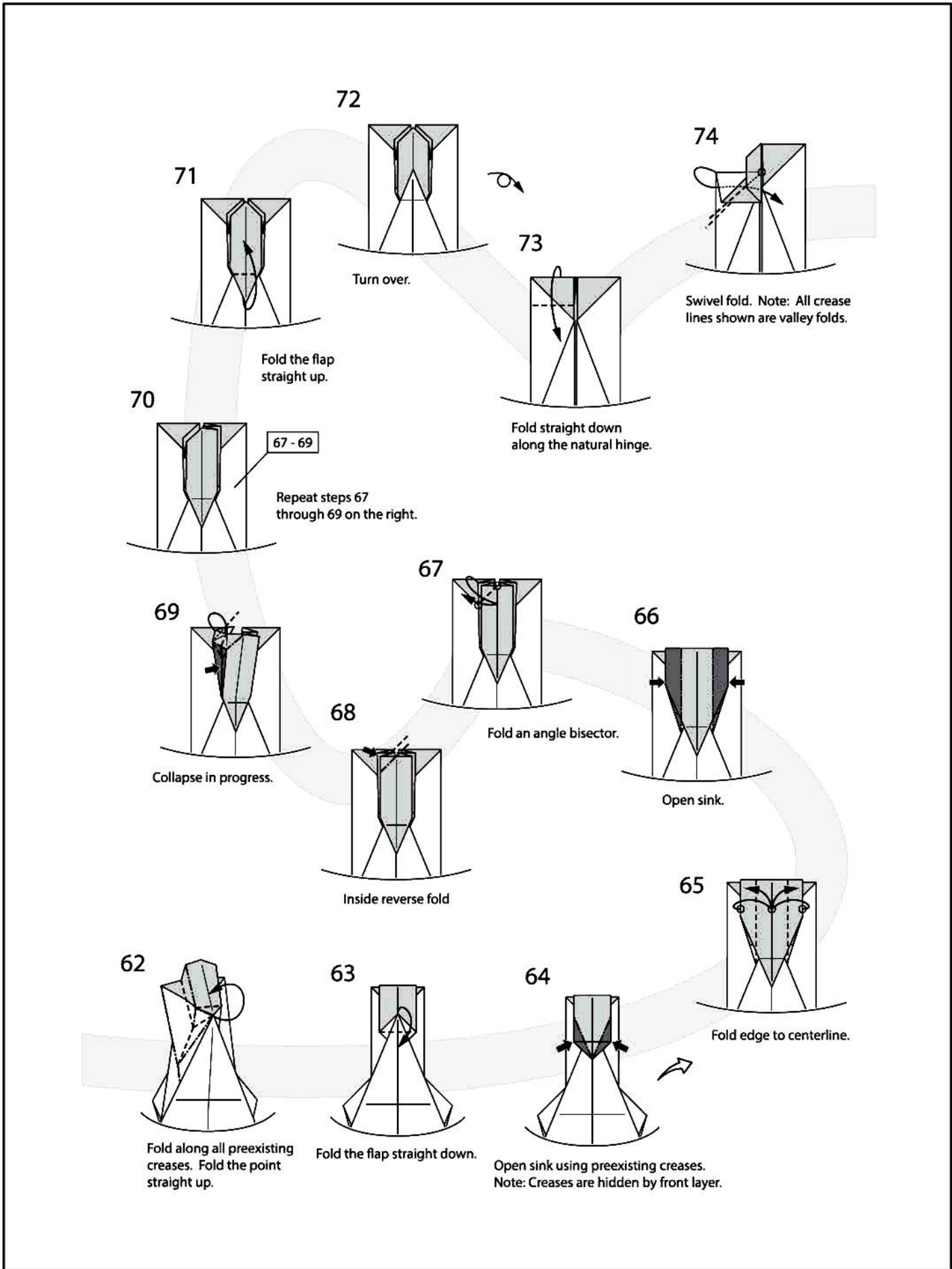

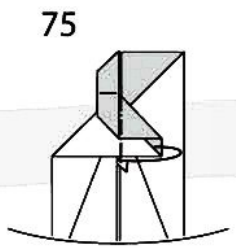

75  
Tuck the flap underneath.

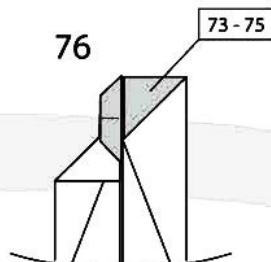

76  
Repeat steps 67 through 69 on the right.

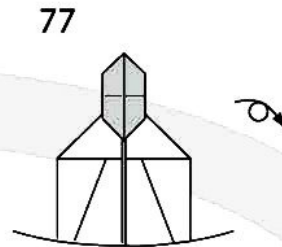

77  
Turn over.

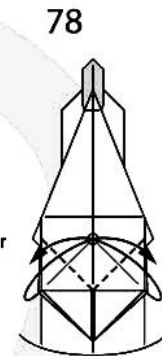

78  
Fold the corner to the circle.

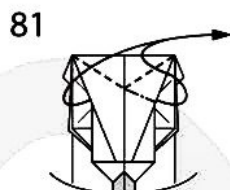

81  
Rabbit ear fold.

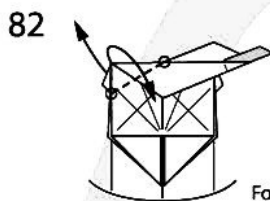

82  
Fold connecting circle to circle.

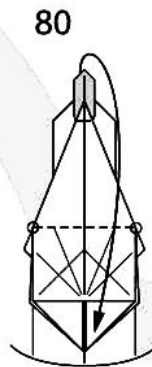

80  
Fold connecting circle to circle.

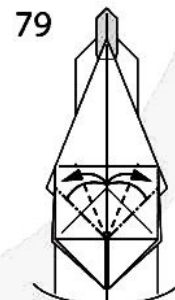

79  
Pleat toward the center line.

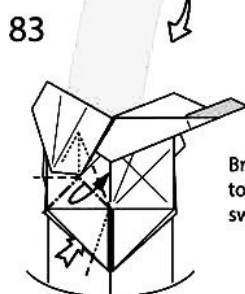

83  
Bring folded line to the centerline and swivel fold.

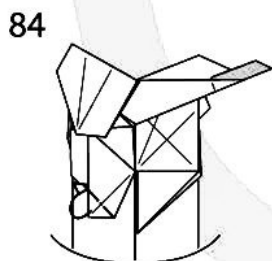

84  
Fold the excess paper inside.

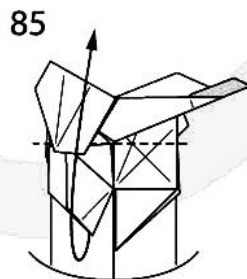

85  
Fold straight up. Note: this fold does not need to be sharp.

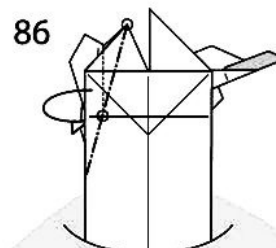

86  
Fold connecting circle to circle.

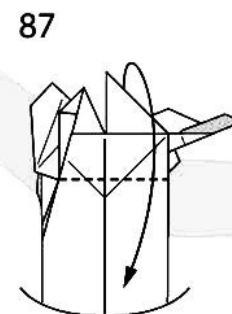

87  
Fold back down.

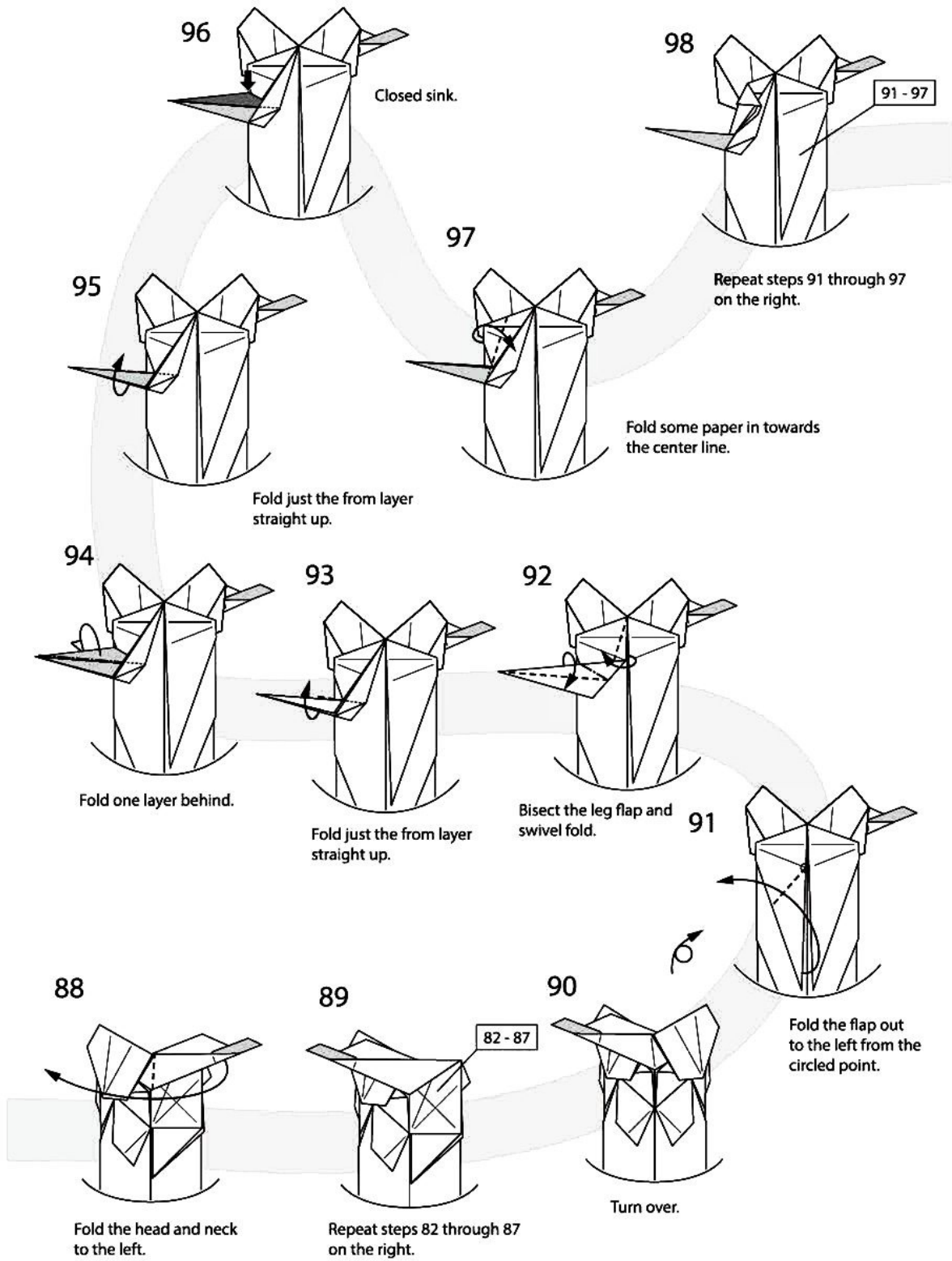



99

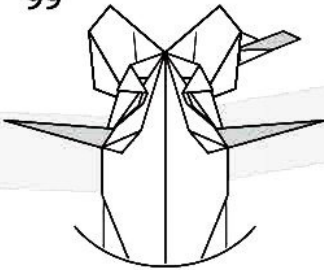

The next step is a magnified view of the bottom corner.

100

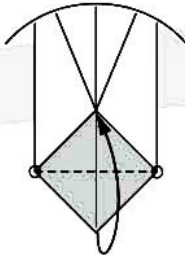

Fold connecting circle to circle.

101

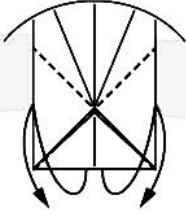

Fold two angle bisectors.

102

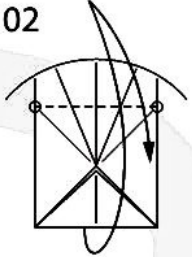

Fold connecting circle to circle.

103

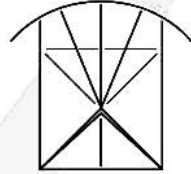

The next step shows the entire model.

105

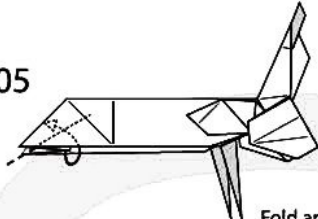

Fold an angle bisector to lock the two layers together.



104

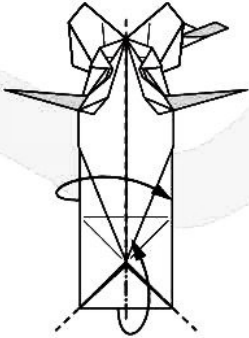

Fold everything in half with an inside reverse fold.

106

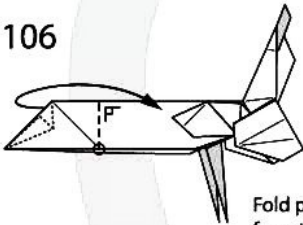

Fold perpendicular to the top edge from the circled point.

107

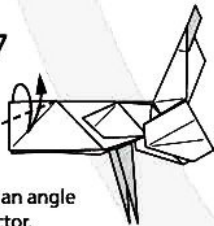

Fold an angle bisector.

109

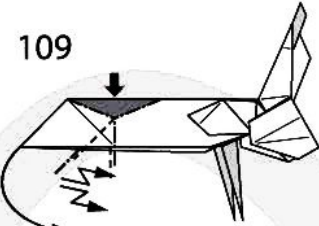

Push down on the top and crimp the flap down and to the right.

110

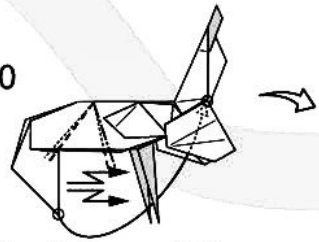

Crimp the flap up so that the circled points meet.

108

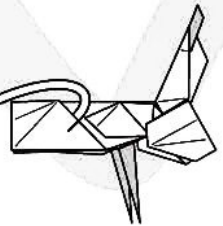

Unfold back to step 106.

119

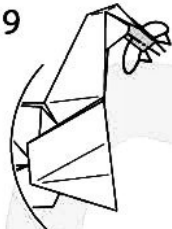

Narrow the beak.

120

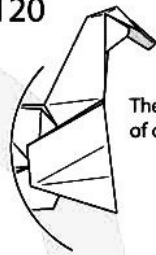

The next step is a magnified view of one leg.

Repeat steps 121 through 123 on the right.

124

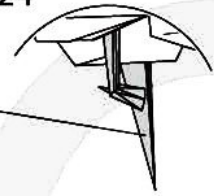

121-123

118



Crimp the head so that the edge of the cheek meets the edge of the forehead triangle.

121

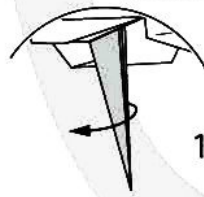

Spread 3 layers apart near the tip of the flap.

123



The foot should look like this. Rotate the foot 90 degrees. Pleat the back toe.

122

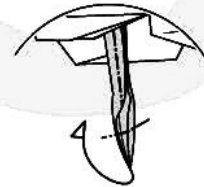

Fold the tip of the flap back to form the front edge of the feet. Shape the leg and three front toes.

117

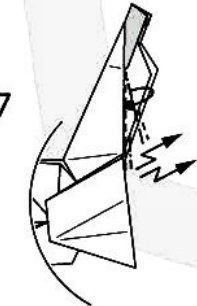

Crimp the neck and hide some paper under the front layer.

116

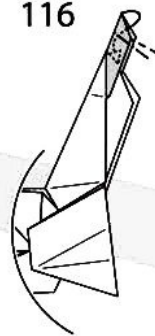

Reverse fold the tip of the beak inside.

115

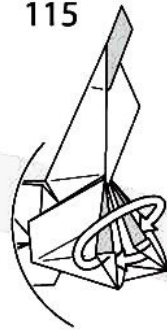

114

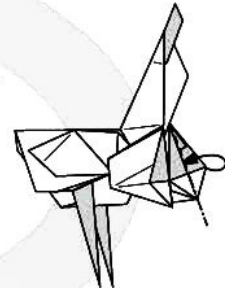

Inside reverse fold on the back.

111

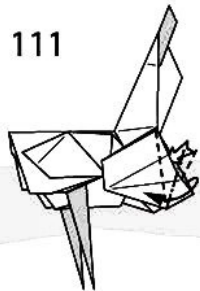

Symmetrical squash fold.

112

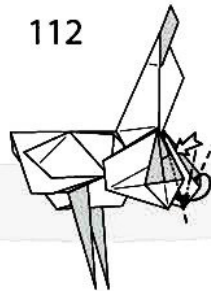

Symmetrical squash fold on the back.

113

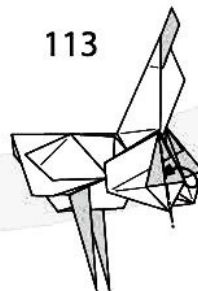

Inside reverse fold.

125

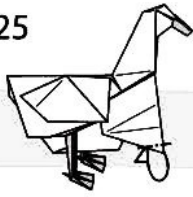

Fold the tip of the chest flap inside to lock it together.

126

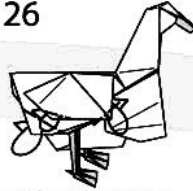

Round some corners. Repeat on the back.

127

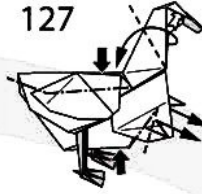

Round the back and flatten the bottom of the belly. Pleat the chest on back and front.

128



Completed Pekin Duck

