

シオマネキ Fiddler crab

神谷哲史

Model & Diagrams by Kamiya Satoshi

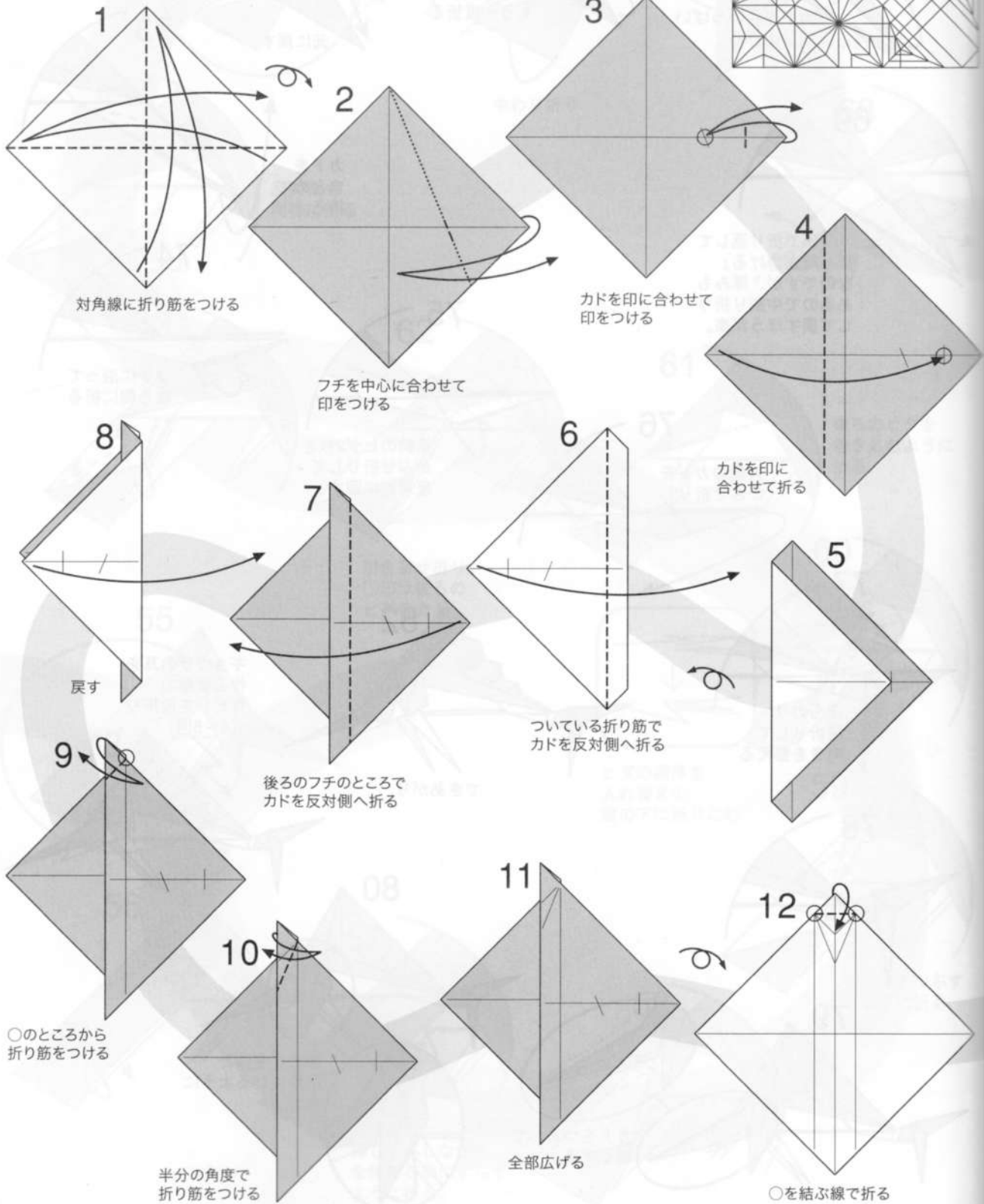

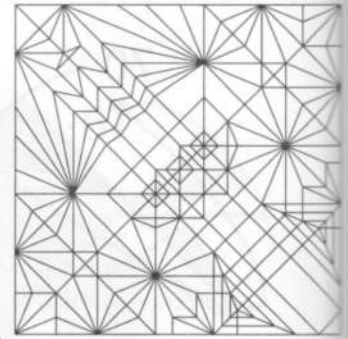
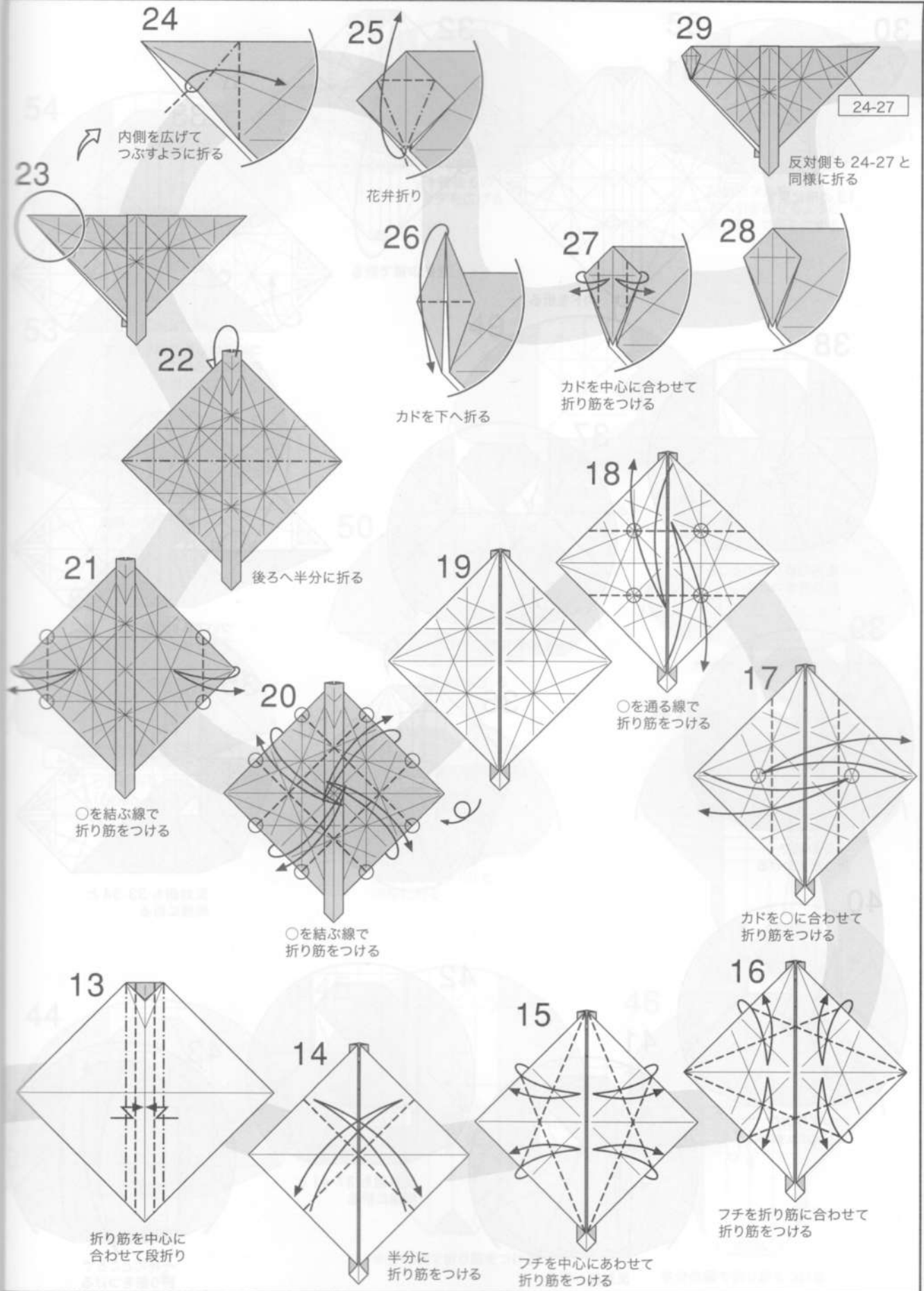

30

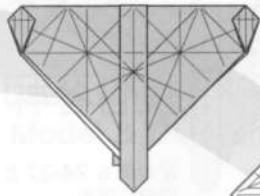

13の形に戻す

31

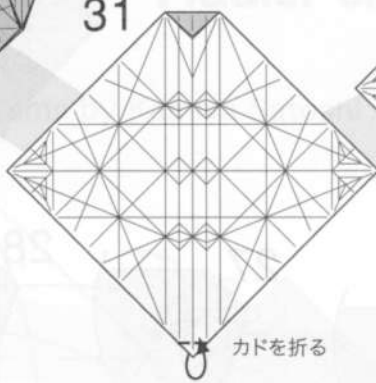

カドを折る

32

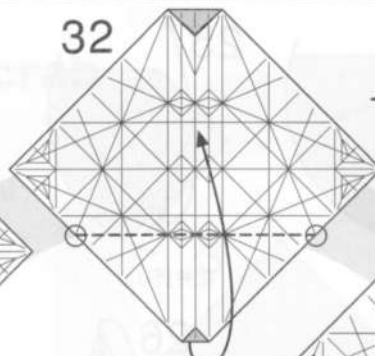

○を結ぶ線で折る

33

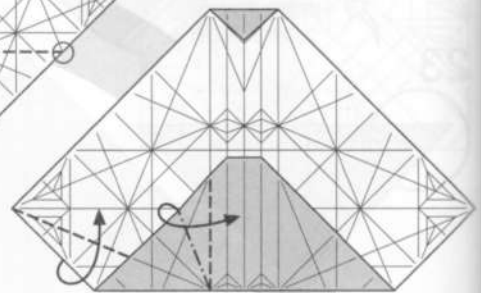

ついている折り筋を使って
内側をひろげて
つぶすように折る

38

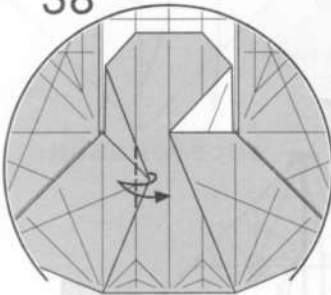

後ろの折り筋のところ
折り筋をつける

37

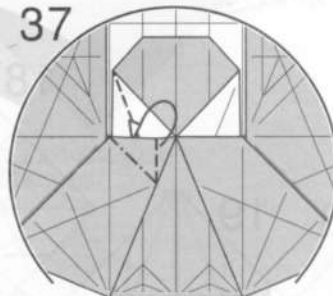

フチを内側に折り込む

34

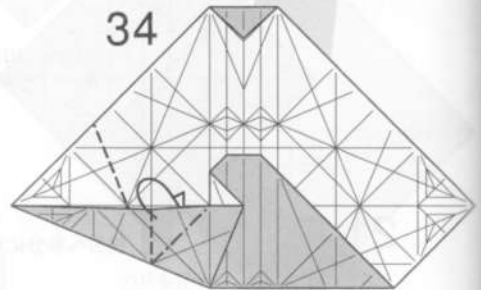

ついている折り筋で
フチを後ろへ折り込む

39

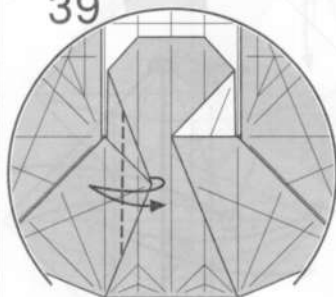

半分の幅で
折り筋をつける

36

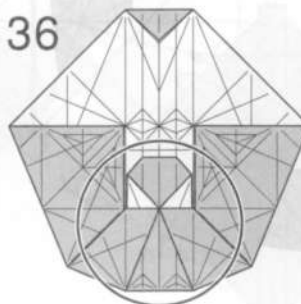

35

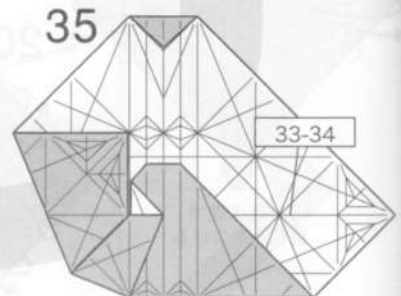

反対側も 33-34と
同様に折る

40

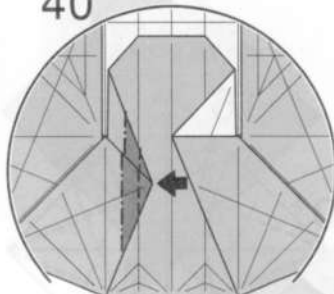

しずめ折り
(Open sink)

41

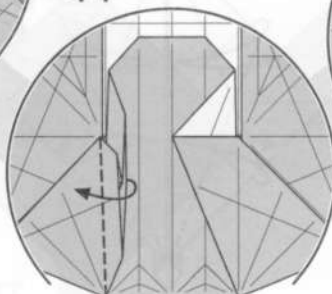

反対側へ折る

42

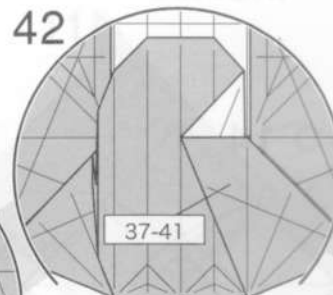

反対側も 37-41と
同様に折る

43

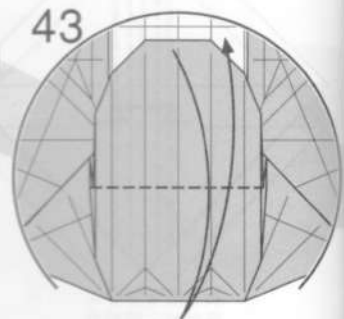

一杯のところで
折り筋をつける

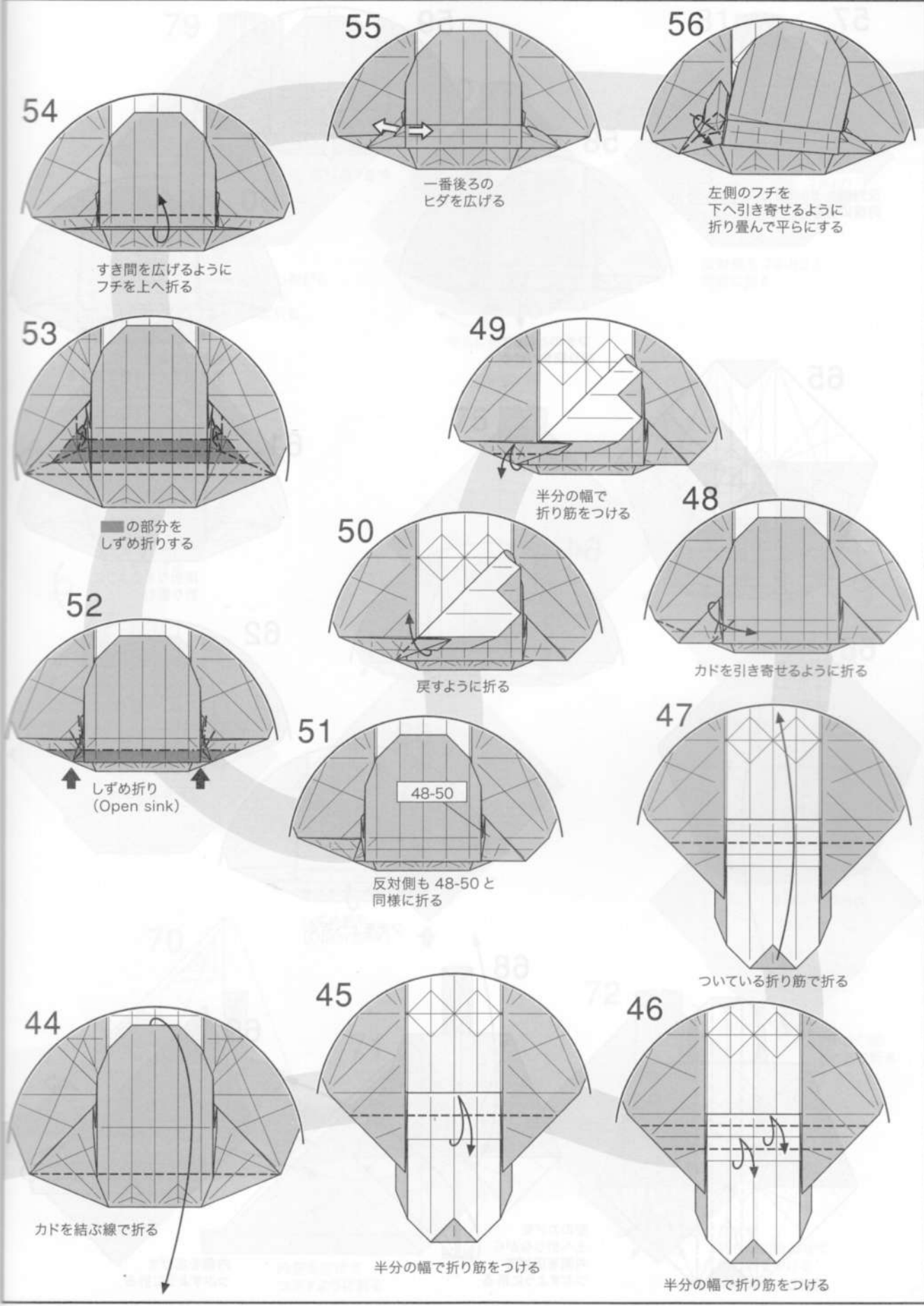

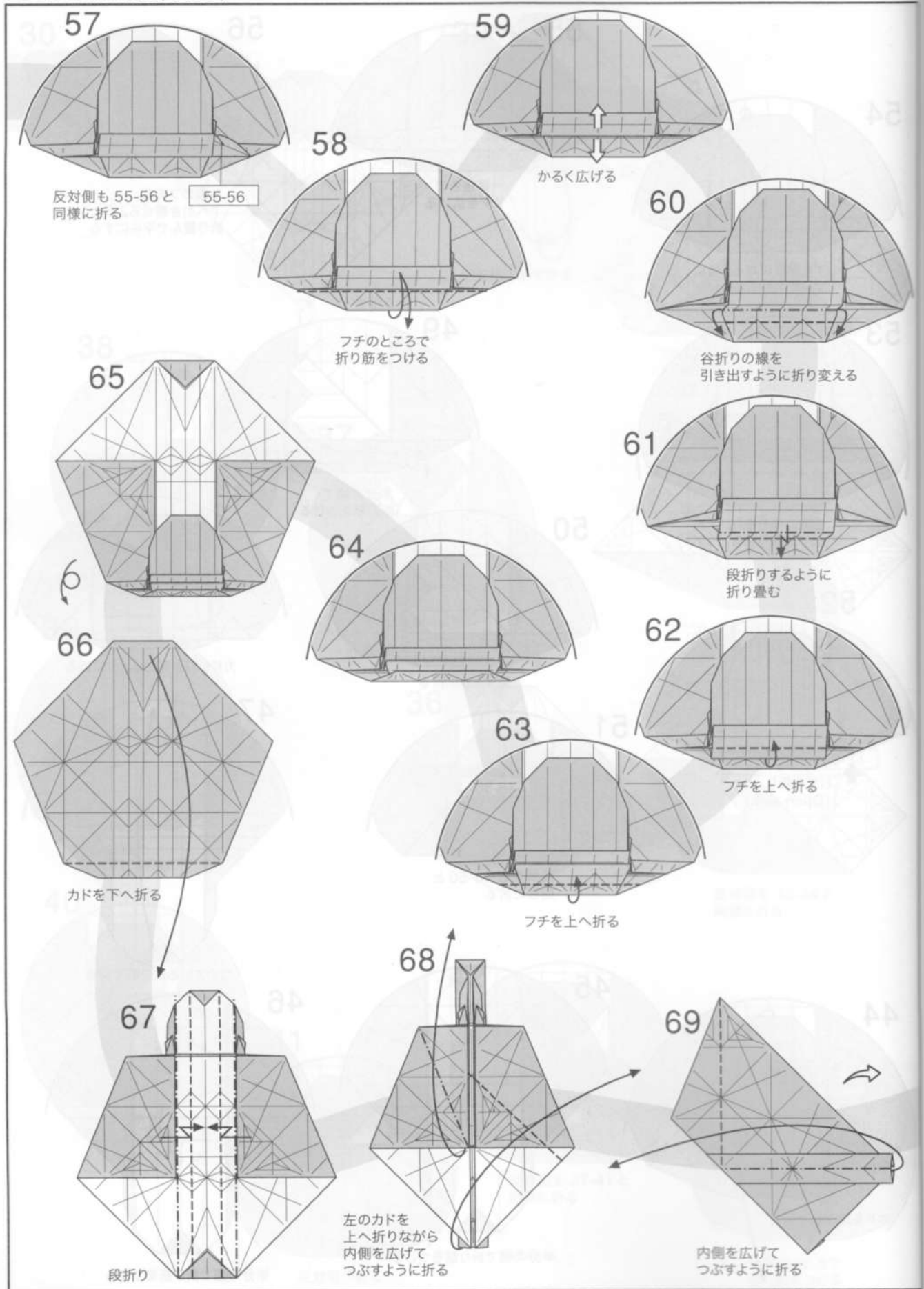

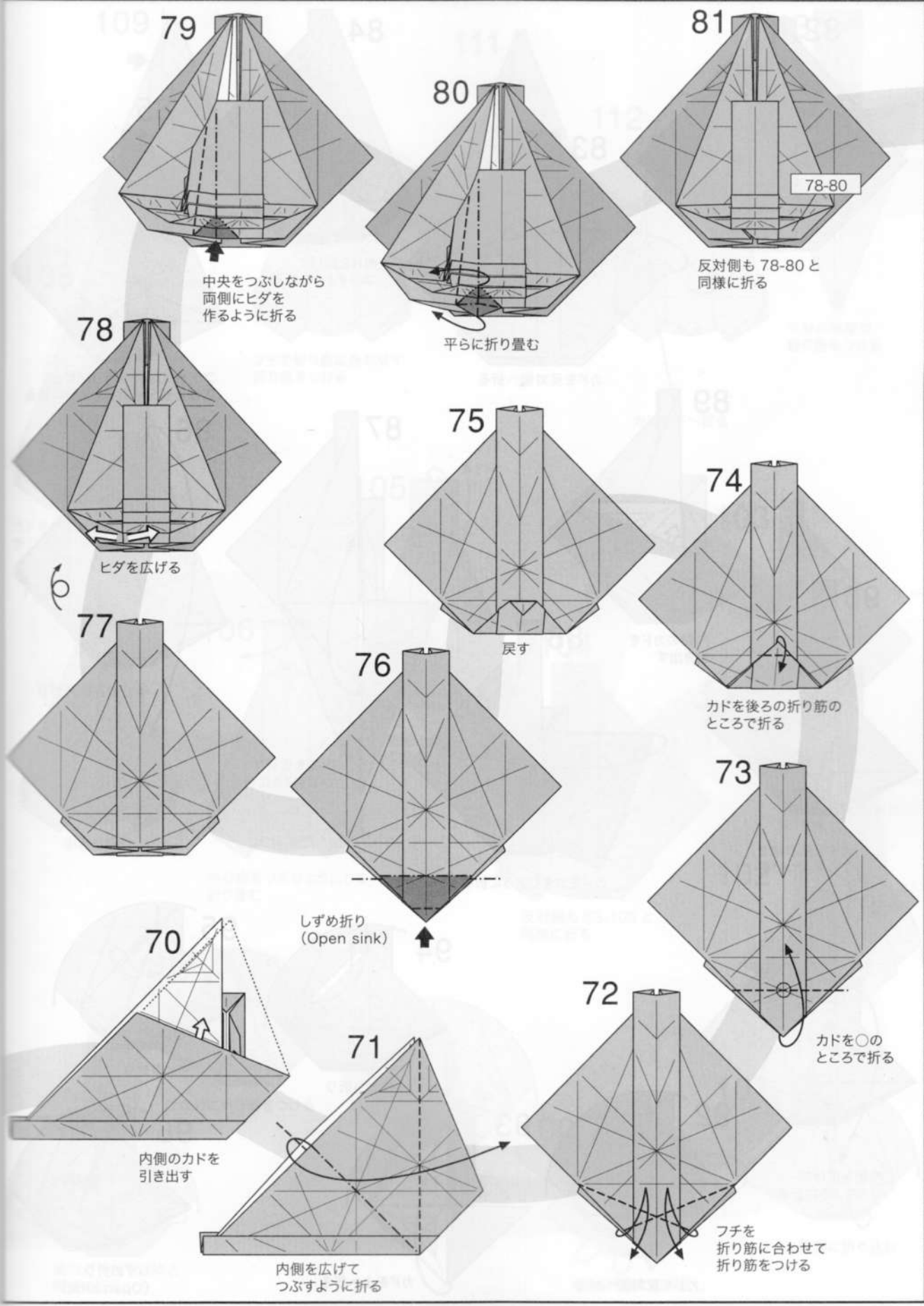

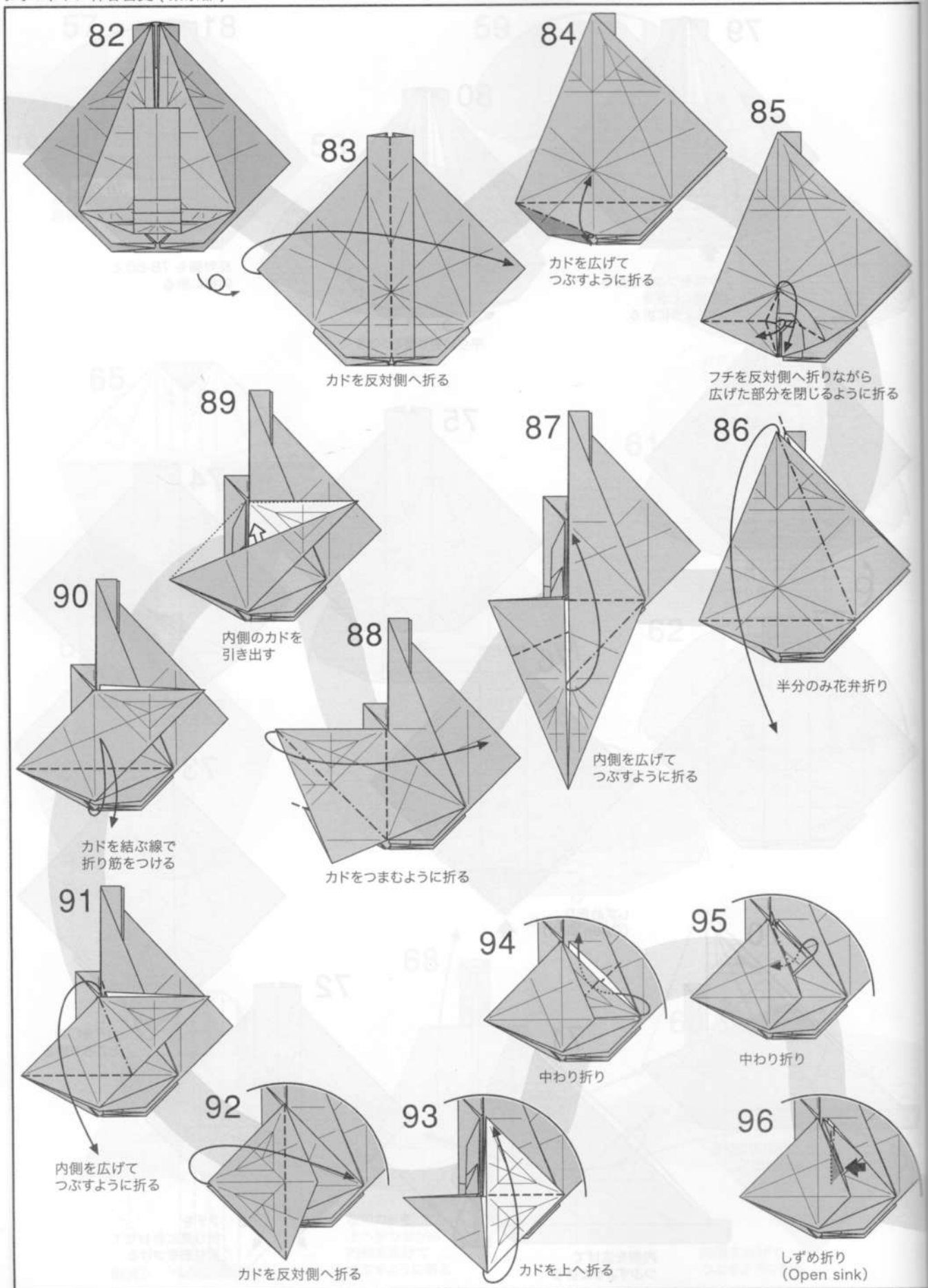

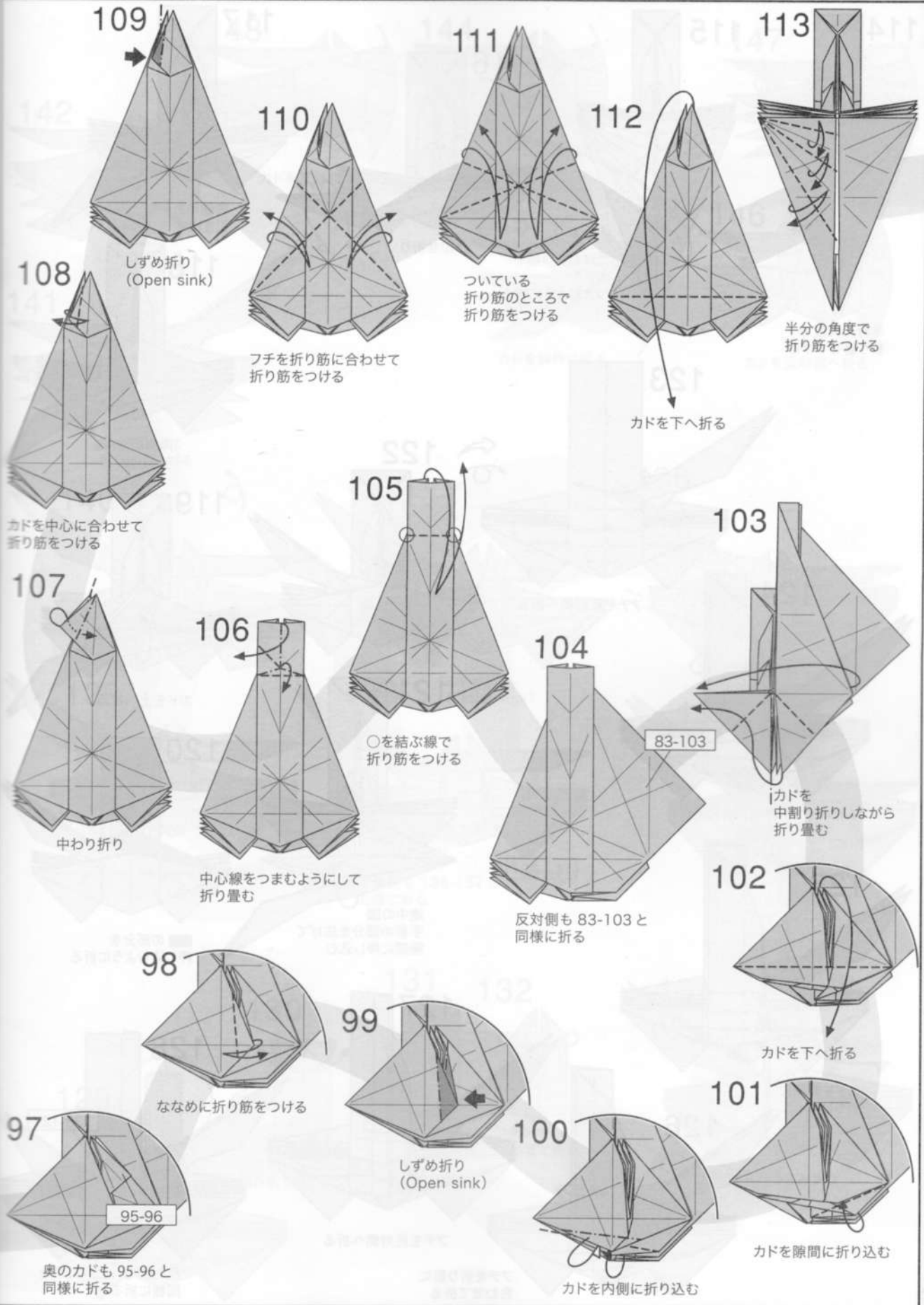

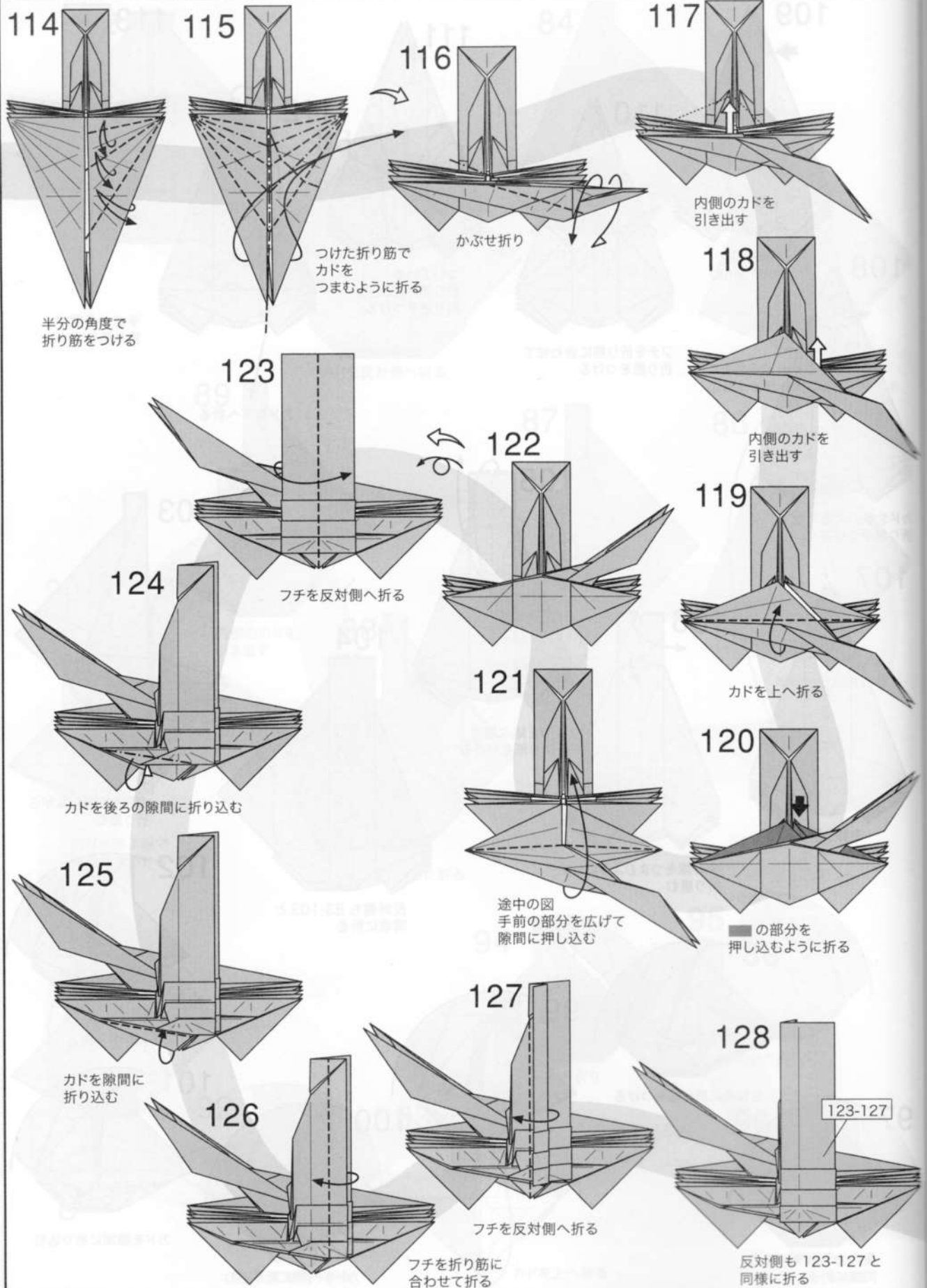

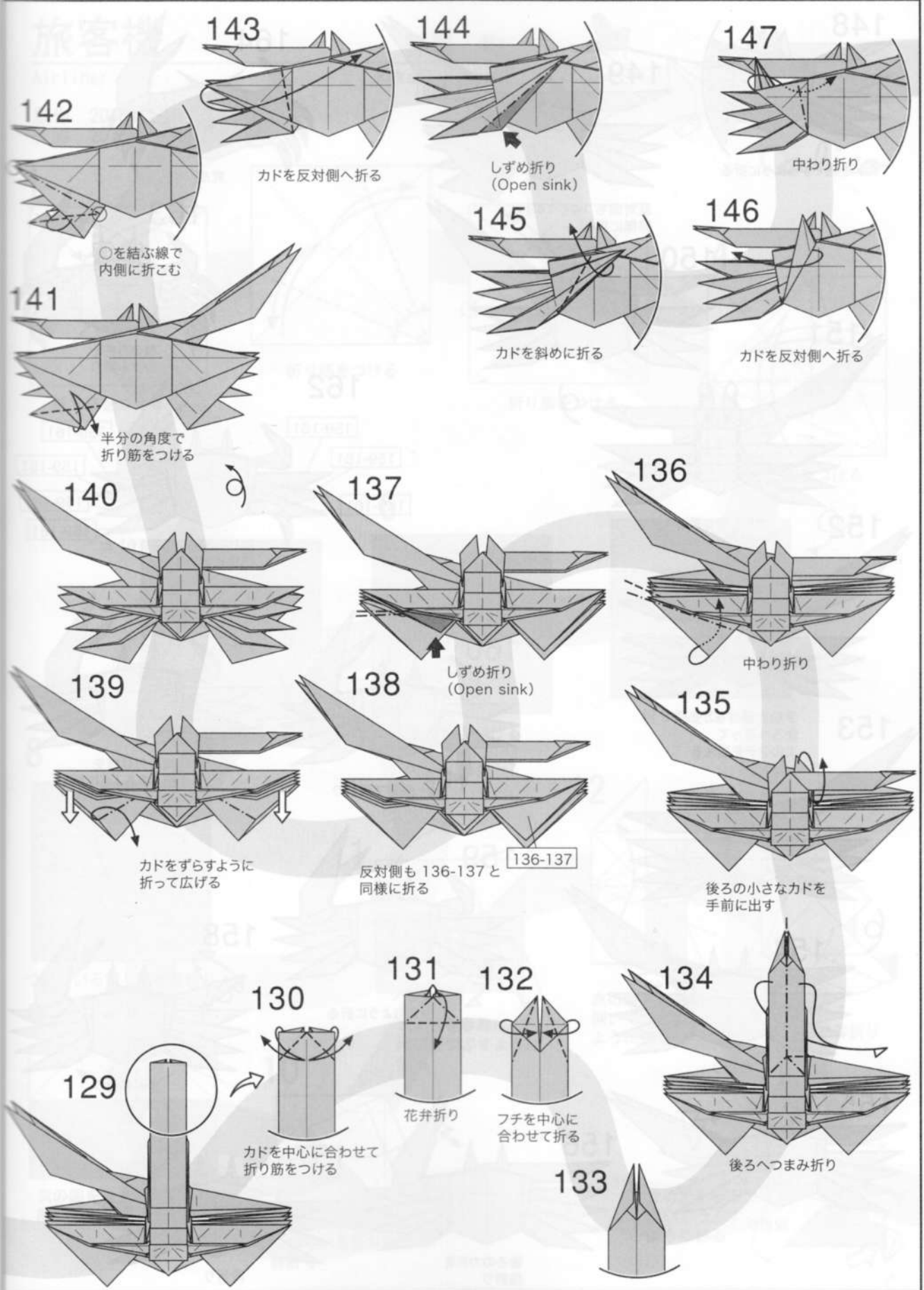

148

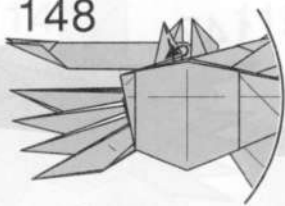

カドを細くするように折る

149

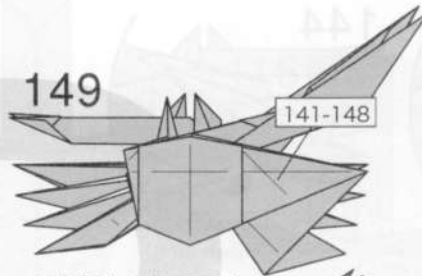

反対側も 141-148 と同様に折る

164



完成

163



目のカドをつまみ折り

150

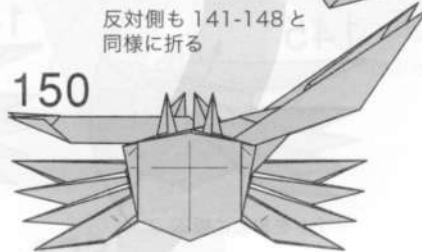

151

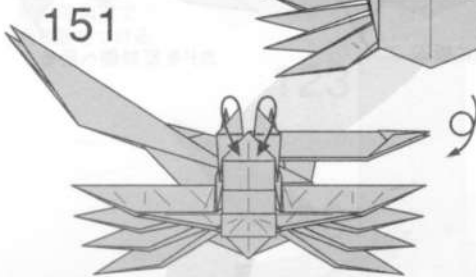

カドを少し折る

162



残りの脚も 159-161 と同様に折る

152

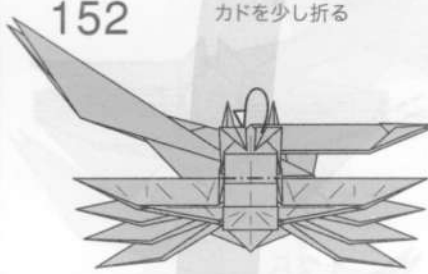

手前の部分をかかく後ろへ折って上のフチを揃える

160



両側で段折り

161

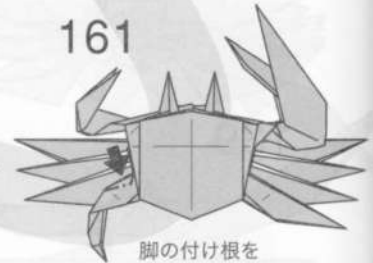

脚の付け根を細くするように折る

153

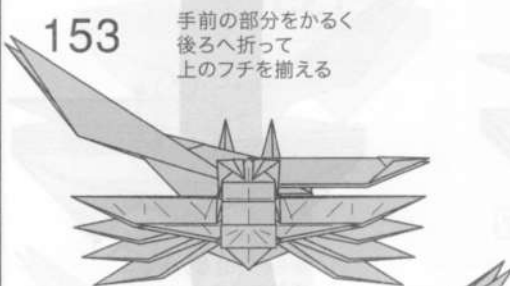

159



後ろへつまむように折る

158

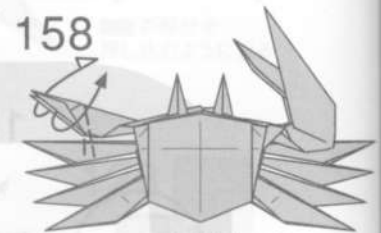

かぶせ折り

154

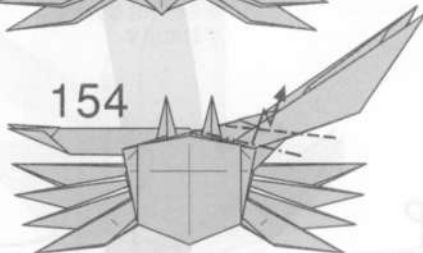

段折り

155

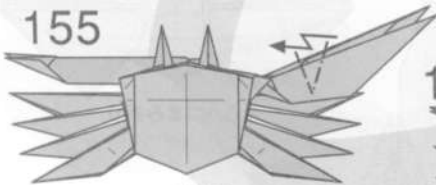

段折り

156

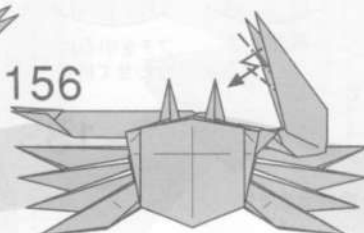

後ろのカドを段折り

157

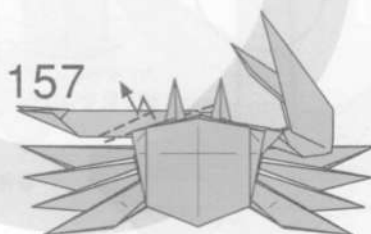

段折り