

# HAMBURGER - TOFU-BURGER (2001)

By: Charles (Not Ground Chuck) Esseltine

Paper required: 2 Brown (Buns), 1 Yellow (Cheese)  
1 Dark Brown / Gray (Hamburger/Tofu Paddy),  
Optional Colors: 2 Green (Pickle & Lettuce), 1 Red  
and/or White (Tomato and/or Onion)

1.) Precrease radially into 16 segments.  
In layman's terms, crease it horizontally,  
vertically, diagonally, and then fold all the  
segments in half.

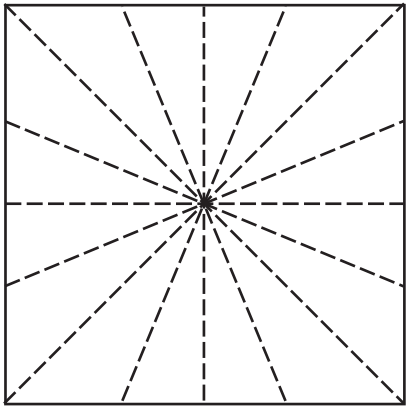

2.) Using the lines as guides, fold the  
corners to the colored side.

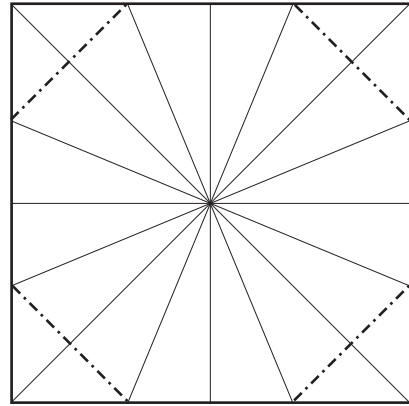

3.) Fold, and unfold the edge to the center.  
repeat on all the edges.

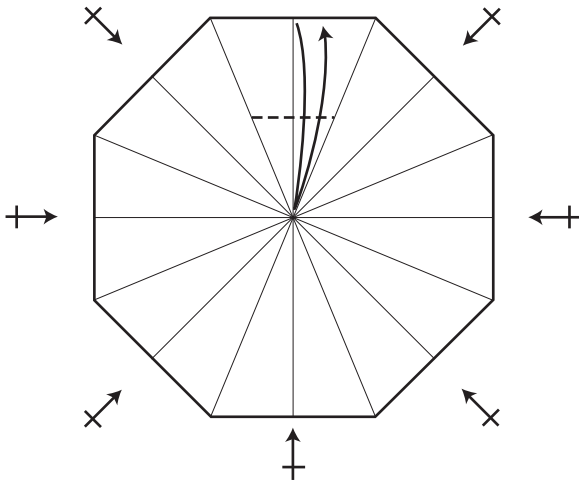

4.) Fold that section in half. Repeat  
on all sides again.

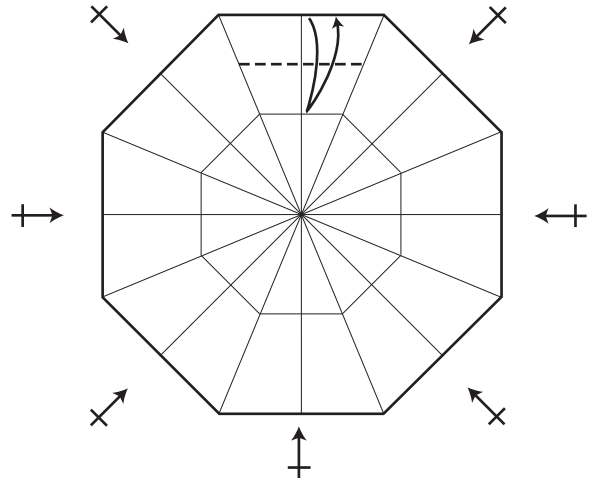

5.) Fold and unfold the edges into the centerline  
of each side, but only on the outer sections.  
Repeat on all sides.

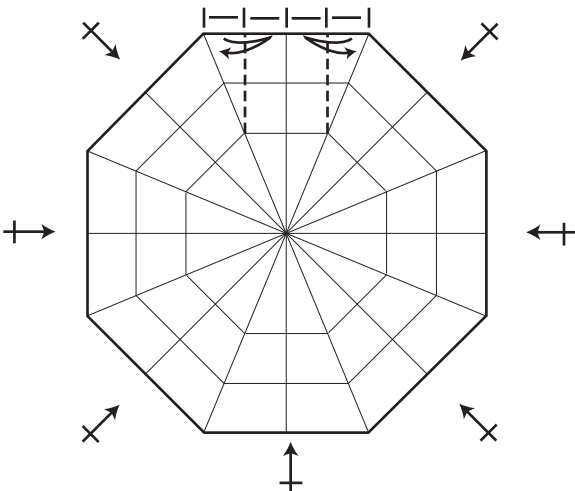

6.) Fun time! Fold into a box shape, by pulling  
in the edges along the creases. Needless to say  
the model is no longer flat.

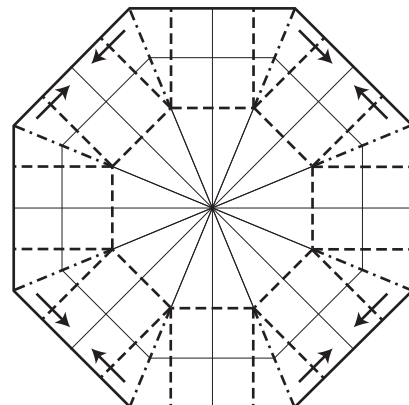

7.) This is what the 'Box' should look like.

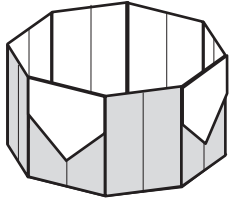

8.) Fold the tips of the white flaps up to the top.

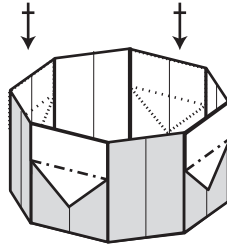

9.) Fold the edge inside the model.

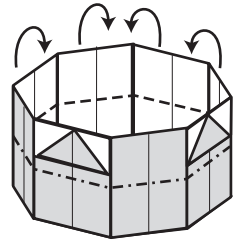

10.) Fold the flaps up to form a ledge. Repeat steps 1 to 10 for the bottom.

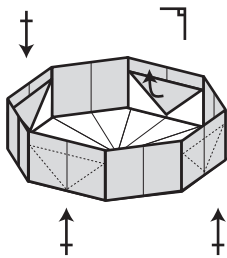

THE BUNS ARE DONE

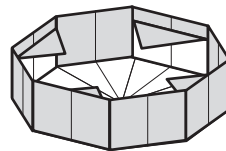
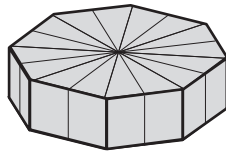

While Duo-colored paper is the best, you can substitute with two layers of paper, colored sides out.

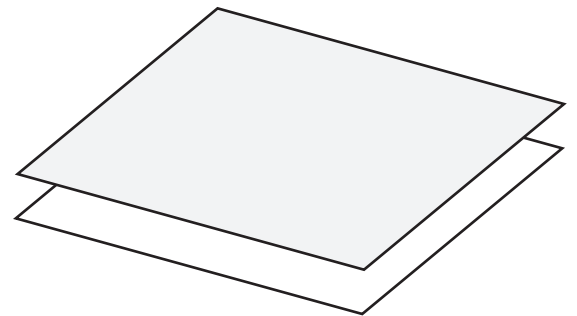

11.) Along the diagonal, horizontal, and vertical centerlines fold and unfold the two layers (Or Duo-color paper)

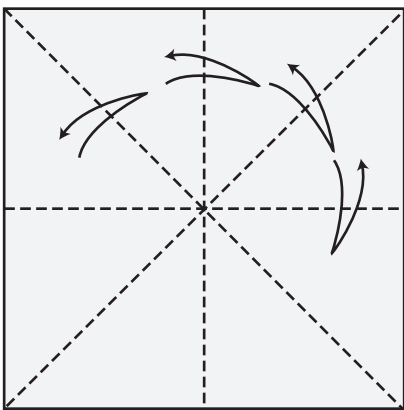

12.) If you are using duo-color blintz and skip to step 16. If you are using two layers blintz the top layer.

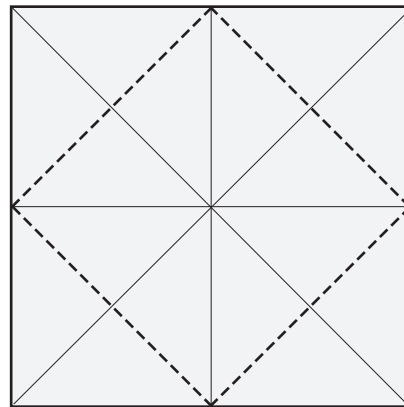

13.) Fold the tips of the bottom layer to meet the blintzed edges of the top layer.

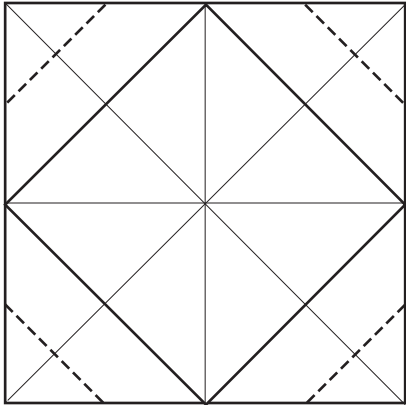

14.) Fold the bottom layer to match the top.

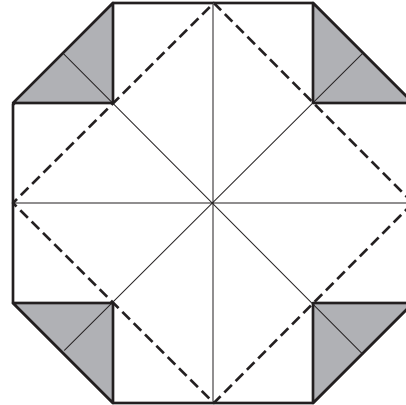

15.) Flip over, and rotate.

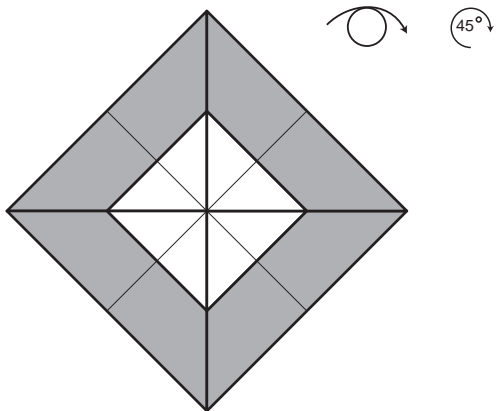

16.) Blintz and unfold. (UNBLINTZ?)

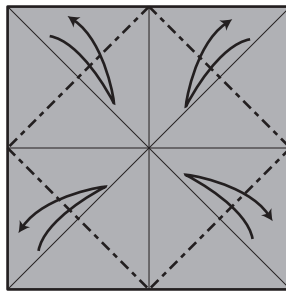

17.) Fold, and unfold into fourths both ways.

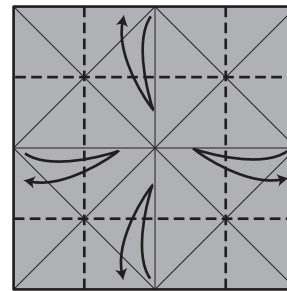

18.) Fold, and unfold the outer sections into eighths both ways.

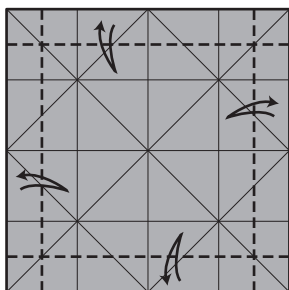

19.) Using the existing creases as guides, fold the corners together.

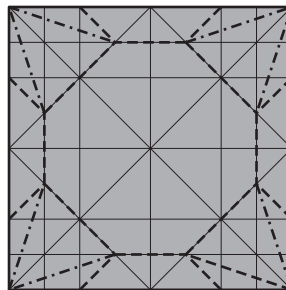

20.) Tuck the corner points inside the edge. Flip over.

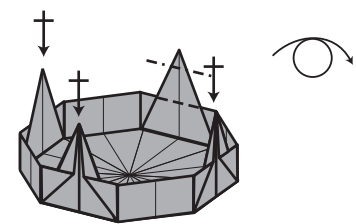

20.) Tuck the corner points inside the edge. Flip over.

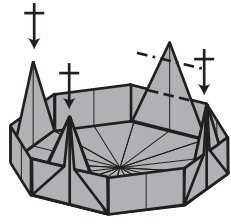

21.) If you used two pieces unfold the inner layer's points to form the cheese. If you used duo-colored paper just unblintz the top layer.

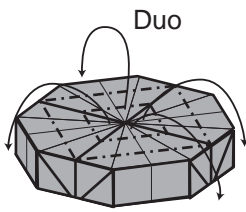
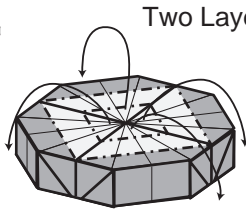

BURGER'S DONE!

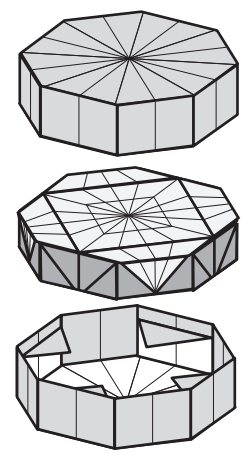

22.) PICKLES! Start by folding a preliminary base. All the extras are from paper that is half the size used for the burger, and buns. So let's zoom in a little.

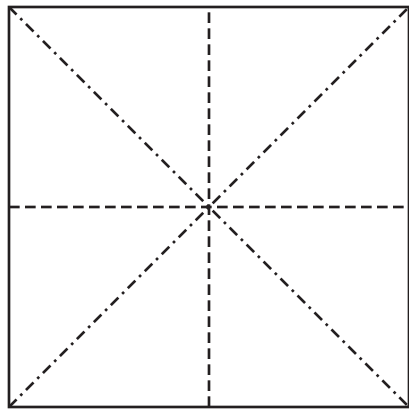

23.) Fold and unfold the corners to taste. Repeat on the back. Then unfold.

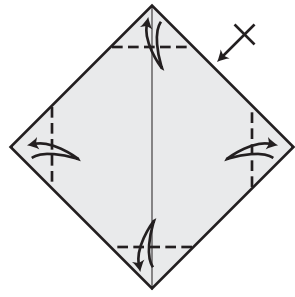

BUT WAIT! Something's missing!

24.) Refold the preliminary base.

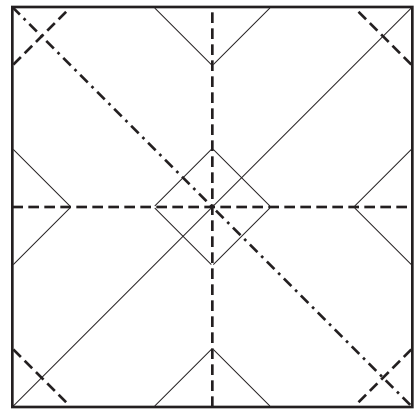

25.) Sink the top. And reverse fold all four corners.

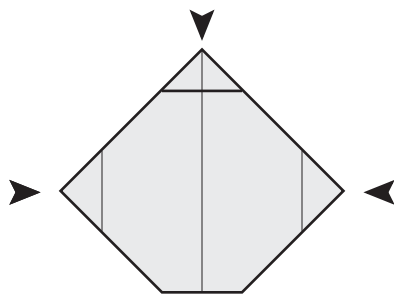

26.) Pleat fold through all the layers. You don't have to be neat. Partially flatten the model.

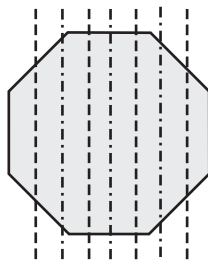

27.) Swivel the top, and bottom layers. Again you don't have to be neat. Crease the inner layers gently.

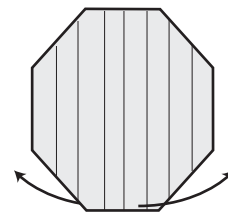

PICKLES ARE DONE

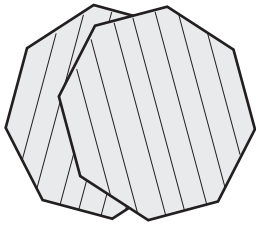

28.) ONIONS AND TOMATOES ! Start by folding a red bun and a white bun from papers that are smaller than the ones you used for the buns. Then fold the edges in half again.

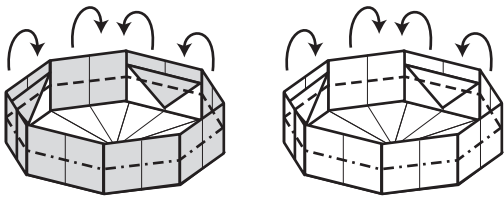

IS THE BURGER DONE YET?

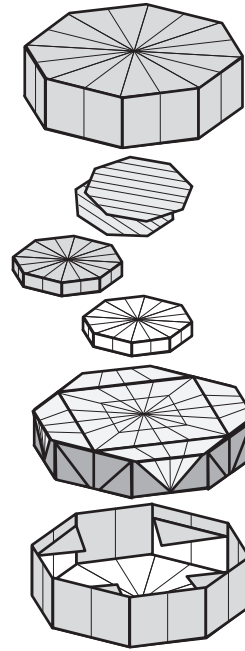

ALMOST! Only one thing is still missing!

29.) LETTUCE! Take the neatest piece of light green you can find, and artistically crumple it into a ball. Then artistically unfold it, but leave it artistically crumpled.

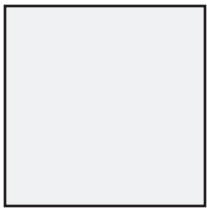

30.) Round to taste.

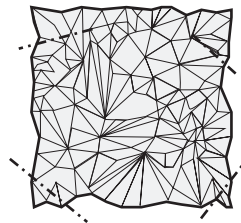

THE LETTUCE! Now let us see how the lettuce looks on the burger.

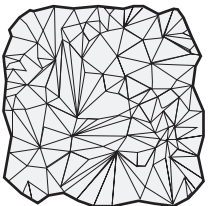

WELL! IS THE BURGER DONE?

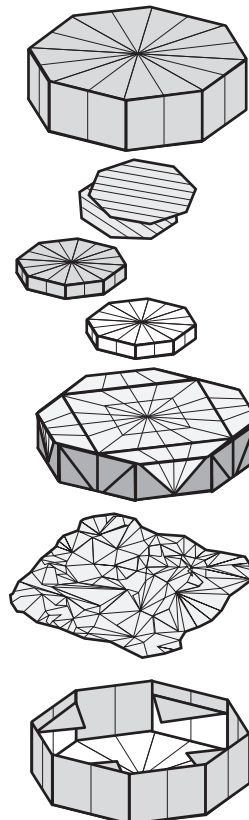

It's WELL DONE, or at least it's DONE WELL!

