

FAVORITE ANIMALS IN ORIGAMI

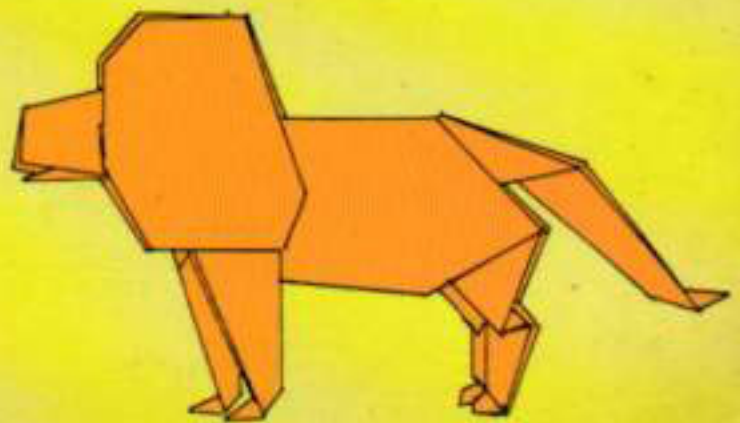
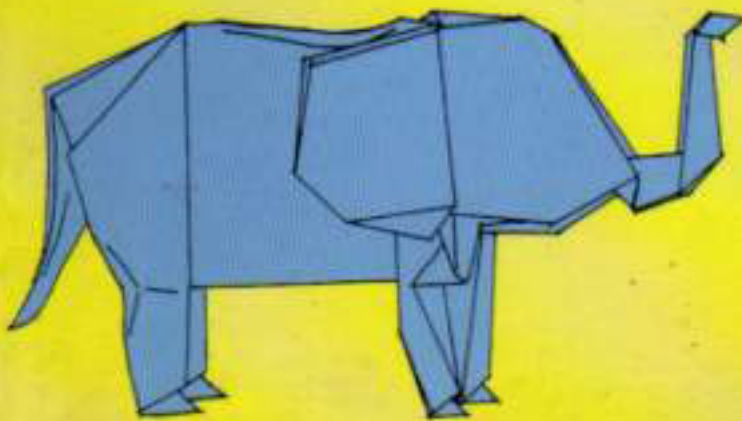
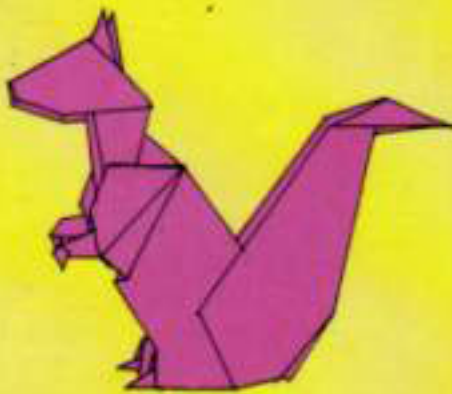
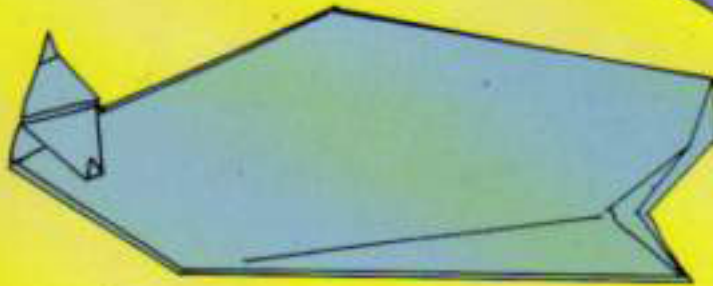
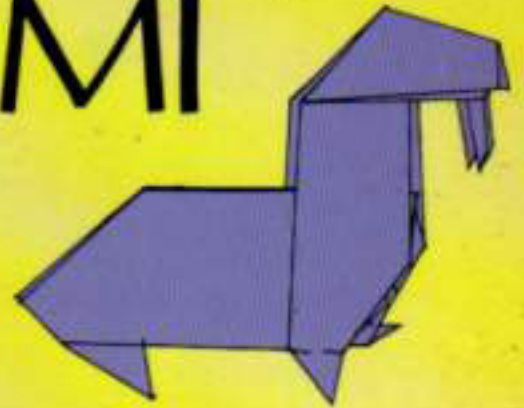

John Montroll

FAVORITE ANIMALS IN ORIGAMI

John Montroll



DOVER PUBLICATIONS, INC.
Mineola, New York

Copyright

Copyright © 1996 by John Montroll.
All rights reserved under Pan American and International Copyright Conventions.

Published in Canada by General Publishing Company, Ltd., 30 Lesmill Road, Don Mills, Toronto, Ontario.

Published in the United Kingdom by Constable and Company, Ltd., 3 The Lanchesters, 162-164 Fulham Palace Road, London W6 9ER.

Bibliographical Note

Favorite Animals in Origami is a new work, first published by Dover Publications, Inc. in 1996.

Library of Congress Cataloging-in-Publication Data

Montroll, John.
Favorite animals in origami / John Montroll.
p. cm.
ISBN 0-486-29136-7 (pbk.)
1. Origami. 2. Animals in art. I. Title.
TT870.M555 1996
736'.982—dc20

96-14937
CIP

Manufactured in the United States of America
Dover Publications, Inc., 31 East 2nd Street, Mineola, N.Y. 11501

Introduction

Of all the possible models to fold, mammals are among my favorites. Here is a collection of a dozen mammals ranging in skill level from intermediate to high-intermediate.

The diagrams follow the internationally approved Randlett-Yoshizawa style, which is easy to follow once you have learned the basic folds. You can use any kind of square paper for these models, but the best results and most precise folding can be achieved using standard origami paper, which is colored on one side and white on the other. In these diagrams, the shading represents the colored side. Origami paper can be found in many hobby shops or purchased by mail from Origami USA, a non-profit organization of dedicated paperfolders. For more information about the group, send a self-addressed, business-size envelope with two first-class stamps to:

Origami USA
15 West 77th St.
New York, NY 10024-5192

Origami paper, and a catalog of other available craft books, can also be ordered from Dover Publications, Inc., at:

Dover Publications, Inc.
31 East 2nd St.
Mineola, NY 11501

I hope you enjoy folding these as much as I did creating them.

John Montroll

Contents

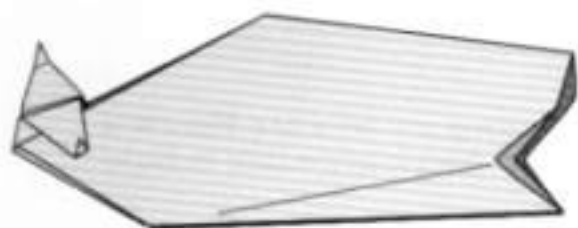

Whale
Page 9

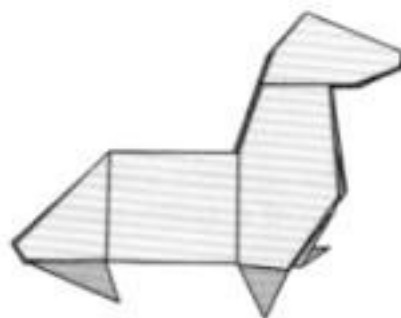

Seal
Page 11

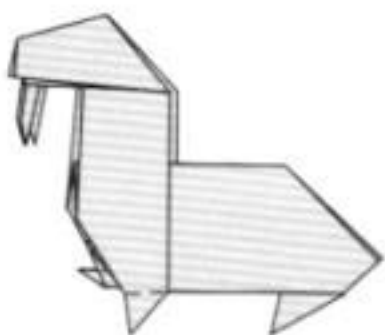

Walrus
Page 14

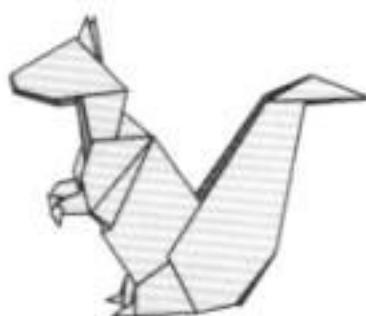

Squirrel
Page 17

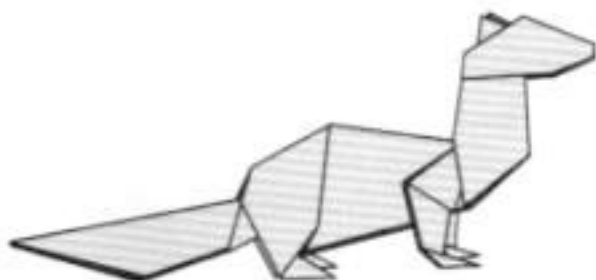

Mink
Page 20

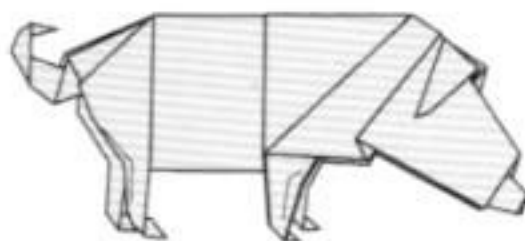

Pig
Page 24

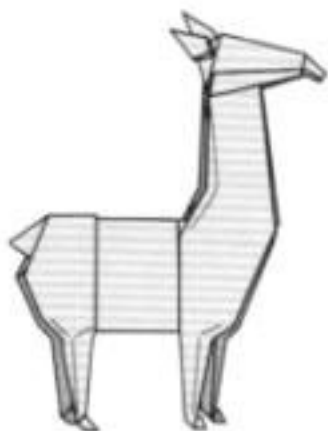

Llama
Page 27



Deer
Page 30

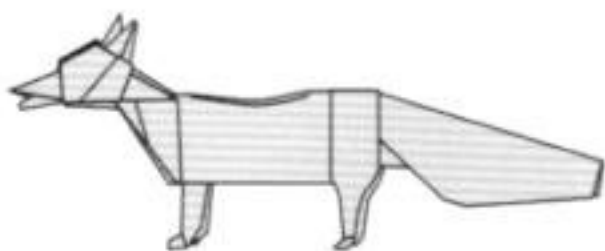

Fox
Page 34

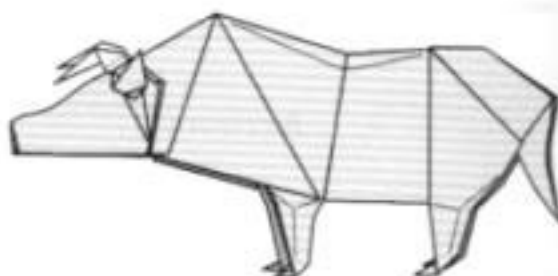

Bull
Page 38

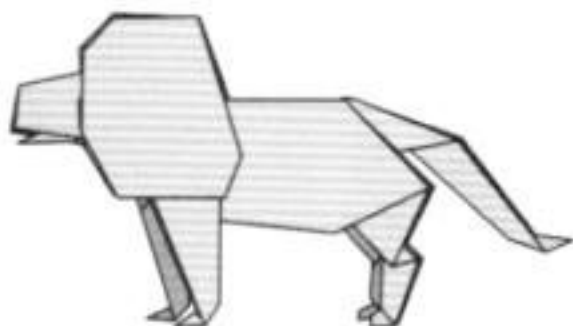

Lion
Page 42

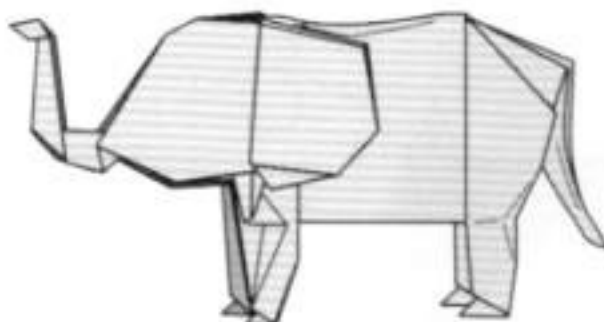

Elephant
Page 45

Symbols

Lines



Valley fold, fold in front.



Mountain fold, fold behind.



Crease line.



X-ray or guide line.

Arrows



Fold in this direction.



Fold behind.



Unfold.



Fold and unfold.



Turn over.



Sink or three dimensional folding.



Place your finger between these layers.

Basic Folds

Rabbit Ear.

To fold a rabbit ear, one corner is folded in half and laid down to a side.

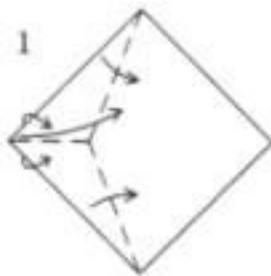

Fold a rabbit ear.

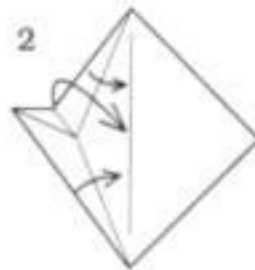

A three-dimensional intermediate step.

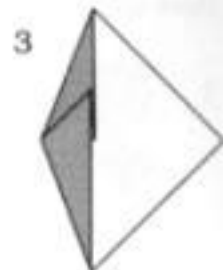

Double Rabbit Ear.

If you were to bend a straw you would be folding the double rabbit ear.

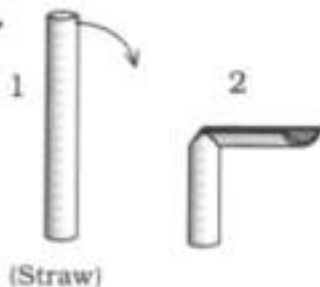

(Straw)



Make a double rabbit ear.

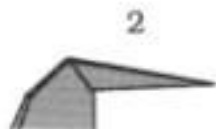

Squash Fold.

In a squash fold, some paper is opened and then made flat. The shaded arrow shows where to place your finger.

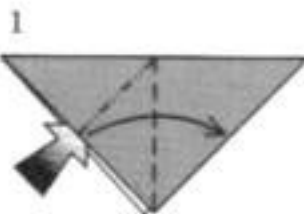

Squash-fold.

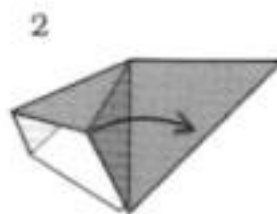

A three-dimensional intermediate step.

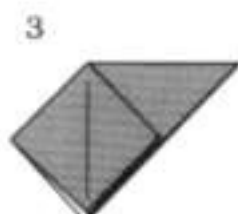

Petal Fold.

In a petal fold, one point is folded up while two opposite sides meet each other.

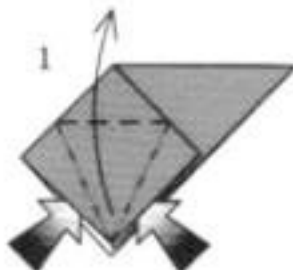

Petal-fold.

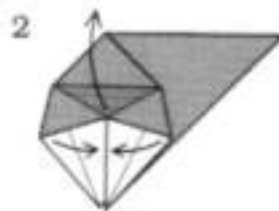

A three-dimensional intermediate step.

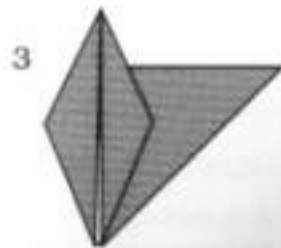

Inside Reverse Fold.

In an inside reverse fold, some paper is folded between layers. Here are two examples.



1

Reverse-fold.



2



1

Reverse-fold.



2

Outside Reverse Fold.

Much of the paper must be unfolded to make an outside reverse fold.

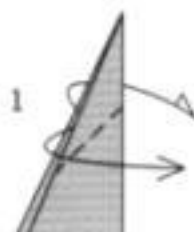

1



2

Outside-reverse-fold.

Crimp Fold.

A crimp fold is a combination of two reverse folds.

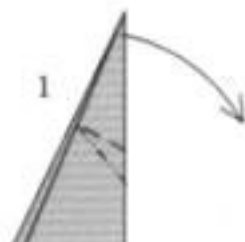

1

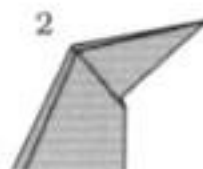

2

Crimp-fold.

Sink Fold.

In a sink fold, some of the paper without edges is folded inside. To do this fold, much of the model must be unfolded.

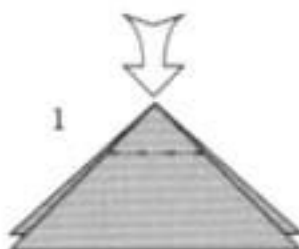

1

Sink.



2

Spread Squash Fold.

A cross between a squash fold and a sink fold; some paper in the center is spread apart and then made flat.



1

Spread-squash-fold.



2

Whale

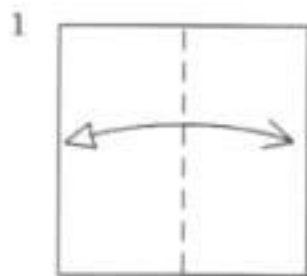
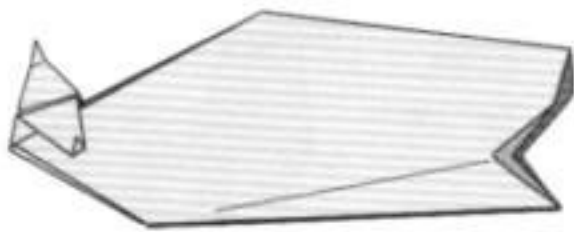

Fold and unfold.

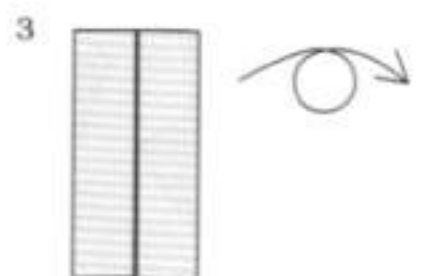
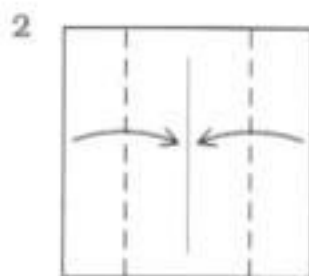

Fold the corner to the center line.

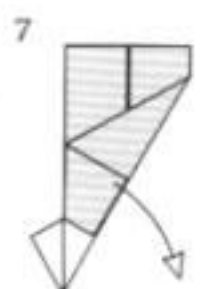

Unfold.

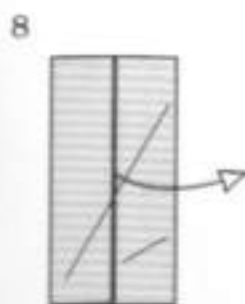

Unfold.

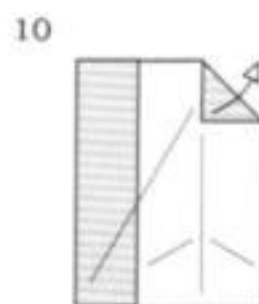
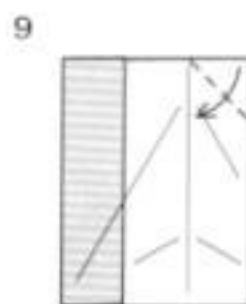

Unfold.

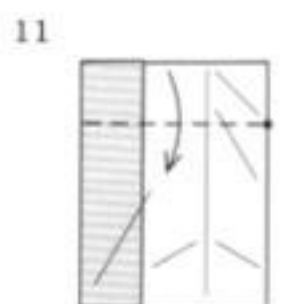

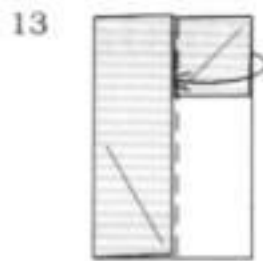
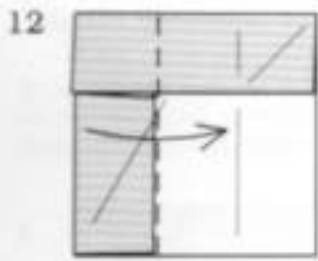

Tuck inside.

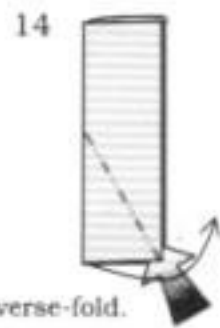

Reverse-fold.

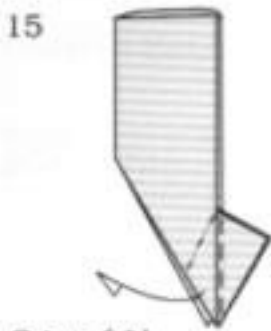

Crimp-fold.



Rotate.



Tuck all the layers together.

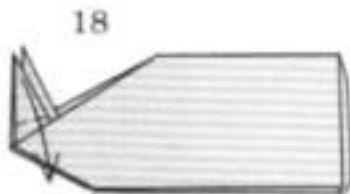

Repeat behind.

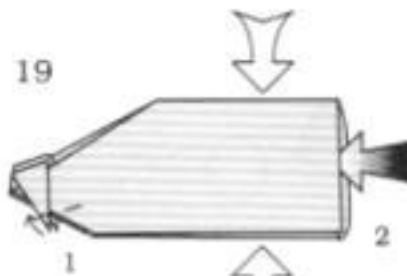

1. Repeat behind.
2. Open the whale.



Form a three-dimensional mouth.

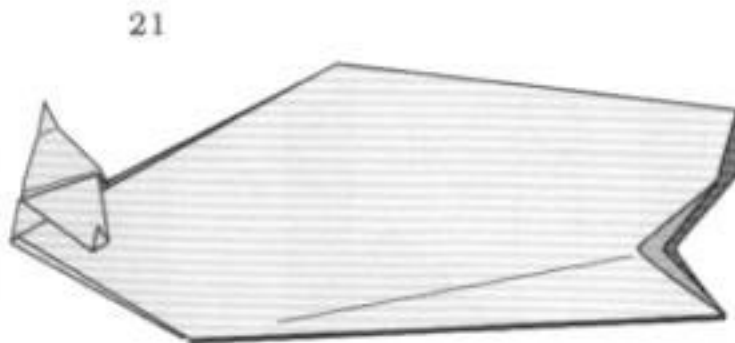

Whale

Seal

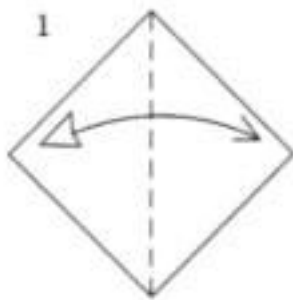
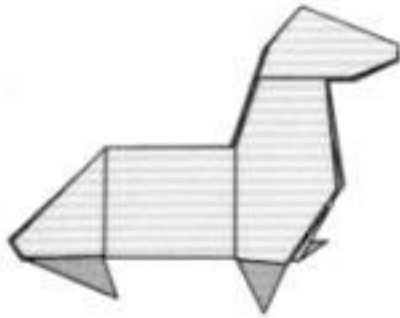

Fold and unfold
along the diagonal.

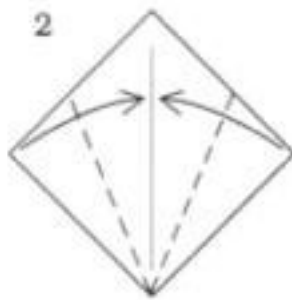

Kite-fold.

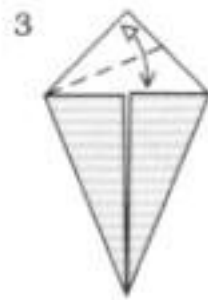

Fold and unfold.

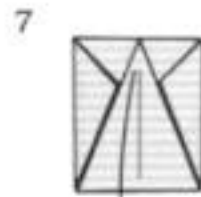
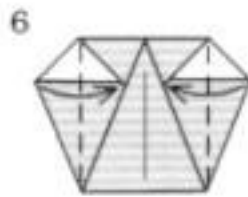
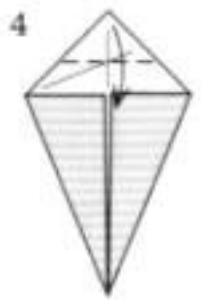

Unfold.



Unfold.

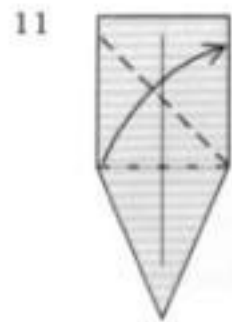
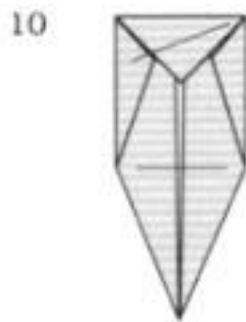

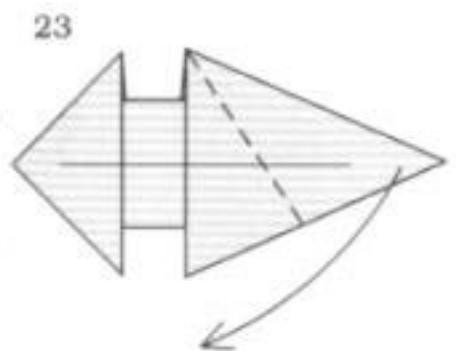
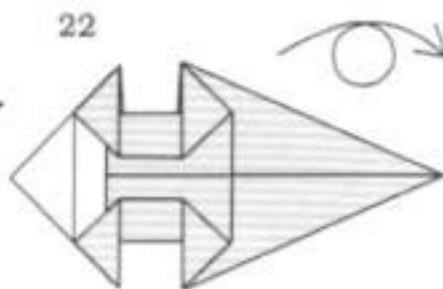
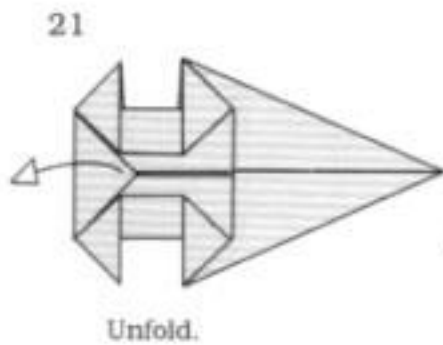
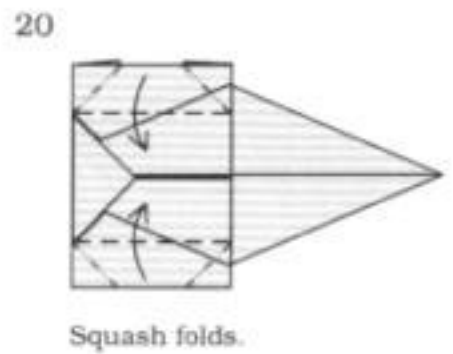
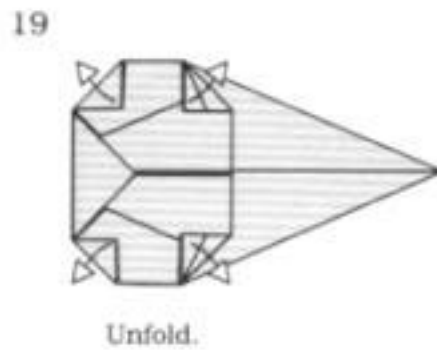
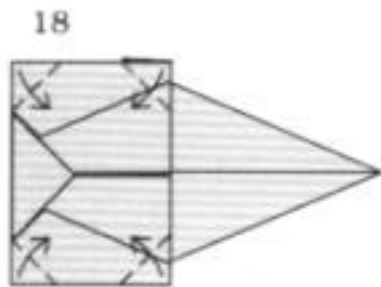
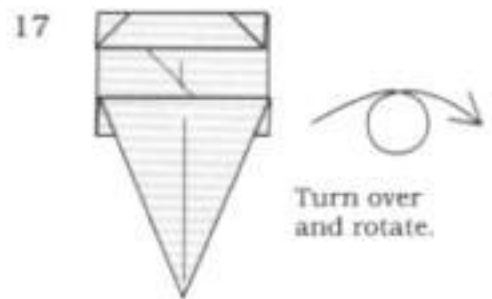
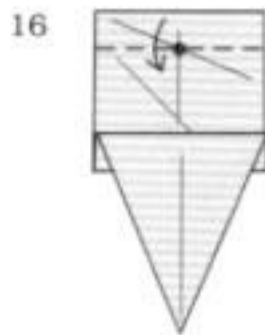
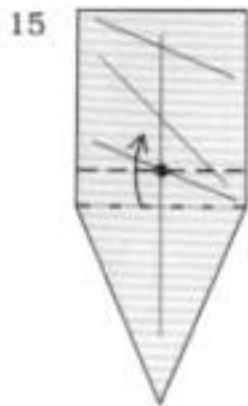
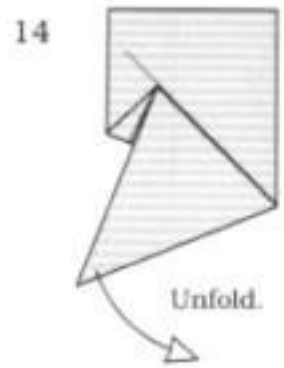
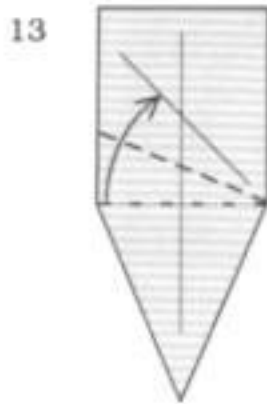
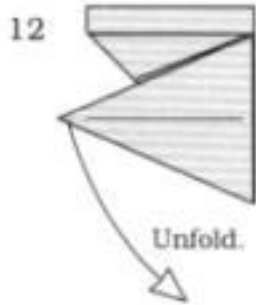

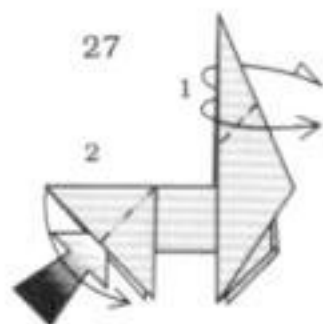
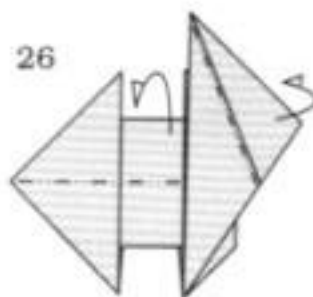
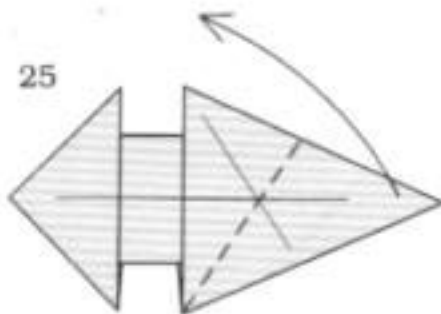
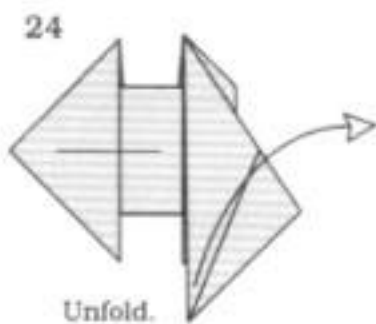

1. Outside-reverse-fold.
2. Reverse-fold.

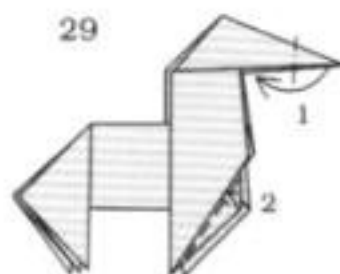
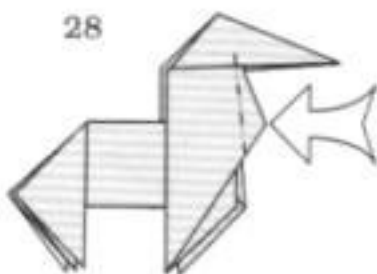

1. Reverse-fold.
2. Tuck inside, repeat behind.

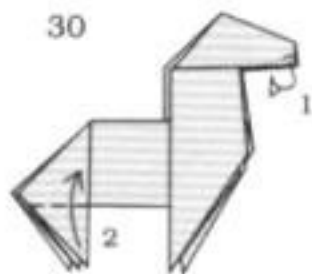

Repeat behind.

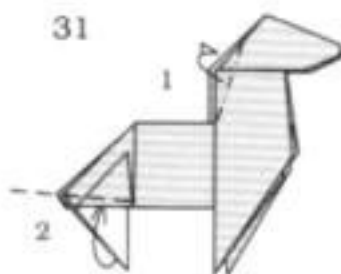

1. Repeat behind.
2. Tuck inside.



Fold the legs out,
repeat behind.

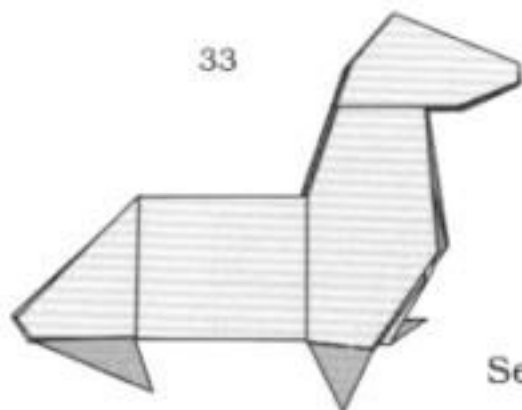

Seal

Walrus

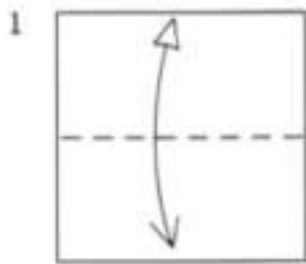
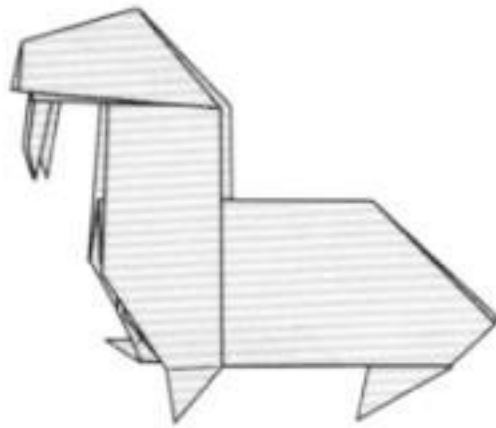

Fold and unfold.

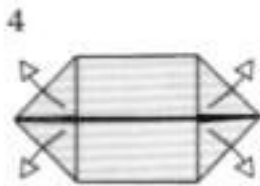
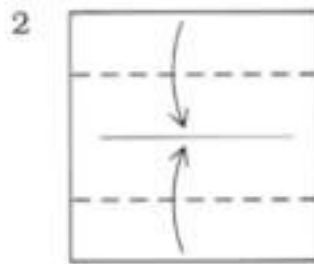

Unfold.

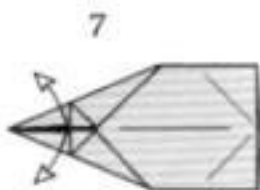
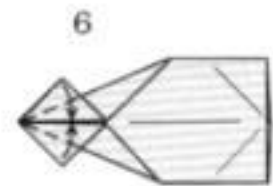

Unfold.



Reverse-fold.

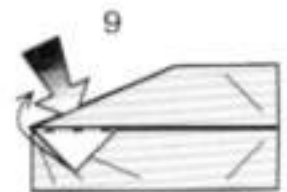

Reverse-fold.

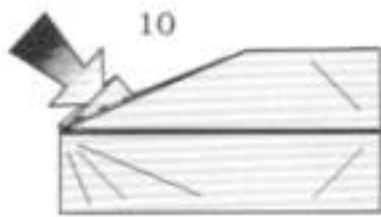

Reverse-fold.

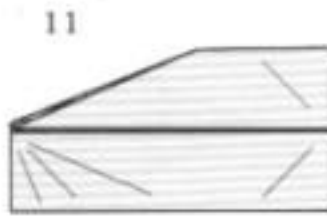

Repeat steps
8-10 below.

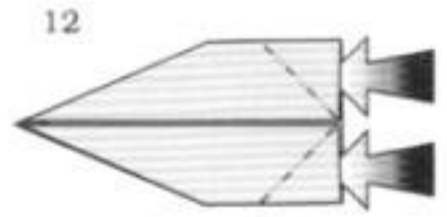

Reverse folds.

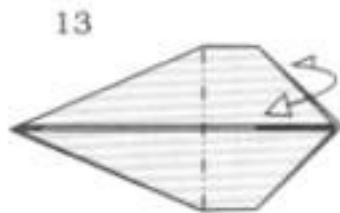

Fold and unfold.

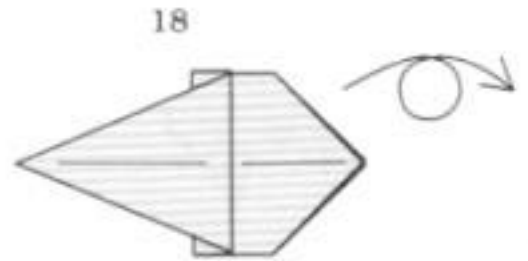
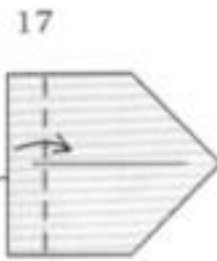
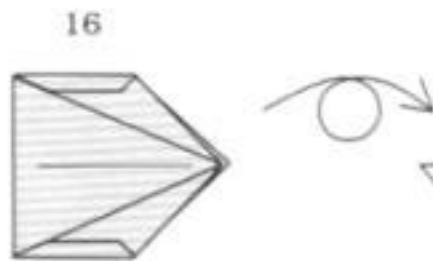
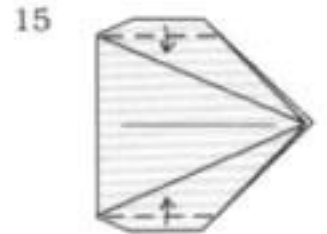
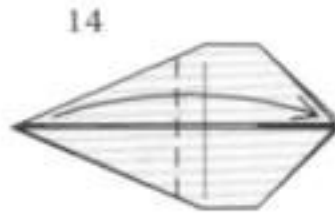

Fold on the crease.

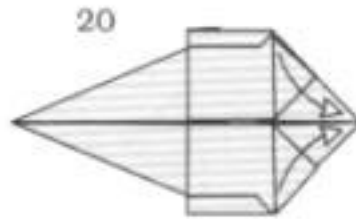
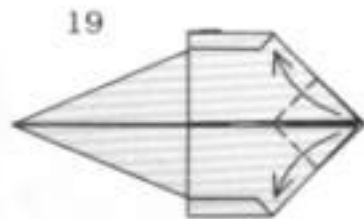

Unfold.

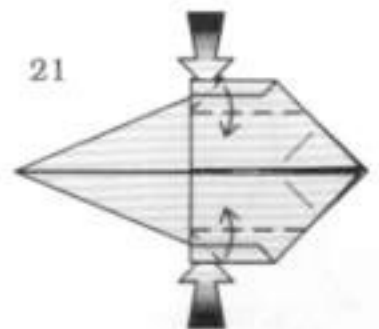

Squash folds.

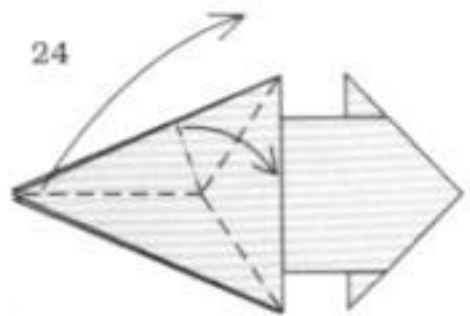
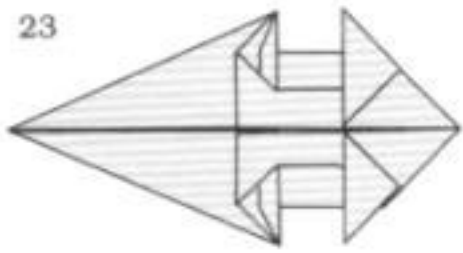
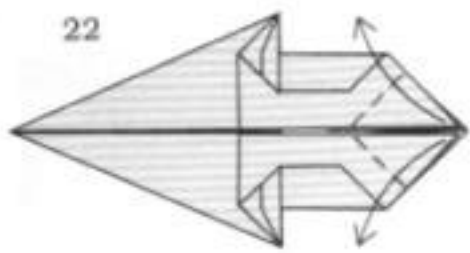

Rabbit-ear.

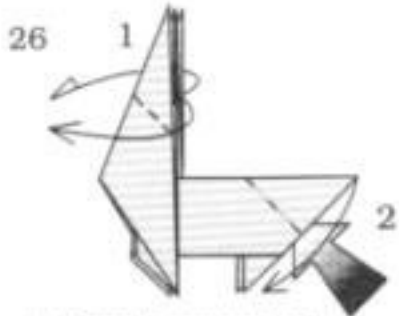
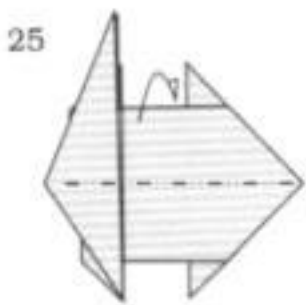

1. Outside-reverse-fold.
2. Reverse-fold.

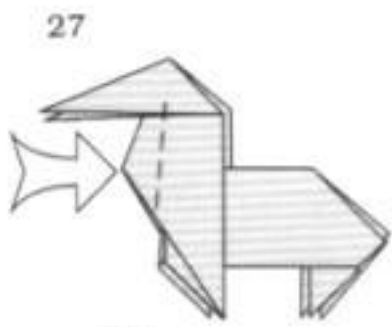

Sink.

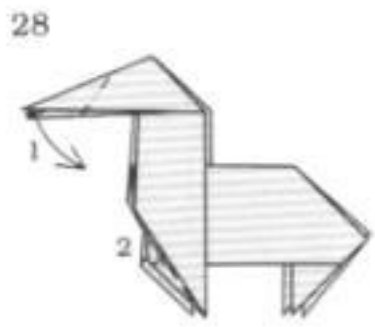

1. Reverse-fold.
2. Tuck inside.
Repeat behind.

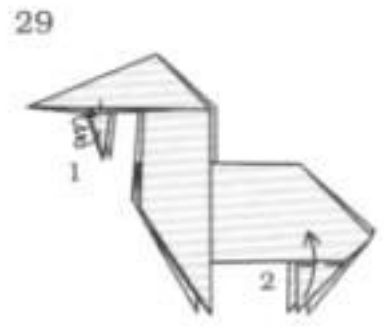

Repeat behind.

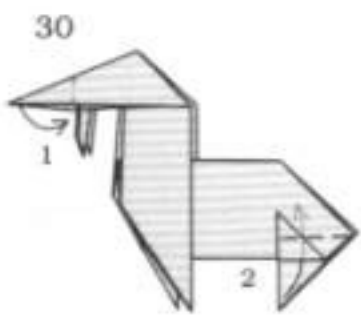

1. Reverse-fold.
2. Tuck inside.

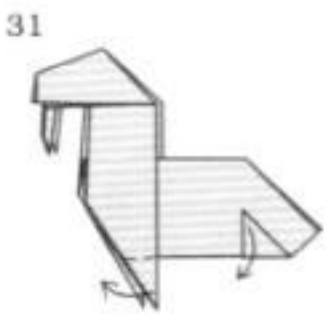

Fold the legs out,
repeat behind.

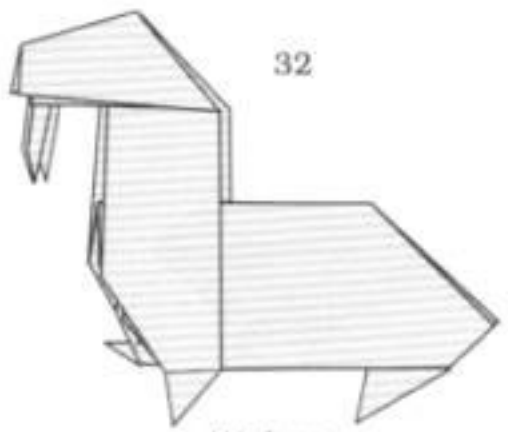

Walrus

Squirrel

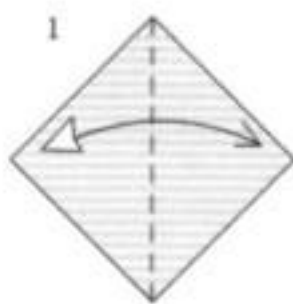
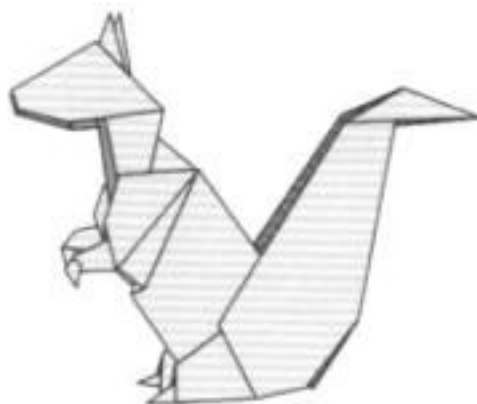

Fold and unfold
along the diagonal.

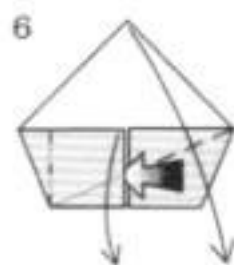
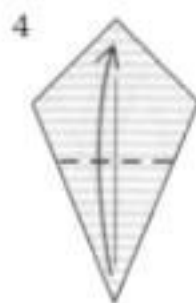
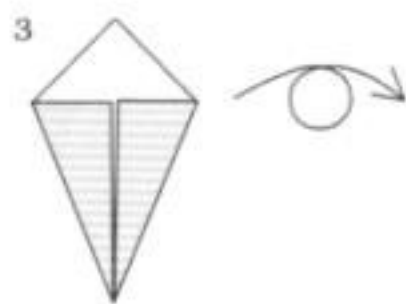
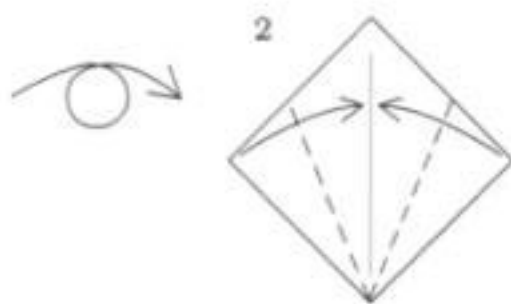

Squash-fold.



Squash-fold.

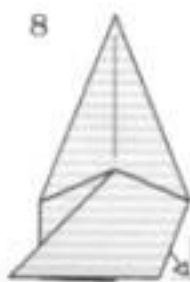

Pull out.

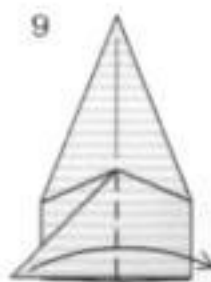

Squash-fold.

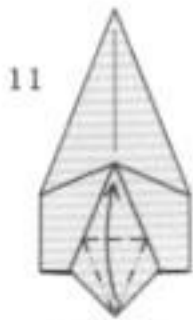

Petal-fold.

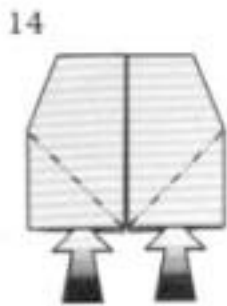
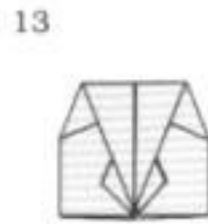
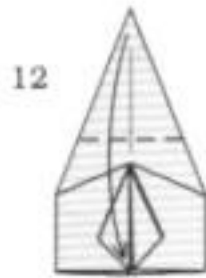

Reverse folds.

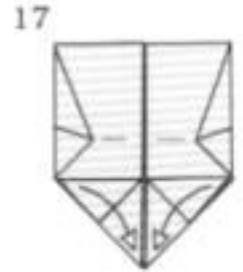
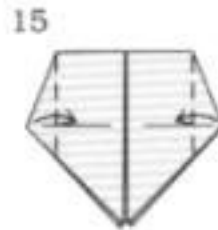

Unfold.

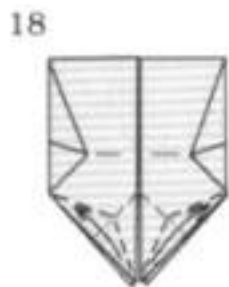

Rabbit ears.

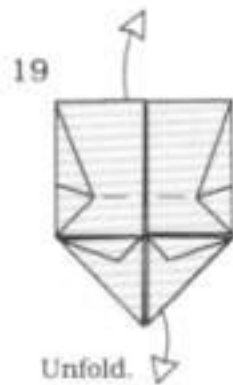

Unfold.

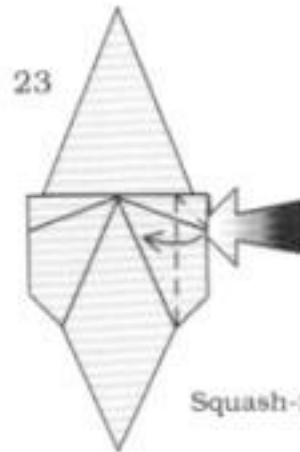
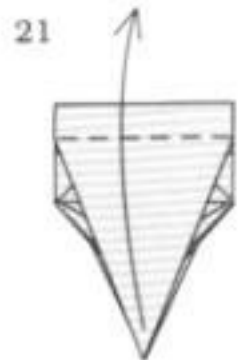
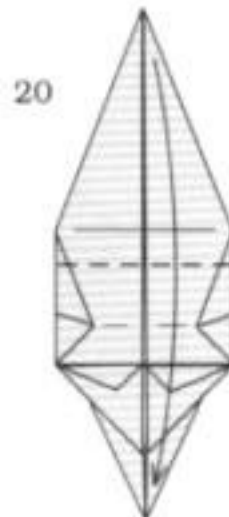

Squash-fold.

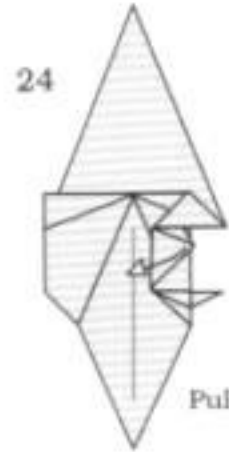

Pull out.

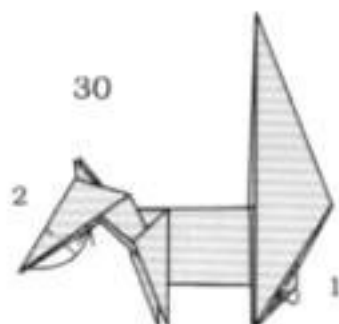
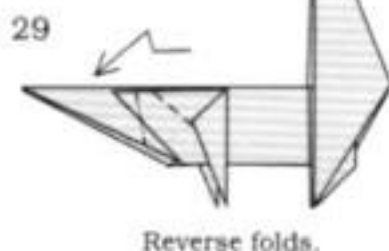
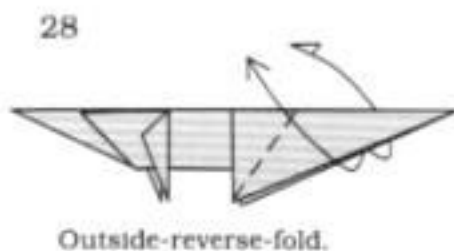
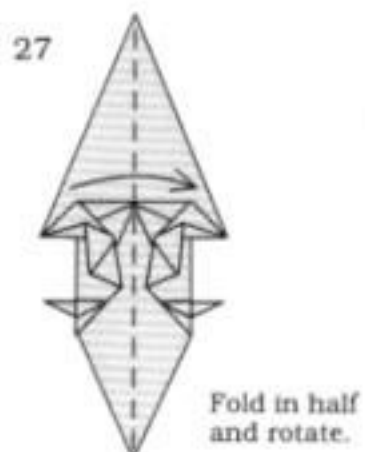
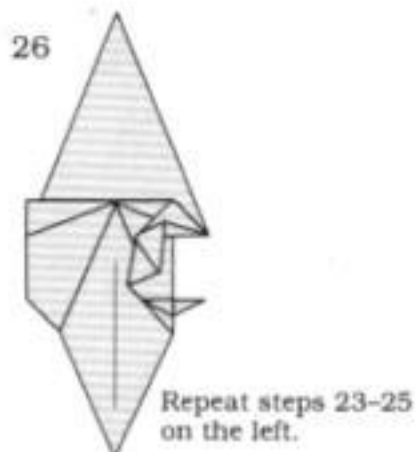
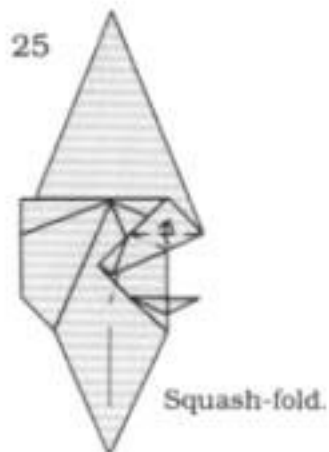

1. Tuck inside, repeat behind.
2. Reverse-fold.

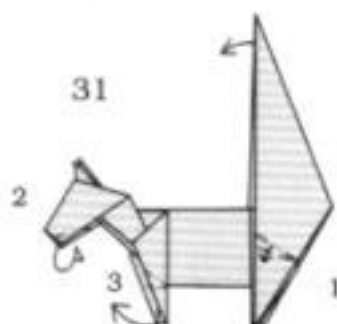

1. Crimp-fold.
2. Mountain-fold.
3. Crimp-fold.
Repeat behind.

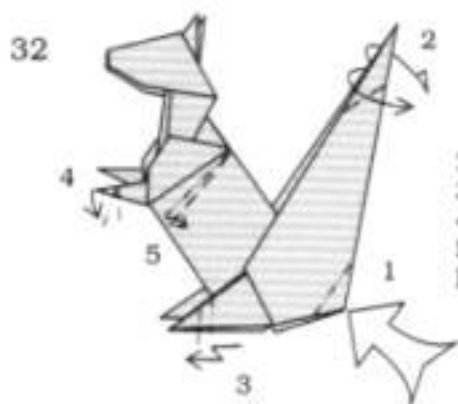

1. Sink.
2. Outside-reverse-fold.
3. Crimp-fold.
4. Squash-fold.
5. Crimp-fold.
Repeat behind.

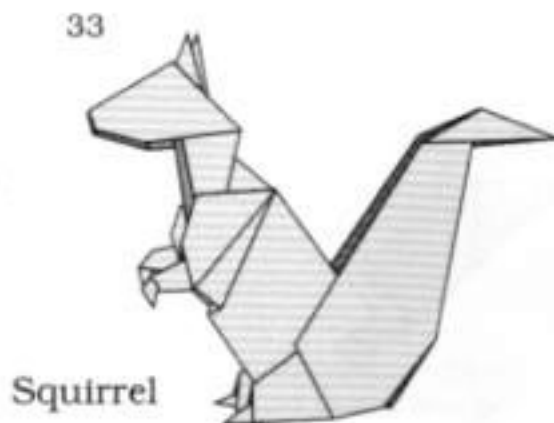

Mink

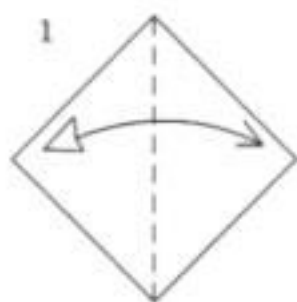
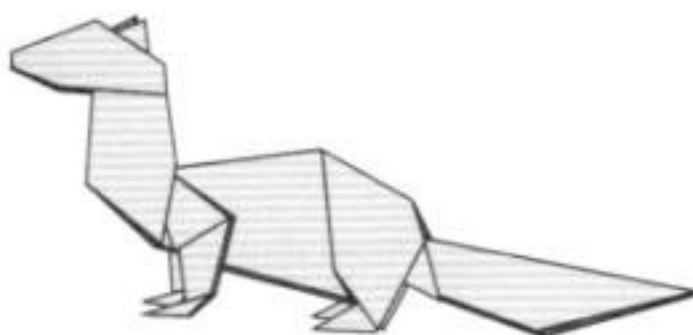

Fold and unfold
along the diagonal.

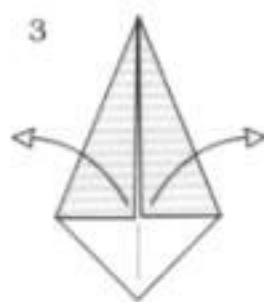
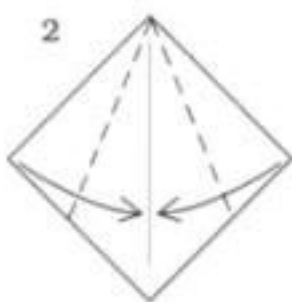

Unfold.

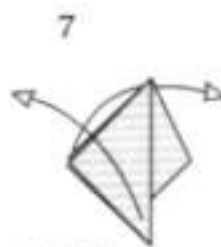
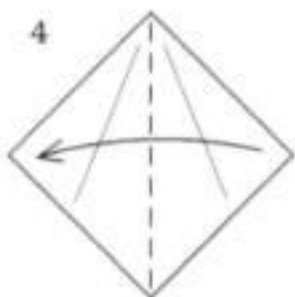

Unfold.

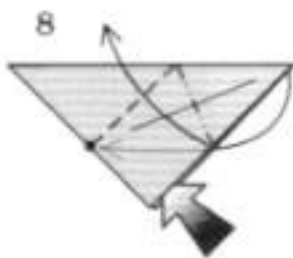

Squash-fold.

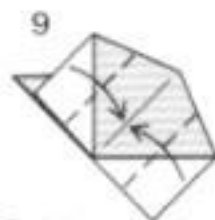

Rotate.



Unfold.

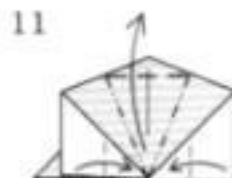

Petal-fold.

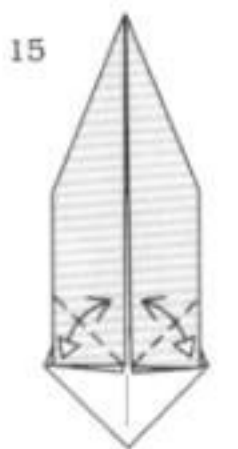
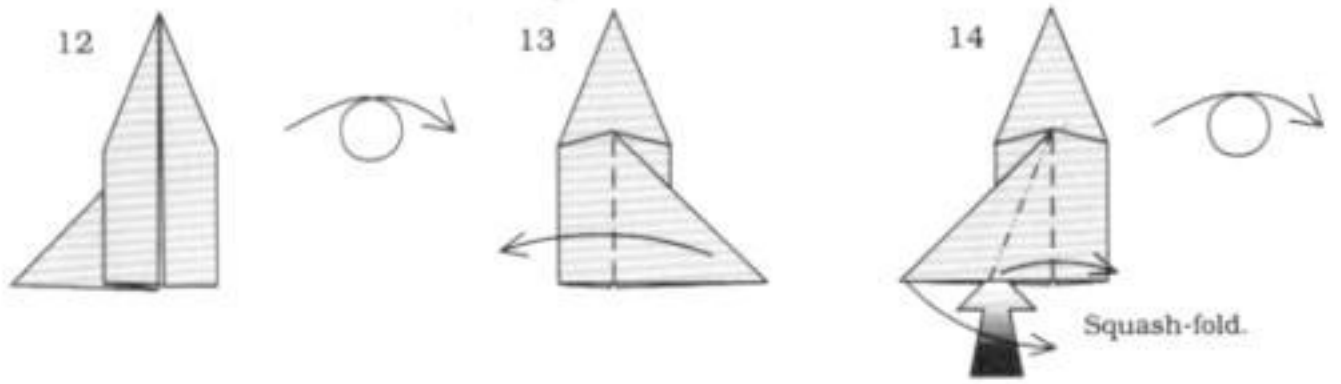

Fold and unfold.



Fold and unfold.

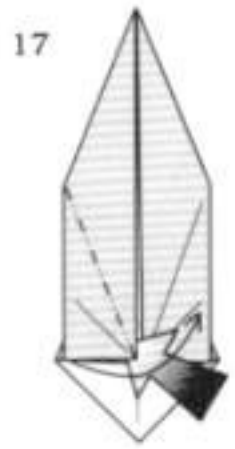

Reverse-fold.

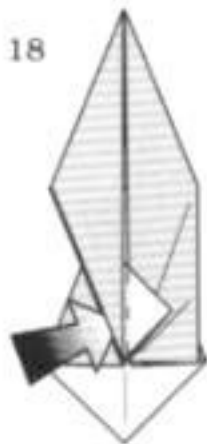

Reverse-fold.

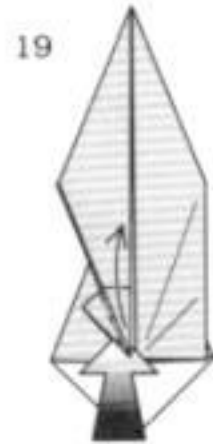

Squash-fold.



Repeat steps 17-19 on the right.

21



22



23



24



Repeat steps 21-23 on the right.

25



Fold and unfold.

26



Reverse folds.

27



28

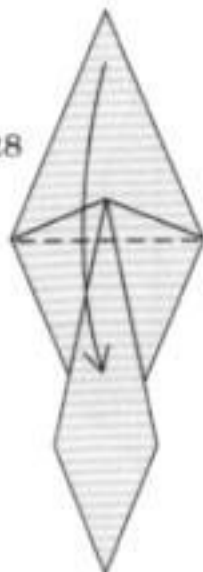

29



30



Squash folds.

31



Fold in half and rotate.

32



Reverse-fold,
repeat behind.

33

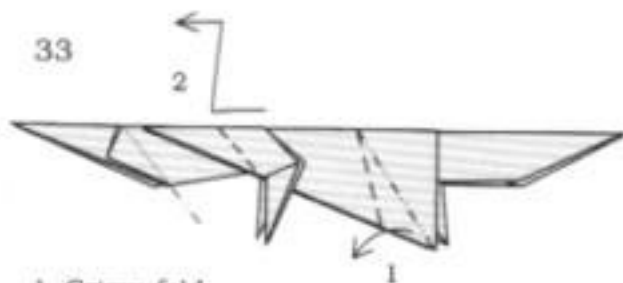

1. Crimp-fold.
2. Outside reverse folds.

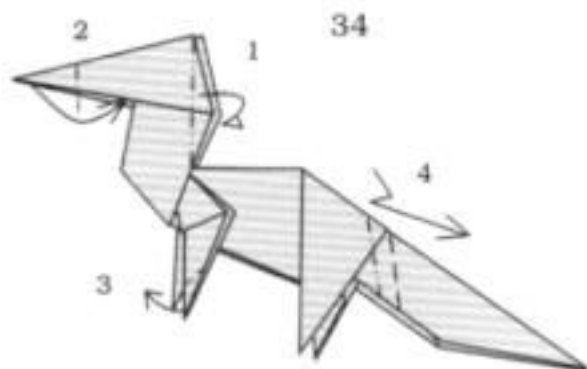

1. Repeat behind.
2. Reverse-fold.
3. Outside-reverse-fold,
repeat behind.
4. Crimp-fold.

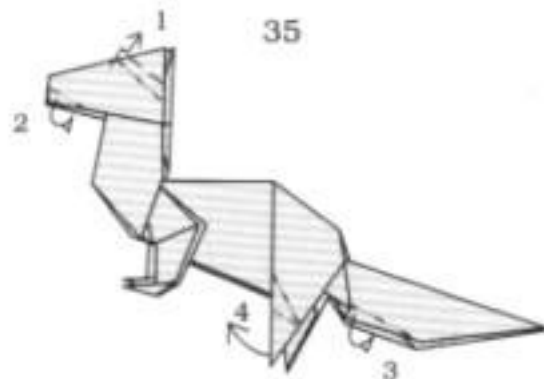

4. Crimp-fold.
Repeat behind.

36

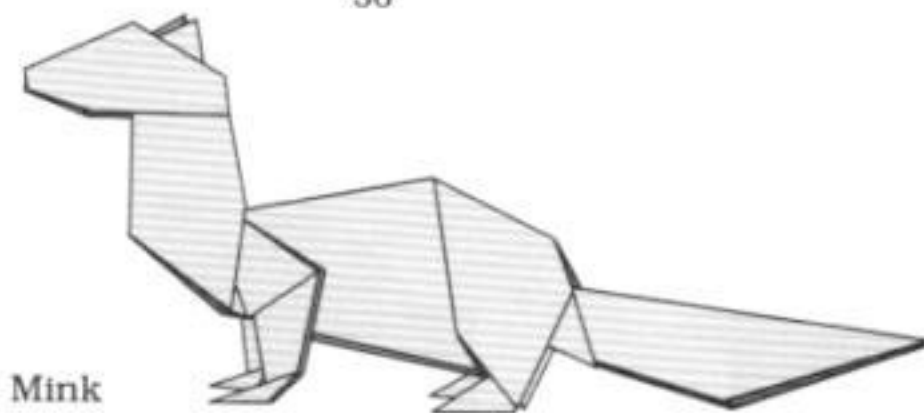

Mink

Pig

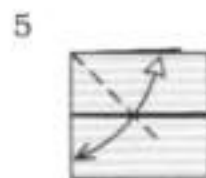
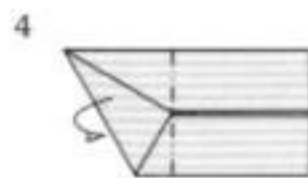
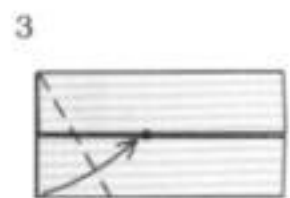
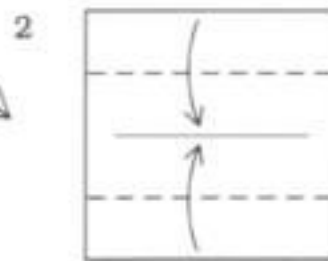
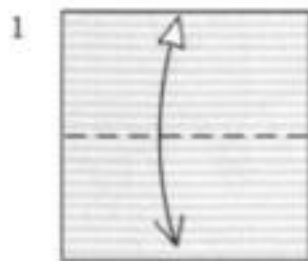
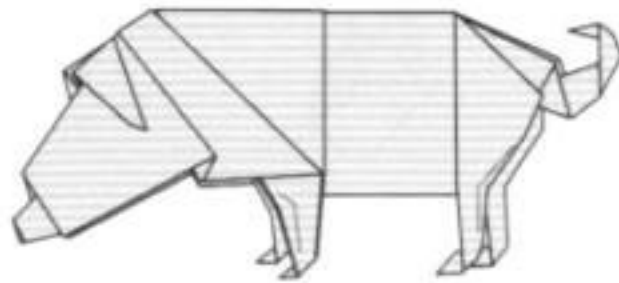

Fold and unfold.

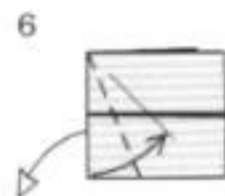

Fold to the crease while unfolding the paper from behind.

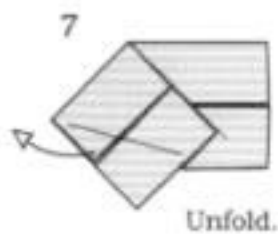

Unfold.



10

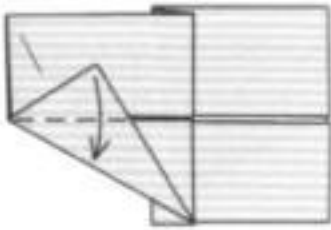

11

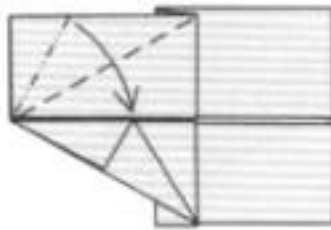

12

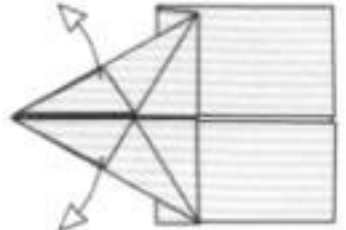

Unfold.

13

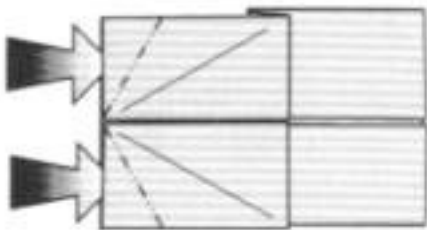

Reverse folds.

14

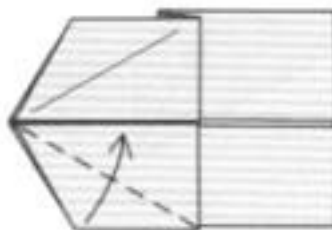

15

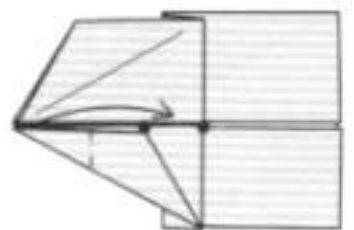

Reverse-fold so the tip will be halfway between the dots.

16

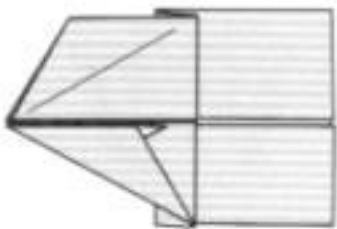

Repeat steps 14-15 above.

17

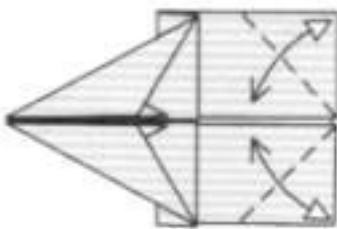

Fold and unfold.

18

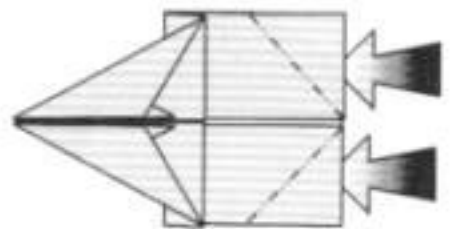

Reverse folds.

19

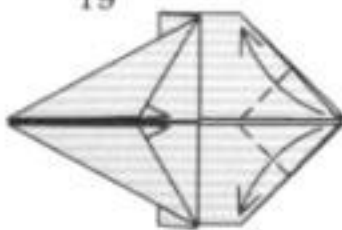

20

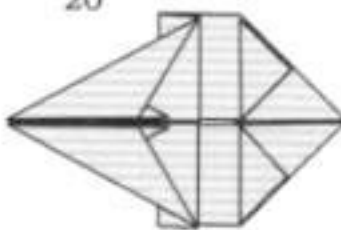

21

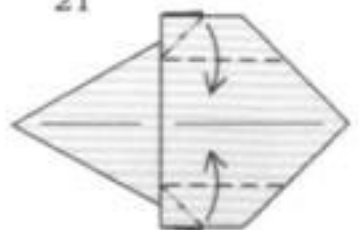

Squash folds.

22

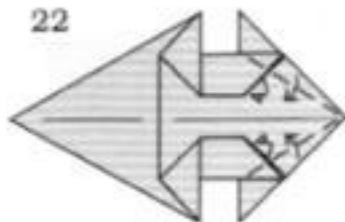

23

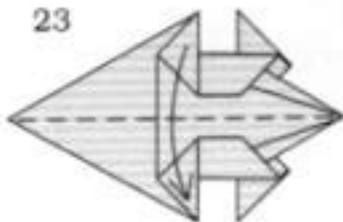

24



Double-rabbit-ear.

25

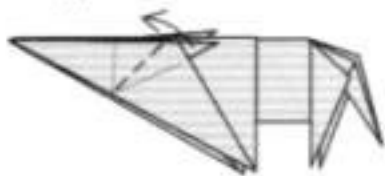

Repeat behind.

26



Crimp-fold.

27

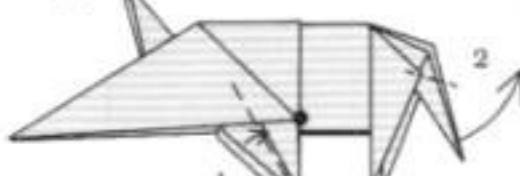

1. Tuck inside, repeat behind.
2. Reverse-fold.

28

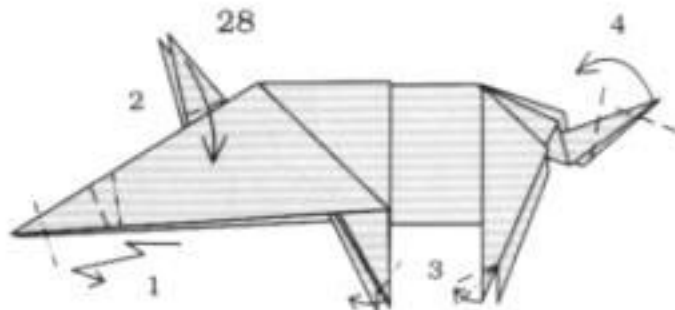

Repeat behind.

29

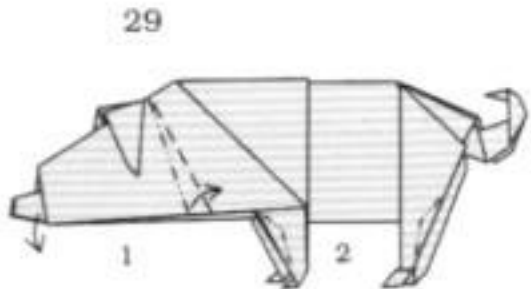

1. Crimp-fold.
2. Shape the legs, repeat behind.

30

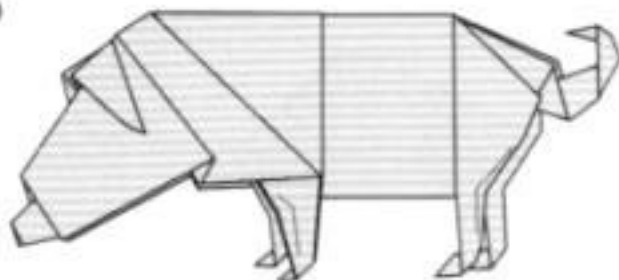

Pig

Llama

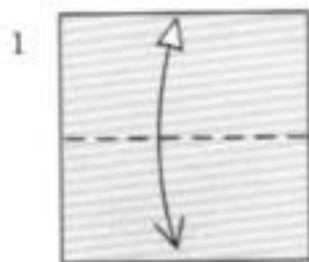
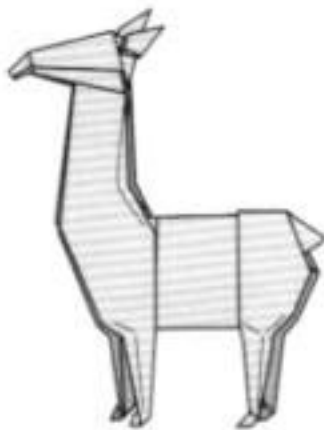

Fold and unfold.

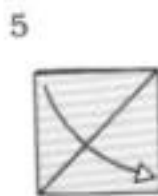
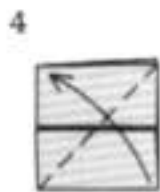
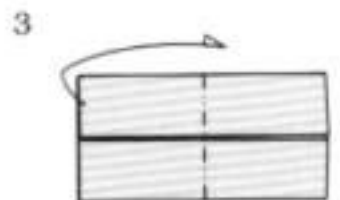
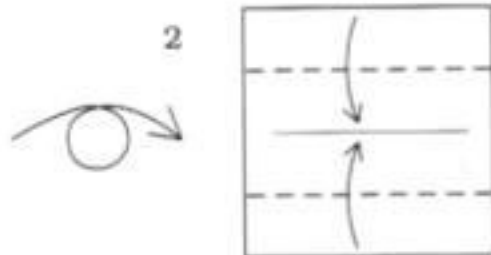

Unfold.

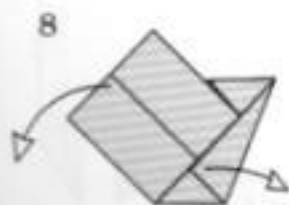
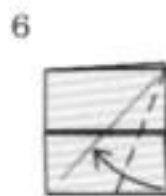

Unfold.

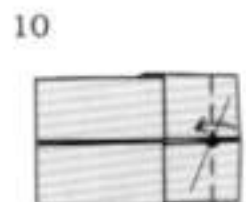

11

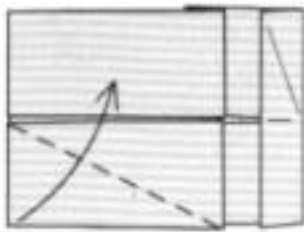

12

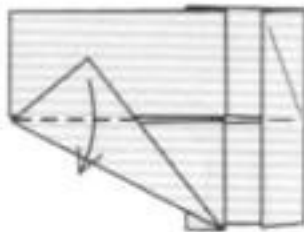

13

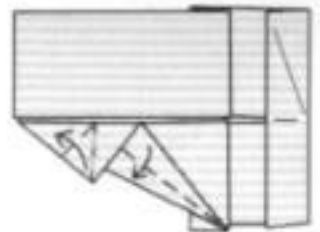

Squash-fold.

14

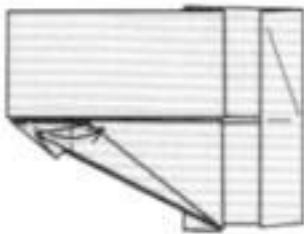

15

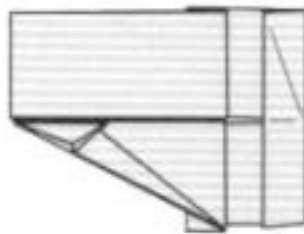

16

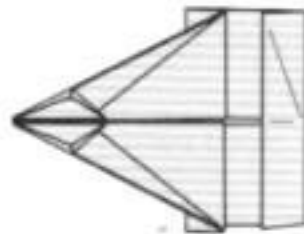

Repeat steps 11-14 above.

17

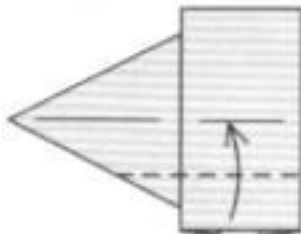

18

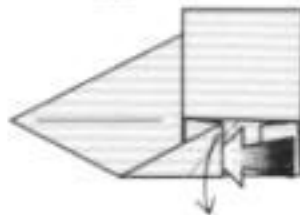

Squash-fold.

19

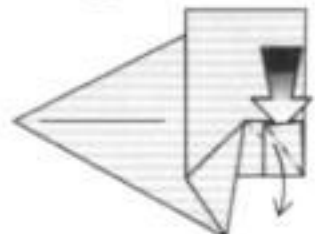

Squash-fold.

20

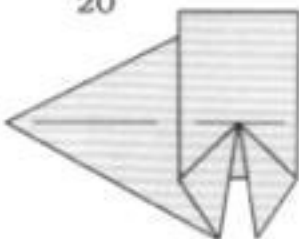

21

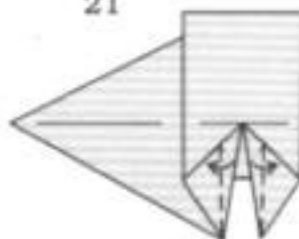

22

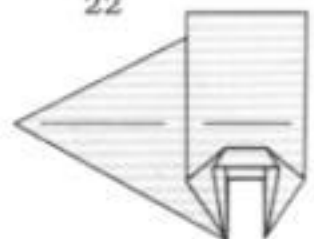

Repeat steps 17-21 above.

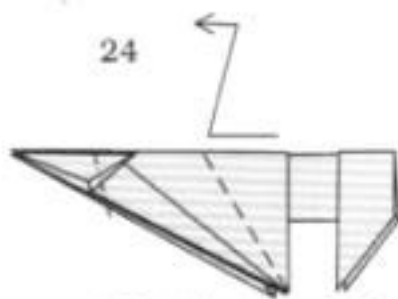
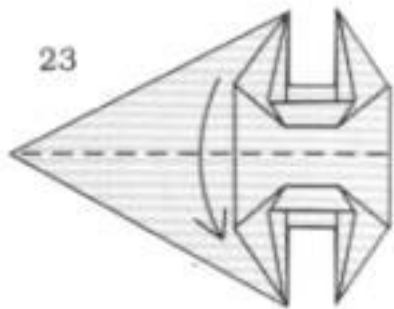

Outside-reverse folds.

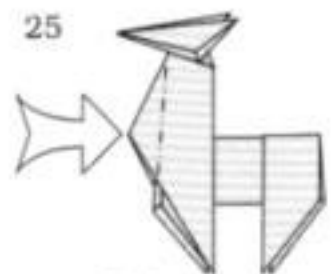

Sink.

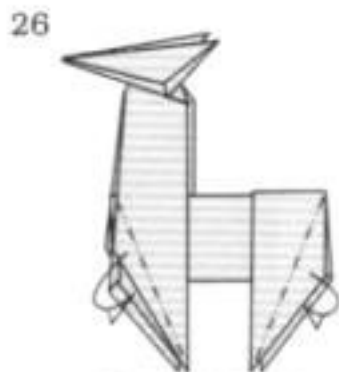

Repeat behind.

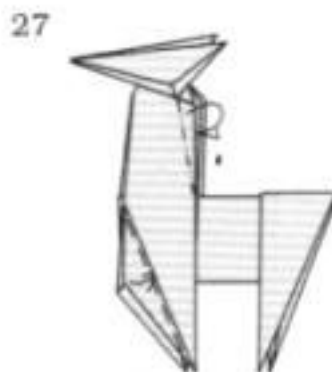

Tuck inside,
repeat behind.



Repeat behind.

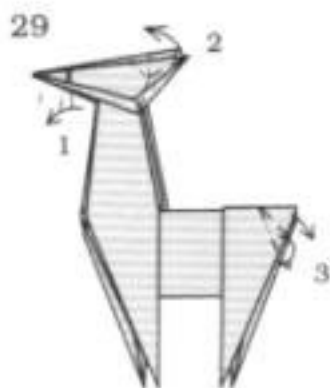

1. Crimp-fold.
2. Rabbit-ear, repeat behind.
3. Crimp-fold.



1. Squash-fold.
2. Make little hooves.
Repeat behind.

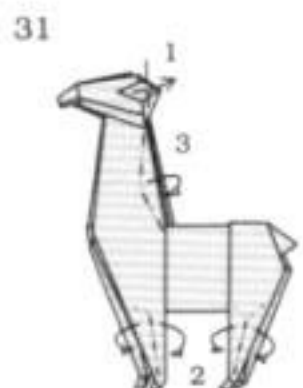

Repeat behind.

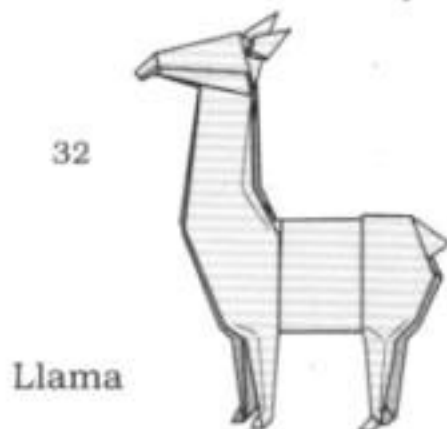

Deer

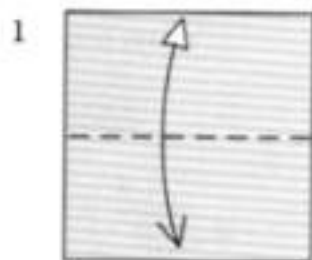

Fold and unfold.

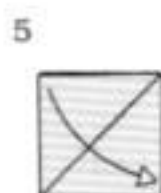
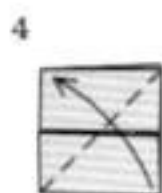
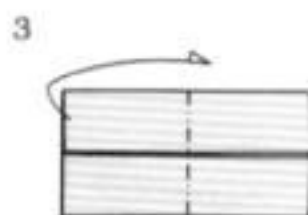
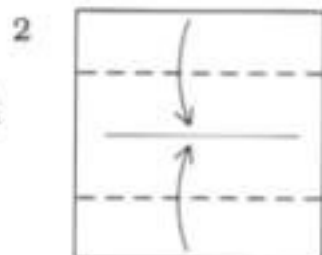

Unfold.

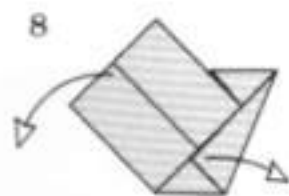
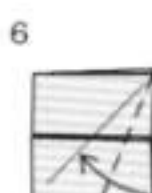

Unfold.



11

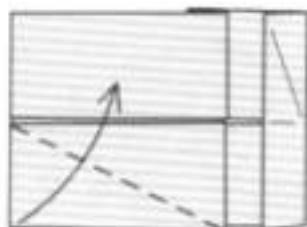

12

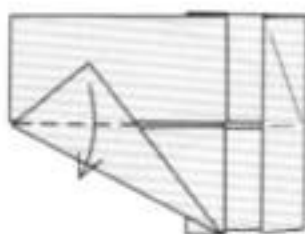

13



14

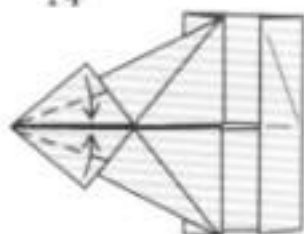

15

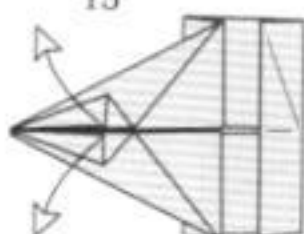

Unfold.

16



Reverse-fold.

17

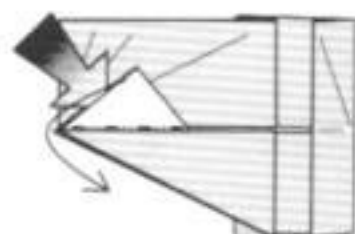

Reverse-fold.

18

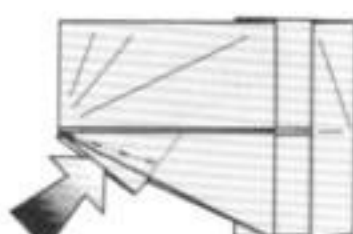

Reverse-fold.

19

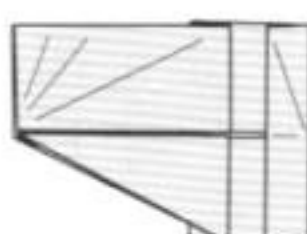

Repeat steps 16-18 above.

20

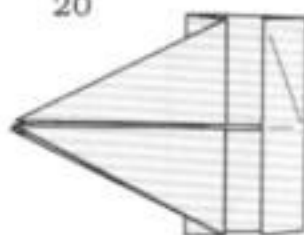

21

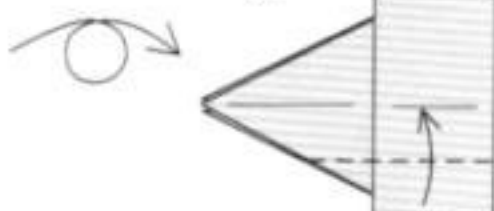

22

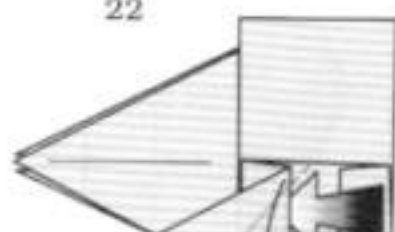

Squash-fold.

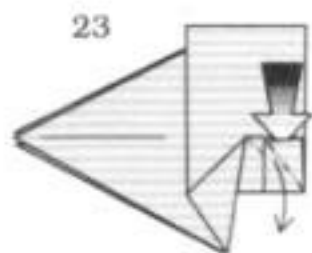

Squash-fold.

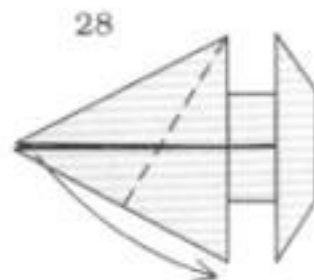
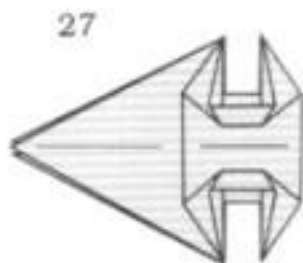
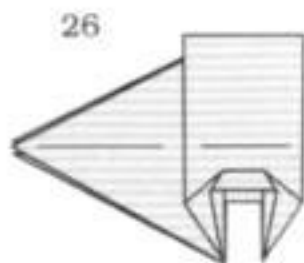
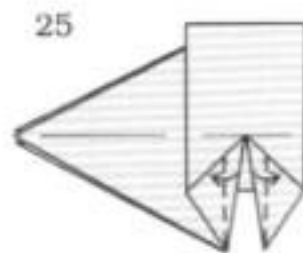
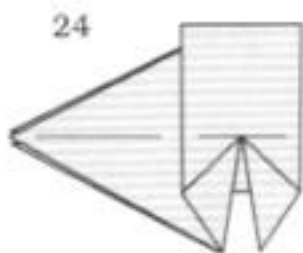

Repeat steps 21-25 above.

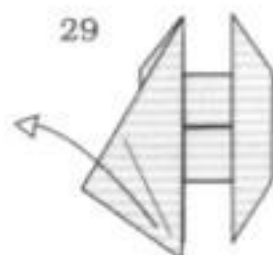

Unfold.

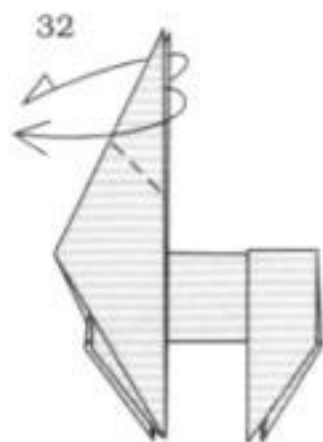
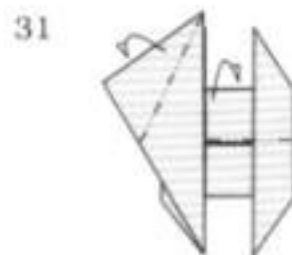
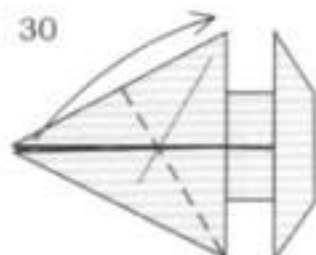

Outside-reverse-fold.

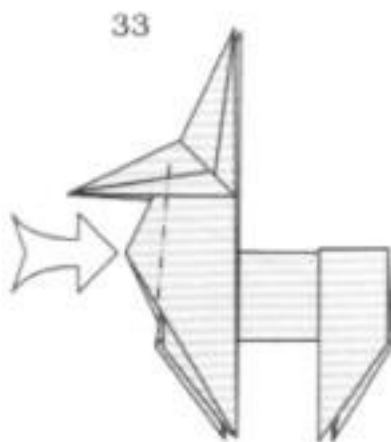

Sink.

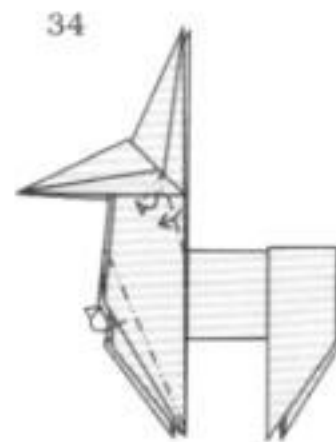

Repeat behind.

35

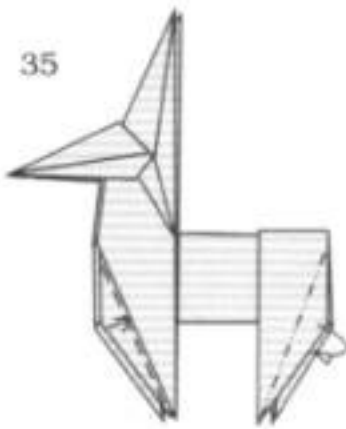

Repeat behind.

36

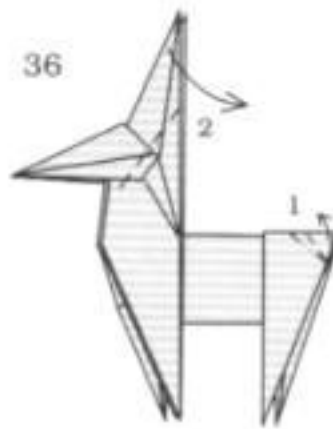

1. Crimp-fold.
2. Repeat behind.

37

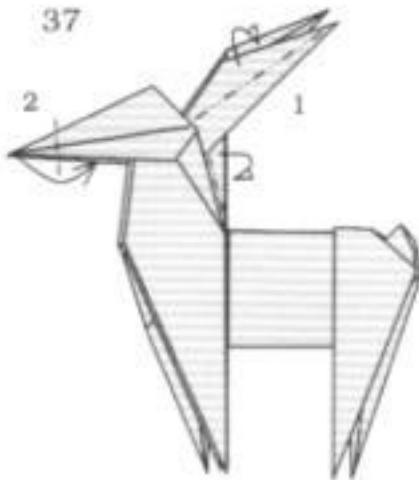

1. Repeat behind.
2. Reverse-fold.

38

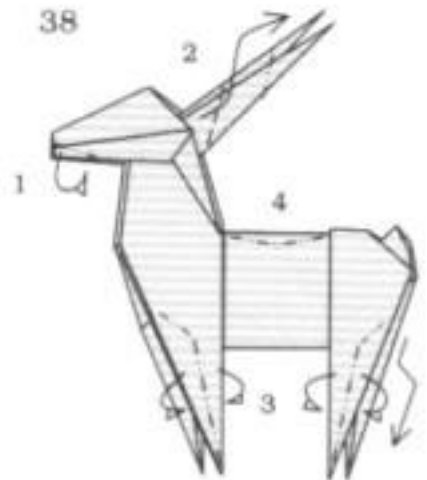

Repeat behind.

39

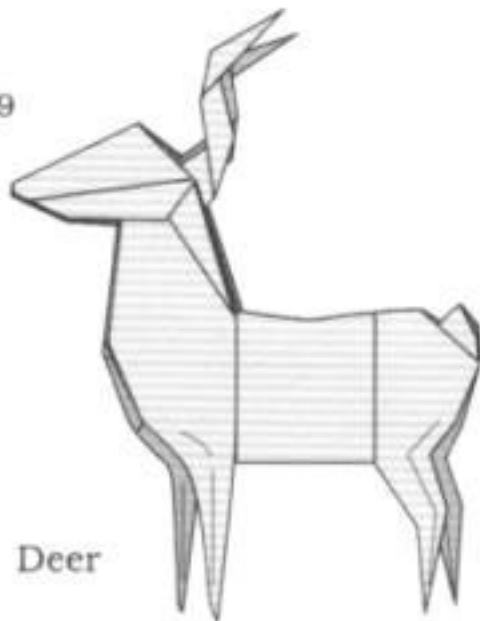

Deer

Fox

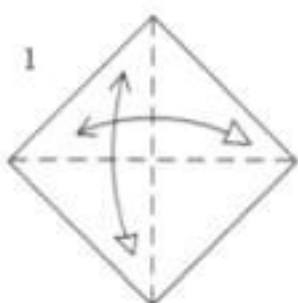
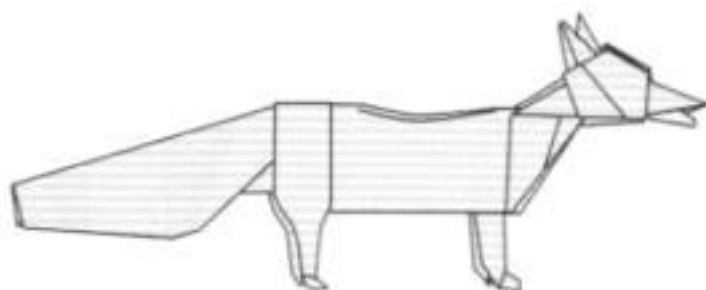

Fold and unfold
along the diagonals.

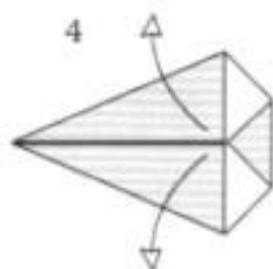
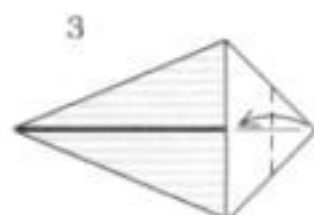
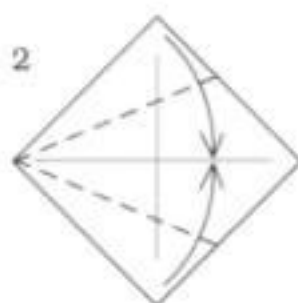

Unfold.

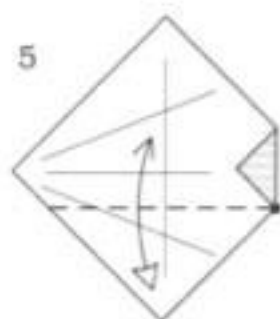

Fold up and unfold.

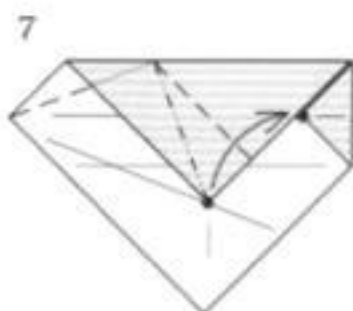
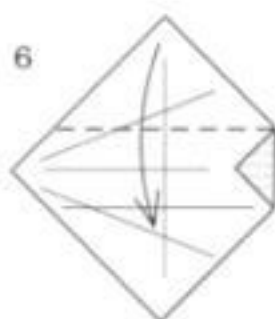

Squash-fold.

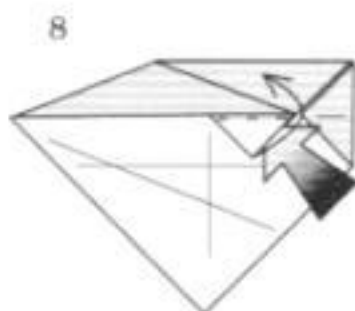

Reverse-fold.

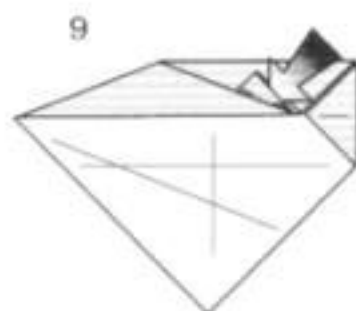

Reverse-fold.

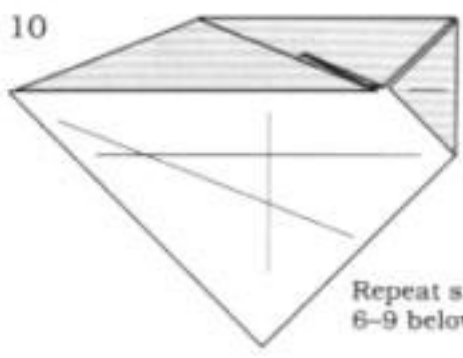

Repeat steps 6-9 below.

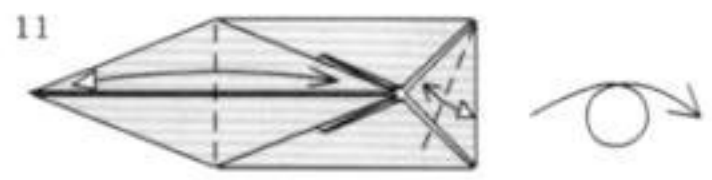

Fold and unfold.

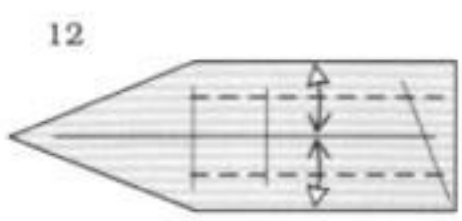

Fold and unfold.

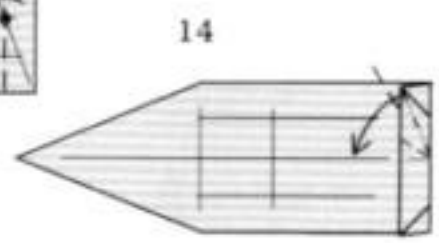
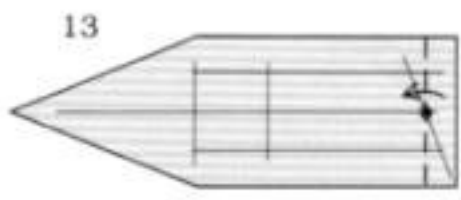

Squash-fold.

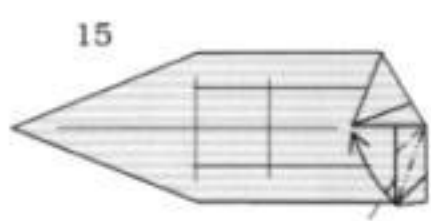

Squash-fold.

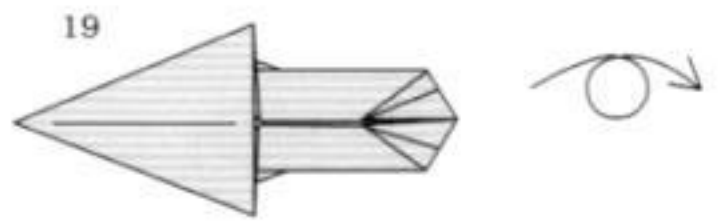
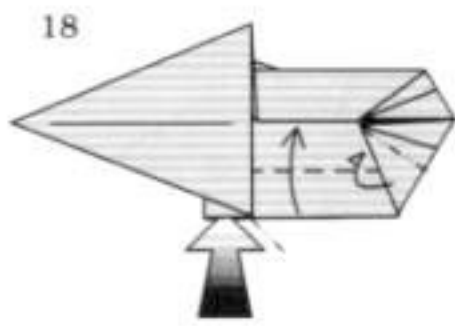
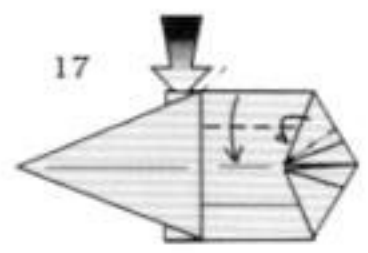
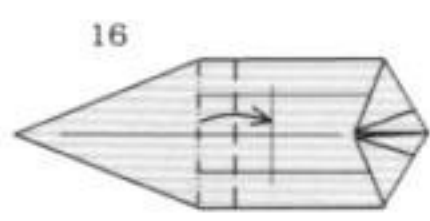

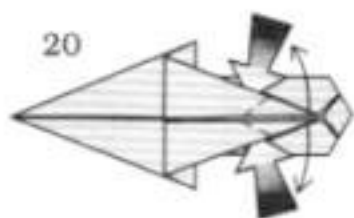

Reverse folds.

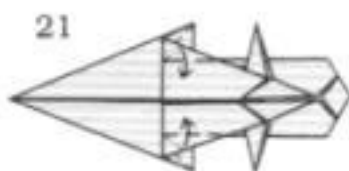

Squash folds.

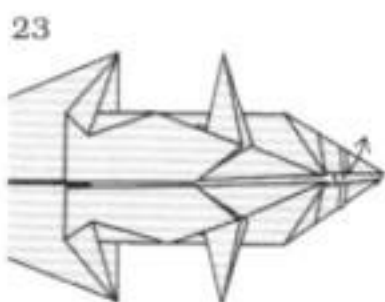
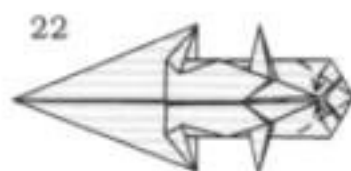

Pull out the corner.

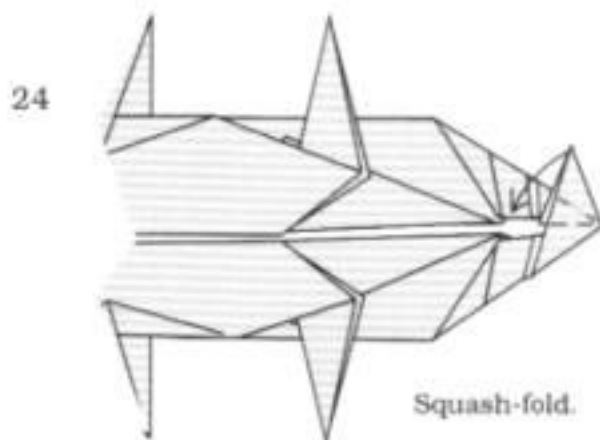

Squash-fold.

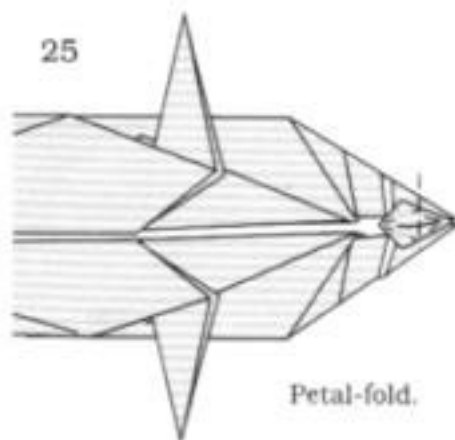

Petal-fold.

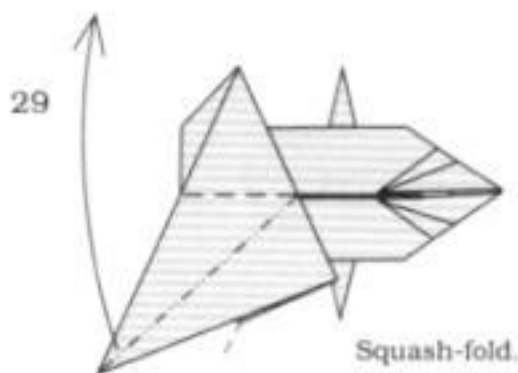
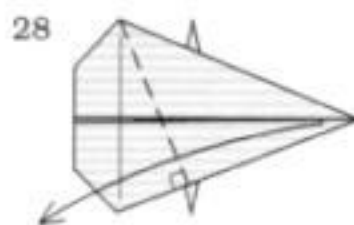
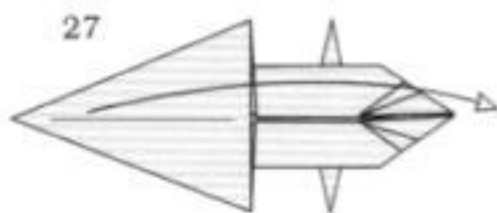
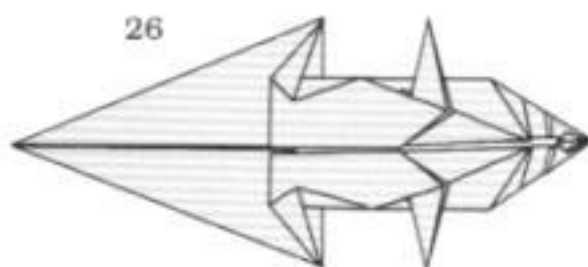

Squash-fold.

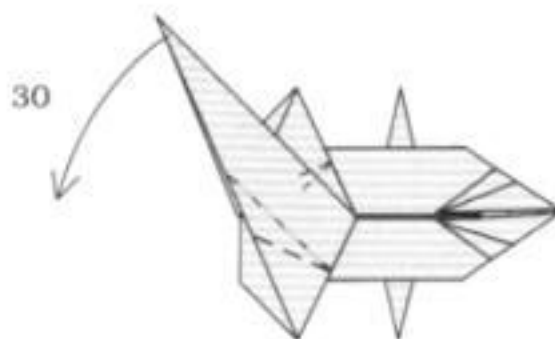

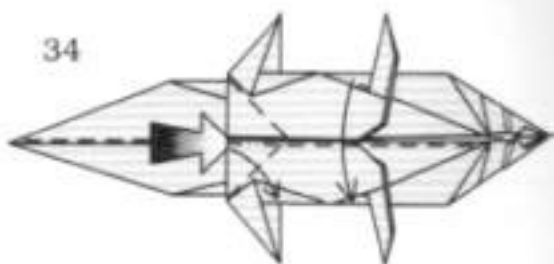
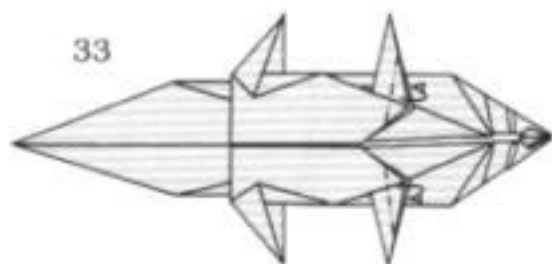
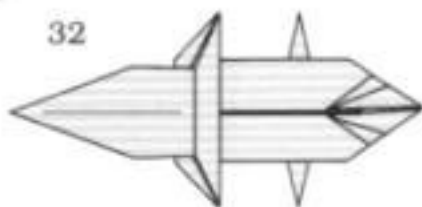
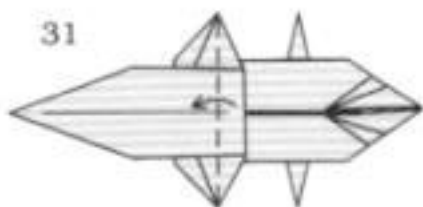

Repeat behind.

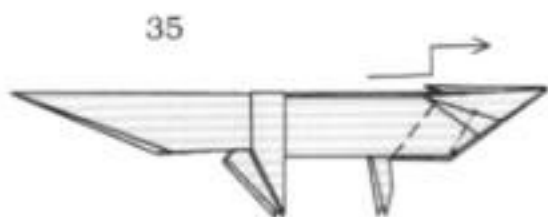

Outside reverse folds.

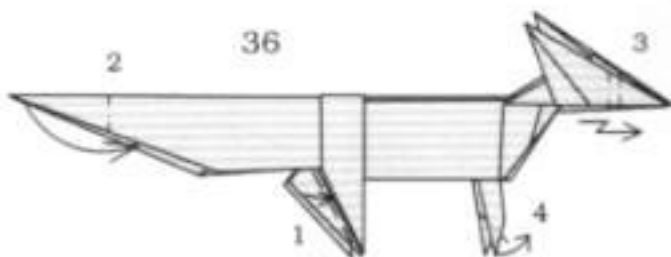

1. Tuck inside.
2. Reverse-fold.
3. Crimp-fold.
4. Reverse-fold.
Repeat behind.

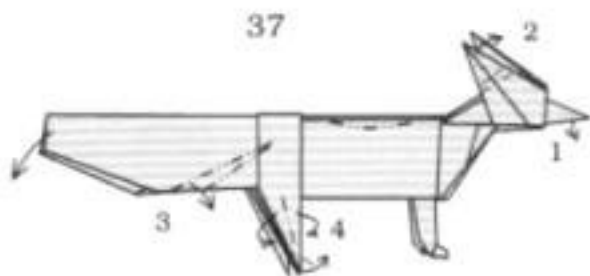

Repeat behind.

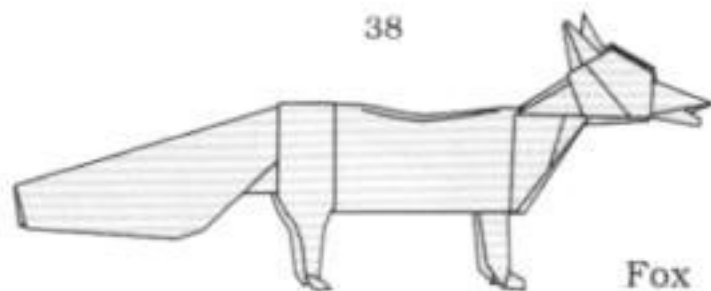

Fox

Bull

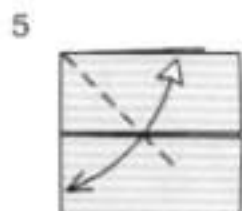
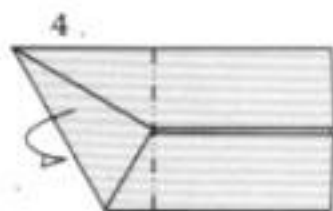
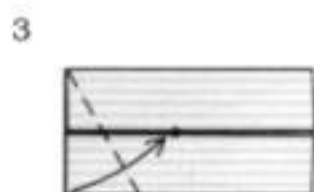
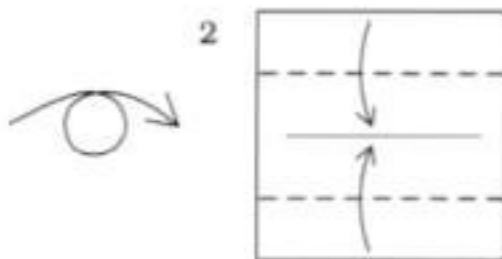
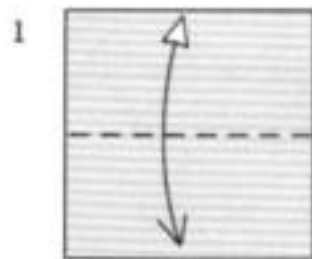
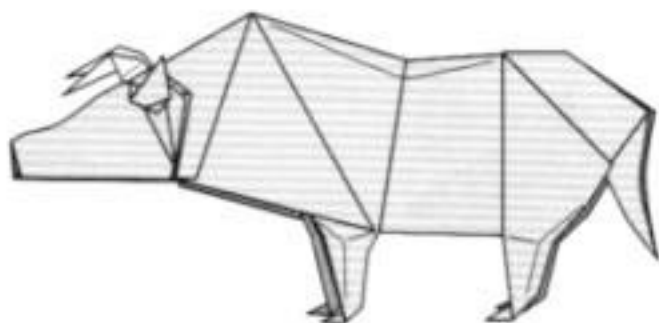

Fold and unfold.

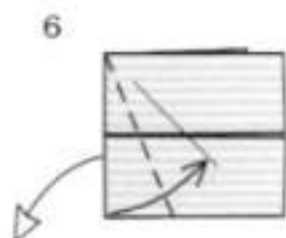

Fold to the crease while unfolding the paper from behind.

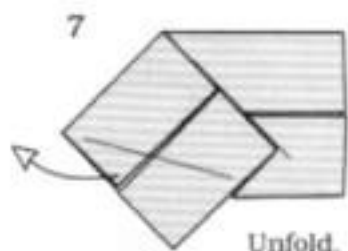

Fold and unfold.

10



11

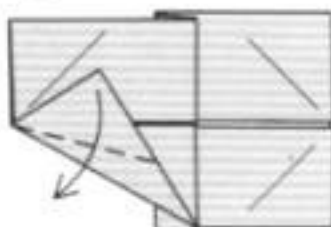

Fold on the crease.

12

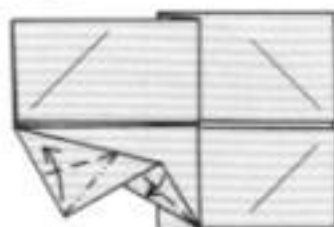

Squash-fold.

13

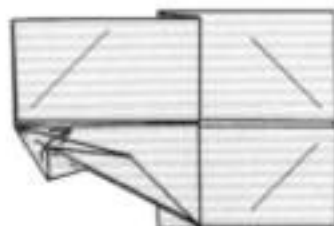

Reverse-fold.

14



Repeat steps 10-13 above.

15

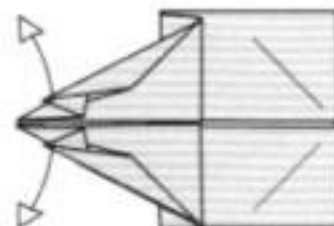

Unfold.

16

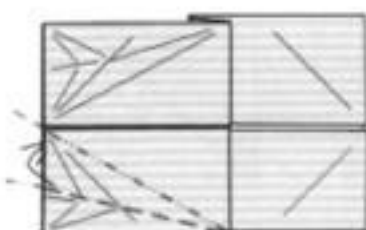

Crimp-fold.

17



Reverse-fold, repeat behind.

18

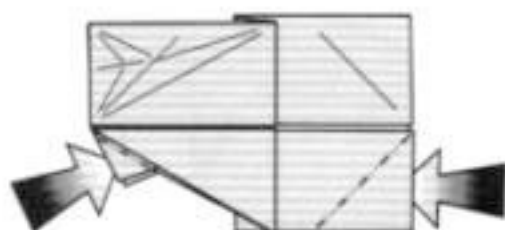

Reverse folds, repeat behind.

19

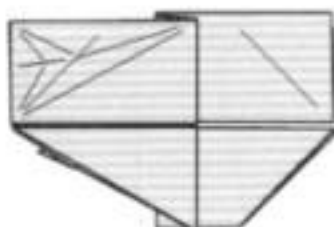

Repeat steps 16-18 above.

20

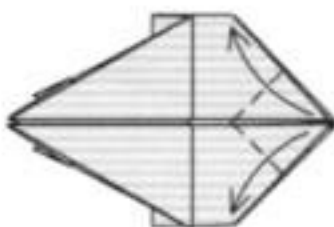

21

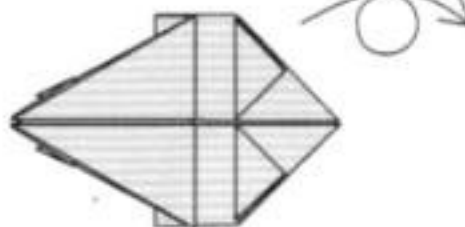

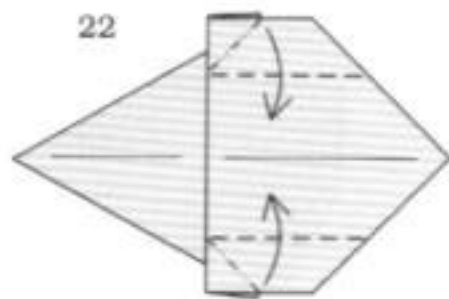

Squash folds.

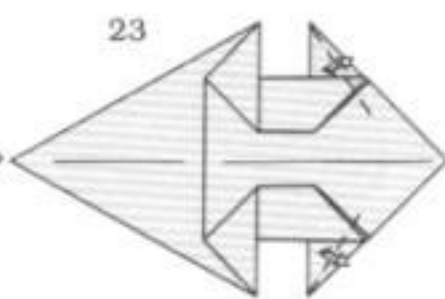

Fold at an angle of one-third, unfold.

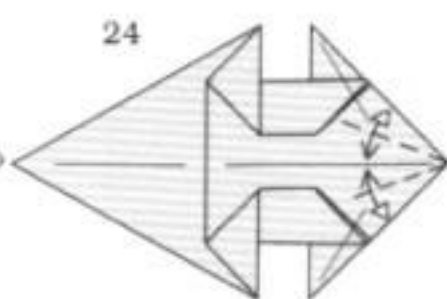

Fold and unfold.

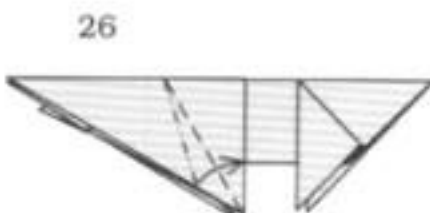
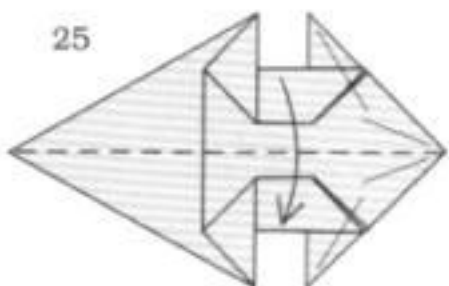

Crimp-fold.

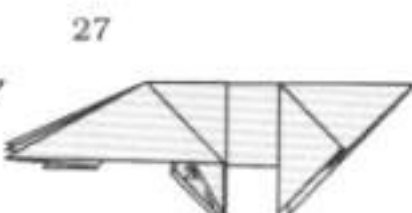

Tuck inside, repeat behind.

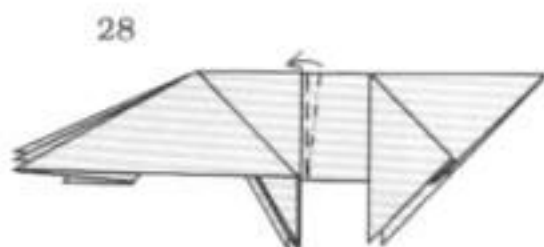

Open the model for this crimp fold. Crimp so that the front legs will be balanced.

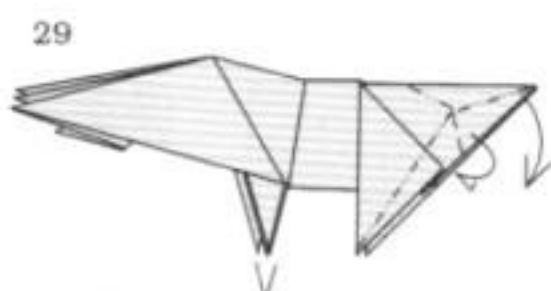

Note how the front legs are centered. Double-rabbit-ear the tail along the creases.

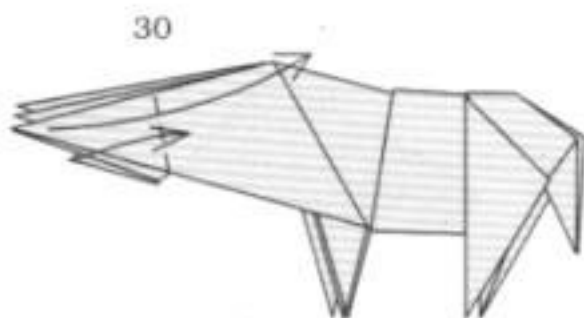

Repeat behind.

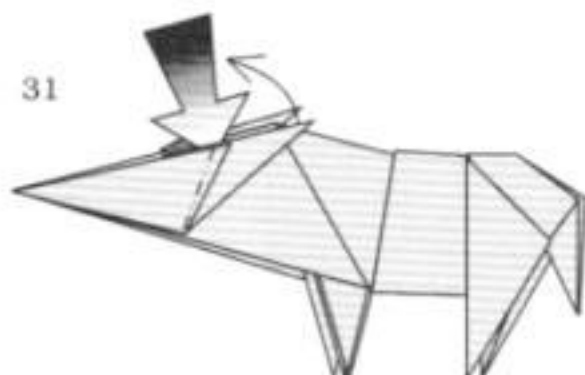

Reverse-fold, repeat behind.

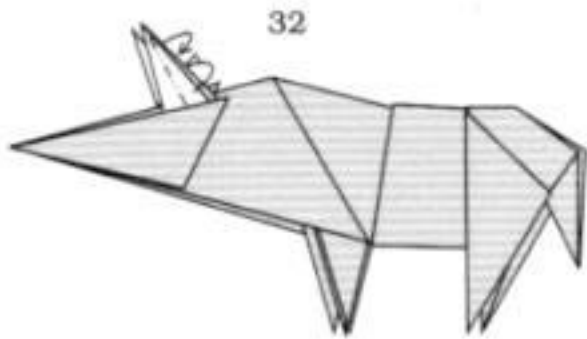

Repeat behind.

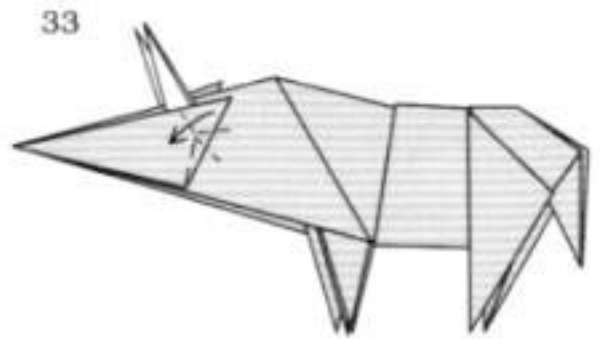

Repeat behind.

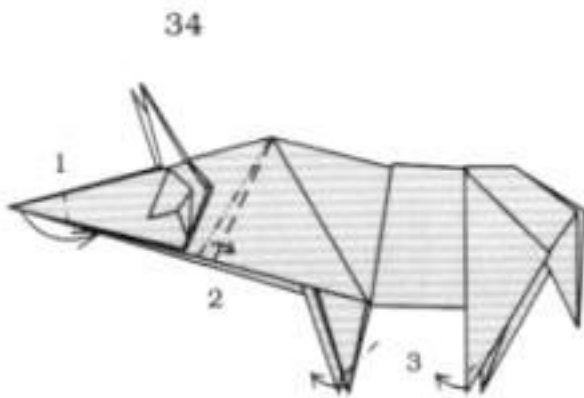

1. Reverse-fold.
2. Crimp-fold.
3. Reverse-fold, repeat behind.

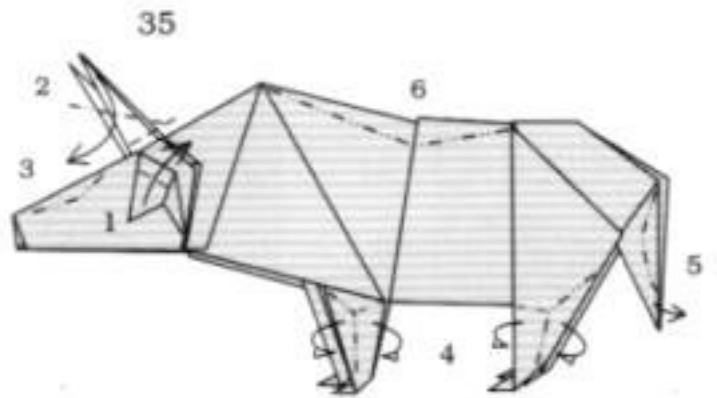

Repeat behind.

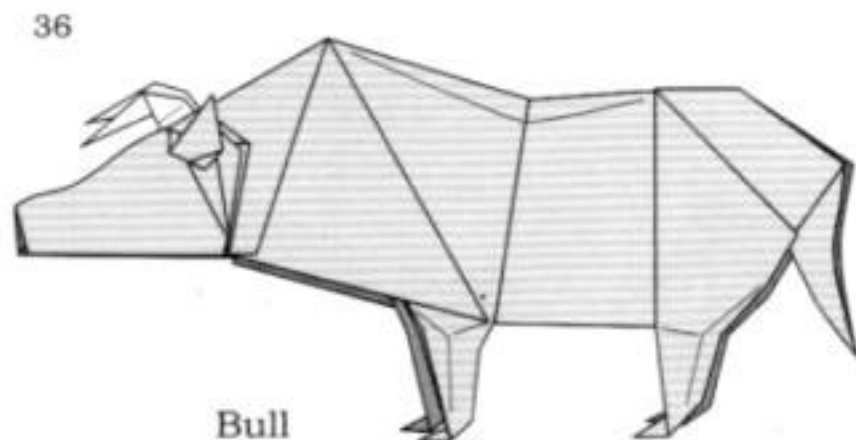

Lion

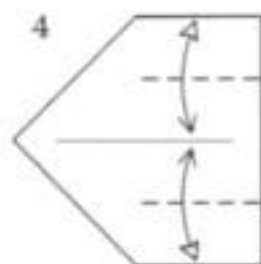
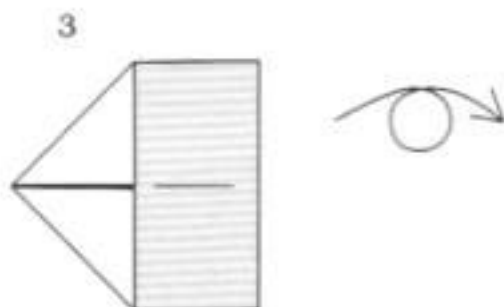
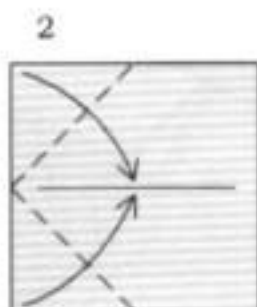
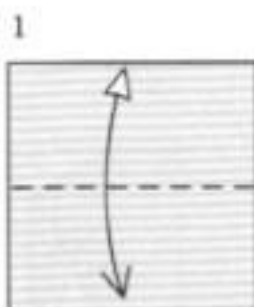
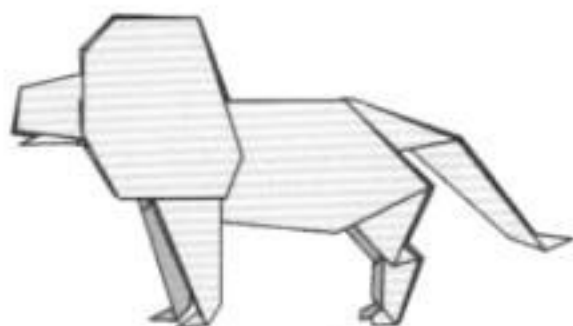

Fold and unfold.

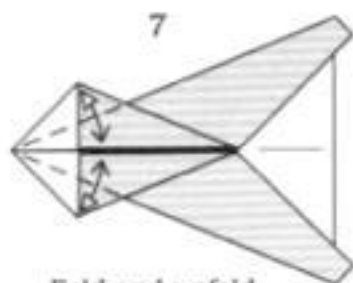
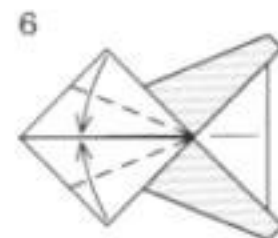
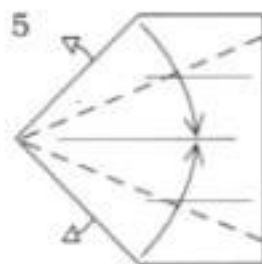

Fold and unfold.

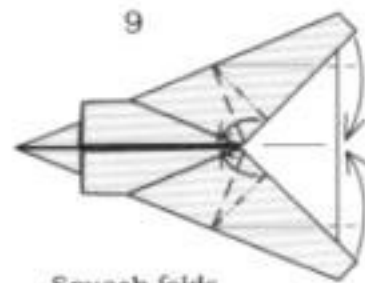
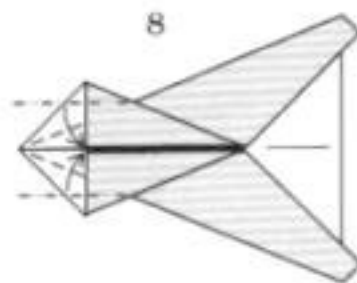

Squash folds.

10

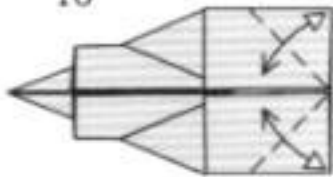

Fold and unfold.

11

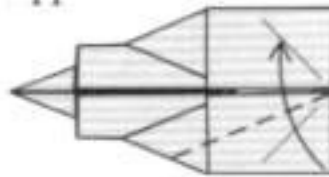

12

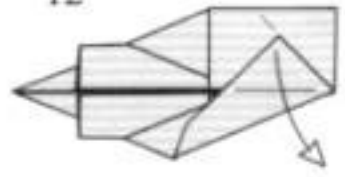

Unfold.

13

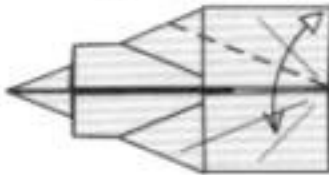

Unfold.

14

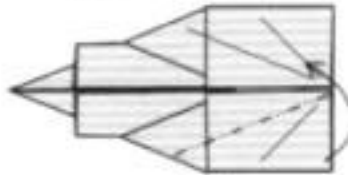

Reverse-fold.

15

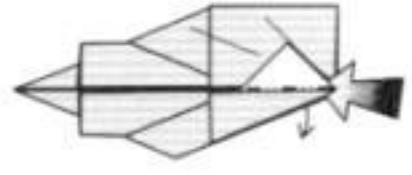

Reverse-fold.

16

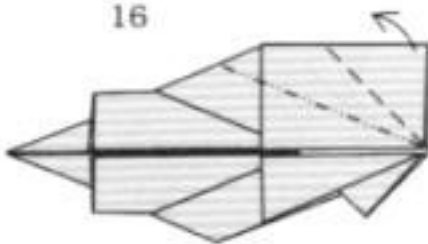

Reverse folds.

17

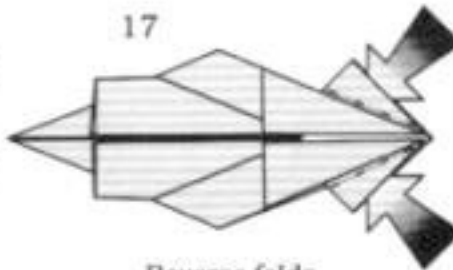

Reverse folds.

18

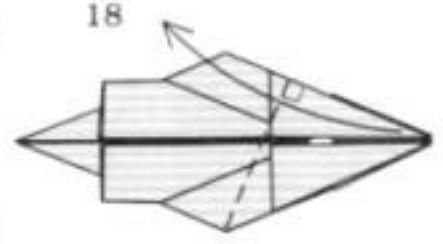

19

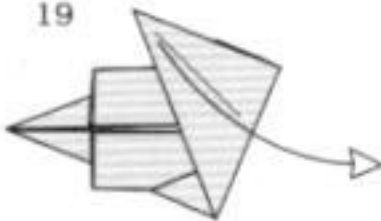

Unfold.

20

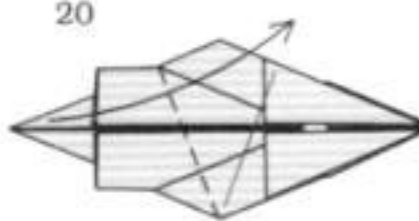

21

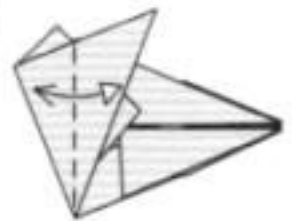

Fold and unfold.

22

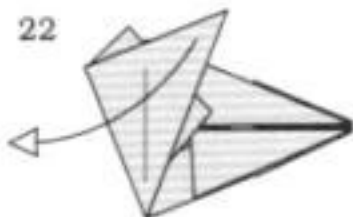

Unfold.

23

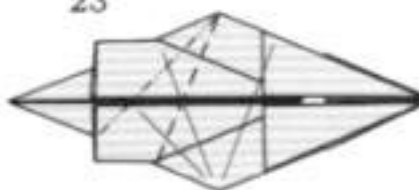

Repeat steps 20-22.

24

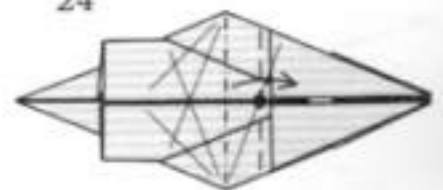

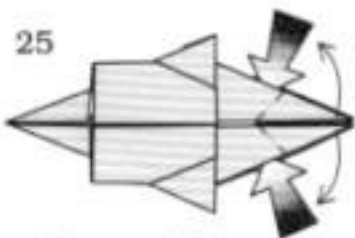

Reverse folds.

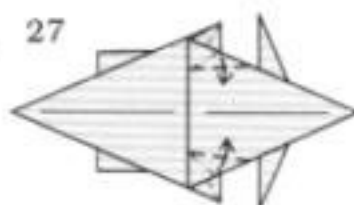
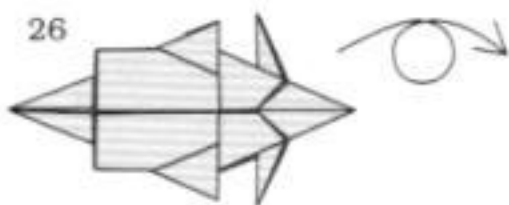

Squash folds.

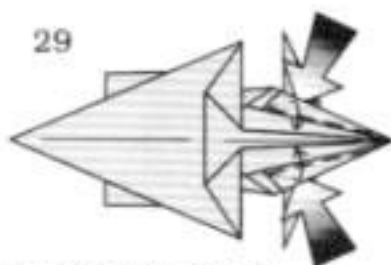
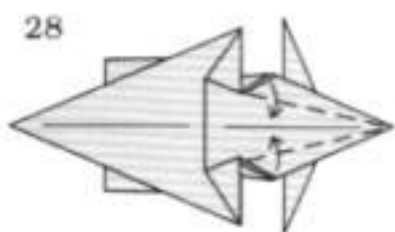

Spread squash folds.

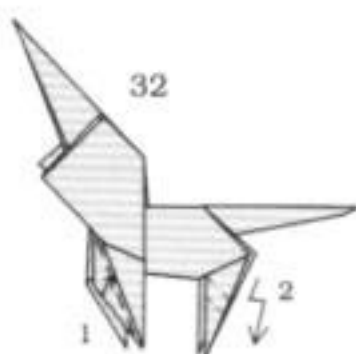
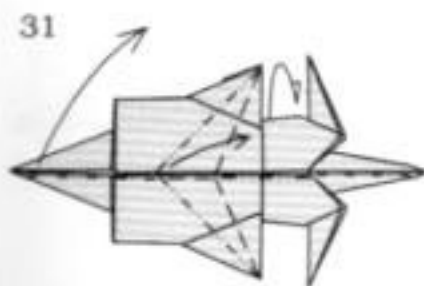
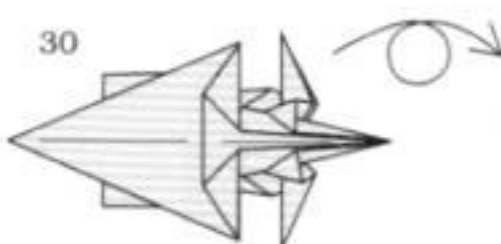

1. Tuck inside.
2. Reverse folds.
Repeat behind.

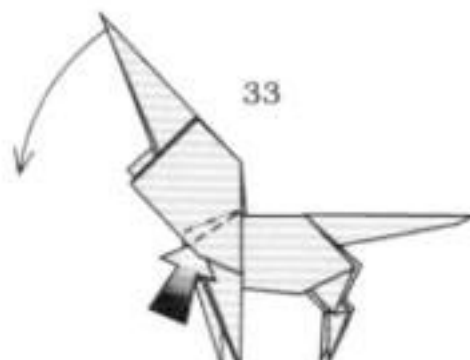

Crimp-fold.

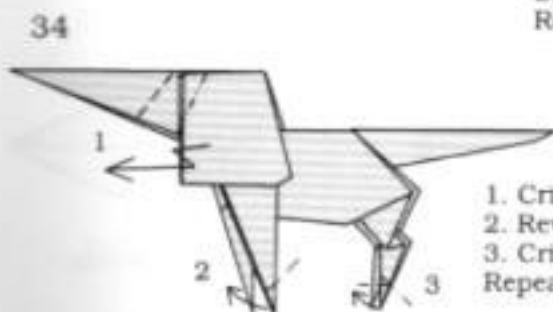

1. Crimp-fold.
2. Reverse-fold.
3. Crimp-fold.
Repeat behind.

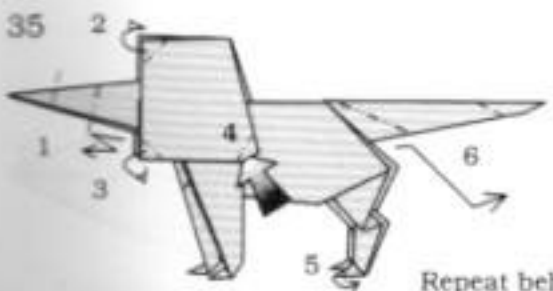

Repeat behind.

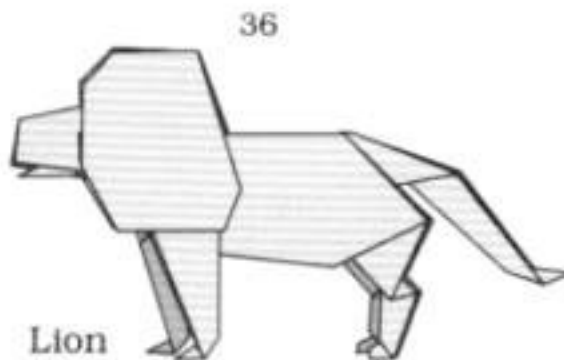

Lion

Elephant

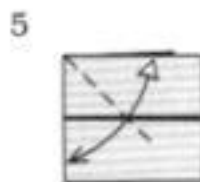
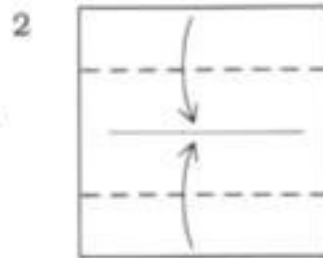
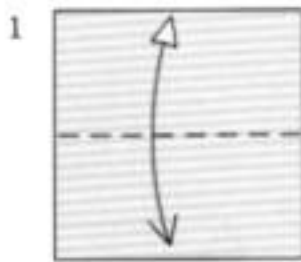
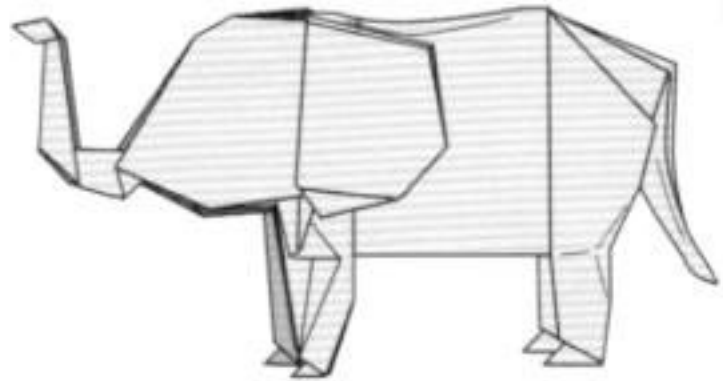

Fold and unfold.

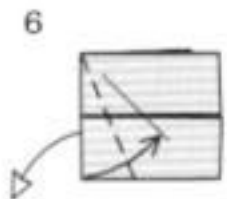

Fold to the crease while unfolding the paper from behind.

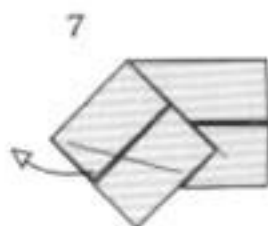

Unfold.

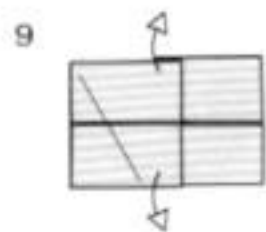

Unfold everything.

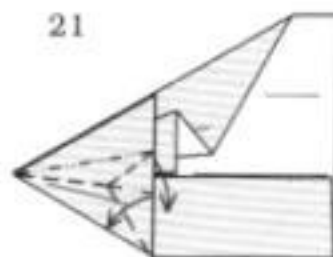
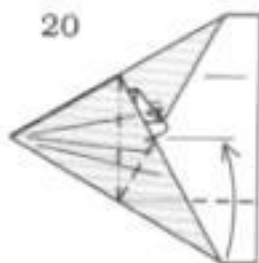
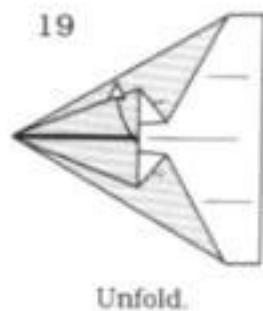
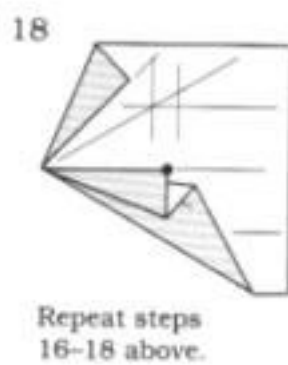
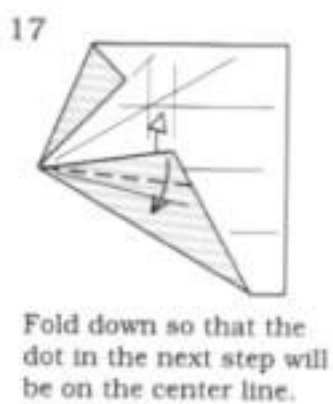
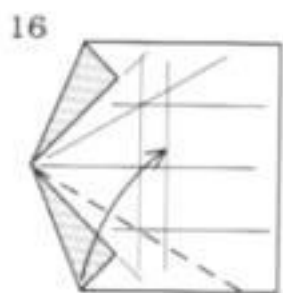
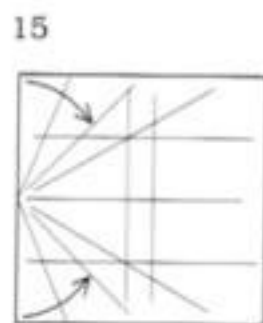
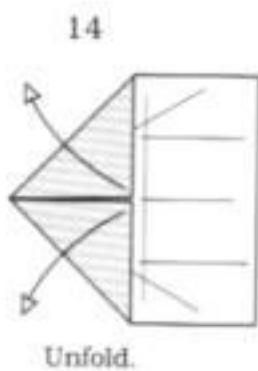
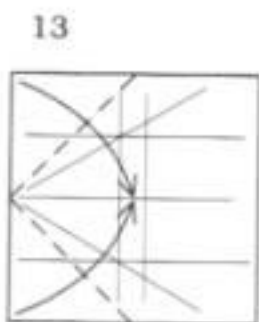
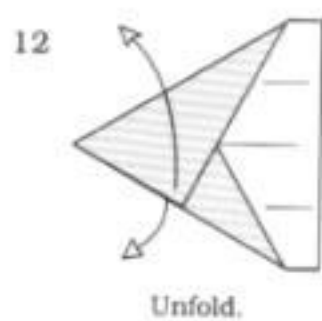
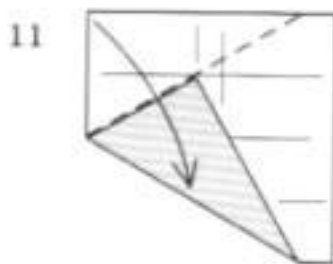
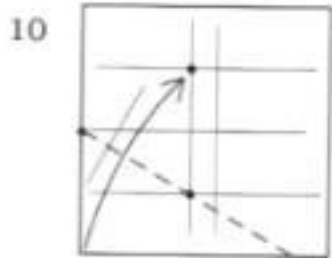

22

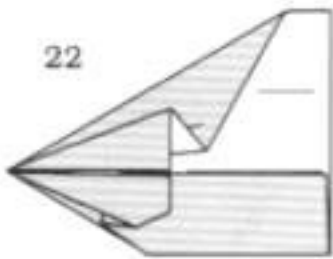

Repeat steps 19-21 above.

23

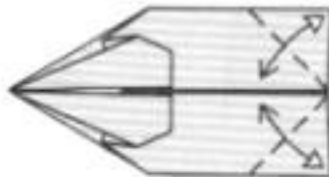

Fold and unfold.

24

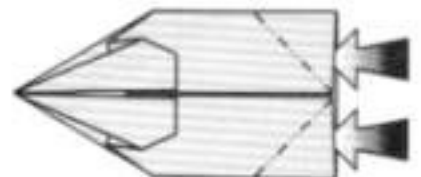

Reverse folds.

25

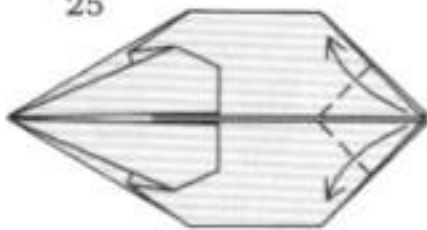

26

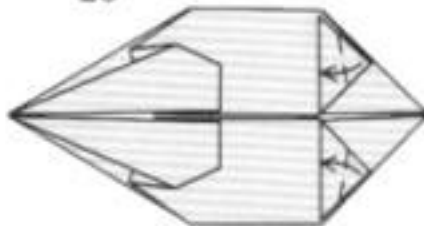

Fold to the line.

27

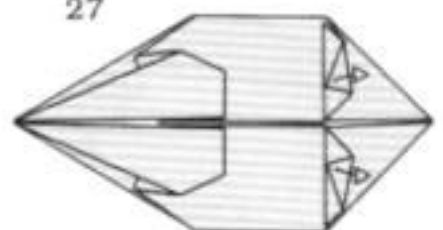

Unfold.

28

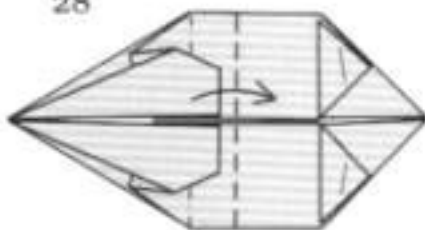

Fold on the creases.

29

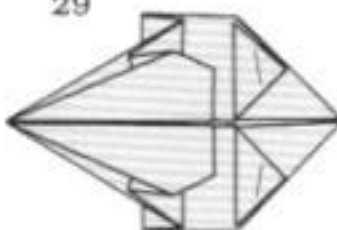

30

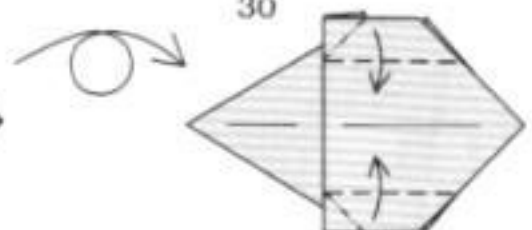

Squash folds.

31

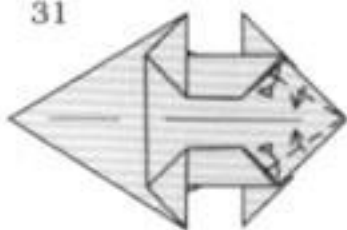

32

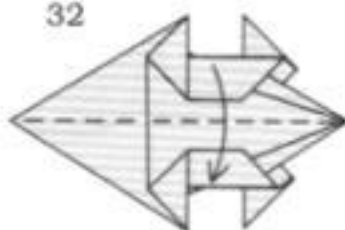

33

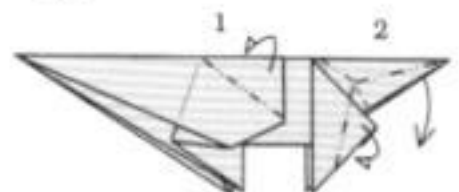

1. Tuck inside, repeat behind.
2. Double-rabbit-ear.

34

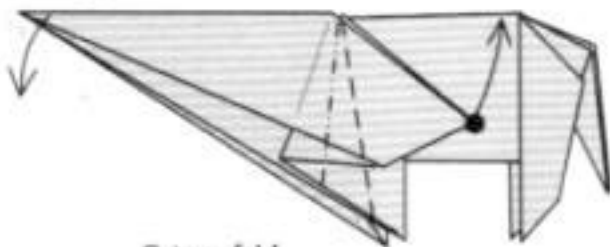

Crimp-fold.

35

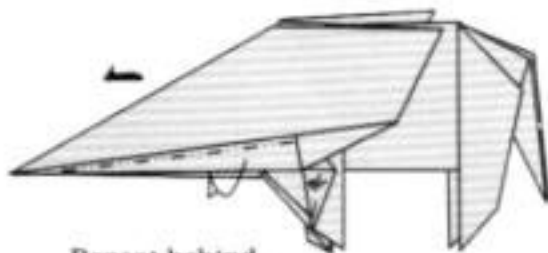

Repeat behind.

36

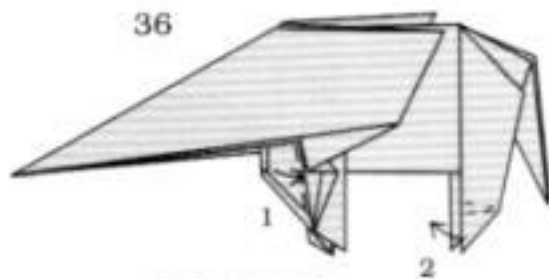

1. Tuck inside.
2. Crimp-fold.
Repeat behind.

37

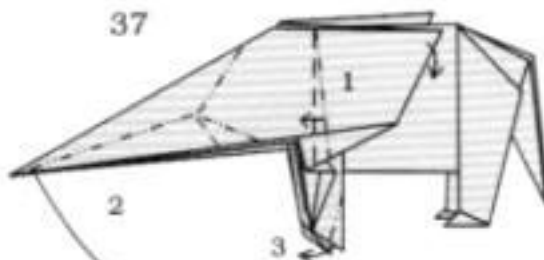

1. Pleat-fold the ear.
2. Double-rabbit-ear.
3. Reverse-fold.
Repeat behind.

38

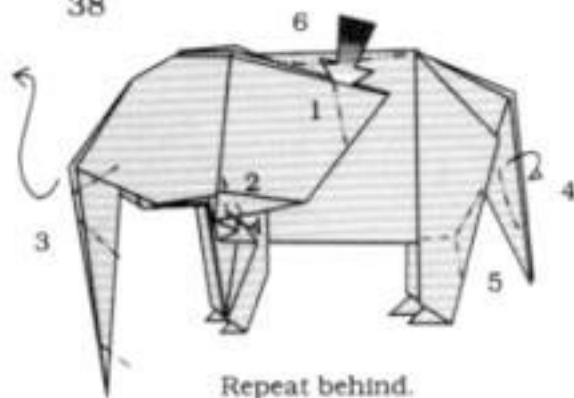

Repeat behind.

39

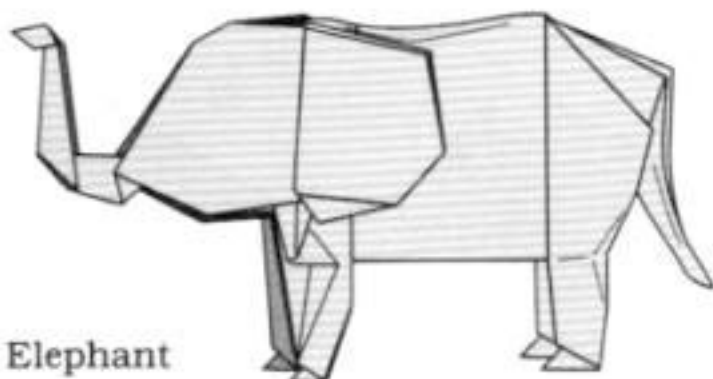

Elephant

FAVORITE ANIMALS IN ORIGAMI

John Montroll

Lovers of the ancient Japanese art of paperfolding will welcome this delightful collection of animal origami projects. Noted origami expert John Montroll provides over 300 black-and-white diagrams and step-by-step instructions for creating 12 familiar animals.

Graded according to difficulty, the projects include charming versions of a cat, deer, elephant, seal, walrus, mink, bear and five other creatures. Clear, easy-to-follow explanations of symbols and basic folds help paperfolding enthusiasts successfully complete each project.

Original Dover (1996) publication. Introduction. Explanation of Symbols. Over 300 black-and-white diagrams. 48pp. 8½ × 11. Paperbound.

ALSO AVAILABLE

EASY ORIGAMI, John Montroll. 48pp. 8½ × 11. 27298-2 Pa. \$2.95

BIRDS IN ORIGAMI, John Montroll. 48pp. 8½ × 11. 28341-0 Pa. \$2.95

ORIGAMI SEA LIFE, John Montroll and Robert J. Lang. 256pp. 7 × 10. 26765-2 Pa. \$10.95

PREHISTORIC ORIGAMI, John Montroll. 143pp. 6½ × 9½. 26588-9 Pa. \$9.95

NORTH AMERICAN ANIMALS IN ORIGAMI, John Montroll. 128pp. 8½ × 11. 28667-3 Pa. \$9.95

ORIGAMI INSECTS AND THEIR KIN: STEP-BY-STEP INSTRUCTIONS IN OVER 1500 DIAGRAMS, Robert J. Lang. 160pp. 8½ × 11. 28602-9 Pa. \$9.95

Free Dover Complete Catalog (59069-0) available upon request.

ISBN 0-486-29136-7

